



US00D647998S

(12) **United States Design Patent**
Nelson et al.

(10) **Patent No.:** **US D647,998 S**
(45) **Date of Patent:** **** Nov. 1, 2011**

(54) **CONTAINER FOR A FLUID DISPENSING DEVICE**

(75) Inventors: **Cory J. Nelson**, Racine, WI (US); **Jose M. Arevalo**, Racine, WI (US); **Jim Stango**, Chicago, IL (US); **Aaron B. Eiger**, Chicago, IL (US)

(73) Assignee: **S.C. Johnson & Son, Inc.**, Racine, WI (US)

(**) Term: **14 Years**

(21) Appl. No.: **29/364,040**

(22) Filed: **Jun. 17, 2010**

Related U.S. Application Data

(63) Continuation-in-part of application No. 29/338,740, filed on Jun. 17, 2009.

(51) **LOC (9) Cl.** **23-01**

(52) **U.S. Cl.** **D23/225**; D9/416; D9/522

(58) **Field of Classification Search** D23/225;
D9/416, 522, 526, 739, 743; 222/94, 321.1,
222/136, 144; 239/154, 310, 337, 332-333,
239/302, 308, 316

See application file for complete search history.

(56) **References Cited**

U.S. PATENT DOCUMENTS

- D166,052 S * 2/1952 Smith D9/522
- 3,141,574 A * 7/1964 Donoghue 222/157
- 5,152,431 A 10/1992 Gardner et al.
- 5,439,141 A 8/1995 Clark et al.
- 5,529,216 A 6/1996 Klima et al.
- D373,537 S * 9/1996 Schirado D9/572
- 5,788,125 A 8/1998 Steiner et al.
- 5,823,391 A * 10/1998 Klauke et al. 222/94
- 5,836,479 A 11/1998 Klima et al.
- 5,871,122 A 2/1999 Klima et al.

- 5,890,624 A 4/1999 Klima et al.
- 5,906,318 A 5/1999 Gurko, III et al.
- 5,944,223 A 8/1999 Klima et al.
- 5,947,332 A 9/1999 Klima et al.
- 6,073,808 A 6/2000 Klima et al.
- 6,123,230 A 9/2000 Klima, Jr. et al.
- 6,152,326 A 11/2000 Klima, Jr. et al.
- 6,182,865 B1 2/2001 Bunschoten et al.
- 6,319,453 B1 11/2001 Klima, Jr. et al.
- 6,375,041 B1 4/2002 Klima et al.
- 6,431,402 B1 8/2002 Klima et al.
- 6,540,109 B1 4/2003 Klima et al.

(Continued)

FOREIGN PATENT DOCUMENTS

EP 1726532 11/2006

(Continued)

Primary Examiner — Robin V Webster

(74) *Attorney, Agent, or Firm* — Boyle Fredrickson, S.C.

(57) **CLAIM**

The ornamental design for a container for a fluid dispensing device, as shown and described.

DESCRIPTION

FIG. 1 is an isometric view of a container according to one embodiment of the present invention, viewed from above, in front of, and from the right side of the container;

FIG. 2 is another isometric view of the container of FIG. 1, viewed from below, behind, and from the left side thereof;

FIG. 3 is a right side elevation view of the container of FIG. 1;

FIG. 4 is a left side elevation view of the container of FIG. 1;

FIG. 5 is front elevation view of the container of FIG. 1;

FIG. 6 is a rear elevation view of the container of FIG. 1;

FIG. 7 is a top plan view of the container of FIG. 1; and,

FIG. 8 is a bottom plan of the container of FIG. 1.

The broken lines represent environmental structure and form no part of the claimed design.

1 Claim, 8 Drawing Sheets

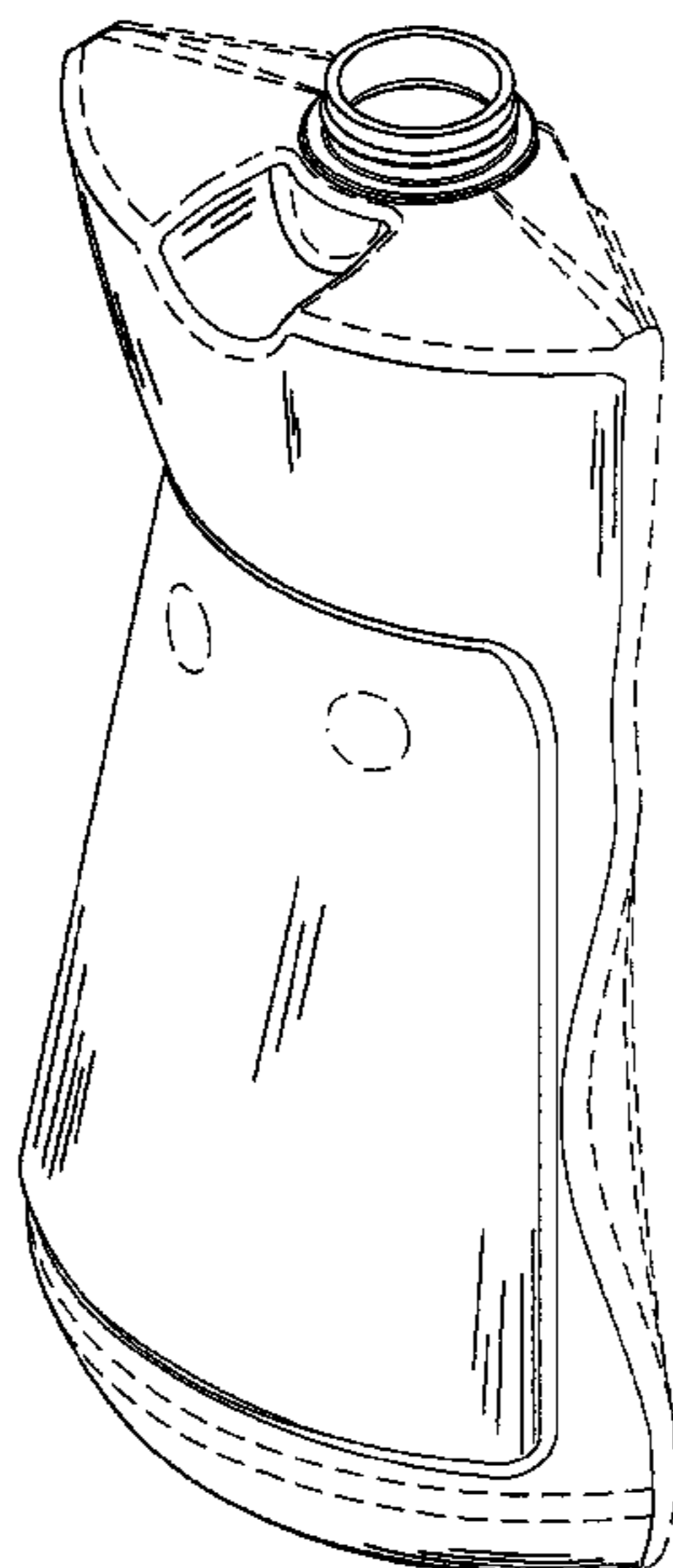

US D647,998 S

Page 2

U.S. PATENT DOCUMENTS

6,568,562 B1 5/2003 Klima, Jr. et al.
6,659,311 B2 12/2003 Prueter
D514,953 S * 2/2006 Akopyan D9/739
7,331,486 B2 2/2008 Mon et al.
7,370,813 B2 5/2008 Hubmann et al.
D614,046 S * 4/2010 Piro D9/743
D619,465 S * 7/2010 Synder D9/522
D626,434 S * 11/2010 Massin et al. D9/743
2003/0038186 A1 2/2003 Klima et al.
2007/0189834 A1 8/2007 McKay
2008/0001002 A1 1/2008 Garon

2008/0011779 A1 1/2008 Klima et al.
2008/0047921 A1 2/2008 Klabbers et al.
2008/0049414 A1 2/2008 McKay
2008/0049415 A1 2/2008 McKay
2008/0062674 A1 3/2008 McKay

FOREIGN PATENT DOCUMENTS

WO WO9530491 11/1995
WO WO2006043935 4/2006
WO WO2008118446 10/2008

* cited by examiner

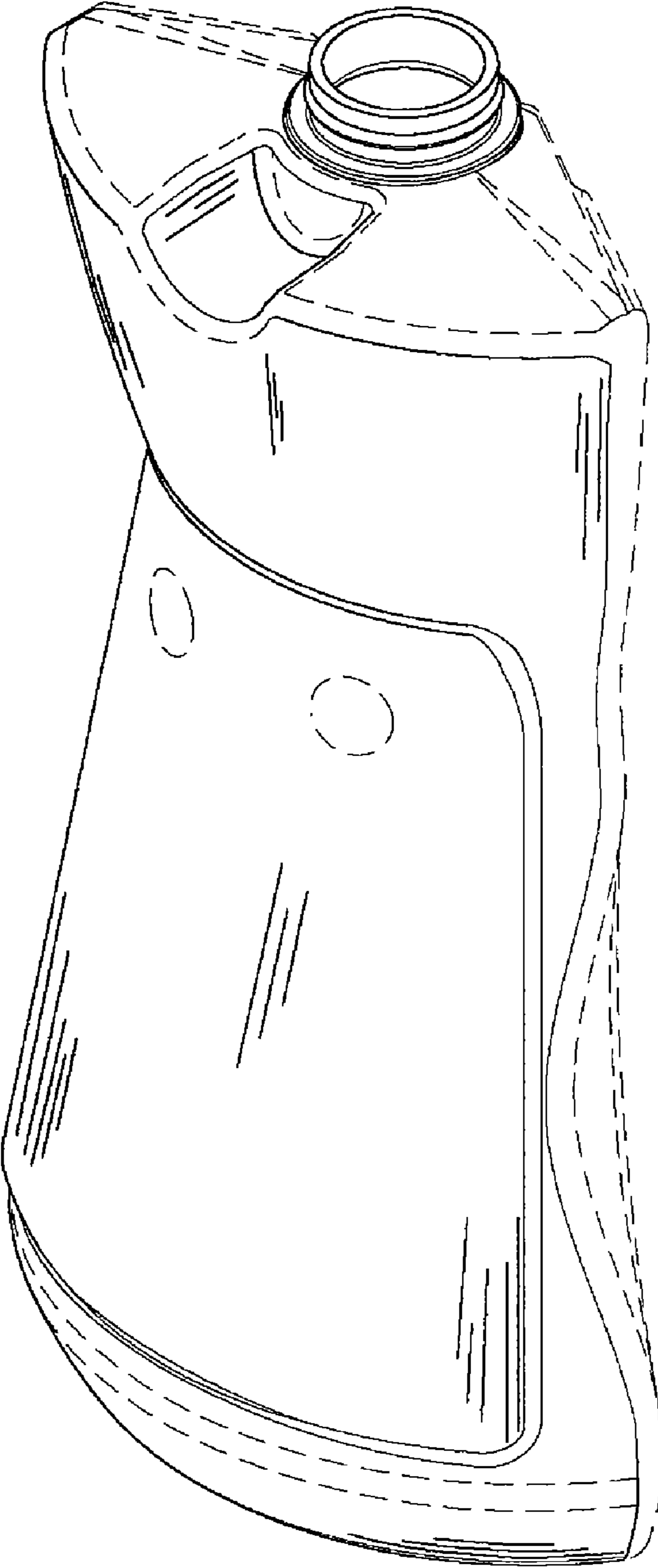

FIG. 1

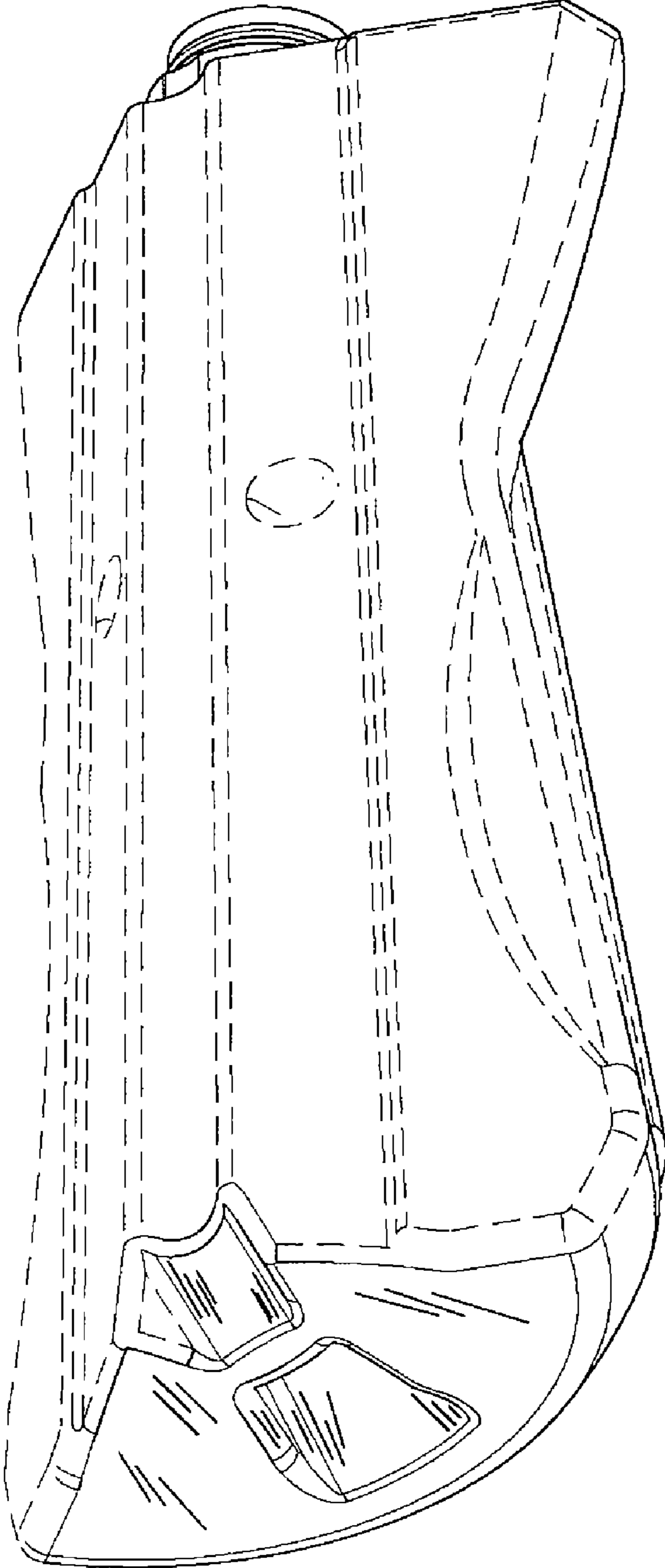

FIG. 2

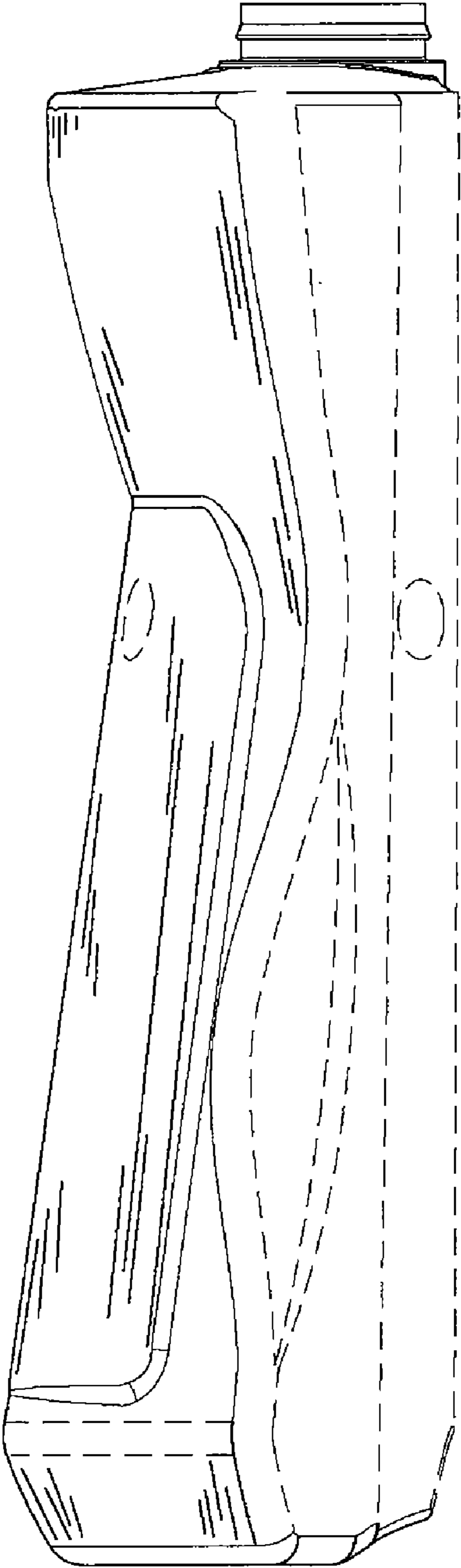

FIG. 3

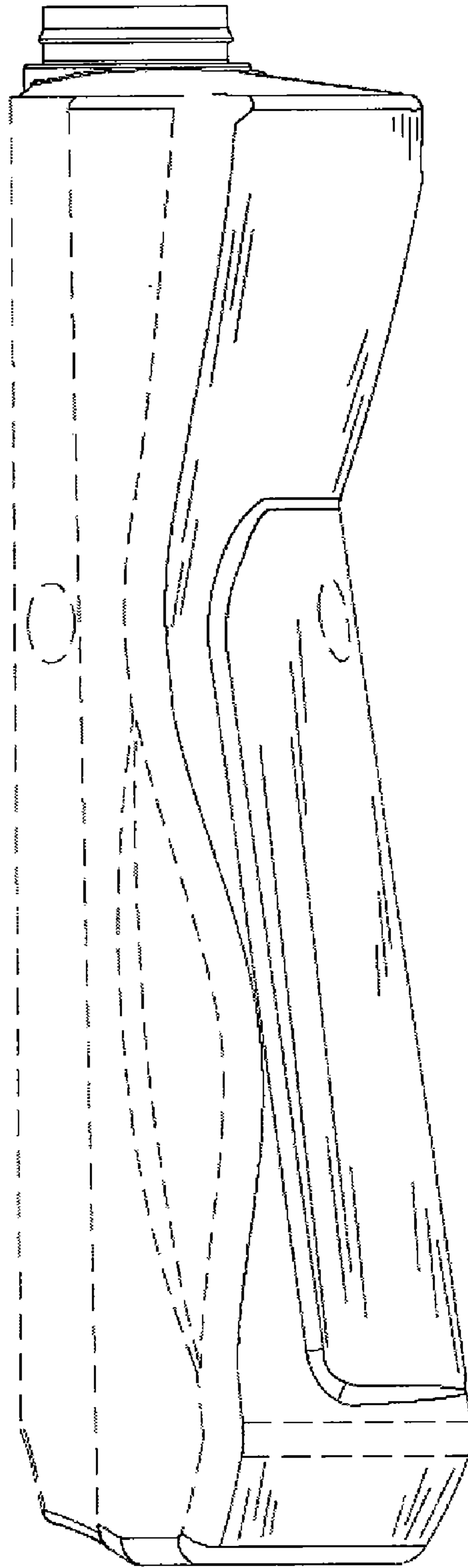

FIG. 4

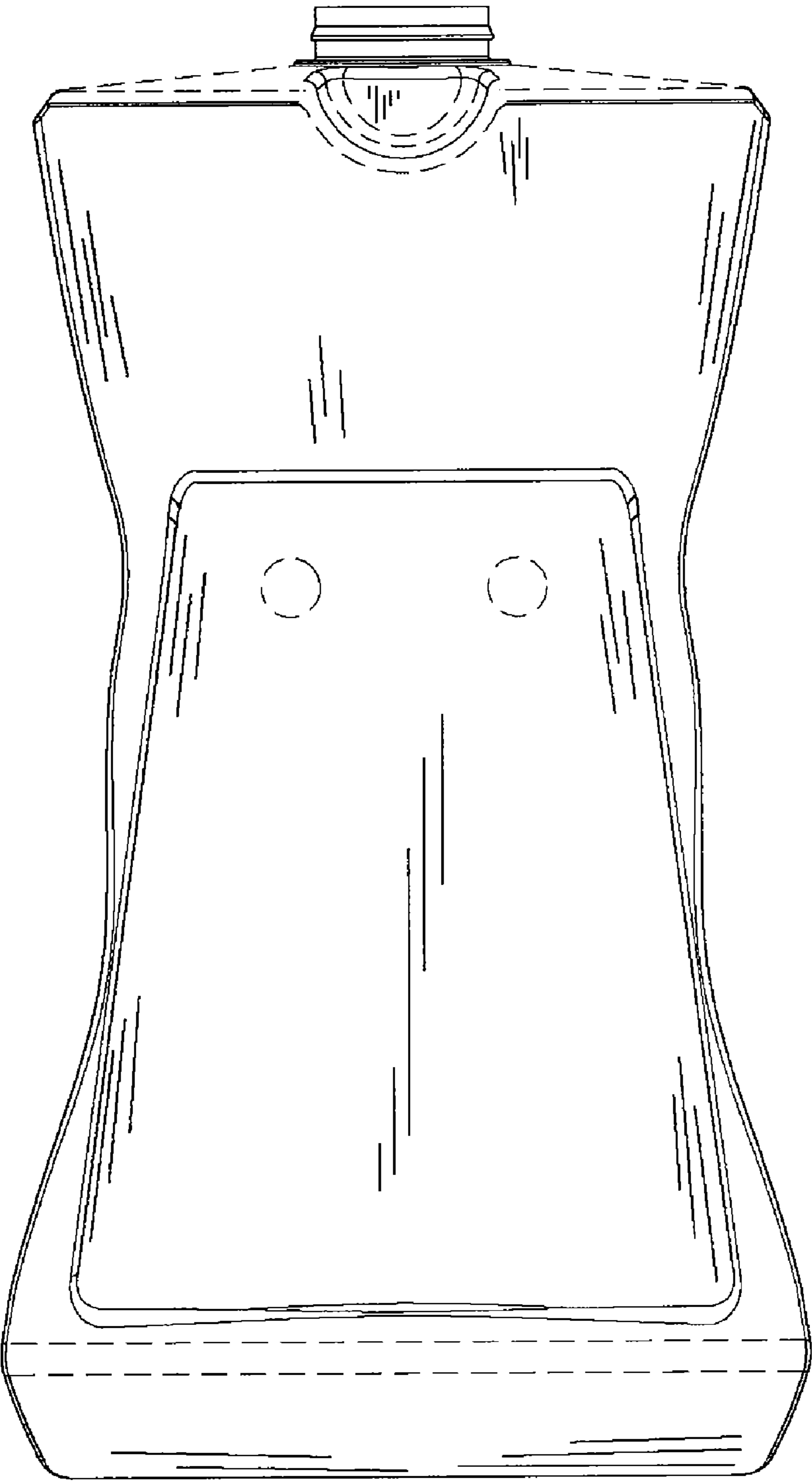

FIG. 5

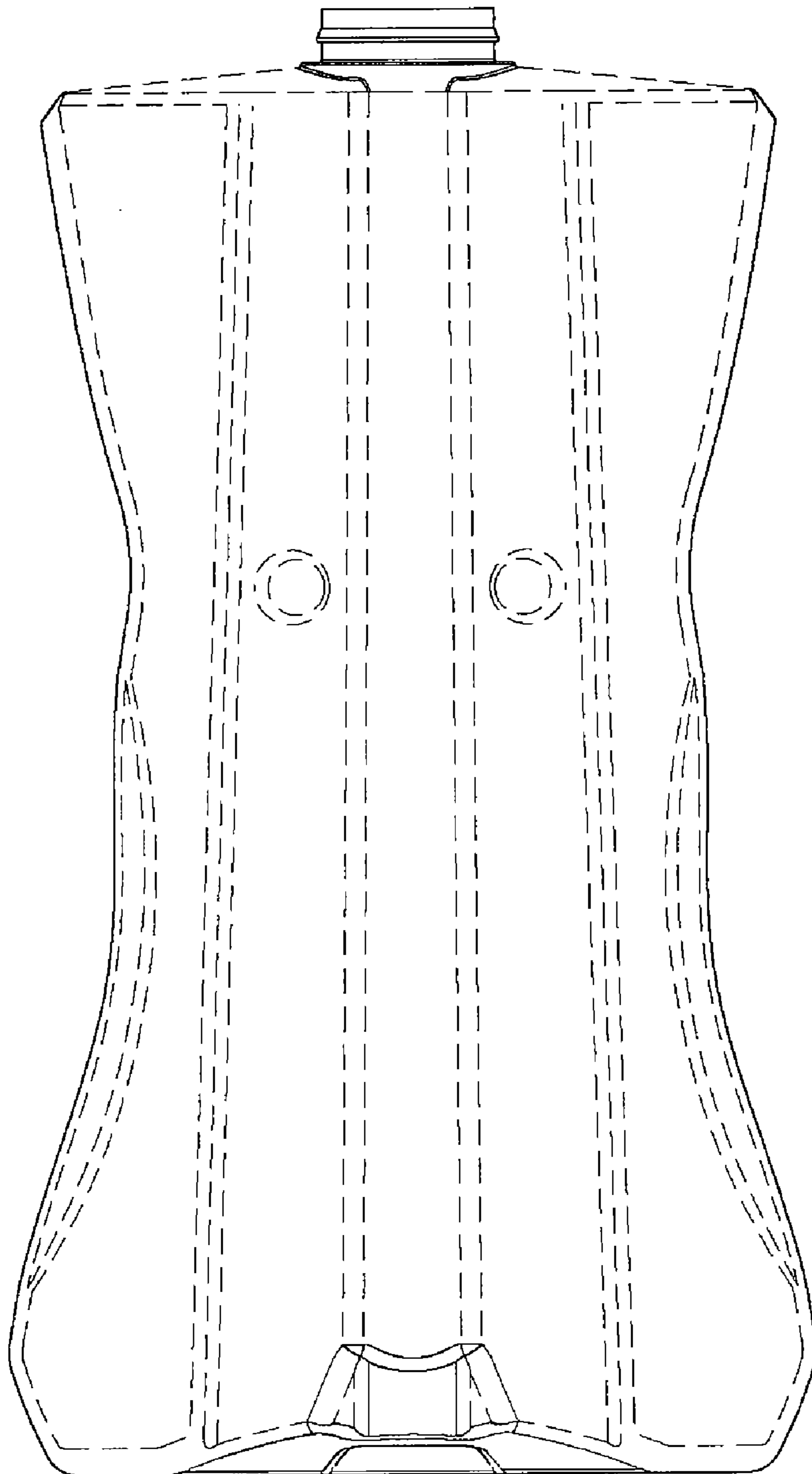

FIG. 6

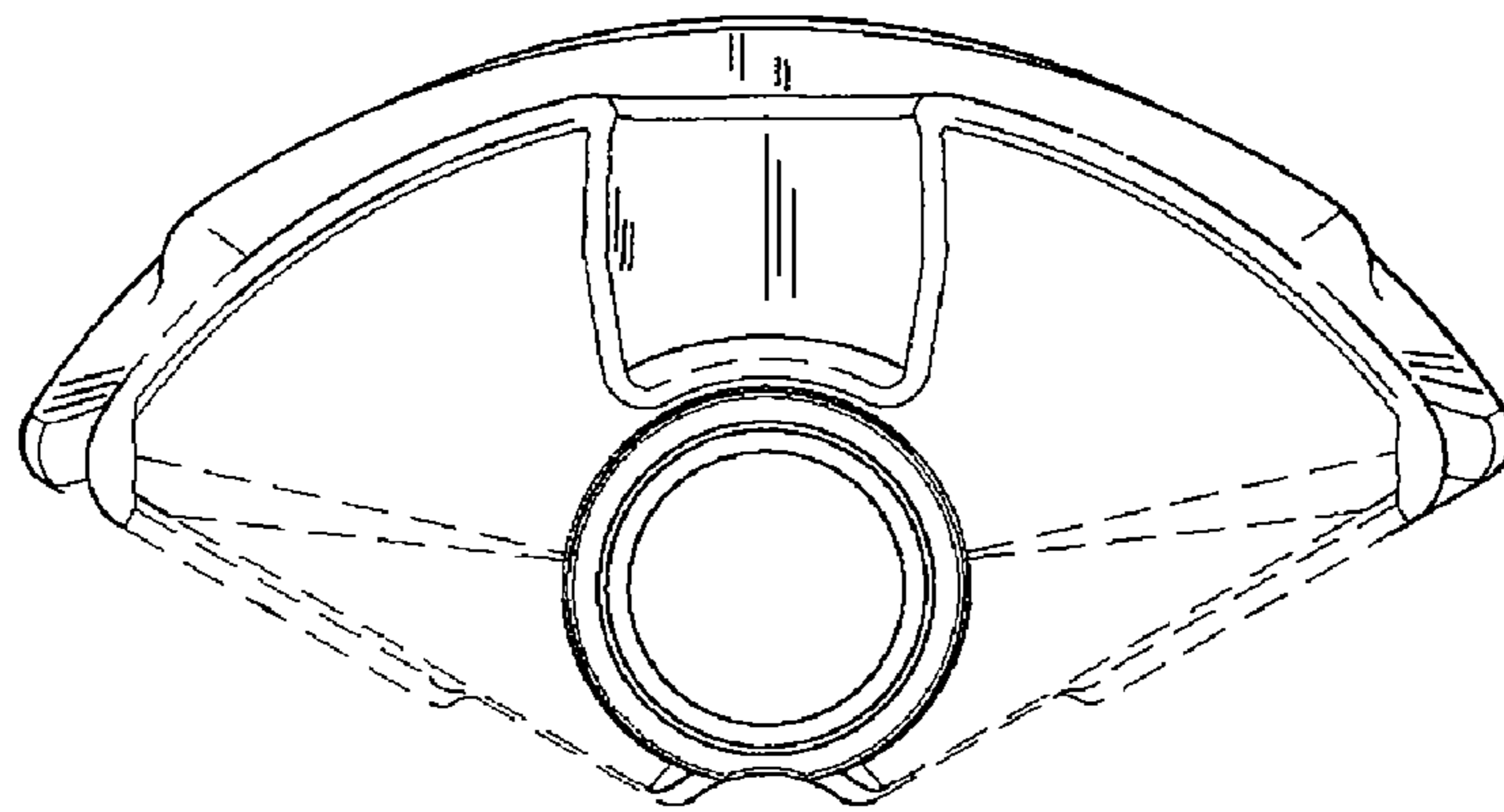

FIG. 7

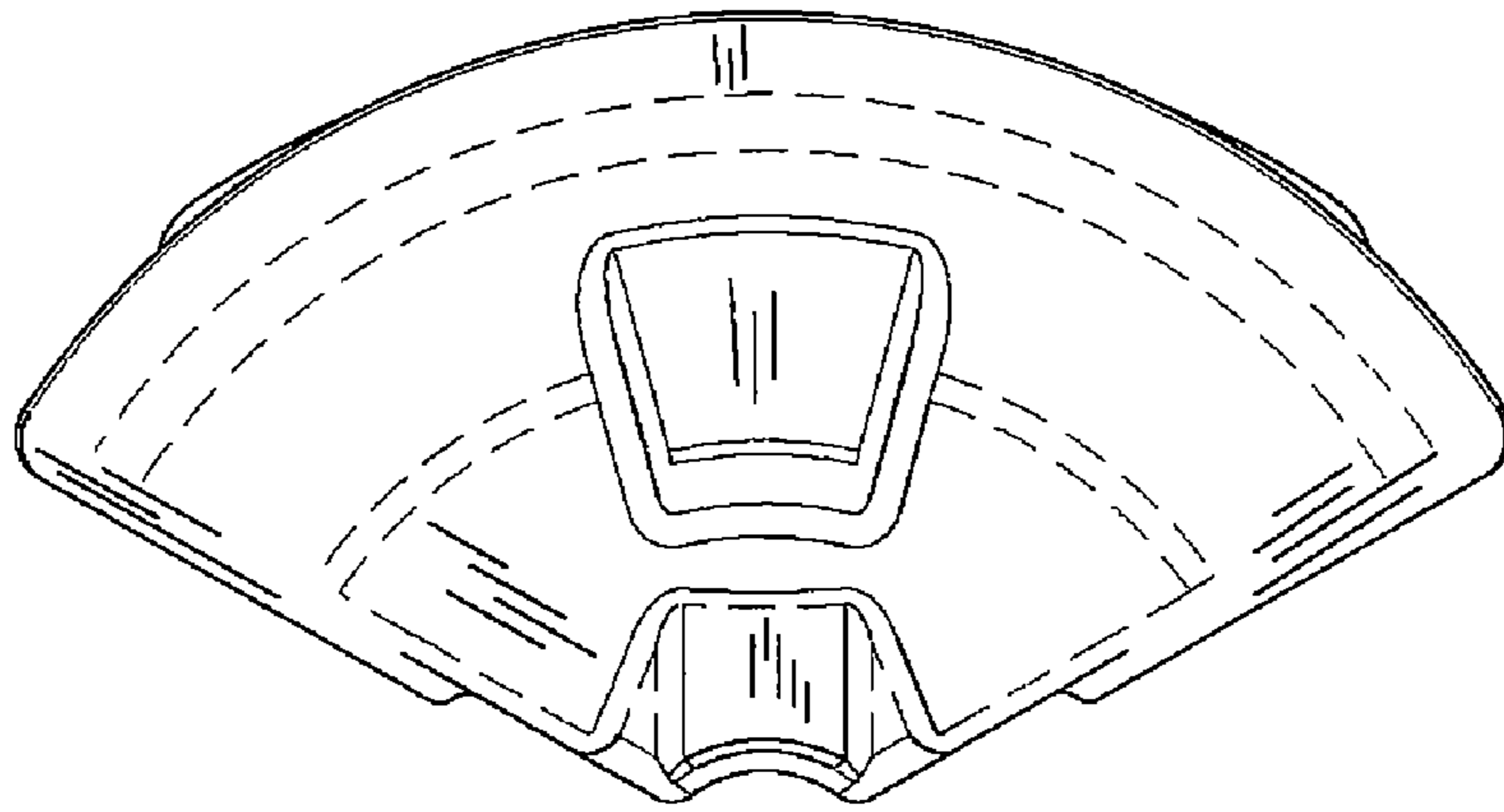

FIG. 8