



US00D647944S

(12) **United States Design Patent**
Jannard et al.

(10) **Patent No.:** **US D647,944 S**

(45) **Date of Patent:** **** Nov. 1, 2011**

(54) **CAMERA COMPONENT**

(75) Inventors: **James H. Jannard**, Las Vegas, NV
(US); **Matthew Gene Tremblay**, Laguna
Beach, CA (US); **Peter Jarred Land**,
Lake Forest, CA (US)

(73) Assignee: **Red.com, Inc.**, Lake Forest, CA (US)

(**) Term: **14 Years**

(21) Appl. No.: **29/348,315**

(22) Filed: **Dec. 18, 2009**

(51) **LOC (9) Cl.** **16-05**

(52) **U.S. Cl.** **D16/237; D13/103**

(58) **Field of Classification Search** D13/103,
D13/119; D16/237; 429/96-100, 163-17
See application file for complete search history.

(56) **References Cited**

U.S. PATENT DOCUMENTS

D362,424 S * 9/1995 Sumita et al. D13/103
D414,159 S * 9/1999 Deslyper et al. D13/103
D478,608 S * 8/2003 Briks et al. D16/237

D491,137 S * 6/2004 Suzuki D13/103
D503,673 S * 4/2005 Rosengrant D13/103
D556,680 S * 12/2007 Matsumoto D13/103

* cited by examiner

Primary Examiner — Nanda Bondade

(74) *Attorney, Agent, or Firm* — Gregory K. Nelson

(57) **CLAIM**

The ornamental design for a camera component, as shown
and described.

DESCRIPTION

FIG. 1 is a front perspective view of the camera component of
the present invention;

FIG. 2 is a front elevational view thereof;

FIG. 3 is a rear elevational view thereof;

FIG. 4 is a left-side elevational view thereof, the right-side
elevational view being a mirror image thereof;

FIG. 5 is a bottom plan view thereof; and,

FIG. 6 is a top plan view thereof.

The broken line showing on the drawing disclosure is for
illustrative purposes only and forms no part of the claimed
design.

1 Claim, 3 Drawing Sheets

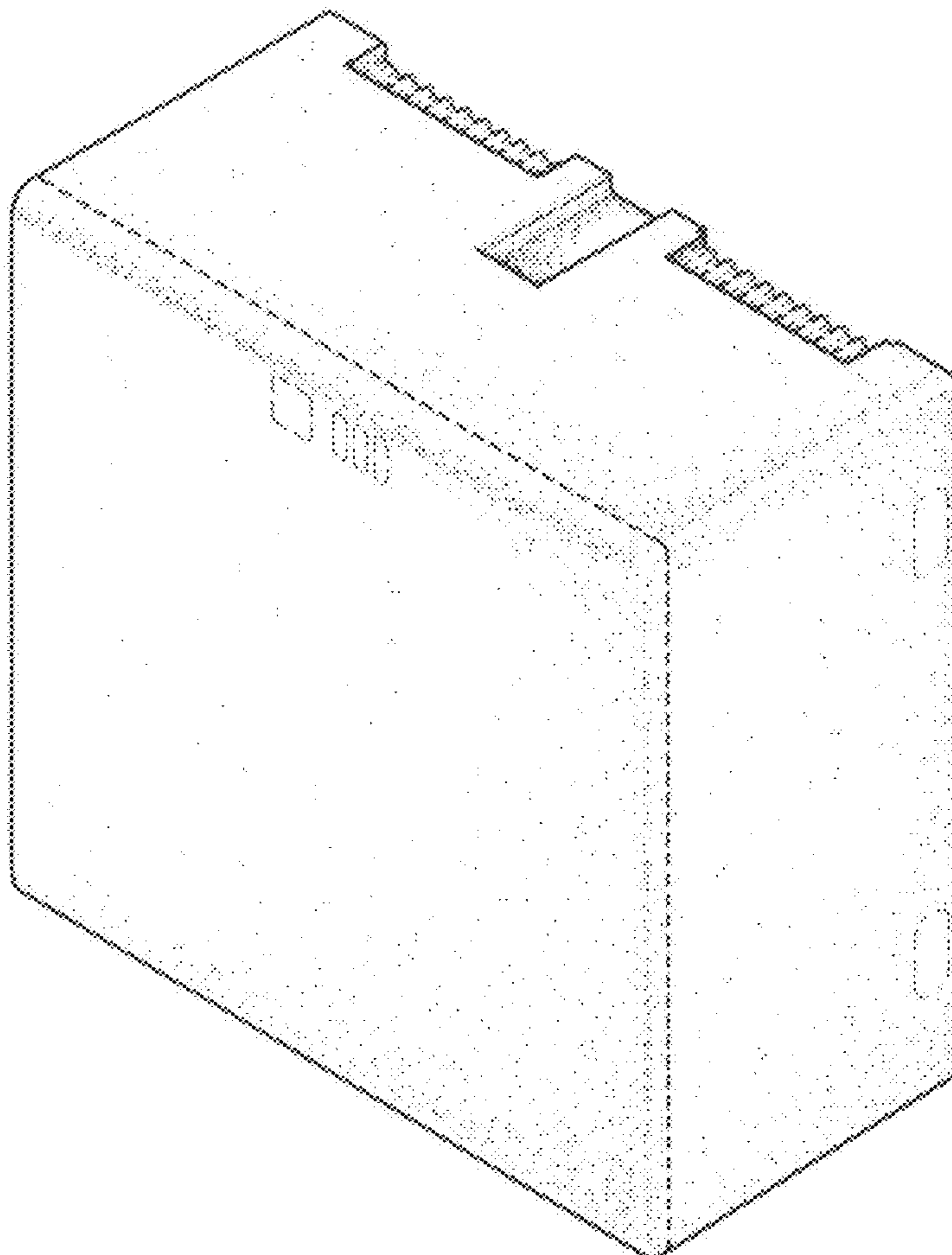

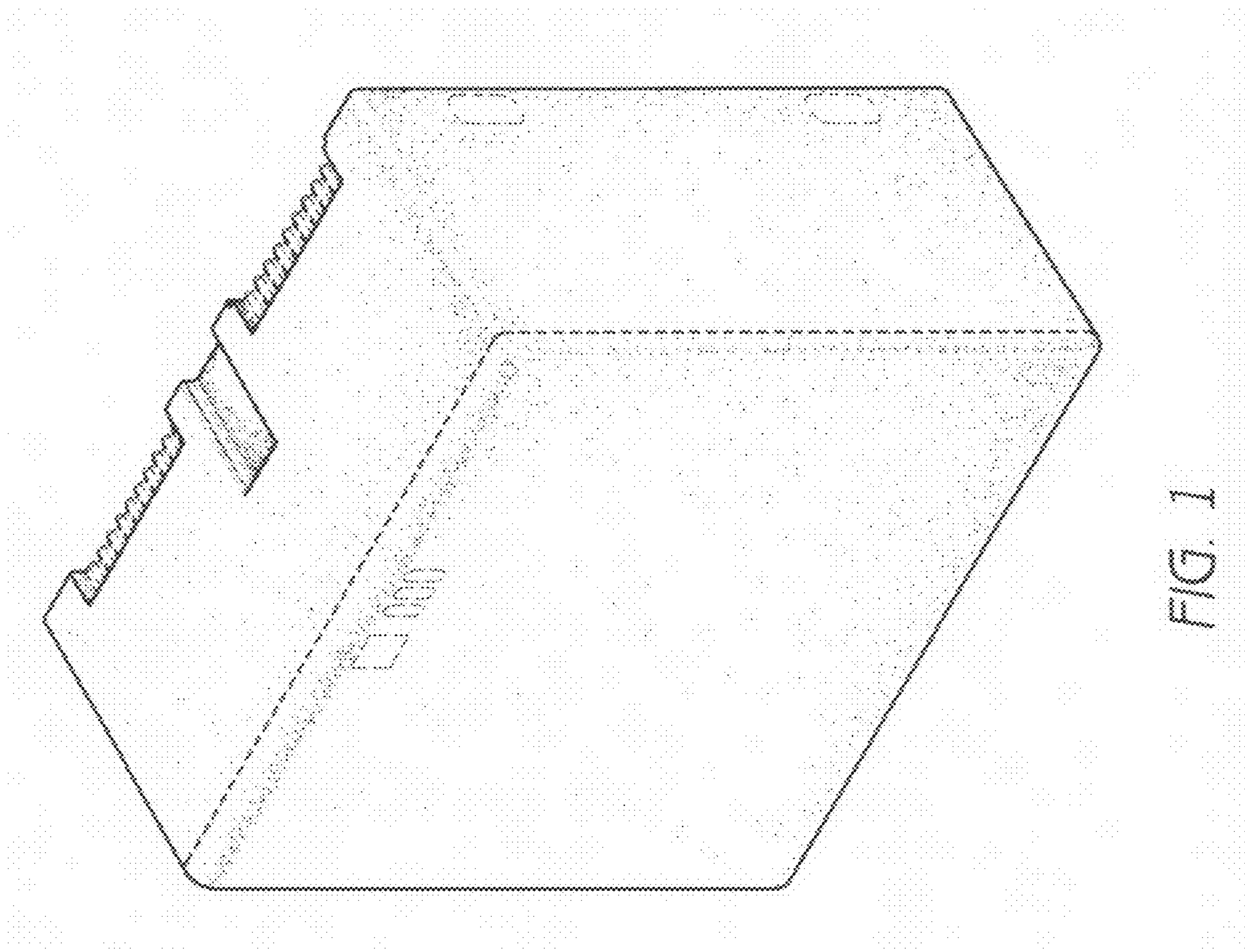

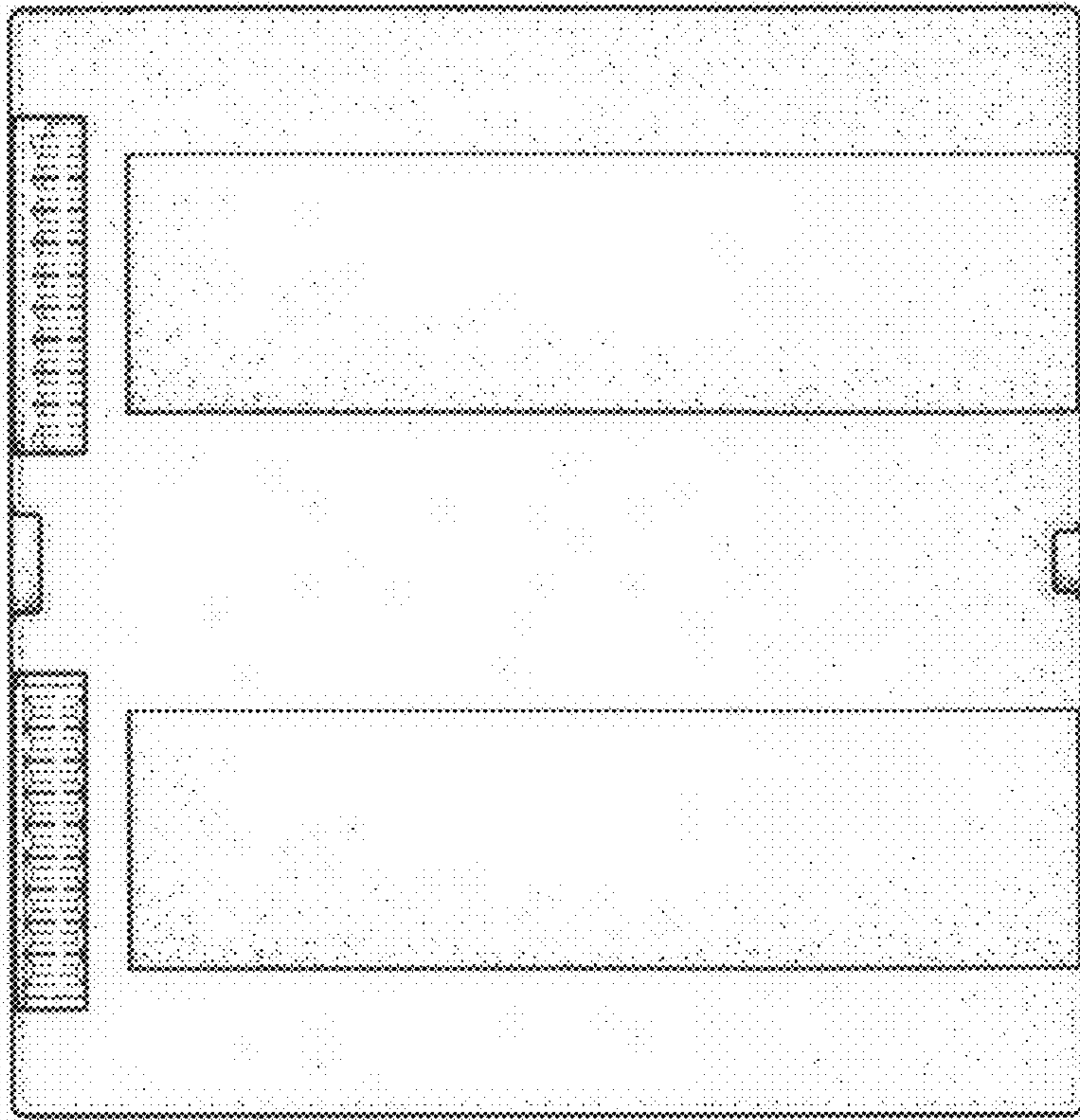

FIG. 2

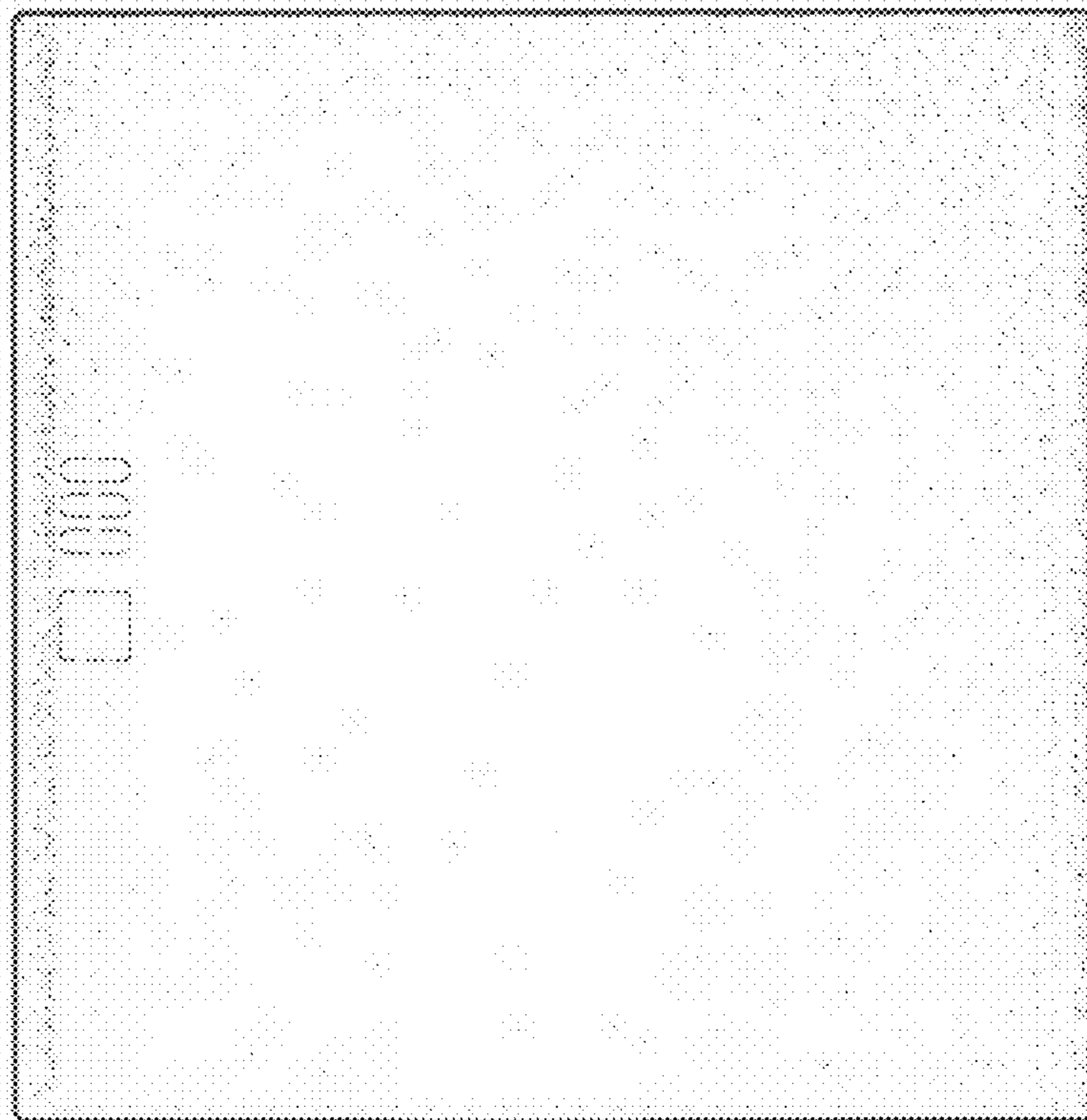

FIG. 3

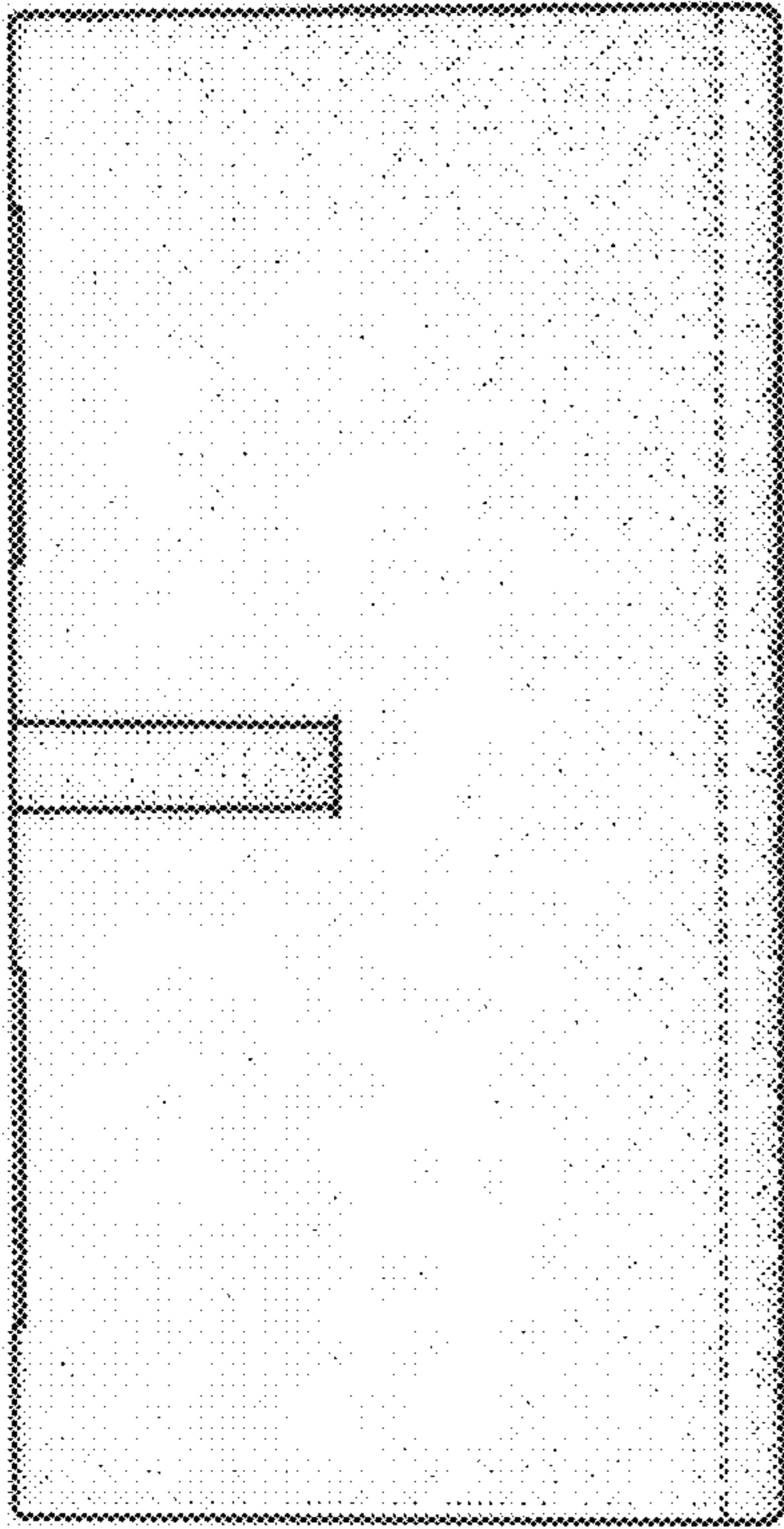

FIG. 5

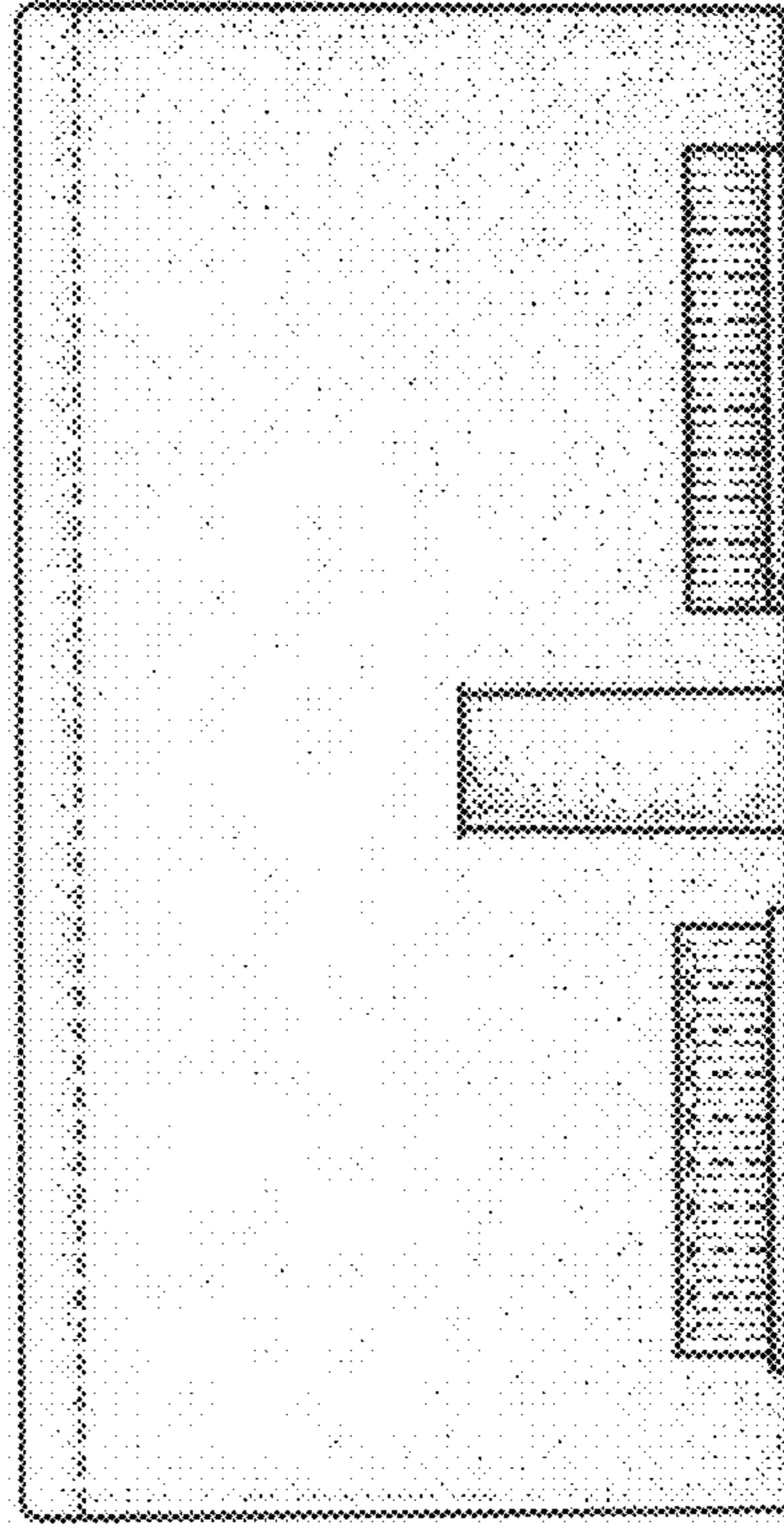

FIG. 6

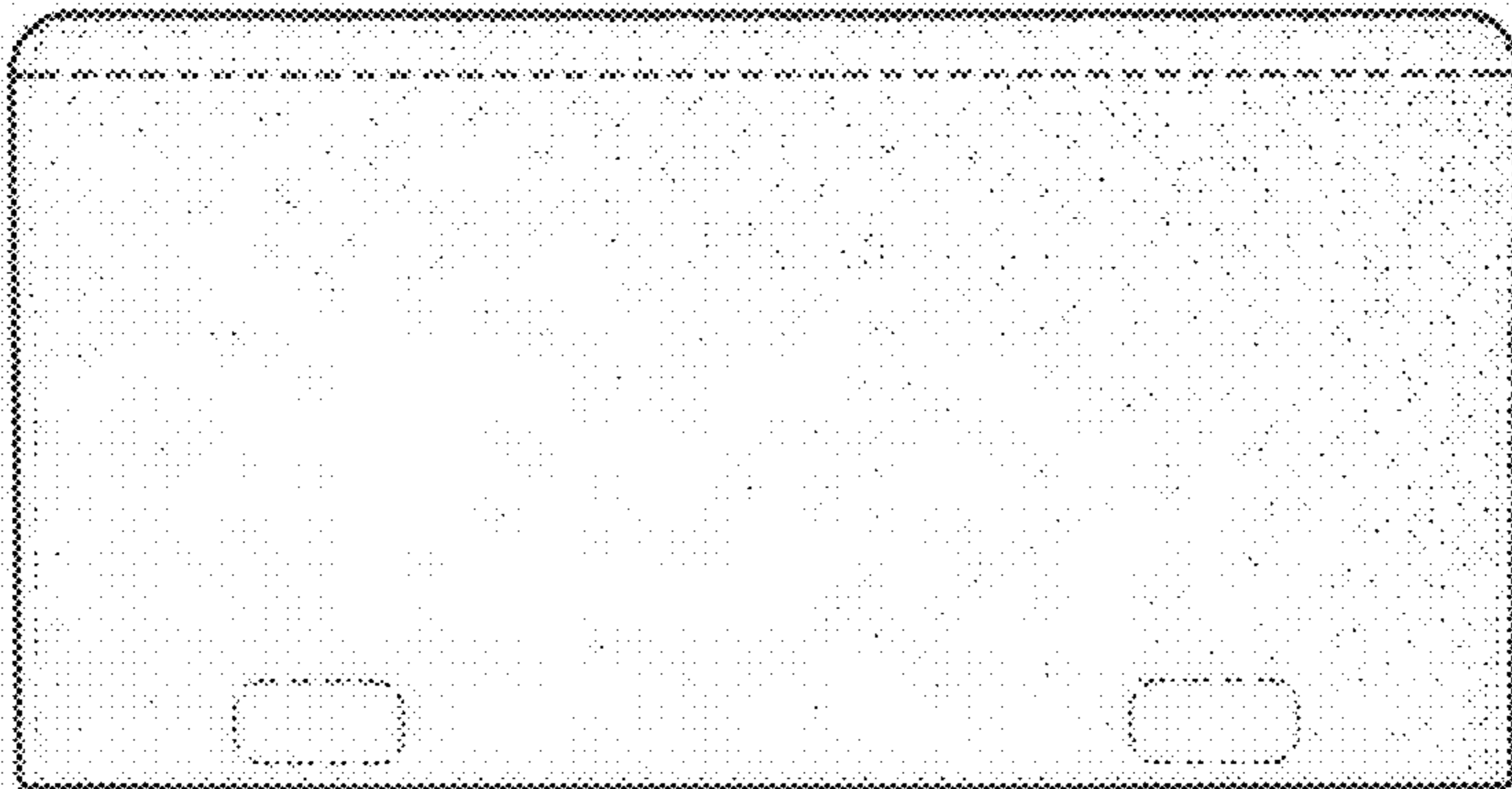

FIG. 4