



US00D647918S

(12) **United States Design Patent**
Ledbetter et al.

(10) **Patent No.:** **US D647,918 S**

(45) **Date of Patent:** **** Nov. 1, 2011**

(54) **ELECTRONIC HOUSING**

(75) Inventors: **Carl J. Ledbetter**, Mercer Island, WA (US); **Dustin R. Brown**, Chicago, IL (US); **John Ikeda**, Seattle, WA (US); **Scott Harold Wilson**, Chicago, IL (US); **Claire M. Gerhardt**, Seattle, WA (US); **Stephen Christopher**, Chicago, IL (US)

(73) Assignee: **Microsoft Corporation**, Redmond, WA (US)

(**) Term: **14 Years**

(21) Appl. No.: **29/362,858**

(22) Filed: **Jun. 1, 2010**

(51) **LOC (9) Cl.** **14-03**

(52) **U.S. Cl.** **D14/496; D14/203.3**

(58) **Field of Classification Search** D14/496, D14/401, 435, 474, 483, 217, 137, 138, 160, D14/168, 356, 203.1-203.8, 507; 345/156, 345/169, 173-179, 905; 715/727-729, 864; 710/1, 5, 8; 713/1, 600; 455/1.1, 1.7, 73, 455/344-347, 93, 95, 3.01-3.06, 550.1, 573.1; 370/342-344; 369/1, 2, 6-12; 463/43-47; 273/148 B; D21/324-333

See application file for complete search history.

(56) **References Cited**

U.S. PATENT DOCUMENTS

D287,243 S	12/1986	Tope	
D380,447 S	7/1997	Chen et al.	
5,649,839 A	7/1997	Yu	
D390,202 S	2/1998	Goto	
5,914,707 A *	6/1999	Kono	345/173
D416,264 S	11/1999	Althans et al.	
D433,681 S	11/2000	Jean et al.	
6,275,882 B1 *	8/2001	Cheever et al.	710/302
D458,218 S	6/2002	Reynolds	
D490,372 S	5/2004	Lee et al.	

D496,049 S	9/2004	Heinz et al.	
D497,906 S	11/2004	Kellom et al.	
D499,109 S	11/2004	Chen et al.	
6,908,387 B2 *	6/2005	Hedrick et al.	463/31
6,955,606 B2 *	10/2005	Taho et al.	463/43
D512,419 S	12/2005	Juszkiewicz et al.	
D514,076 S	1/2006	Albano et al.	
D514,118 S	1/2006	Christianson	
D526,321 S	8/2006	Hayes et al.	
7,090,582 B2 *	8/2006	Danieli et al.	463/35
D540,752 S	4/2007	Hayes et al.	
D541,233 S	4/2007	Hayes et al.	
D543,954 S	6/2007	Hayes et al.	
D543,955 S	6/2007	Hayes et al.	
D543,956 S	6/2007	Hayes et al.	
D558,788 S *	1/2008	Yu et al.	D14/496
D566,704 S *	4/2008	Cutting	D14/313

(Continued)

OTHER PUBLICATIONS

Images of the Xbox 360 game console, 1 sheet, Microsoft Corporation, 2005.

Primary Examiner — Prabhakar Deshmukh

(74) *Attorney, Agent, or Firm* — Banner & Witcoff, Ltd.

(57) **CLAIM**

The ornamental design for an electronic housing, as shown and described.

DESCRIPTION

FIG. 1 is a front perspective view of an electronic housing showing our new design;

FIG. 2 is a top view thereof;

FIG. 3 is a bottom view thereof;

FIG. 4 is a front view thereof;

FIG. 5 is a rear view thereof;

FIG. 6 is a left side view thereof; and,

FIG. 7 is a right side view thereof.

The broken line showings are for environmental purposes only and form no part of the claimed design.

1 Claim, 5 Drawing Sheets

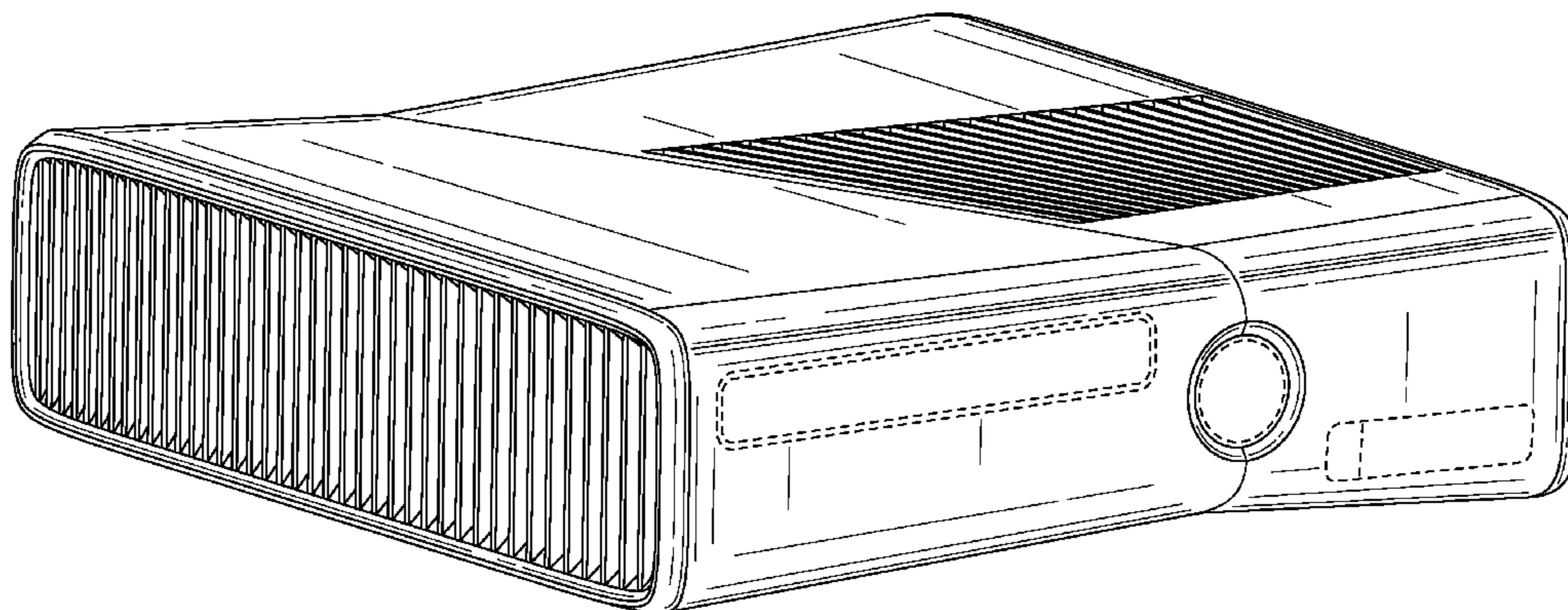

US D647,918 S

Page 2

U.S. PATENT DOCUMENTS

D569,917 S	5/2008	Del Castillo et al.		D612,868 S *	3/2010	Morabito	D14/496
D606,094 S *	12/2009	Kimura	D14/496	D630,228 S *	1/2011	Kim	D14/496
D611,470 S *	3/2010	Andre et al.	D14/341	2006/0146492 A1	7/2006	Reents et al.	
							* cited by examiner

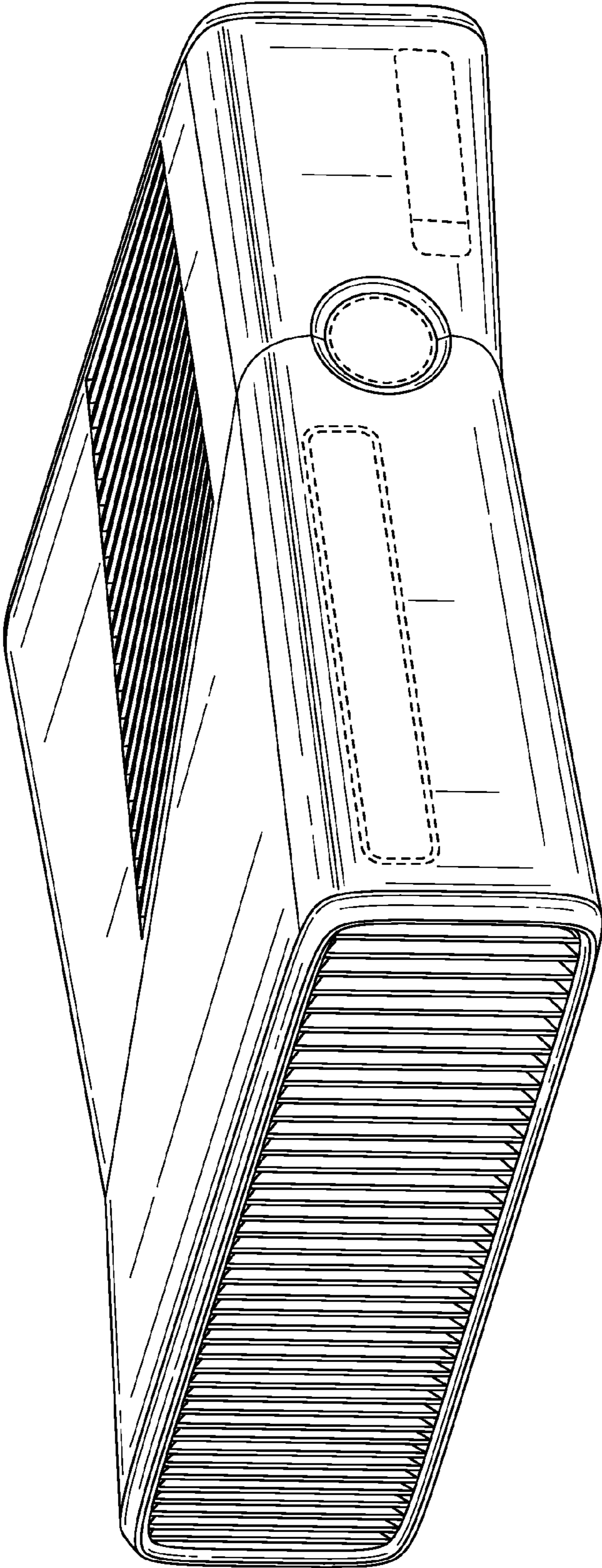

FIG. 1

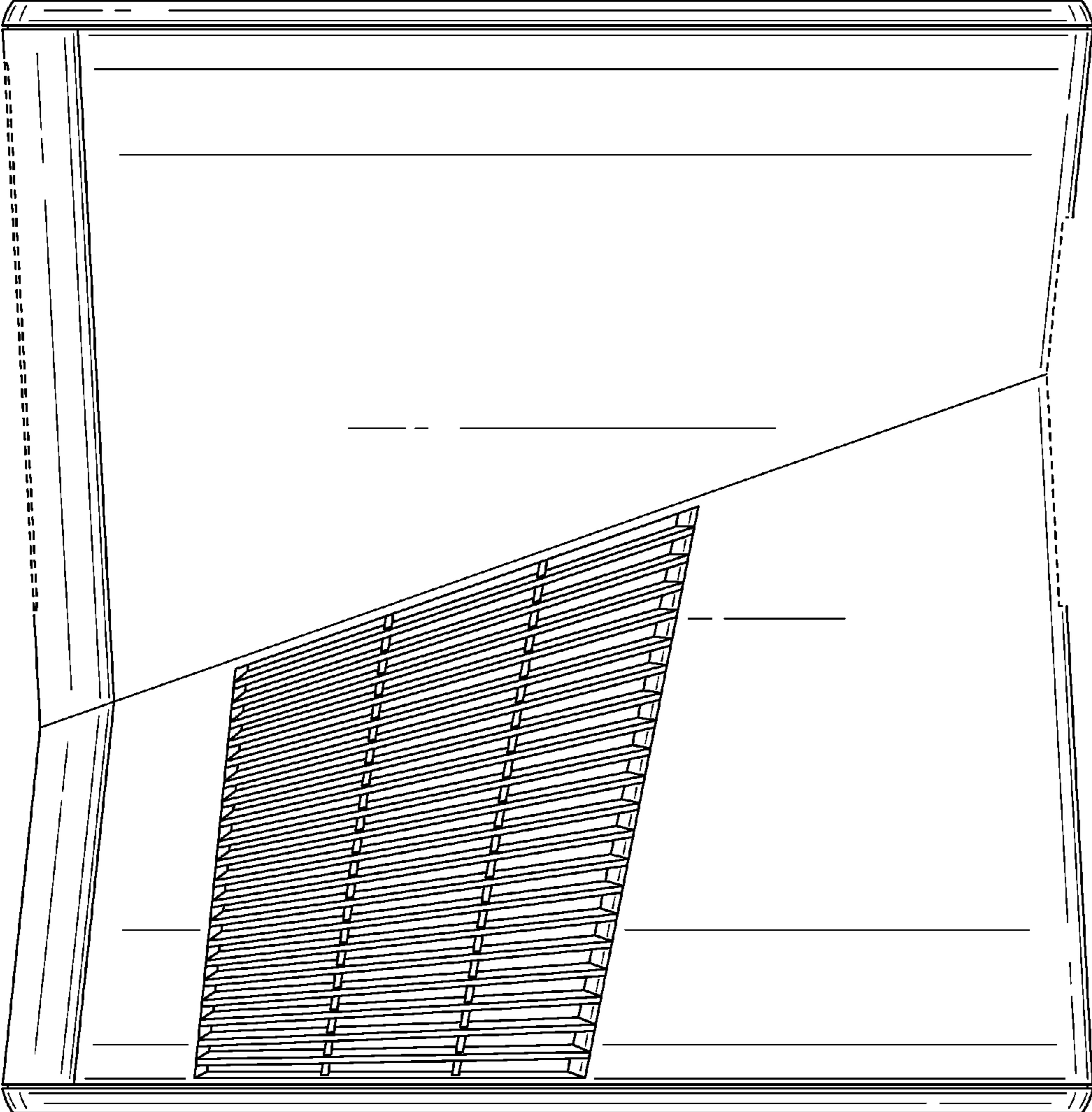

FIG. 2

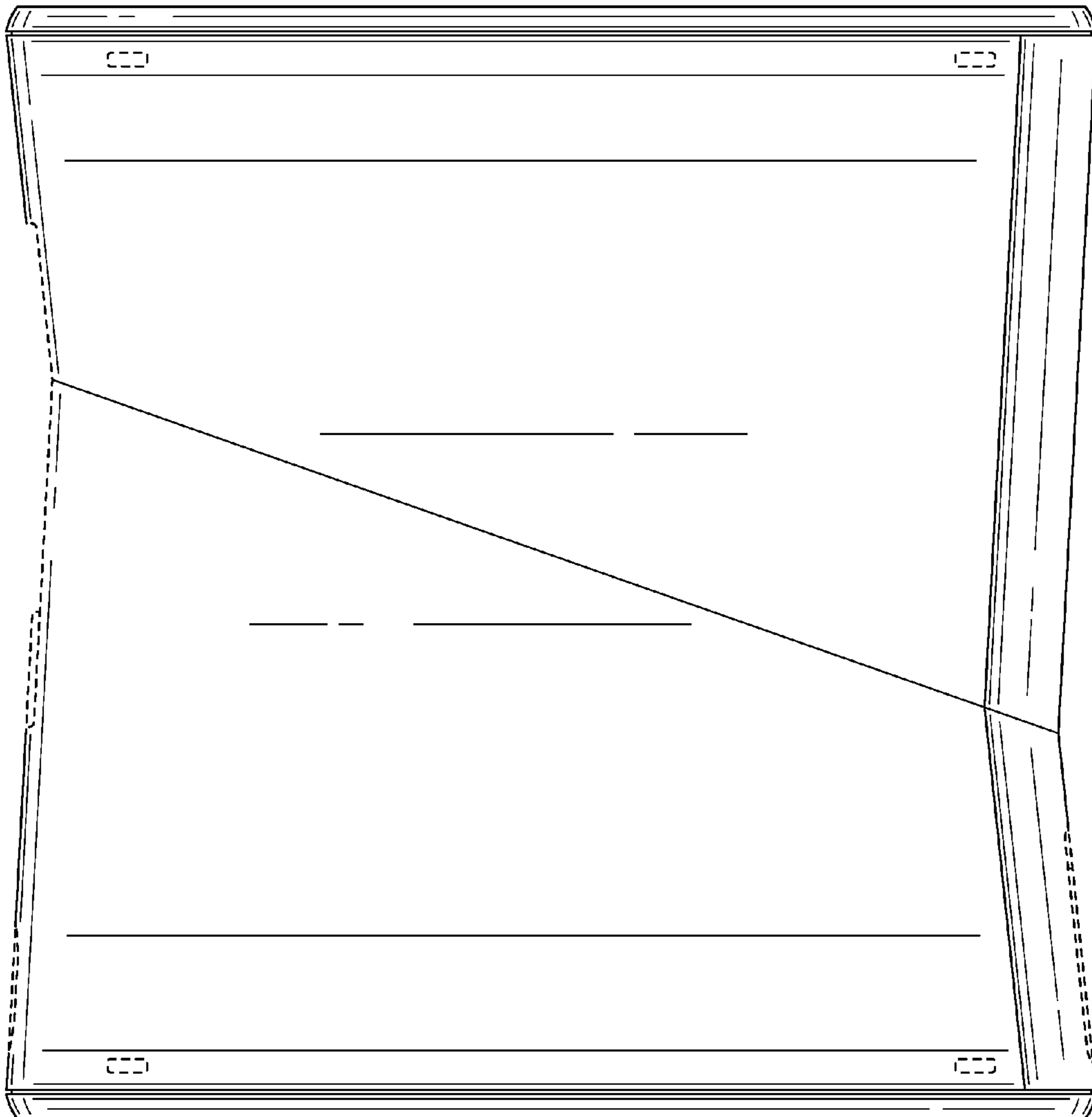

FIG. 3

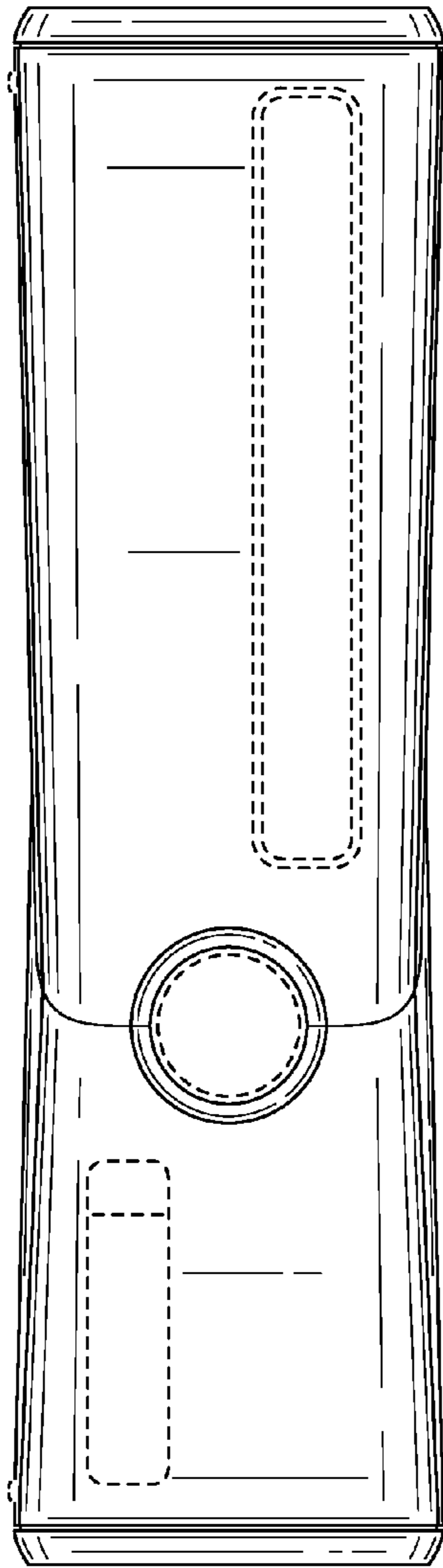

FIG. 4

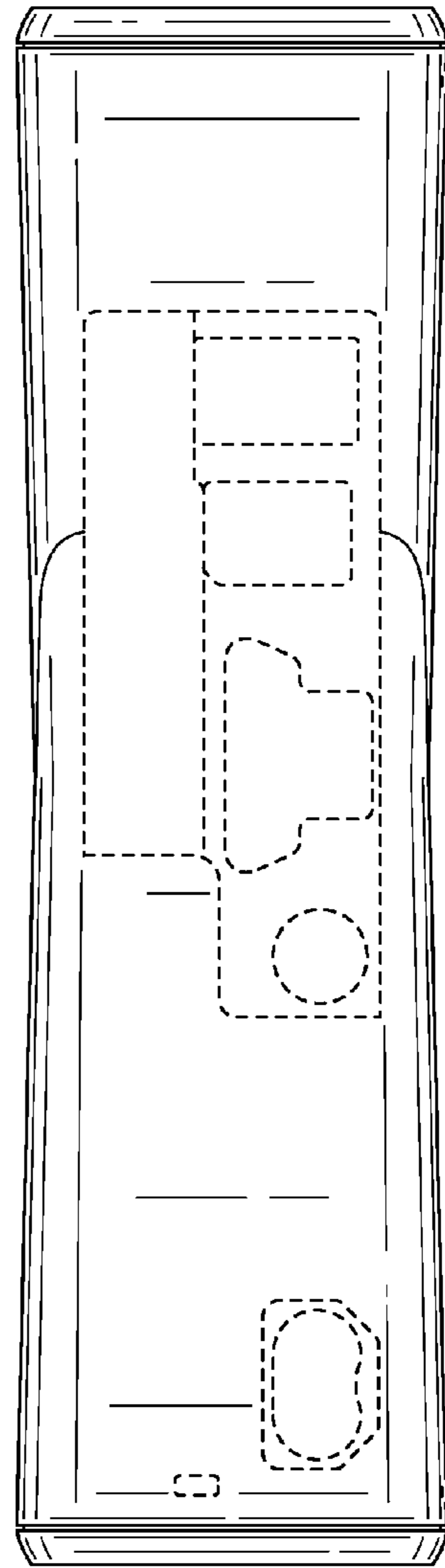

FIG. 5

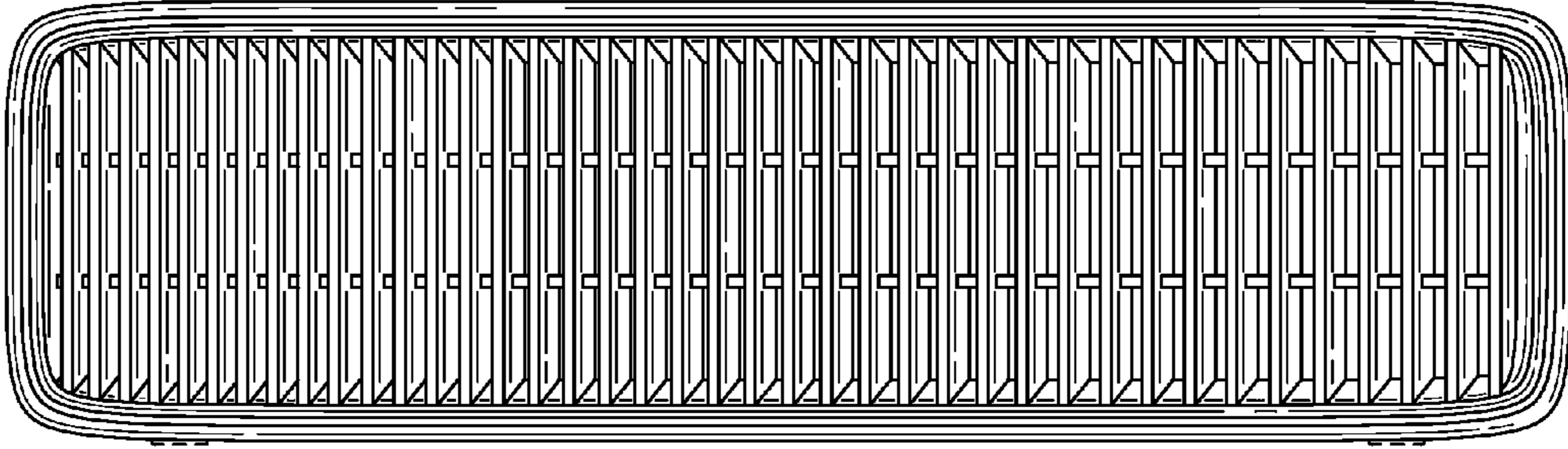

FIG. 6

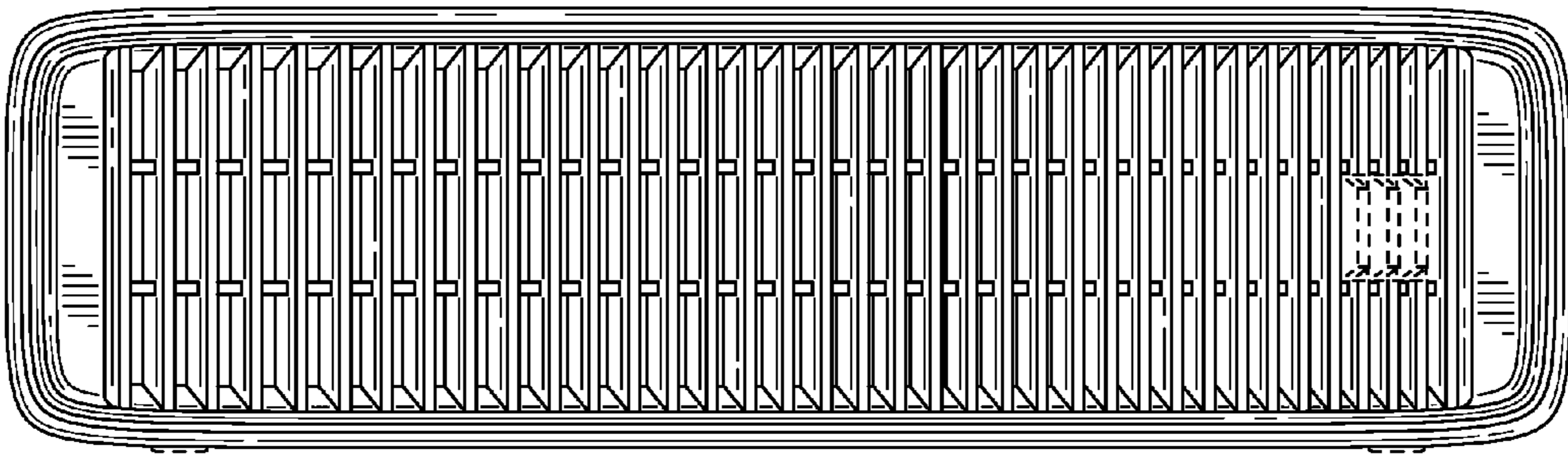

FIG. 7