



US00D647882S

(12) **United States Design Patent**
Kim et al.

(10) **Patent No.:** **US D647,882 S**
(45) **Date of Patent:** **** Nov. 1, 2011**

(54) **REMOTE CONTROLLER FOR TV RECEIVER**

(75) Inventors: **Jae-Hyung Kim**, Kyunggi-do (KR);
Jin-Wook Kim, Gyeongsangbuk-do
(KR); **Bo-Kyung Seong**, Seoul (KR)

(73) Assignee: **Samsung Electronics Co., Ltd.**,
Kyunggi-do (KR)

(**) Term: **14 Years**

(21) Appl. No.: **29/373,291**

(22) Filed: **Mar. 25, 2011**

(30) **Foreign Application Priority Data**

Dec. 20, 2010 (KR) 30-2010-0054964

(51) **LOC (9) Cl.** **14-03**

(52) **U.S. Cl.** **D14/218**

(58) **Field of Classification Search** D14/218,
D14/455; D13/168; D21/566; D10/104,
D10/106; 345/169; 348/14.05, 114, 211.99,
348/734; 340/825.24; 341/22; 455/92, 95,
455/128, 151.1-151.4, 352, 355, FOR. 121;
700/65

See application file for complete search history.

(56) **References Cited**

U.S. PATENT DOCUMENTS

D409,201 S	5/1999	Barraza et al.
D515,041 S	2/2006	Yun et al.
D521,459 S	5/2006	Yun et al.
D525,212 S	7/2006	Kim
D531,993 S	11/2006	Choi et al.
D532,779 S	11/2006	Kim et al.
D546,320 S	7/2007	Choi
D551,632 S	9/2007	Kim
D555,107 S	11/2007	Choi et al.
D559,201 S	1/2008	Oh et al.
D559,202 S	1/2008	Sim et al.
D564,977 S	3/2008	Youn et al.

D577,713 S	9/2008	Kim et al.	
D578,967 S *	10/2008	Kumano	D13/168
D583,363 S	12/2008	Song et al.	
D584,274 S *	1/2009	Kim et al.	D14/138 AD
D597,082 S	7/2009	Bang et al.	
D602,915 S	10/2009	Song et al.	
D602,916 S	10/2009	Won et al.	
D609,221 S	2/2010	Kim et al.	
D609,222 S	2/2010	Shin	
D615,952 S *	5/2010	Kim et al.	D14/138 AA
D616,871 S *	6/2010	Enervold et al.	D14/218
D618,666 S	6/2010	Shin	
D621,372 S *	8/2010	Won et al.	D13/168
D625,276 S *	10/2010	Won et al.	D13/168
D627,343 S *	11/2010	Andre et al.	D14/341

(Continued)

OTHER PUBLICATIONS

U.S. Appl. No. 29/349,413, Applicant: Kyoung-Hoon Kim, et al.,
entitled Remote Controller for Television Receiver.

(Continued)

Primary Examiner — Celia Murphy

Assistant Examiner — John Windmuller

(74) *Attorney, Agent, or Firm* — Flynn, Thiel, Boutell &
Tanis, P.C.

(57) **CLAIM**

The ornamental design for a remote controller for TV
receiver, as shown and described.

DESCRIPTION

FIG. 1 is a top front perspective view of a remote controller
for TV receiver showing our new design;
FIG. 2 is a front elevational view thereof;
FIG. 3 is a rear elevational view thereof;
FIG. 4 is a left side elevational view thereof;
FIG. 5 is a right side elevational view thereof;
FIG. 6 is a top plan view thereof; and,
FIG. 7 is a bottom plan view thereof.

1 Claim, 4 Drawing Sheets

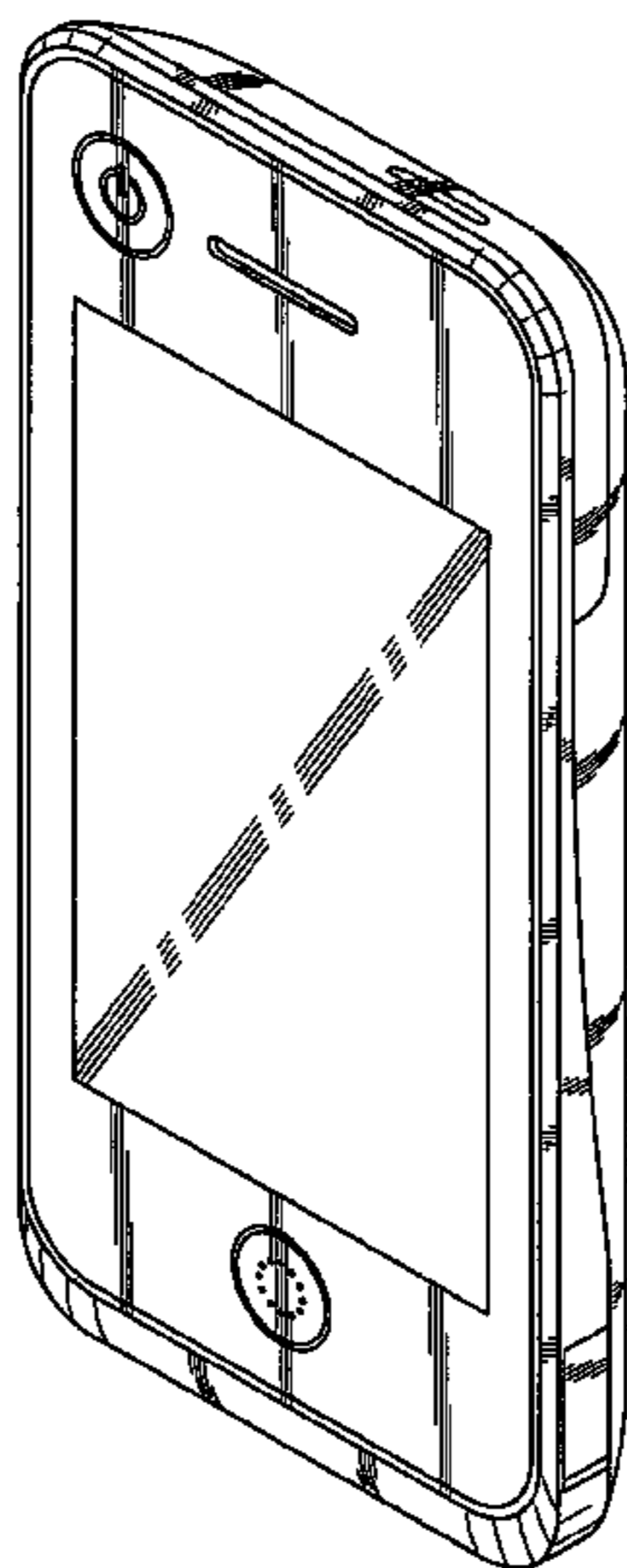

US D647,882 S

Page 2

U.S. PATENT DOCUMENTS

D629,799 S * 12/2010 Andre et al. D14/341
D632,264 S 2/2011 Choi et al.
D632,265 S 2/2011 Choi et al.
D633,090 S * 2/2011 Andre et al. D14/341
D634,715 S 3/2011 Choi et al.
D634,734 S * 3/2011 Cho D14/218
D636,353 S 4/2011 Choi et al.

D636,751 S * 4/2011 Lee et al. D14/138 AD
2010/0017736 A1 * 1/2010 Kim 715/771
2010/0159998 A1 * 6/2010 Luke et al. 455/567

OTHER PUBLICATIONS

U.S. Appl. No. 29/373,297, Applicant: Jae-Hyung Kim, et al.,
entitled Remote Controller for TV Receiver.

* cited by examiner

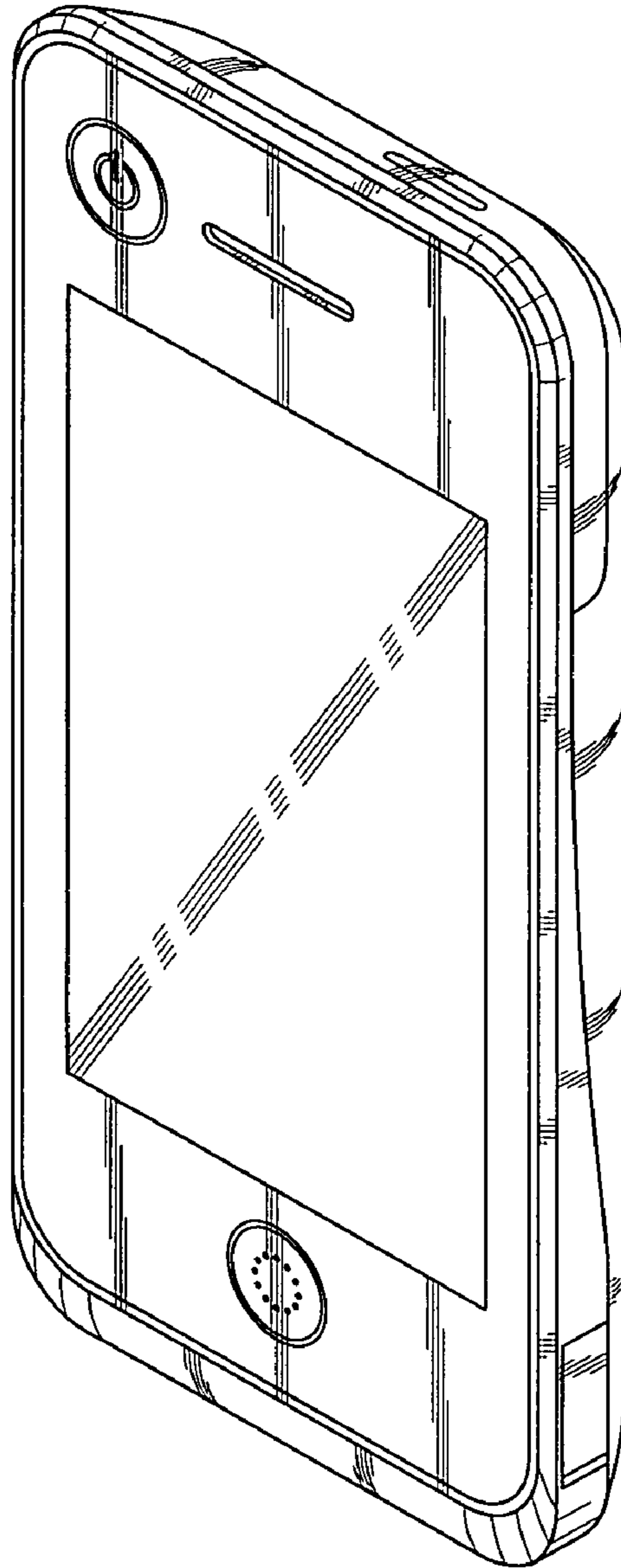

FIG. 1

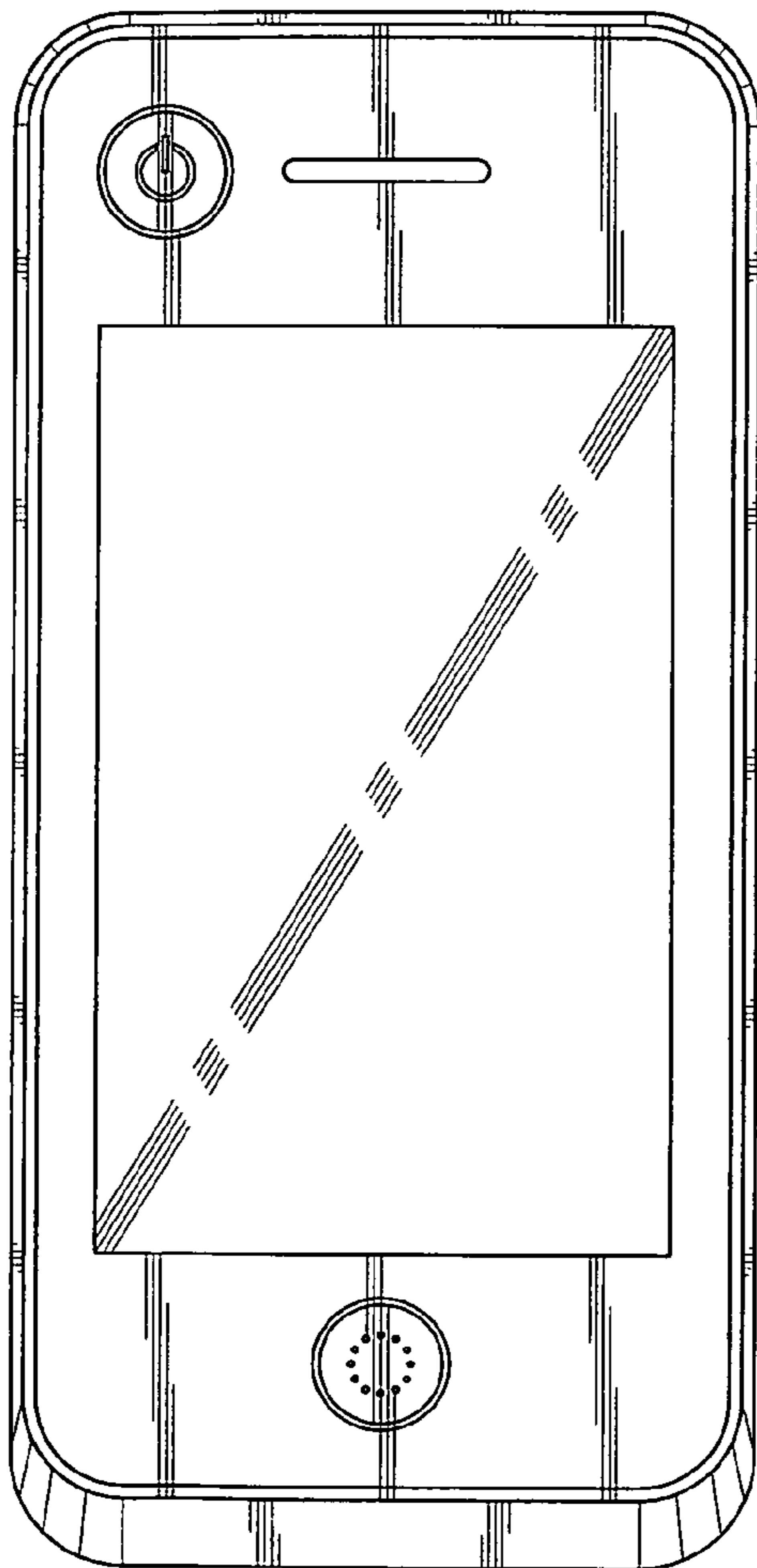

FIG. 2

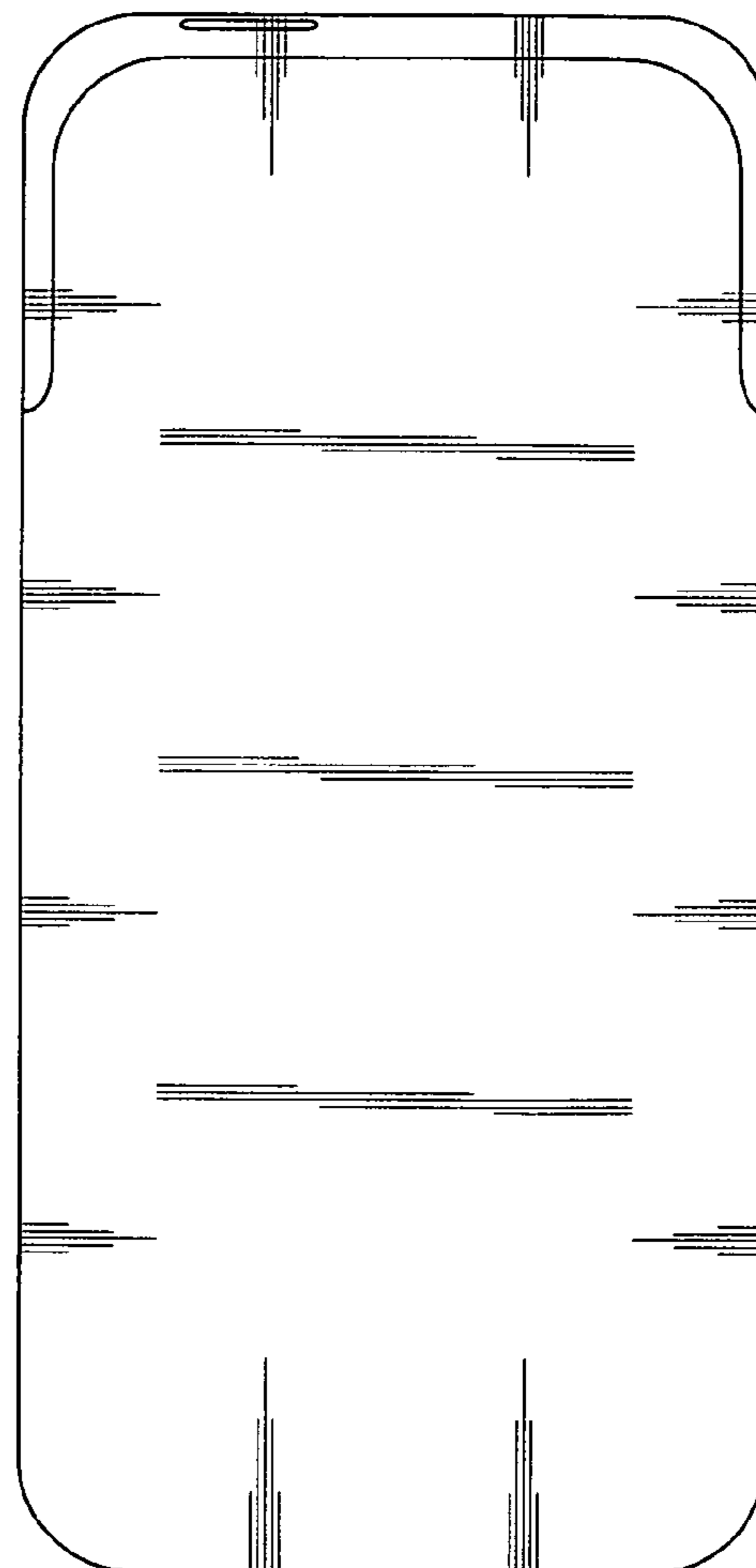

FIG. 3

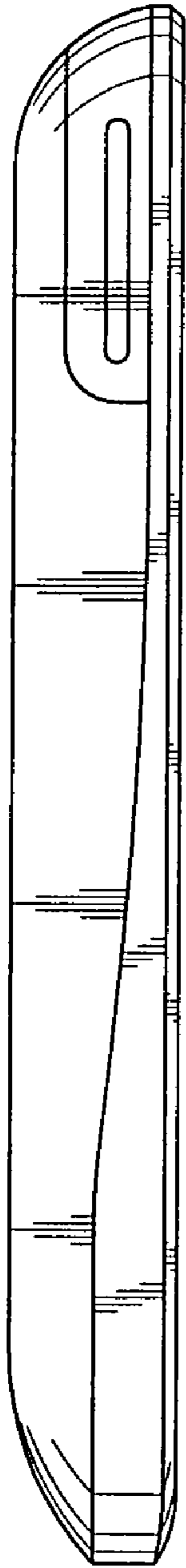

FIG. 4

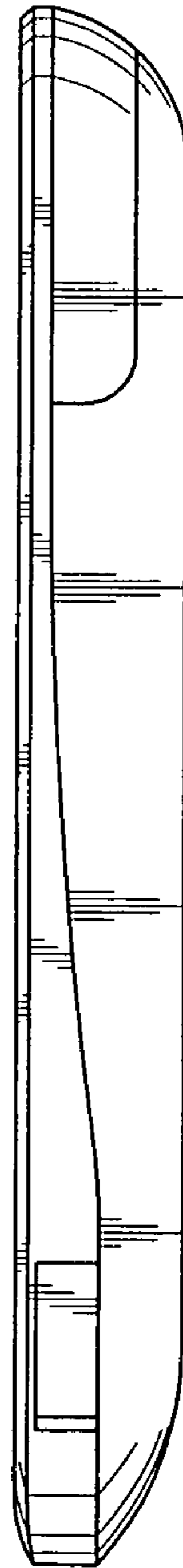

FIG. 5

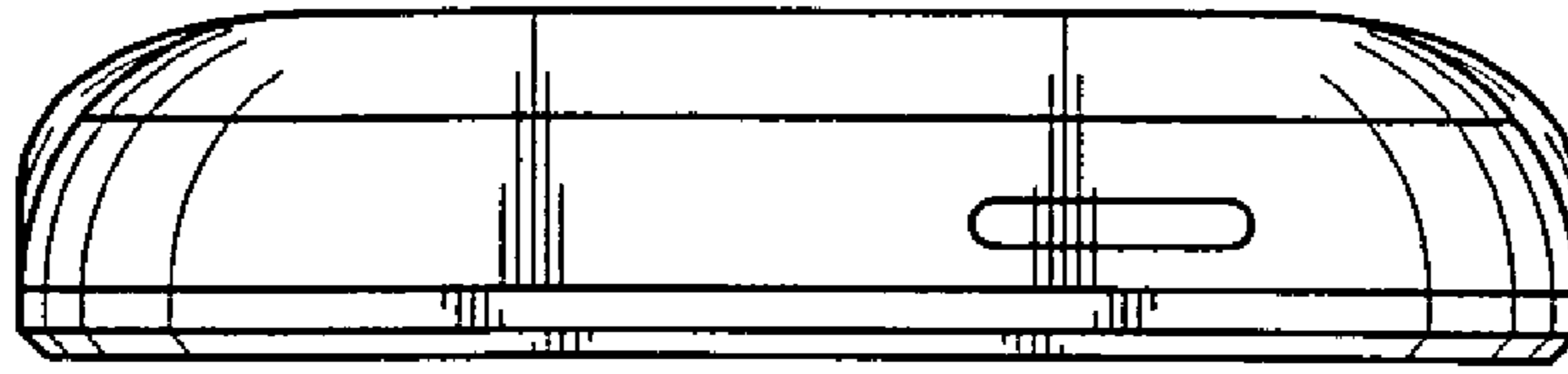

FIG. 6

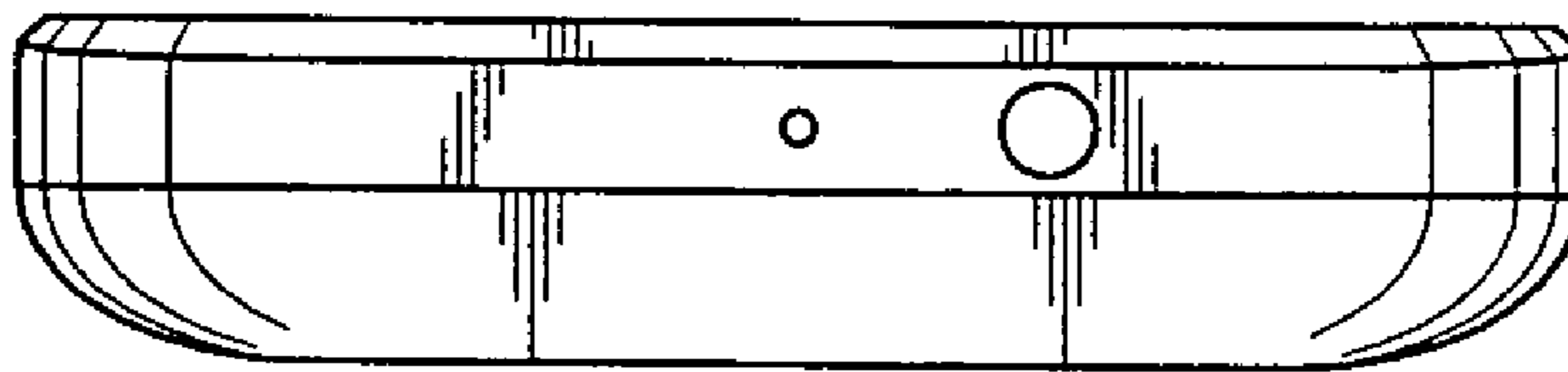

FIG. 7