



US00D647873S

(12) **United States Design Patent**
Park

(10) **Patent No.:** **US D647,873 S**

(45) **Date of Patent:** **** Nov. 1, 2011**

(54) **CELLULAR PHONE**

(75) Inventor: **Jaewoon Park**, Seoul (KR)

(73) Assignee: **LG Electronics Inc.**, Seoul (KR)

(**) Term: **14 Years**

(21) Appl. No.: **29/396,154**

(22) Filed: **Jun. 27, 2011**

(30) **Foreign Application Priority Data**

Jan. 18, 2011 (KR) 30-2011-0002166

(51) **LOC (9) Cl.** **14-03**

(52) **U.S. Cl.** **D14/138 AB**

(58) **Field of Classification Search** D14/138 AB,
D14/138 AA, 496, 341, 345, 346, 203.3,
D14/203.4, 203.7, 138 AD, 138 R, 147, 218,
D14/137; 455/575.1, 556.2, 575.3, 575.4;
D21/517; 379/433.01, 433.04, 433.11, 433.12,
379/433.13

See application file for complete search history.

(56) **References Cited**

U.S. PATENT DOCUMENTS

D352,503 S *	11/1994	Nagele	D14/138 AB
7,269,443 B2 *	9/2007	Park et al.	455/556.2
D573,127 S *	7/2008	Choi et al.	D14/138 AB
D578,979 S *	10/2008	Choi et al.	D14/138 AB
D588,569 S *	3/2009	Tompkin	D14/138 AB
D593,986 S *	6/2009	Chen et al.	D14/138 AB
D605,152 S *	12/2009	Burns	D14/138 R
D618,674 S *	6/2010	Yasuda	D14/248
D624,516 S *	9/2010	Hachiya	D14/138 AB
D630,180 S *	1/2011	Kim et al.	D14/138 AB
D631,451 S *	1/2011	Kim et al.	D14/138 AB
D633,069 S *	2/2011	Ryu et al.	D14/138 AB
D635,539 S *	4/2011	Suk et al.	D14/138 AB
D635,953 S *	4/2011	Kim	D14/138 AB
2003/0092401 A1 *	5/2003	Ikeuchi	455/90
2009/0007380 A1 *	1/2009	Feng et al.	16/305
2010/0167693 A1 *	7/2010	Yamada	455/411
2011/0077062 A1 *	3/2011	Kim et al.	455/575.3

OTHER PUBLICATIONS

LG KH3900 Joypop telephone, announced Apr. 2010, [online], [site visited Aug. 10, 2011]. Available from Internet, <URL: http://www.gsmarena.com>.*

LG GD580 Lollipop telephone, announced Jan. 2010, [online], [site visited Aug. 10, 2011]. Available from Internet, <URL: http://www.gsmarena.com>.*

LG GD350 telephone, announced Mar. 2010, [online], [site visited Aug. 10, 2011]. Available from Internet, <URL: http://www.gsmarena.com>.*

Samsung A500 telephone, announced 2002, [online], [site visited Aug. 10, 2011]. Available from Internet, <URL: http://www.gsmarena.com>.*

Samsung B300 telephone, announced Jul. 2008, [online], [site visited Aug. 10, 2011]. Available from Internet, <URL: http://www.gsmarena.com>.*

(Continued)

Primary Examiner — Jeffrey D Asch

(74) *Attorney, Agent, or Firm* — Morgan, Lewis & Bockius LLP

(57) **CLAIM**

The ornamental design for a cellular phone, as shown and described.

DESCRIPTION

FIG. 1 is a top, front, perspective view of a cellular phone showing my new design;

FIG. 2 is a front view thereof;

FIG. 3 is a rear view thereof;

FIG. 4 is a left side view thereof;

FIG. 5 is a right side view thereof;

FIG. 6 is a top view thereof;

FIG. 7 is a bottom view thereof; and,

FIG. 8 is an open front view thereof.

1 Claim, 8 Drawing Sheets

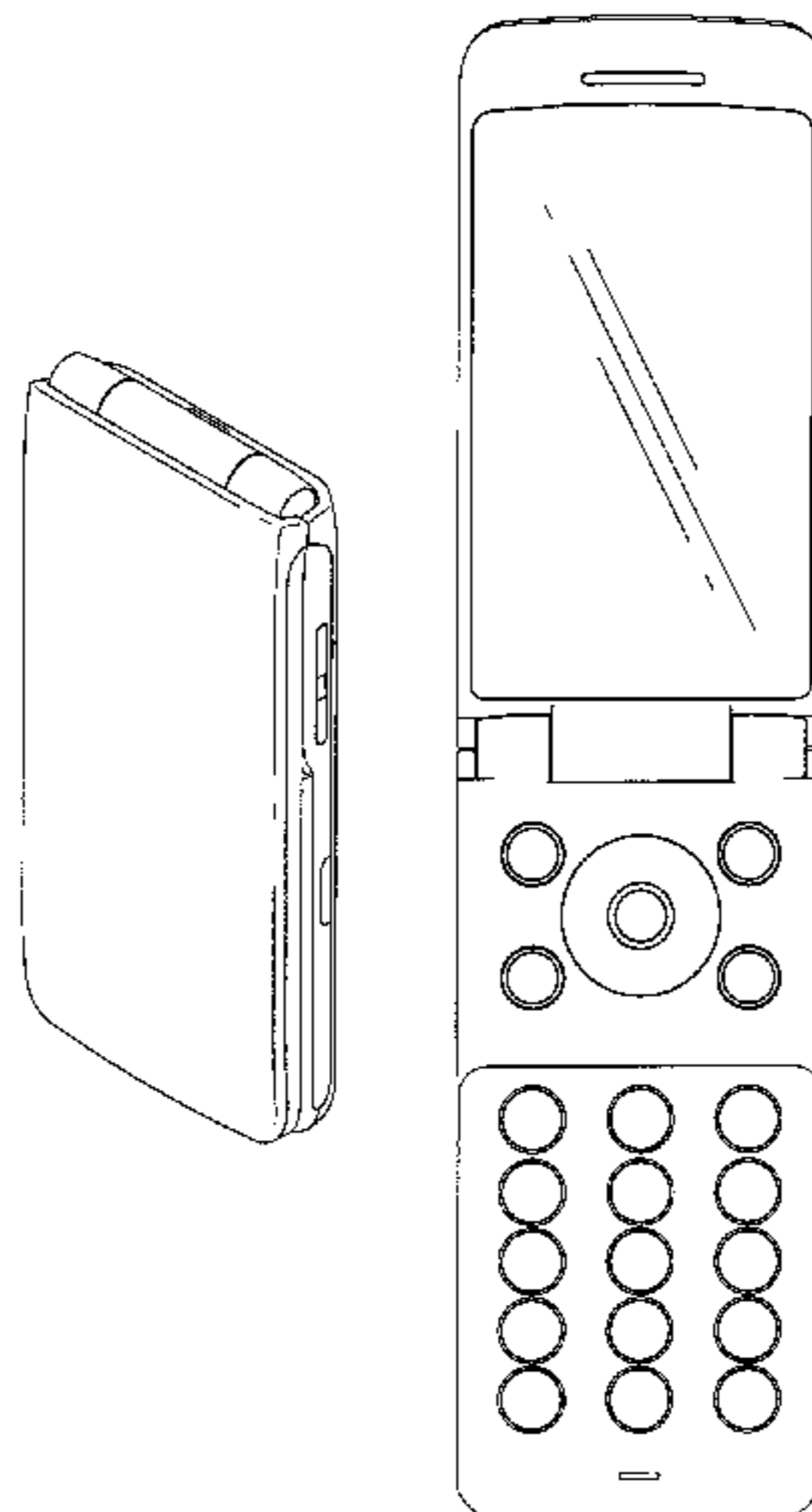

OTHER PUBLICATIONS

Samsung E2530 telephone, announced Nov. 2010, [online], [site visited Aug. 10, 2011]. Available from Internet, <URL: <http://www.gsmarena.com>>.*

Nokia 2720 fold telephone, announced May 2009, [online], [site visited Aug. 10, 2011]. Available from Internet, <URL: <http://www.gsmarena.com>>.*

Philips Xenium X530 telephone, announced Mar. 2009, [online], [site visited Aug. 10, 2011]. Available from Internet, <URL: <http://www.gsmarena.com>>.*

Sharp 936SH telephone, announced Sep. 2009, [online], [site visited Aug. 10, 2011]. Available from Internet, <URL: <http://www.gsmarena.com>>.*

* cited by examiner

FIG. 1

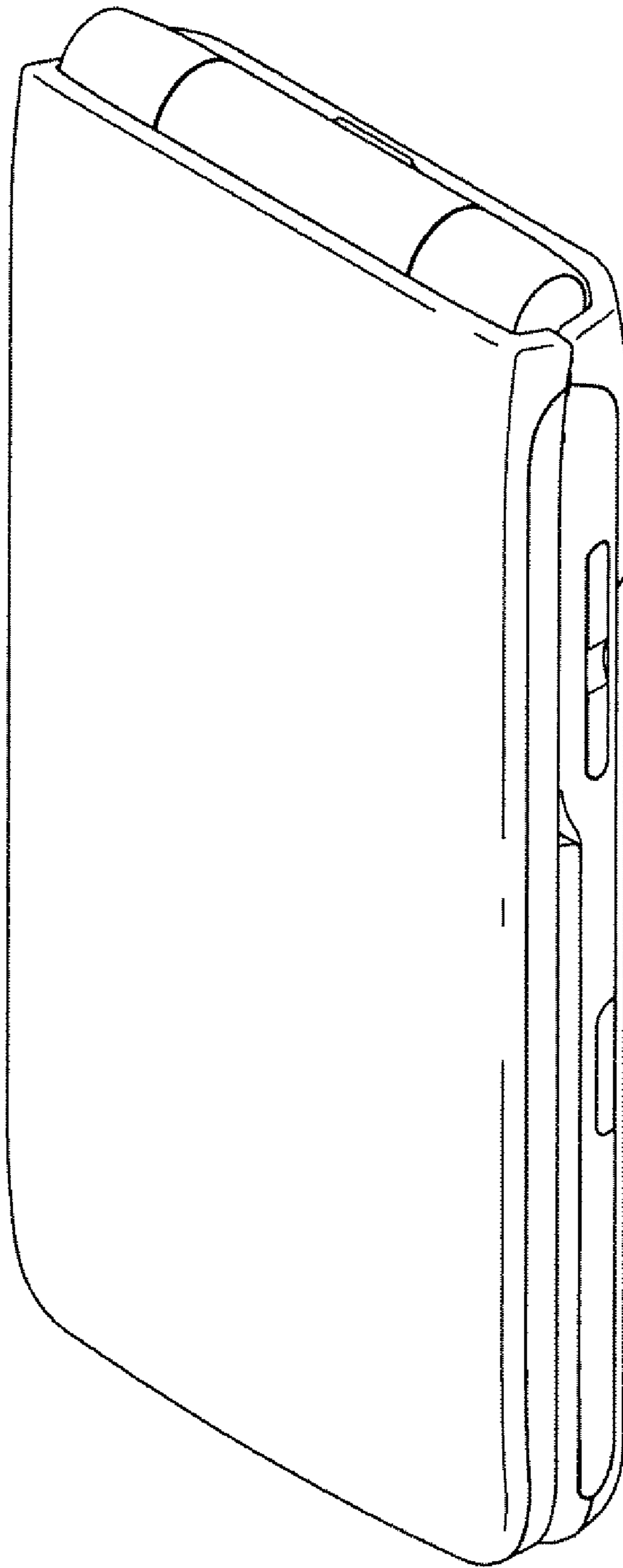

FIG. 2

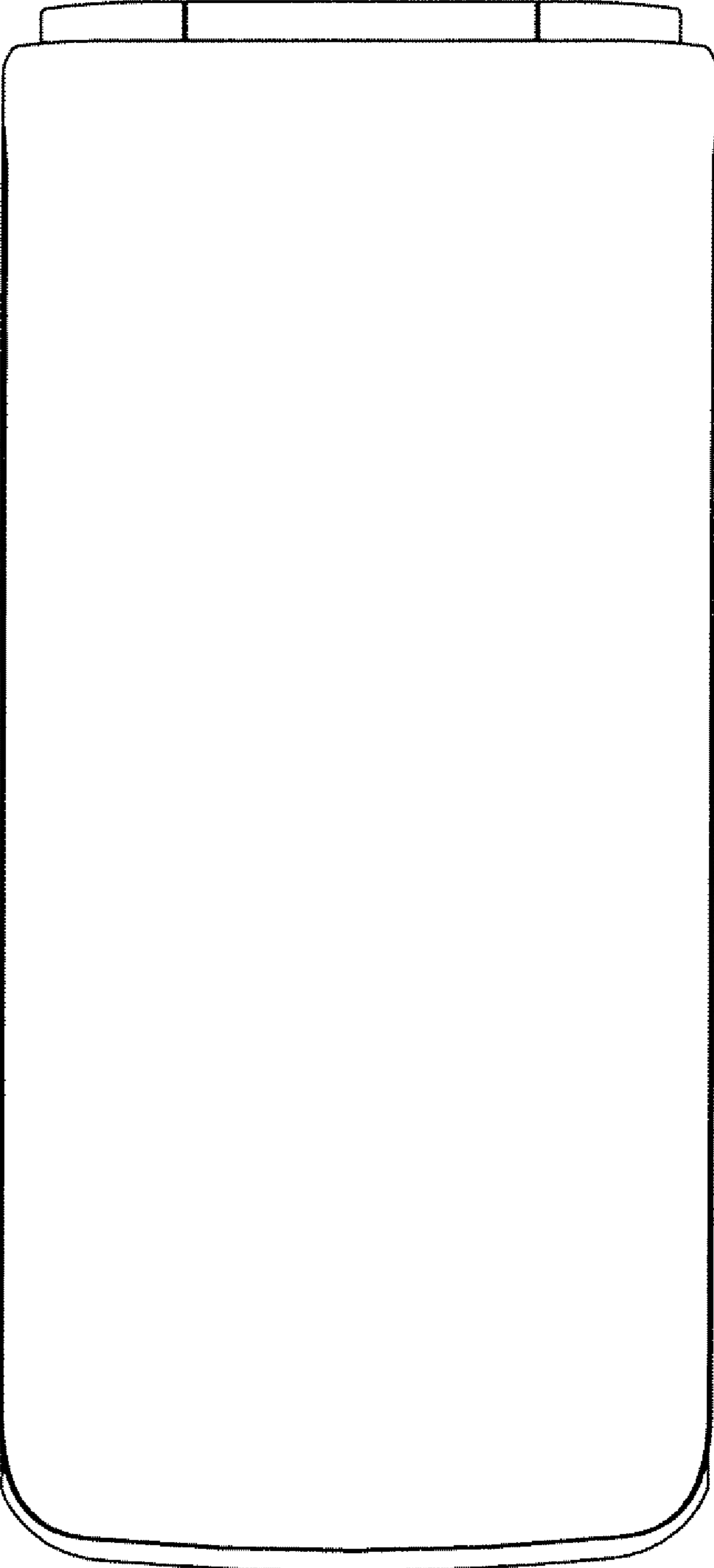

FIG. 3

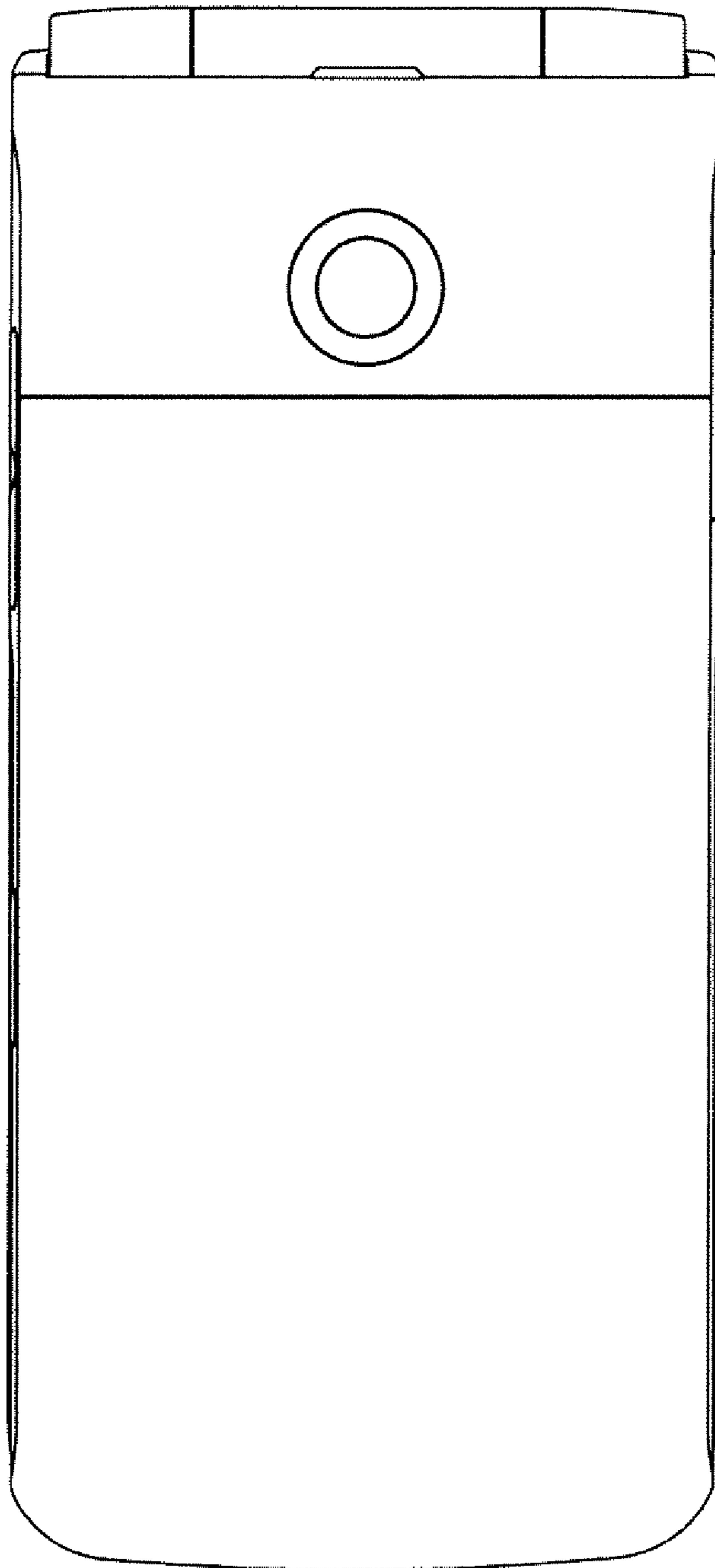

FIG. 4

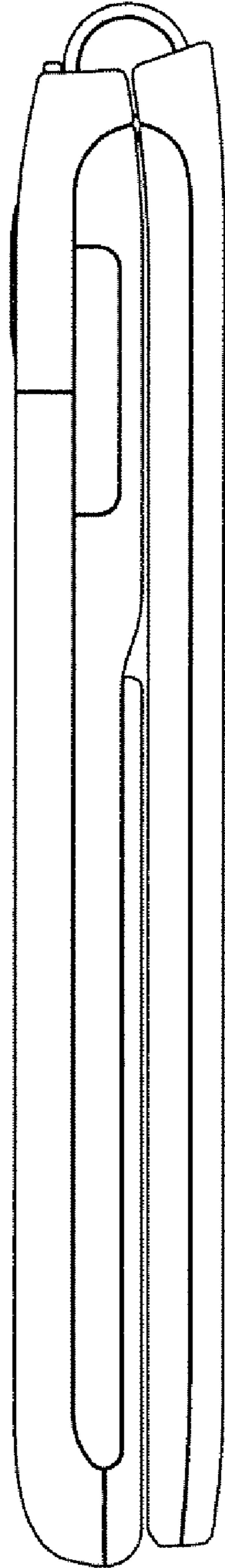

FIG. 5

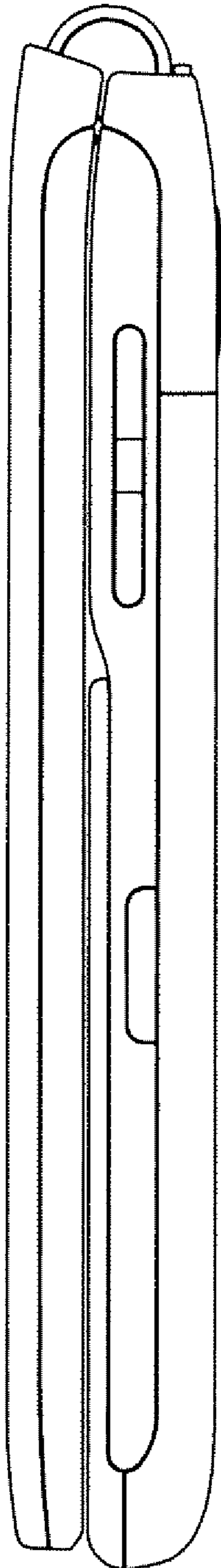

FIG. 6

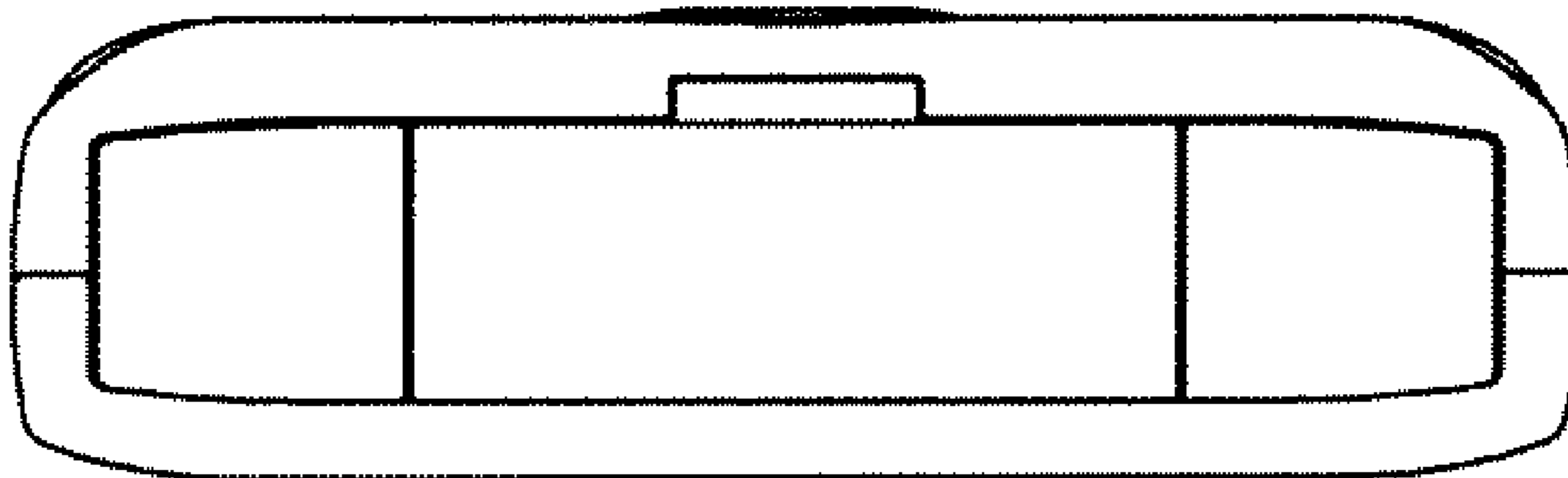

FIG. 7

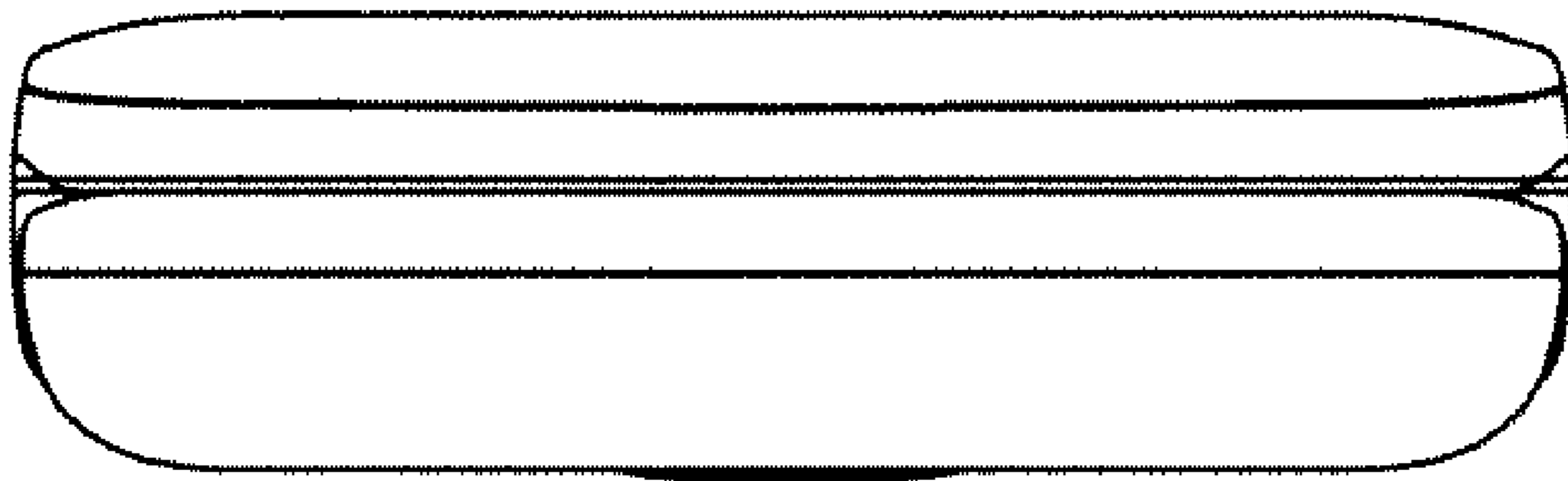

FIG. 8

