

US00D647870S

(12) **United States Design Patent**  
**Lee**

(10) **Patent No.:** **US D647,870 S**  
(45) **Date of Patent:** **\*\* Nov. 1, 2011**

(54) **PORTABLE TELEPHONE**

(75) Inventor: **Da-Hyun Lee**, Seoul (KR)

(73) Assignee: **Samsung Electronics Co., Ltd.**, Suwon (KR)

(\*\*) Term: **14 Years**

(21) Appl. No.: **29/390,406**

(22) Filed: **Apr. 25, 2011**

(30) **Foreign Application Priority Data**

Dec. 28, 2010 (KR) ..... 30-2010-0056186

(51) **LOC (9) Cl.** ..... **14-03**

(52) **U.S. Cl.** ..... **D14/138 AA**

(58) **Field of Classification Search** ..... D14/138 AA,  
D14/496, 341, 345, 346, 203.3, 203.4, 203.7,  
D14/138 AB, 138 AD, 138 R, 147, 218, 137;  
455/575.1, 556.2, 575.3, 575.4; D21/517;  
379/433.01, 433.04, 433.11, 433.12, 433.13  
See application file for complete search history.

(56) **References Cited**

**U.S. PATENT DOCUMENTS**

D307,888 S	5/1990	Ishida
D337,569 S	7/1993	Kando
D498,735 S	11/2004	Chen et al.
D503,164 S	3/2005	Park et al.
D515,536 S	2/2006	Lee et al.
D515,537 S	2/2006	Kim et al.
D517,038 S	3/2006	Lee et al.
D517,039 S	3/2006	Lee
7,016,182 B2	3/2006	Brandenberg et al.
D524,276 S	7/2006	Kim et al.
D525,228 S	7/2006	Kim et al.
D525,609 S	7/2006	Kim et al.
D525,959 S	8/2006	Kim et al.
D526,636 S	8/2006	Kim et al.
D528,528 S	9/2006	Moon et al.

D529,472 S	10/2006	Kim et al.
D529,474 S	10/2006	Park et al.
D529,887 S	10/2006	Chung et al.
D530,295 S	10/2006	Chung et al.
D534,143 S	12/2006	Lheem
D534,888 S	1/2007	Kim et al.
D535,275 S	1/2007	Kim et al.
D536,326 S	2/2007	Kim et al.
D536,690 S	2/2007	Lee

(Continued)

**FOREIGN PATENT DOCUMENTS**

KR 3004595990000 8/2007

(Continued)

**OTHER PUBLICATIONS**

Samsung Ch@t 335 telephone, announced Nov. 2010, [online], [site visited Aug. 23, 2011]. Available from Internet, <URL: <http://www.gsmarena.com>>.\*

(Continued)

*Primary Examiner* — Jeffrey D Asch  
(74) *Attorney, Agent, or Firm* — Wood, Herron & Evans, LLP

(57) **CLAIM**

The ornamental design for a portable telephone, as shown and described.

**DESCRIPTION**

FIG. 1 is a top front perspective view of a portable telephone showing my new design;  
FIG. 2 is a front elevational view thereof;  
FIG. 3 is a rear elevational view thereof;  
FIG. 4 is a left side elevational view thereof;  
FIG. 5 is a right side elevational view thereof;  
FIG. 6 is a top plan view thereof; and,  
FIG. 7 is a bottom plan view thereof.

**1 Claim, 3 Drawing Sheets**

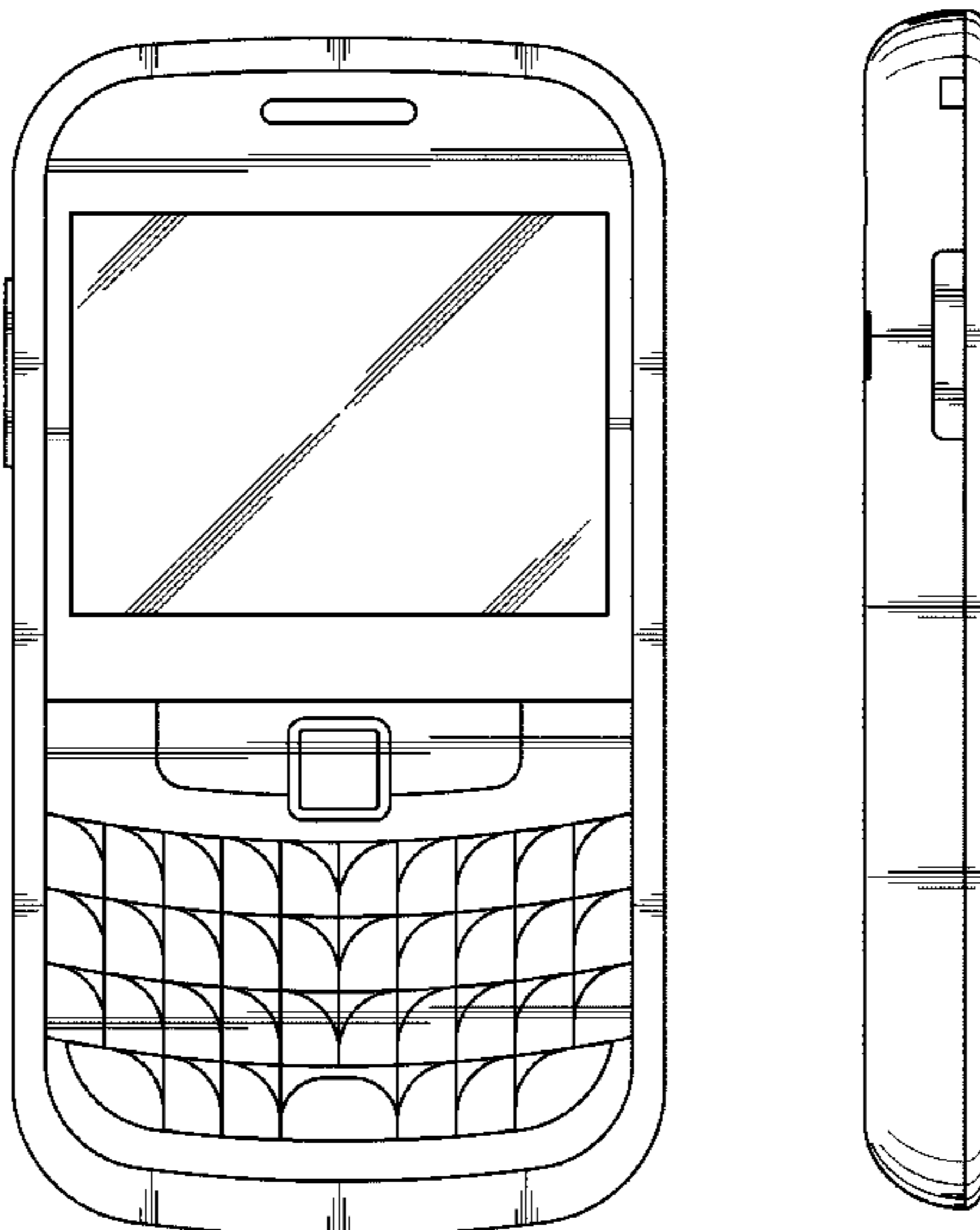

# US D647,870 S

Page 2

U.S. PATENT DOCUMENTS					
D537,432 S	2/2007	Kim et al.	D567,208 S	4/2008	Suk et al.
D538,250 S	3/2007	Choi et al.	D567,794 S	4/2008	Kim et al.
D538,251 S	3/2007	Park et al.	D567,797 S	4/2008	Suk et al.
D539,253 S	3/2007	Park et al.	D568,854 S	5/2008	Park et al.
D539,254 S	3/2007	Park et al.	D568,861 S	5/2008	Kim et al.
D542,258 S	5/2007	Park et al.	D569,833 S	5/2008	Suk et al.
D542,259 S	5/2007	Cho et al.	D569,834 S	5/2008	Suk et al.
D543,178 S	5/2007	Kim et al.	D569,835 S	5/2008	Han et al.
D543,184 S	5/2007	Moon et al.	D569,836 S	5/2008	Han et al.
D543,188 S	5/2007	Minamide et al.	D570,320 S	6/2008	Lee et al.
D545,804 S	7/2007	Lee	D570,321 S	6/2008	Choi et al.
D546,795 S	7/2007	Kim et al.	D570,323 S	6/2008	Okada et al.
D546,804 S	7/2007	Lee et al.	D570,346 S	6/2008	Suk et al.
D547,743 S	7/2007	Kim et al.	D570,815 S	6/2008	Son et al.
D547,744 S	7/2007	Kim et al.	D570,816 S	6/2008	Lee et al.
D548,214 S	8/2007	Kim et al.	D570,838 S	6/2008	Suk et al.
D548,713 S	8/2007	Lee et al.	D571,341 S	6/2008	Chung et al.
D548,714 S	8/2007	Kim et al.	D571,762 S	6/2008	Lee et al.
D550,187 S	9/2007	Lee et al.	D572,229 S	7/2008	Kim et al.
D551,201 S	9/2007	Kim et al.	D572,697 S	7/2008	Lee et al.
D551,647 S	9/2007	Kim et al.	D572,699 S	7/2008	Ahn et al.
D552,069 S	10/2007	Lee et al.	D572,700 S	7/2008	Kwon et al.
D552,583 S	10/2007	Choi et al.	D573,129 S	7/2008	Park et al.
D553,112 S	10/2007	Kim et al.	D573,130 S	7/2008	Kim et al.
D553,113 S	10/2007	Cha et al.	D573,570 S	7/2008	Park et al.
D553,115 S	10/2007	Suk et al.	D573,571 S	7/2008	Morrison et al.
D554,097 S	10/2007	Lee	D573,573 S	7/2008	Jung et al.
D555,137 S	11/2007	Kim et al.	D573,576 S	7/2008	Kim et al.
D555,140 S	11/2007	Kim et al.	D573,965 S	7/2008	Choi et al.
D556,165 S	11/2007	Kim et al.	D574,353 S	8/2008	Park et al.
D556,724 S	12/2007	Choi et al.	D575,759 S	8/2008	Park et al.
D556,727 S	12/2007	Cha et al.	D575,760 S	8/2008	Kim et al.
D557,242 S	12/2007	Kim et al.	D576,140 S	9/2008	Park et al.
D557,245 S	12/2007	Kim et al.	D576,141 S	9/2008	Moon et al.
D557,246 S	12/2007	Kim et al.	D576,143 S	9/2008	Jeoung et al.
D558,175 S	12/2007	Choi et al.	D576,144 S	9/2008	Han et al.
D558,176 S	12/2007	Lee et al.	D576,595 S	9/2008	Han et al.
D558,713 S	1/2008	Kim et al.	D576,596 S	9/2008	Moon et al.
D558,720 S	1/2008	Lee et al.	D576,986 S	9/2008	Kim et al.
D559,219 S	1/2008	Suk et al.	D576,990 S	9/2008	Han et al.
D559,223 S	1/2008	Kim et al.	D576,992 S	9/2008	Kim et al.
D559,224 S	1/2008	Moon et al.	D576,993 S	9/2008	Park et al.
D559,826 S	1/2008	Lee	D576,994 S	9/2008	Oh et al.
D560,188 S	1/2008	Lee et al.	D577,349 S	9/2008	Choi et al.
D560,191 S	1/2008	Choi et al.	D577,351 S	9/2008	Kim et al.
D560,195 S	1/2008	Moon et al.	D577,704 S	9/2008	Park et al.
D560,197 S	1/2008	Kim et al.	D578,095 S	10/2008	Chung et al.
D560,199 S	1/2008	Lee et al.	D578,101 S	10/2008	Park et al.
D560,635 S	1/2008	Kim et al.	D578,502 S	10/2008	Kim et al.
D560,642 S	1/2008	Yun et al.	D578,503 S	10/2008	Shin et al.
D560,644 S	1/2008	Choi et al.	D578,985 S	10/2008	Kim et al.
D560,647 S	1/2008	Choi et al.	D578,989 S	10/2008	Kim et al.
D561,153 S	2/2008	Hong et al.	D579,898 S	11/2008	Lee et al.
D561,154 S	2/2008	Kim et al.	D579,902 S	11/2008	Kim et al.
D561,156 S	2/2008	Jung et al.	D580,394 S	11/2008	Kim et al.
D561,512 S	2/2008	Park et al.	D580,395 S	11/2008	Oh et al.
D561,720 S	2/2008	Suk et al.	D580,403 S	11/2008	Jung et al.
D561,727 S	2/2008	Suk et al.	D580,904 S	11/2008	Park et al.
D562,283 S	2/2008	Moon et al.	D581,384 S	11/2008	Kim et al.
D562,291 S	2/2008	Bang et al.	D581,892 S	12/2008	Lee et al.
D562,293 S	2/2008	Bang et al.	D581,893 S	12/2008	Kim et al.
D562,294 S	2/2008	Bang et al.	D582,369 S	12/2008	Jeoung et al.
D562,794 S	2/2008	Kim et al.	D582,380 S	12/2008	Kim et al.
D563,363 S	3/2008	Park et al.	D582,884 S	12/2008	Lee et al.
D563,370 S	3/2008	Choi et al.	D583,348 S	12/2008	Lee et al.
D563,373 S	3/2008	Suk et al.	D583,350 S	12/2008	Park et al.
D563,931 S	3/2008	Moon et al.	D584,262 S *	1/2009	Hu et al. .... D14/138 AA
D563,934 S	3/2008	Jung et al.	D584,266 S	1/2009	Kim et al.
D563,937 S	3/2008	Lee et al.	D585,414 S	1/2009	Kim et al.
D564,490 S	3/2008	Kim et al.	7,480,524 B2	1/2009	Moon et al.
D564,491 S	3/2008	Kim et al.	D589,924 S	4/2009	Jung et al.
D565,011 S	3/2008	Lee et al.	D591,252 S	4/2009	Kim et al.
D565,015 S	3/2008	Kim et al.	D591,742 S *	5/2009	Hofer et al. .... D14/346
D565,016 S	3/2008	Kwon et al.	D592,628 S	5/2009	Kim et al.
D565,017 S	3/2008	Kim et al.	D593,059 S	5/2009	Kim et al.
D565,533 S	4/2008	Kim et al.	D594,840 S	6/2009	Kim et al.
D566,086 S	4/2008	Hong et al.	D599,794 S *	9/2009	Ferrari et al. .... D14/346
D566,094 S	4/2008	Kim et al.	D601,540 S *	10/2009	Kim et al. .... D14/138 AA
			D606,540 S *	12/2009	Liao et al. .... D14/346

D607,866	S	*	1/2010	Kim et al. ....	D14/138 AA
D607,868	S	*	1/2010	Kim et al. ....	D14/138 AA
D608,329	S	*	1/2010	Kim et al. ....	D14/138 AA
D614,159	S	*	4/2010	Lee et al. ....	D14/138 AA
D615,061	S	*	5/2010	Choi et al. ....	D14/138 AA
D615,062	S	*	5/2010	Tsai et al. ....	D14/138 AA
D615,953	S	*	5/2010	Lee et al. ....	D14/138 AA
D620,468	S	*	7/2010	Kim et al. ....	D14/138 AA
D622,247	S	*	8/2010	Kwon et al. ....	D14/138 AA
D623,163	S	*	9/2010	Choi et al. ....	D14/138 AA
D624,537	S	*	9/2010	Wood et al. ....	D14/346
D626,105	S	*	10/2010	Kim et al. ....	D14/138 AA
D628,550	S	*	12/2010	Chen .....	D14/138 AA
D637,575	S	*	5/2011	McConnell et al. ..	D14/138 AA
D642,153	S	*	7/2011	Nilsen et al. ....	D14/138 AA
D643,395	S	*	8/2011	Moss .....	D14/138 AA
2003/0125094	A1		7/2003	Hyun et al.	
2004/0229664	A1		11/2004	Chadha	
2005/0096082	A1		5/2005	Chang	
2007/0287504	A1		12/2007	Lim et al.	
2008/0039157	A1		2/2008	Park	
2008/0265264	A1		10/2008	Ichinose et al.	
2009/0011806	A1*		1/2009	Man et al. ....	455/575.7
2009/0111508	A1		4/2009	Yeh et al.	
2011/0183729	A1*		7/2011	Satou .....	455/575.1

FOREIGN PATENT DOCUMENTS

KR	300459600000	8/2007
KR	3005846650000	1/2011
KR	3005865830000	1/2011
KR	3005865840000	1/2011
KR	3005607680001	7/2011
KR	3006034040000	7/2011
KR	3006047090000	7/2011
KR	3006063230000	7/2011
KR	3006063480000	7/2011
KR	3006063570000	7/2011
KR	3006063970000	7/2011
KR	3006064070000	7/2011

OTHER PUBLICATIONS

Nokia E5 telephone, announced Apr. 2010, [online], [site visited Aug. 23, 2011]. Available from Internet, <URL: <http://www.gsmarena.com>>.\*

Samsung Ch@t 322 telephone, announced Oct. 2010, [online], [site visited Aug. 23, 2011]. Available from Internet, <URL: <http://www.gsmarena.com>>.\*

Samsung Ch@t 222 telephone, announced May 2011, [online], [site visited Aug. 23, 2011]. Available from Internet, <URL: <http://www.gsmarena.com>>.\*

Motorola Motokey Mini EX108 telephone, announced Jun. 2011, [online], [site visited Aug. 23, 2011]. Available from Internet, <URL: <http://www.gsmarena.com>>.\*

BLU Speed telephone, announced Oct. 2010, [online], [site visited Aug. 23, 2011]. Available from Internet, <URL: <http://www.gsmarena.com>>.\*

Alcatel OT-900 telephone, announced Feb. 2011, [online], [site visited Aug. 23, 2011]. Available from Internet, <URL: <http://www.gsmarena.com>>.\*

Vodafone 555 Blue telephone, announced Jul. 2011, [online], [site visited Aug. 23, 2011]. Available from Internet, <URL: <http://www.gsmarena.com>>.\*

Huawei G6150 telephone, announced Sep. 2010, [online], [site visited Aug. 23, 2011]. Available from Internet, <URL: <http://www.gsmarena.com>>.\*

Blackberry Bold 9000 telephone, announced May 2008, [online], [site visited Aug. 23, 2011]. Available from Internet, <URL: <http://www.gsmarena.com>>.\*

U.S. Appl. No. 29/301,735, Applicant Ji-Young Lee et al., filed Mar. 14, 2008, title Portable Telephone.

U.S. Appl. No. 29/301,745, Applicant Kwang-Ha Choi et al., filed Mar. 14, 2008, title Portable Telephone.

U.S. Appl. No. 29/301,762, Applicant Kwan-Ui Hong et al., filed Mar. 14, 2008, title Portable Telephone.

U.S. Appl. No. 29/307,986, Applicant Bum-Soo Park et al., filed May 21 2008, title Portable Telephone.

U.S. Appl. No. 29/310,998, Applicant Chang-Hoon Suk et al., filed Sep. 24, 2008, title Portable Telephone.

U.S. Appl. No. 29/312,001 Applicant Chang-Hoon Suk et al., filed Sep. 24, 2008, title Portable Telephone.

U.S. Appl. No. 29/311,000 Applicant Chang-Hoon Suk et al., filed Sep. 24, 2008, title Portable Telephone.

U.S. Appl. No. 29/312,001 Applicant Mark Sterzick, filed Nov. 19, 2008, title Portable Telephone.

U.S. Appl. No. 29/310,999, Applicant Ki-Eon Lee et al., filed Sep. 24, 2008, title Portable Telephone.

U.S. Appl. No. 29/312,004, Applicant Ki-Eon Lee et al., filed Sep. 24, 2008, title Portable Telephone.

U.S. Appl. No. 29/312,003, Applicant Bo-Ra Kim et al., filed Sep. 24, 2008, title Portable Telephone.

U.S. Appl. No. 29/312,002, Applicant Bo-Ra Kim et al., filed Sep. 24, 2008, title Portable Telephone.

U.S. Appl. No. 29/312,490, Applicant Jin-Soo Kim et al., filed Oct. 23, 2008, title Portable Telephone.

U.S. Appl. No. 29/312,491, Applicant Ki-Eon Lee et al., filed Oct. 23, 2008, title Portable Telephone.

U.S. Appl. No. 29/301,764, Applicant Jong-Bo Jung et al., filed Mar. 14, 2008, title Portable Telephone.

U.S. Appl. No. 29/307,987, Applicant Seong-Won Cha et al., filed May 21, 2008, title Portable Telephone.

U.S. Appl. No. 29/390,404, Applicant Jin-Hoo Lee, filed Apr. 25, 2011, title Portable Telephone.

U.S. Appl. No. 29/390,413, Applicant Jin-Hoo Lee, filed Apr. 25, 2011, title Portable Telephone.

Samsung i320 telephone, announced online Feb. 2006, Retrieved from Internet Jun. 16, 2007 URL:<http://gsarena.com>.

Samsung P300 telephone, announced 4th quarter 2005, [Retrieved from Internet Jun. 16, 2007] URL:<http://www.gsarena.com>.

\* cited by examiner

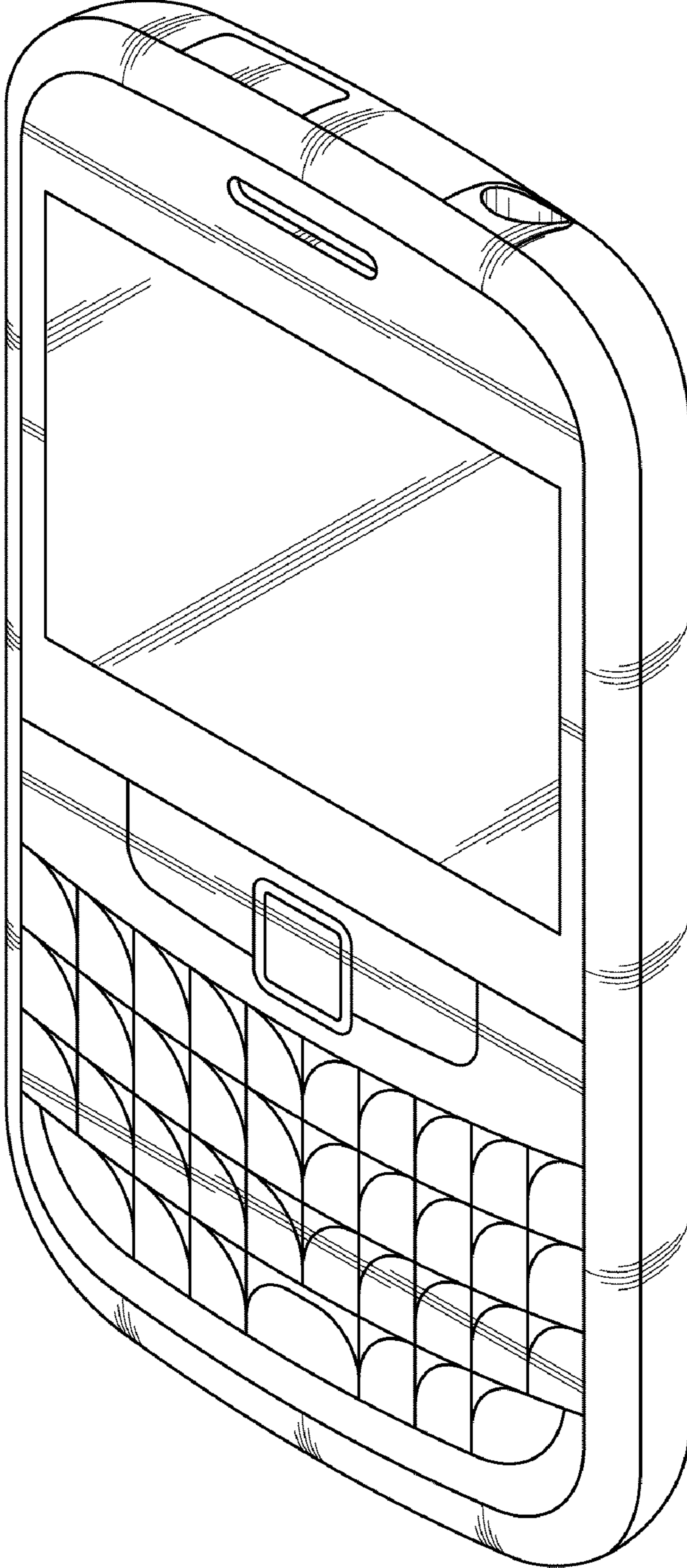

FIG.1

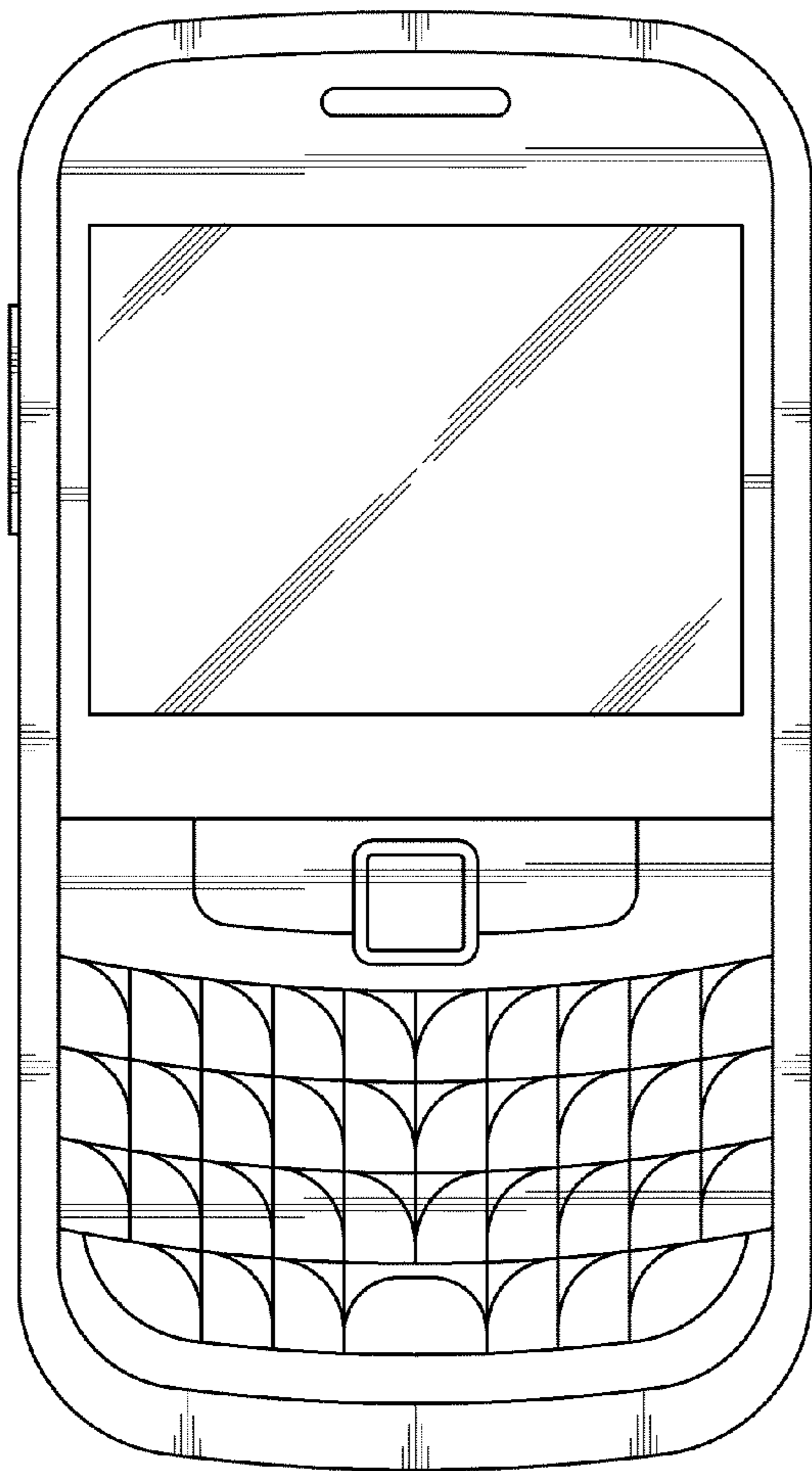

FIG.2

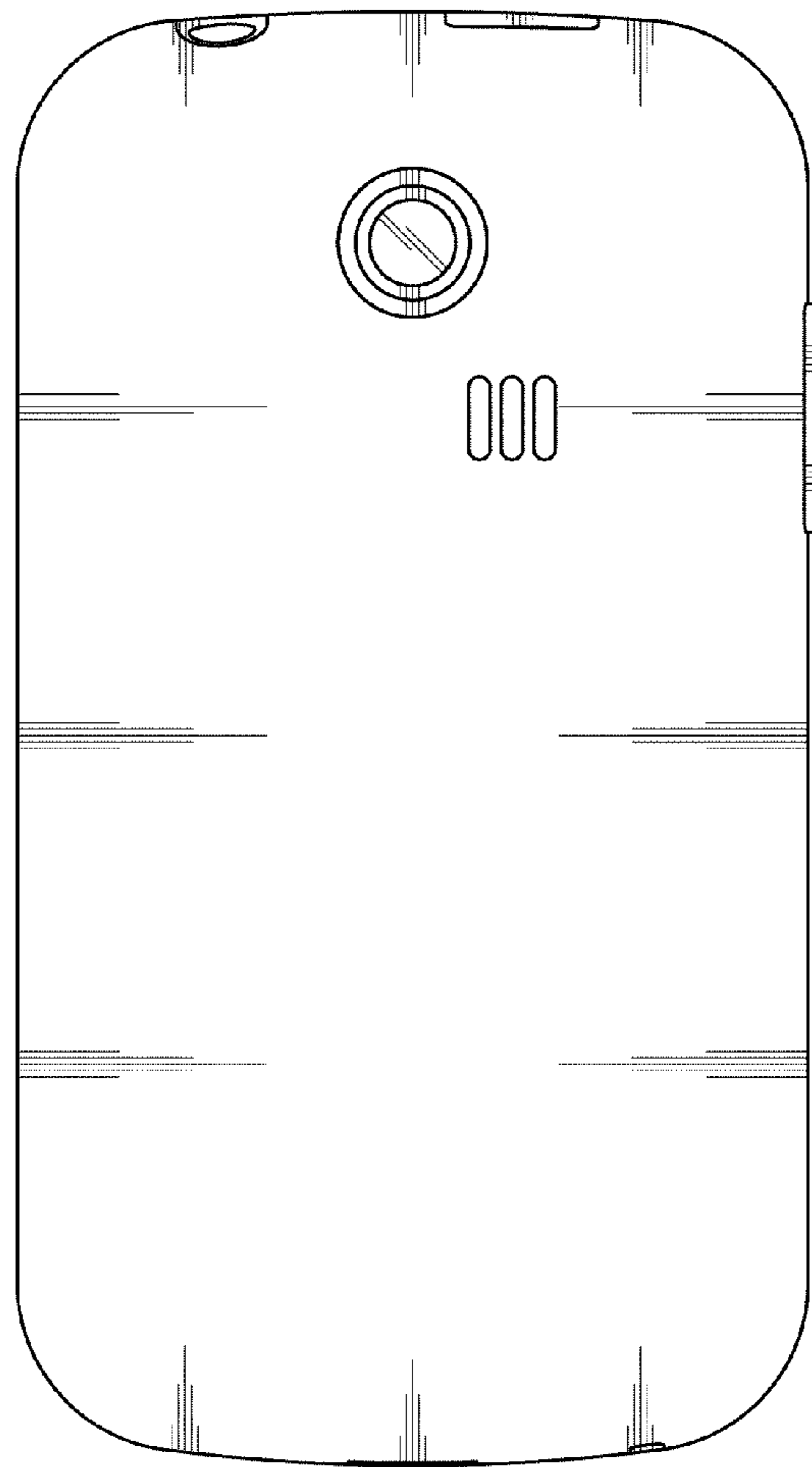

FIG.3

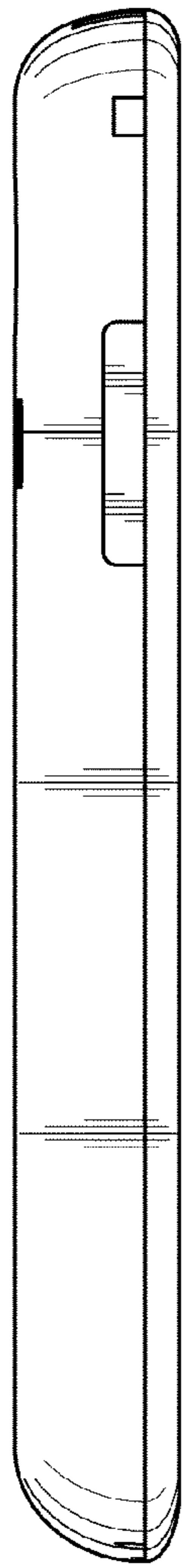

FIG.4

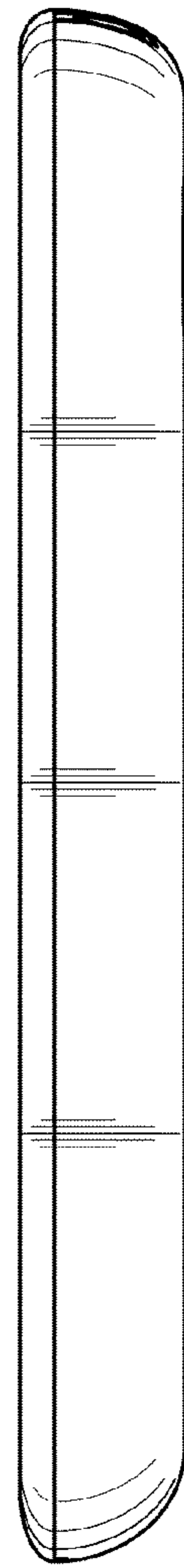

FIG.5

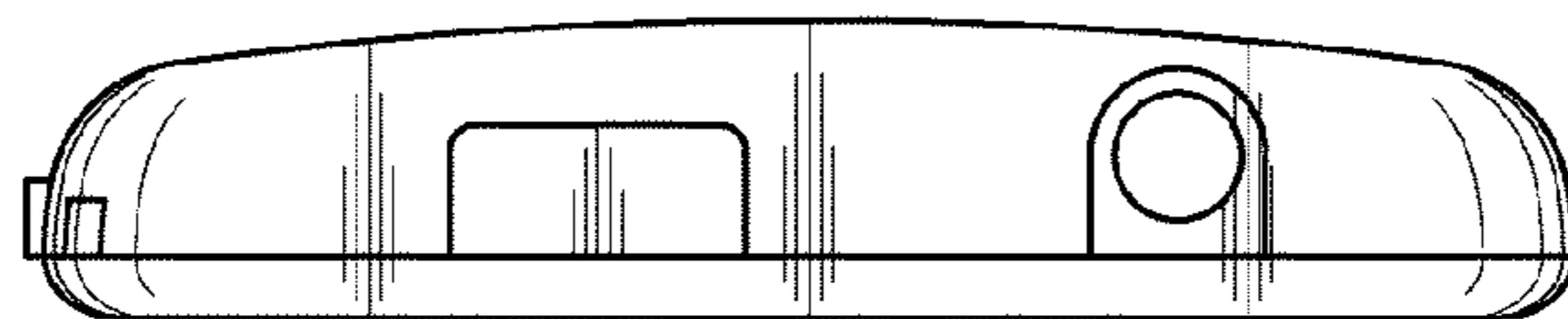

FIG.6

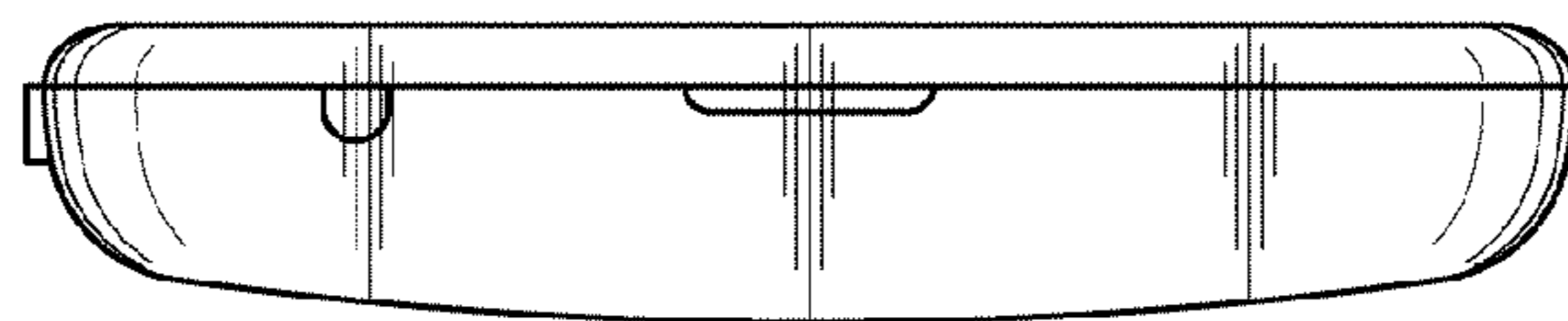

FIG.7