



US00D647815S

(12) **United States Design Patent**  
**Froehlich**

(10) **Patent No.:** **US D647,815 S**  
(45) **Date of Patent:** **\*\* Nov. 1, 2011**

(54) **STONE**

(75) Inventor: **Maik Froehlich**, Kundl (AT)

(73) Assignee: **Swarovski Aktiengesellschaft**, Triesen (LI)

(\*\*) Term: **14 Years**

(21) Appl. No.: **29/378,365**

(22) Filed: **Nov. 3, 2010**

(30) **Foreign Application Priority Data**

Jul. 19, 2010 (EM) ..... 1225502-0004

(51) **LOC (9) Cl.** ..... **11-01**

(52) **U.S. Cl.** ..... **D11/90**

(58) **Field of Classification Search** ..... D11/1-2,  
D11/26-29, 89-92; 63/26-28, 32

See application file for complete search history.

(56) **References Cited**

U.S. PATENT DOCUMENTS

D529,540 S \* 10/2006 Nakamura ..... D18/34.9  
D592,540 S \* 5/2009 Rydlewicz ..... D11/90  
D608,684 S \* 1/2010 Swarovski ..... D11/90

\* cited by examiner

*Primary Examiner* — Ralf Seifert

(74) *Attorney, Agent, or Firm* — Wenderoth, Lind & Ponack, L.L.P.

(57) **CLAIM**

The ornamental design for an ornamental stone, as shown and described.

**DESCRIPTION**

FIG. 1 is a front view of the invention;  
FIG. 2 is a rear view of the invention;  
FIG. 3 is a left side view of the invention;  
FIG. 4 is a right side view of the invention;  
FIG. 5 is a top view of the invention;  
FIG. 6 is a bottom view of the invention; and,  
FIG. 7 is a perspective view of the invention.

**1 Claim, 7 Drawing Sheets**

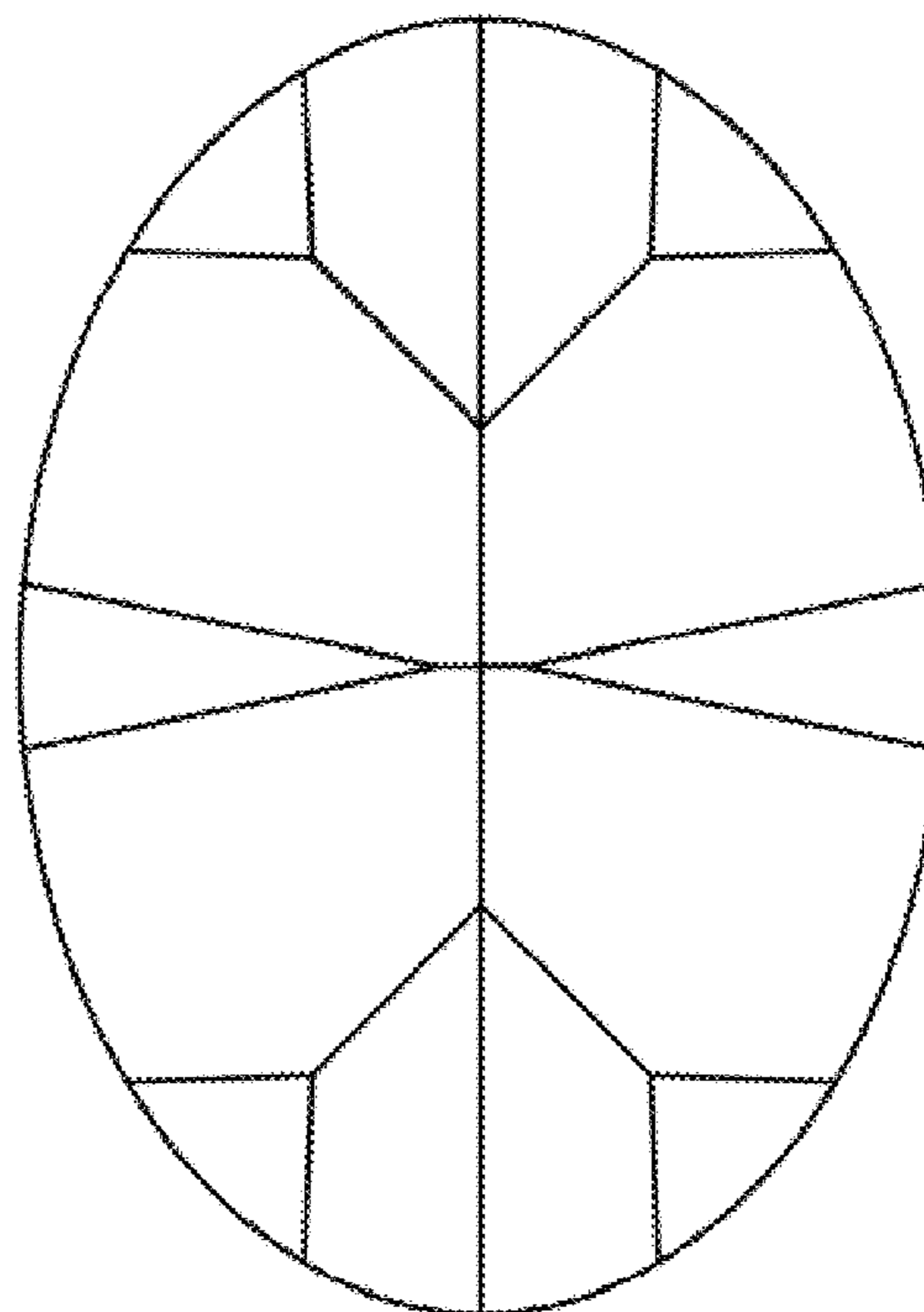
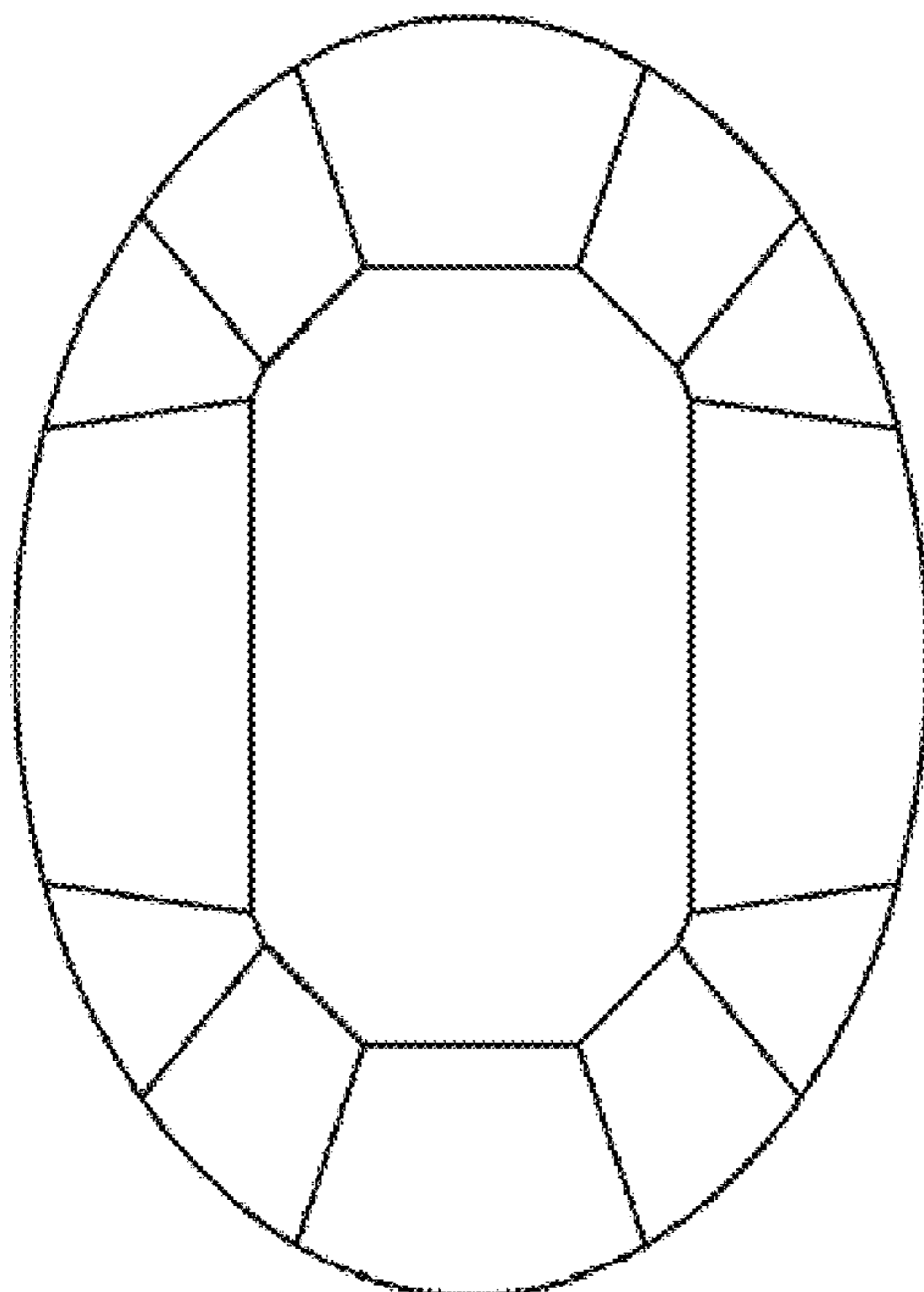

FIG. 1

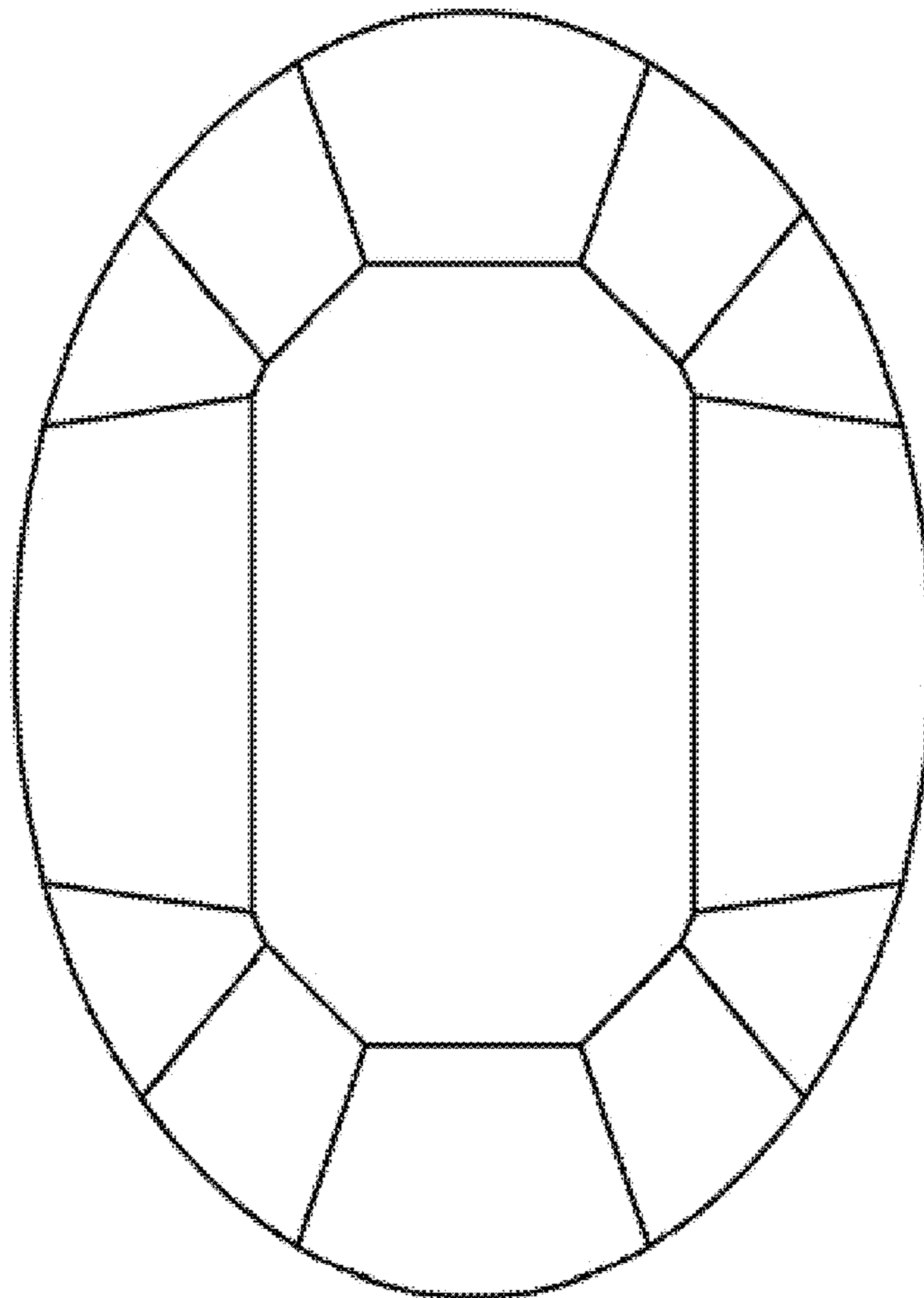

FIG. 2

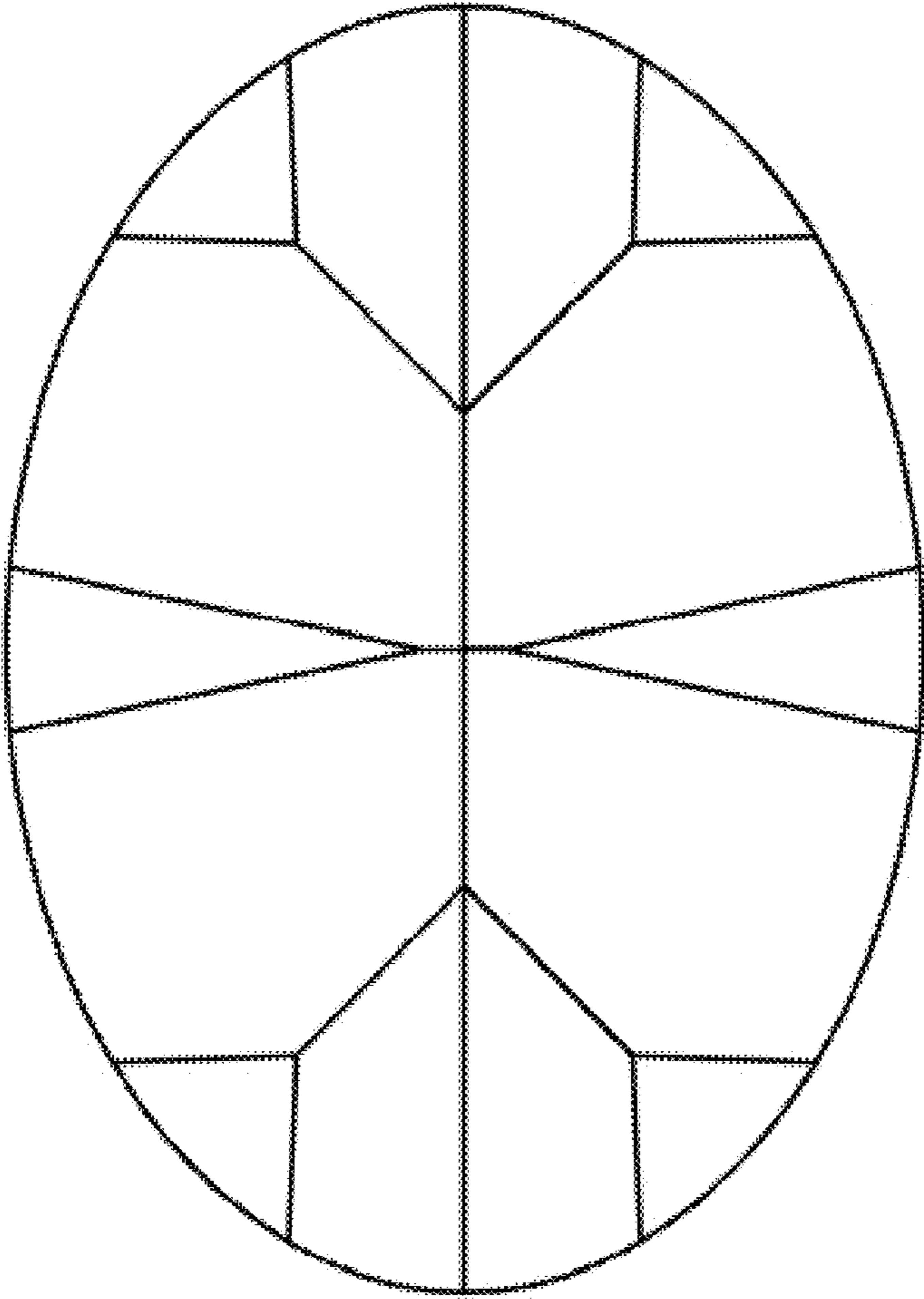

FIG. 3

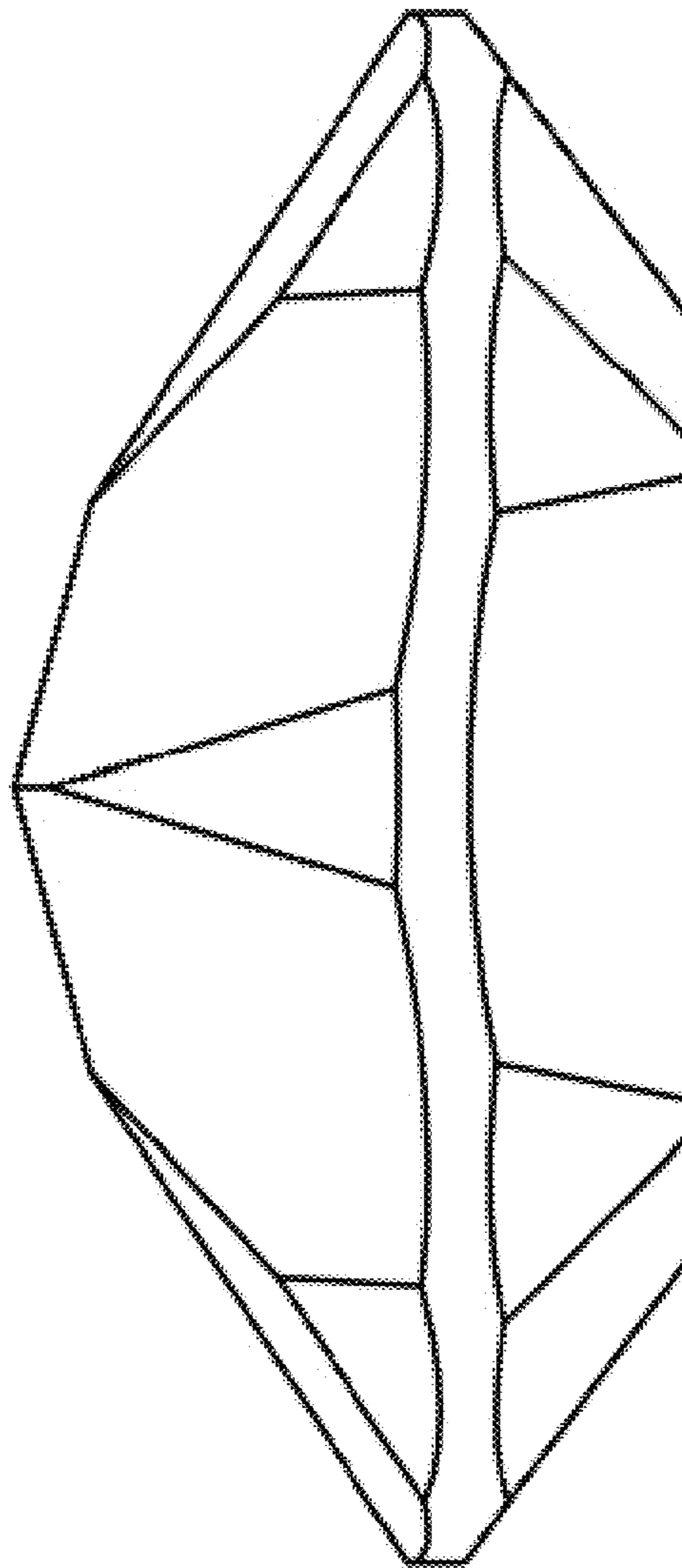

FIG. 4

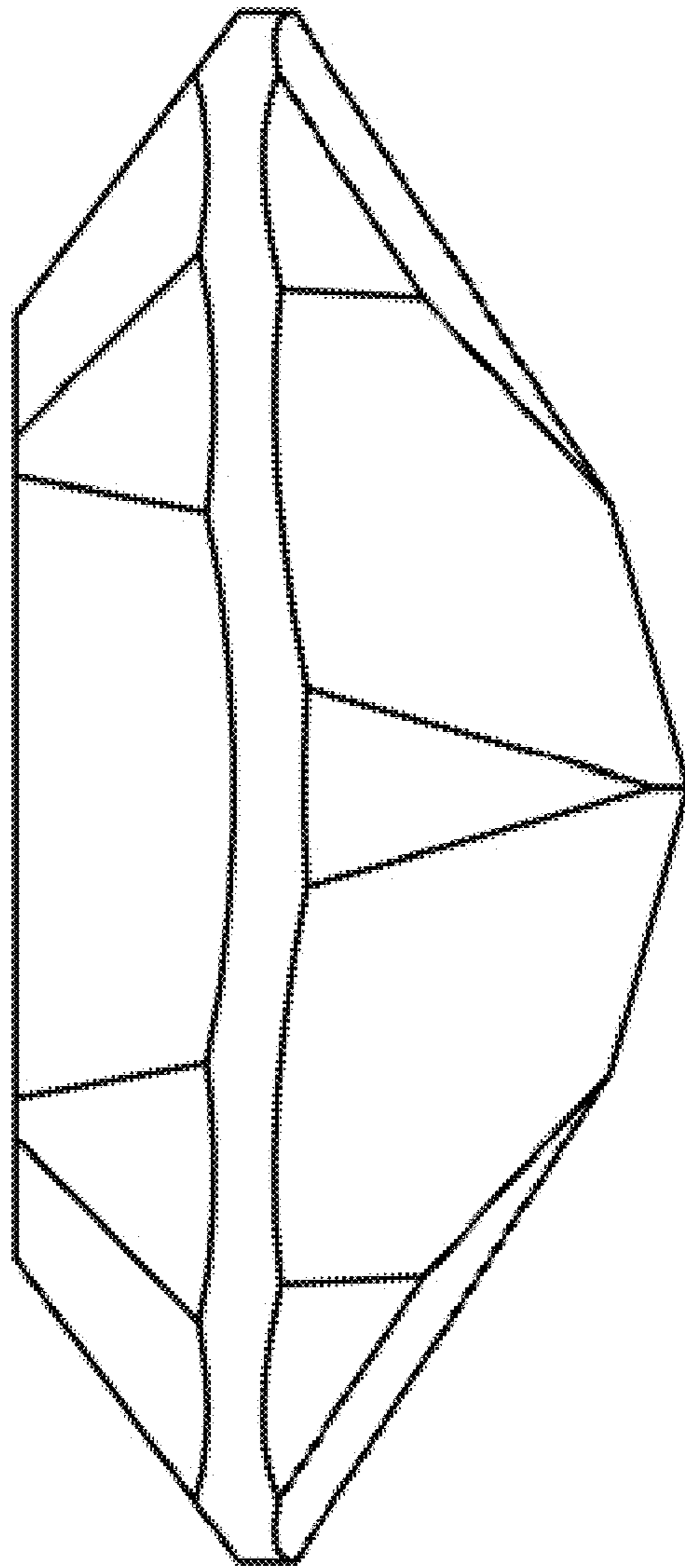

FIG. 5

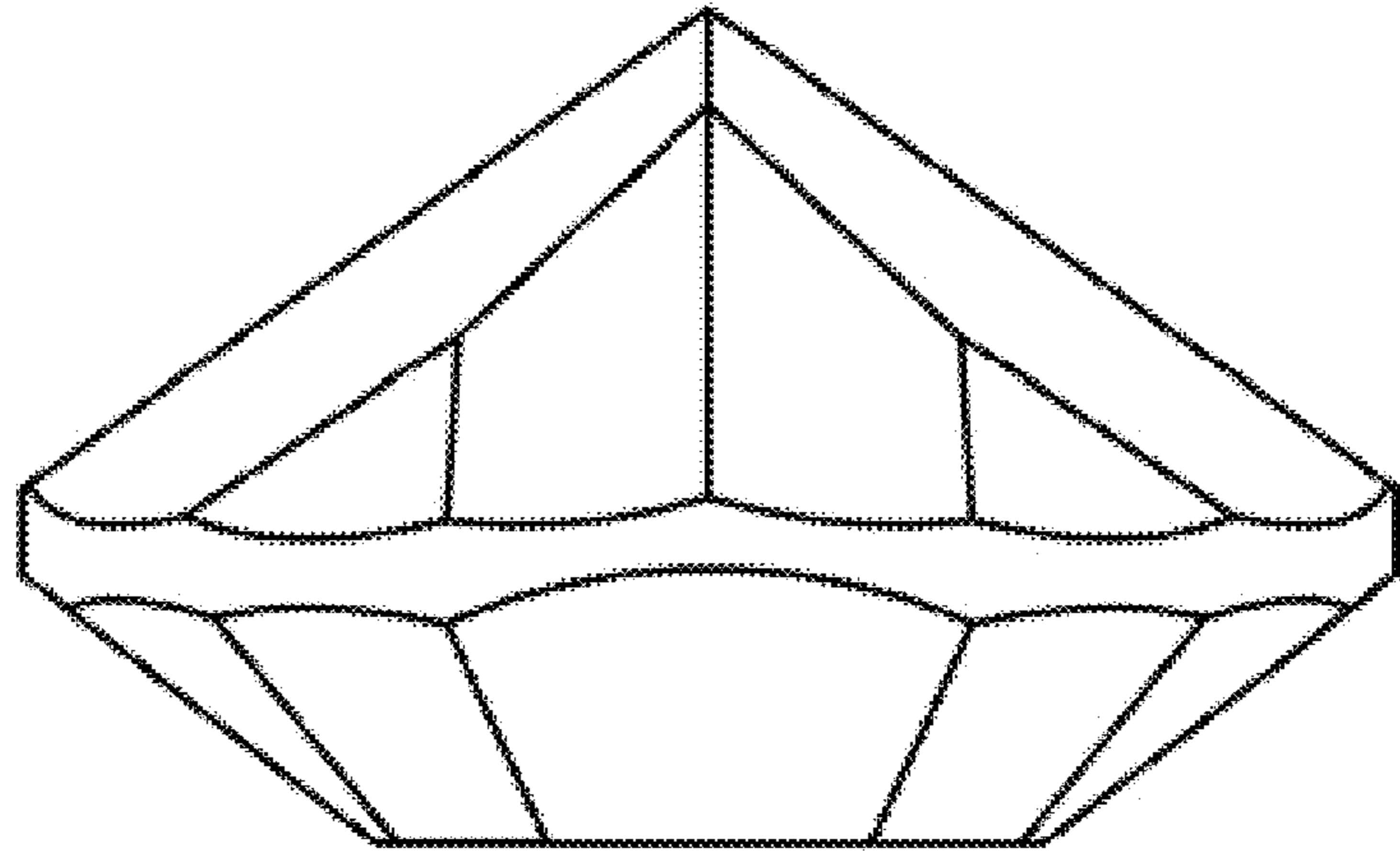

FIG. 6

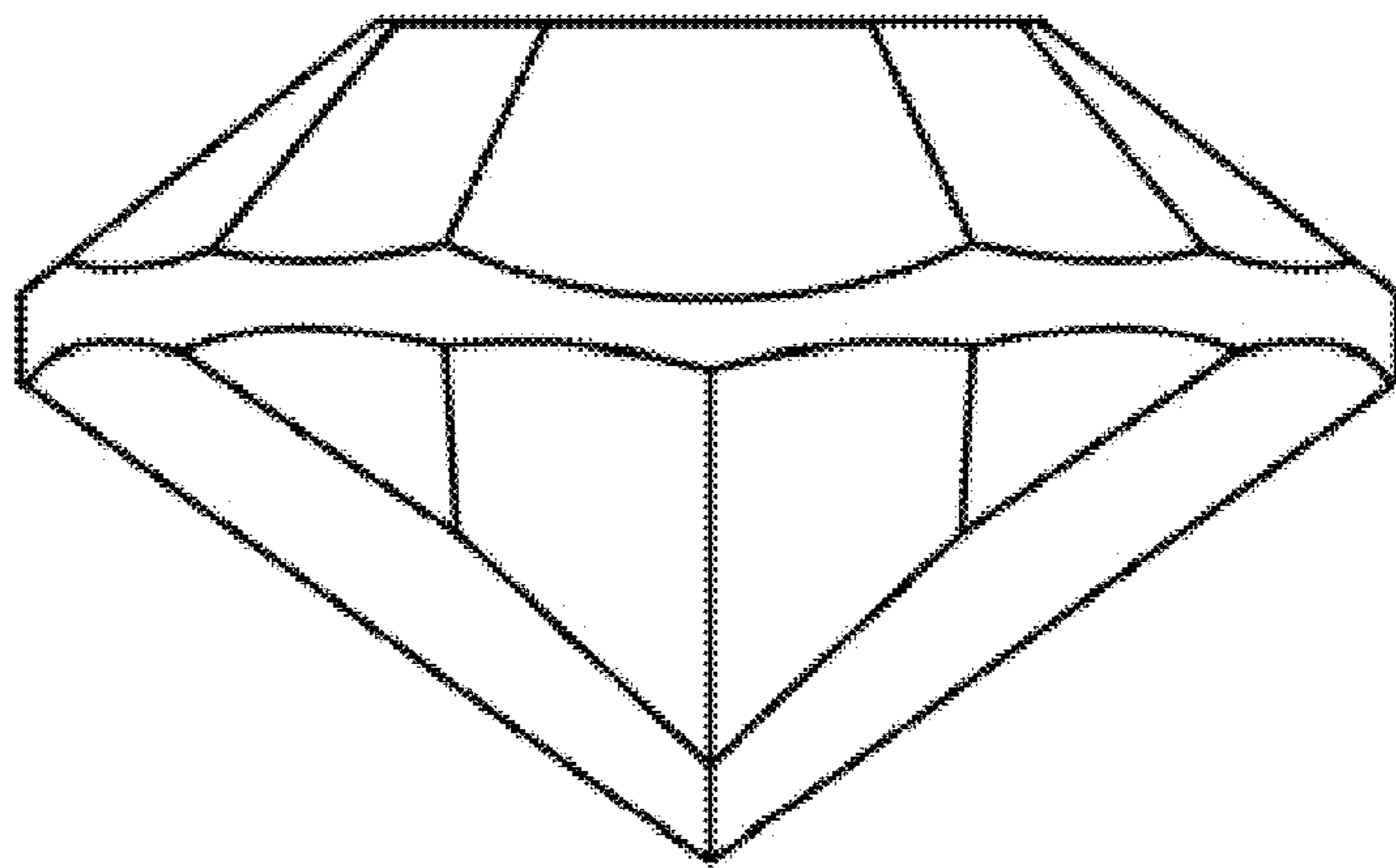

FIG. 7

