



US00D647621S

(12) **United States Design Patent**
Lee et al.

(10) **Patent No.:** **US D647,621 S**
(45) **Date of Patent:** **** Oct. 25, 2011**

(54) **PORTABLE URINE ANALYZER**

(75) Inventors: **Dae-Sik Lee**, Daejeon (KR); **Seon-Hee Park**, Daejeon (KR); **Moon Youn Jung**, Daejeon (KR)

(73) Assignee: **Electronics and Telecommunications Research Institute**, Daejeon (KR)

(**) Term: **14 Years**

(21) Appl. No.: **29/361,124**

(22) Filed: **May 5, 2010**

(30) **Foreign Application Priority Data**

Feb. 18, 2010 (KR) 30-2010-0007188

(51) **LOC (9) Cl.** **24-01**

(52) **U.S. Cl.** **D24/186**

(58) **Field of Classification Search** D24/169,
D24/186, 216, 231-232; D10/81; 422/56,
422/58, 61, 63, 65, 67, 99, 102, 104; 436/43,
436/46, 50, 55, 180; 600/309, 318, 322,
600/368, 583

See application file for complete search history.

(56) **References Cited**

U.S. PATENT DOCUMENTS

D285,113 S * 8/1986 Williams D24/216
D285,114 S * 8/1986 Collister et al. D10/81
D347,478 S * 5/1994 Pinkney D24/232
D359,357 S * 6/1995 Bigler et al. D24/231
D369,216 S * 4/1996 Micinski et al. D24/169
D369,864 S * 5/1996 Petersen D24/169

D371,440 S * 7/1996 Petersen D24/186
D376,651 S * 12/1996 Paloian D24/216
D467,349 S * 12/2002 Niedbala et al. D24/232
D585,993 S * 2/2009 Kousuge D24/186
D616,993 S * 6/2010 Muis et al. D24/186

* cited by examiner

Primary Examiner — T. Chase Nelson
Assistant Examiner — Mark Cavanna

(57) **CLAIM**

The ornamental design for a portable urine analyzer, as shown and described.

DESCRIPTION

FIG. 1 is a perspective view of a portable urine analyzer showing our new design;
FIG. 2 is a front elevational view thereof;
FIG. 3 is a rear elevational view thereof;
FIG. 4 is a left side elevational view thereof;
FIG. 5 is a right side elevational view thereof;
FIG. 6 is a top plan view thereof;
FIG. 7 is a bottom plan view thereof; and,
FIG. 8 is a reference view showing a use state of a disposable urine test strip.

The broken lines are included for the purpose of illustrating unclaimed portions of the portable urine analyzer and form no part of the claimed design. The broken line test strip in FIG. 8 depicts environment, and also forms no part of the claimed design.

1 Claim, 5 Drawing Sheets

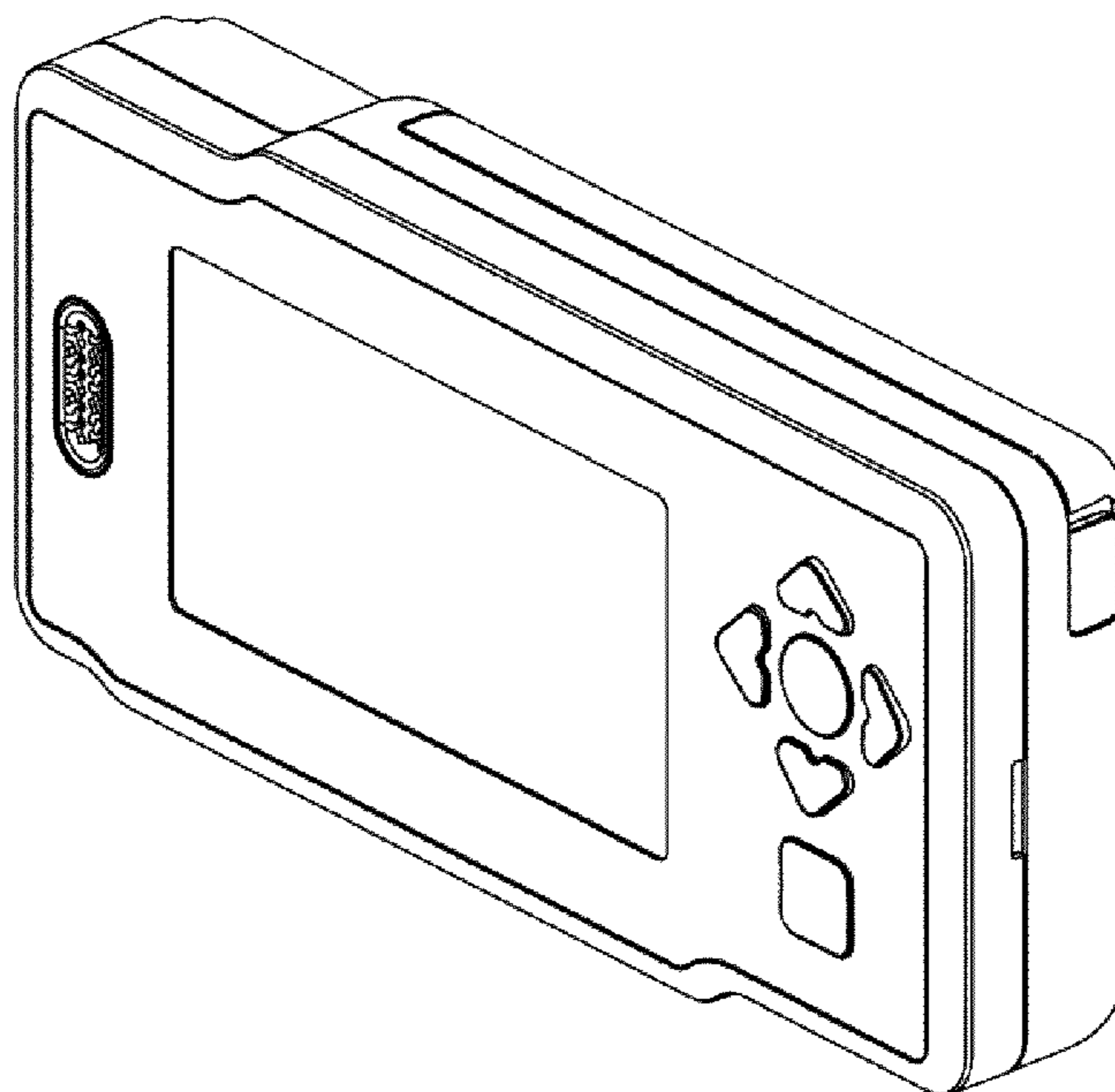

Fig. 1

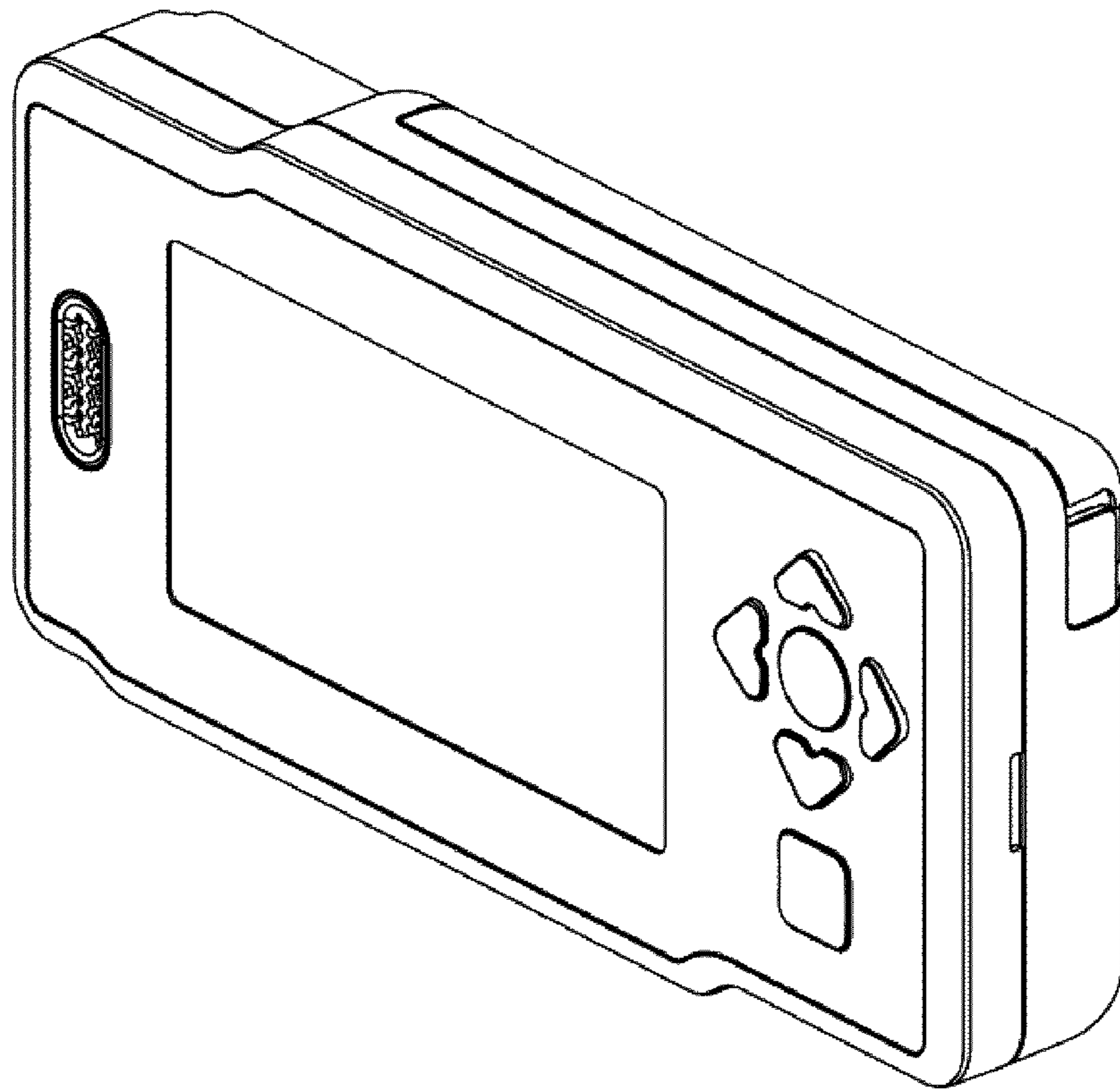

Fig. 2

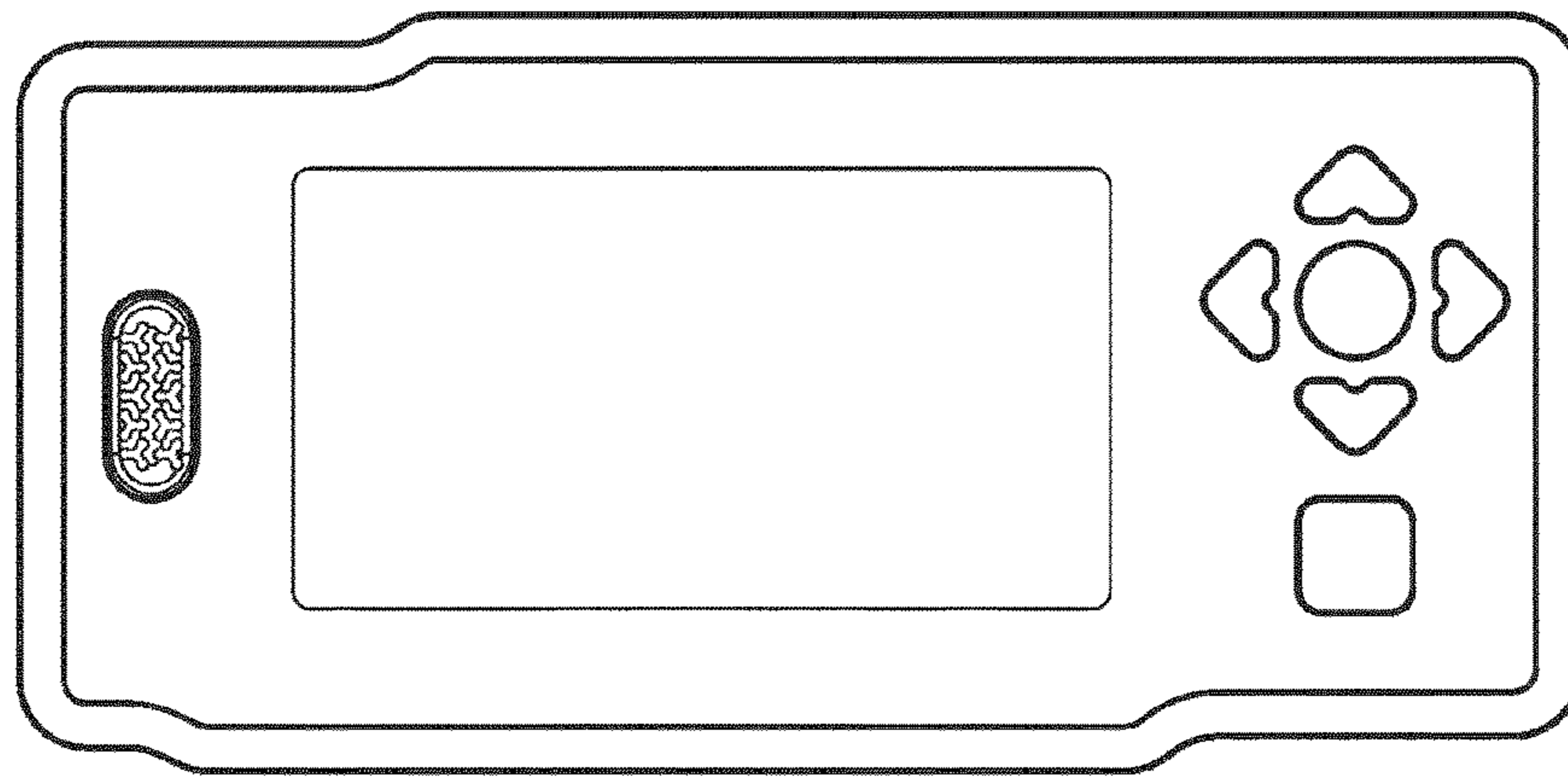

Fig. 3

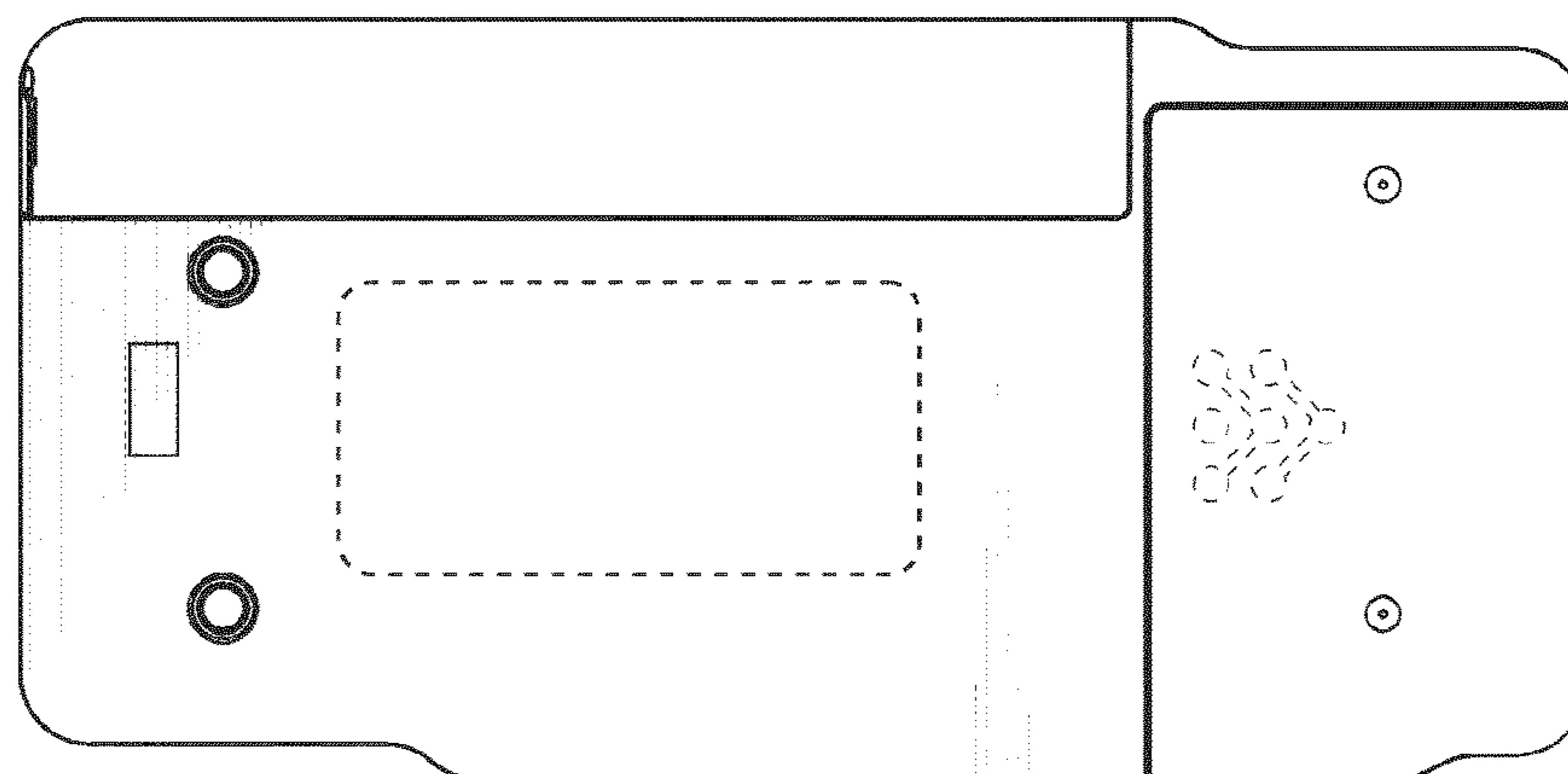

Fig. 4

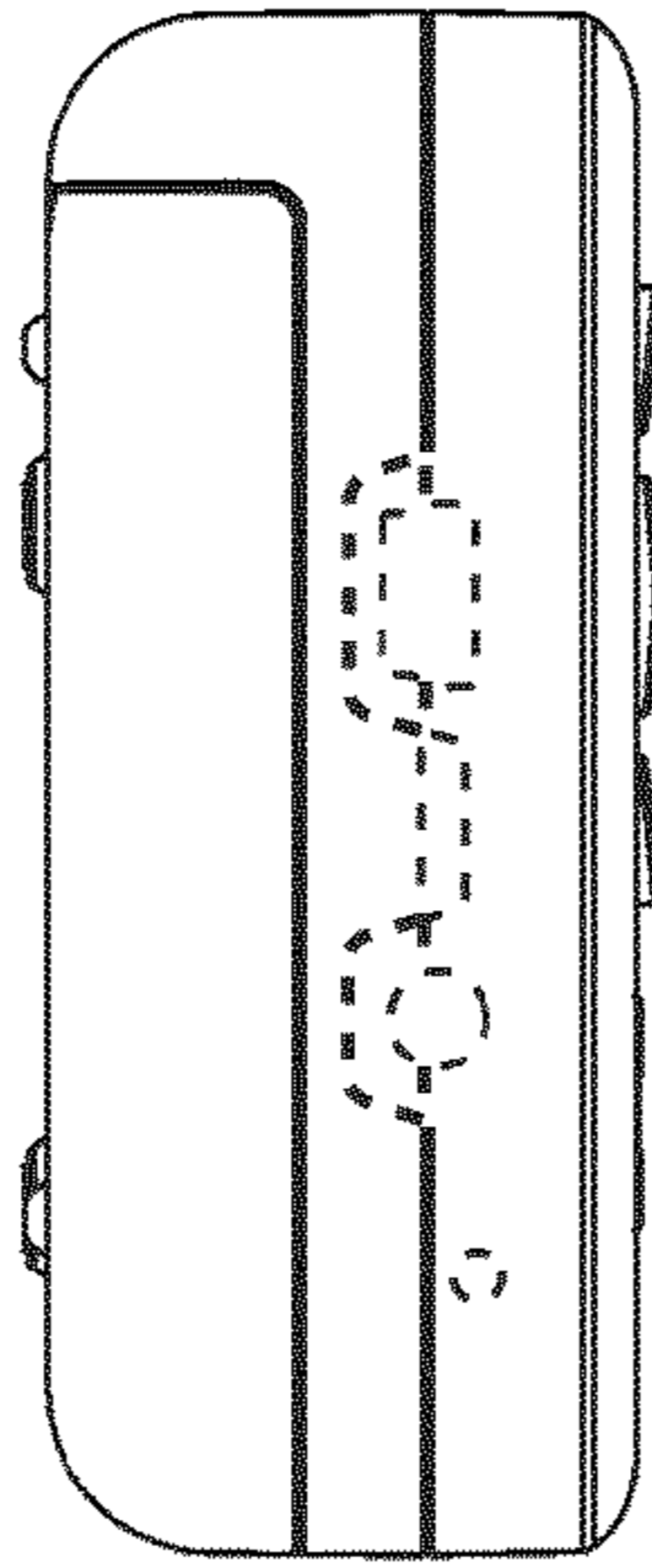

Fig. 5

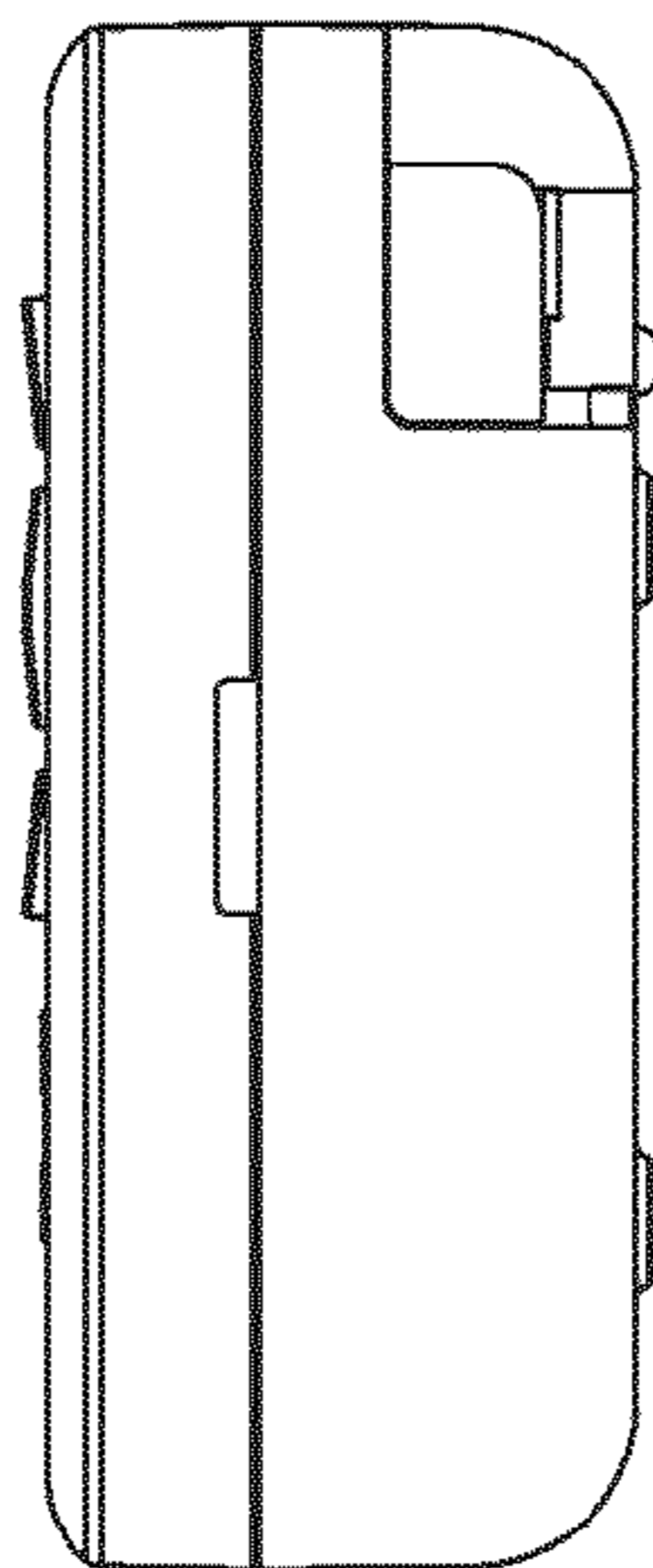

Fig. 6

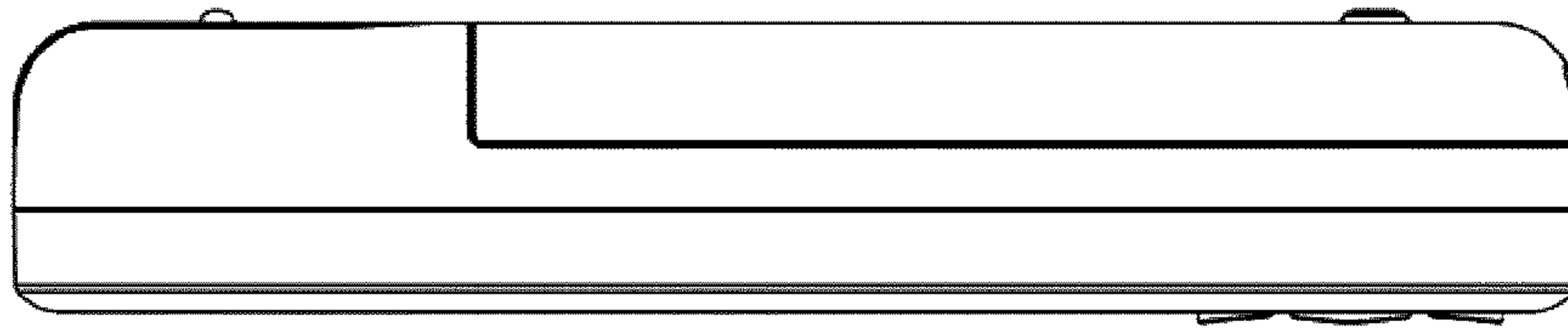

Fig. 7

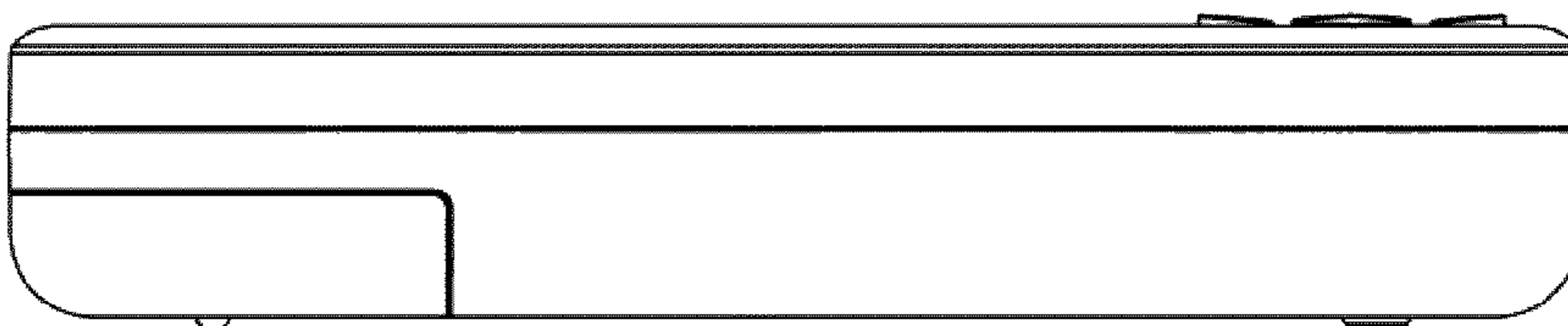

Fig. 8

