



US00D647592S

(12) **United States Design Patent**
Fenstermaker

(10) **Patent No.:** **US D647,592 S**

(45) **Date of Patent:** **** Oct. 25, 2011**

(54) **FROG-SHAPED FISHING LURE**
(75) Inventor: **Matthew Fenstermaker**, Macungie, PA
(US)

(73) Assignee: **Revere Maxx Fishing**, Macungie, PA
(US)

(**) Term: **14 Years**

(21) Appl. No.: **29/383,630**

(22) Filed: **Jan. 20, 2011**

(51) **LOC (9) Cl.** **22-05**

(52) **U.S. Cl.** **D22/132**

(58) **Field of Classification Search** D22/126-133;
43/42.3, 42.03, 42.06, 42.15, 42.02, 42.13,
43/42.28, 42.29, 42.26, 42.35, 42.36, 42.48,
43/44.82; D21/597, 599

See application file for complete search history.

(56) **References Cited**

U.S. PATENT DOCUMENTS

2,495,021	A *	1/1950	Pruden	43/42.48
2,803,915	A *	8/1957	Zwiercan	43/42.06
D297,557	S	9/1988	Dundan		
4,831,767	A *	5/1989	Pearce	43/42.3
D329,487	S	9/1992	Pruiksmas		
D330,244	S	10/1992	Pruiksmas		
D340,502	S	10/1993	Lynch		
D390,336	S	2/1998	Phelps		
D439,629	S	3/2001	Nelson		
D495,397	S	8/2004	Pearce		
D502,981	S	3/2005	Chambers, Sr.		

D509,278	S	9/2005	Chambers, Sr.		
D537,909	S	3/2007	Littlejohn		
D604,797	S *	11/2009	Van Iseghem, Jr.	D22/132
D624,148	S *	9/2010	Renosky	D22/132

* cited by examiner

Primary Examiner — Catheri Oliver

(74) *Attorney, Agent, or Firm* — Kilpatrick Townsend & Stockton LLP

(57) **CLAIM**

The ornamental design for a frog-shaped fishing lure, as shown and described.

DESCRIPTION

FIG. 1 is a perspective view of a frog-shaped fishing lure showing my new design;
FIG. 2 is a right side elevational view thereof;
FIG. 3 is a left side elevational view thereof;
FIG. 4 is a top plan view thereof;
FIG. 5 is a bottom plan view thereof;
FIG. 6 is a front elevational view thereof;
FIG. 7 is a rear elevational view thereof;
FIG. 8 is a perspective view of a second embodiment of a frog-shaped fishing lure showing my new design;
FIG. 9 is a right side elevational view thereof;
FIG. 10 is a left side elevational view thereof;
FIG. 11 is a top plan view thereof;
FIG. 12 is a bottom plan view thereof;
FIG. 13 is a front elevational view thereof; and,
FIG. 14 is a rear elevational view thereof.
The portions shown in broken lines form no part of the claimed design.

1 Claim, 9 Drawing Sheets

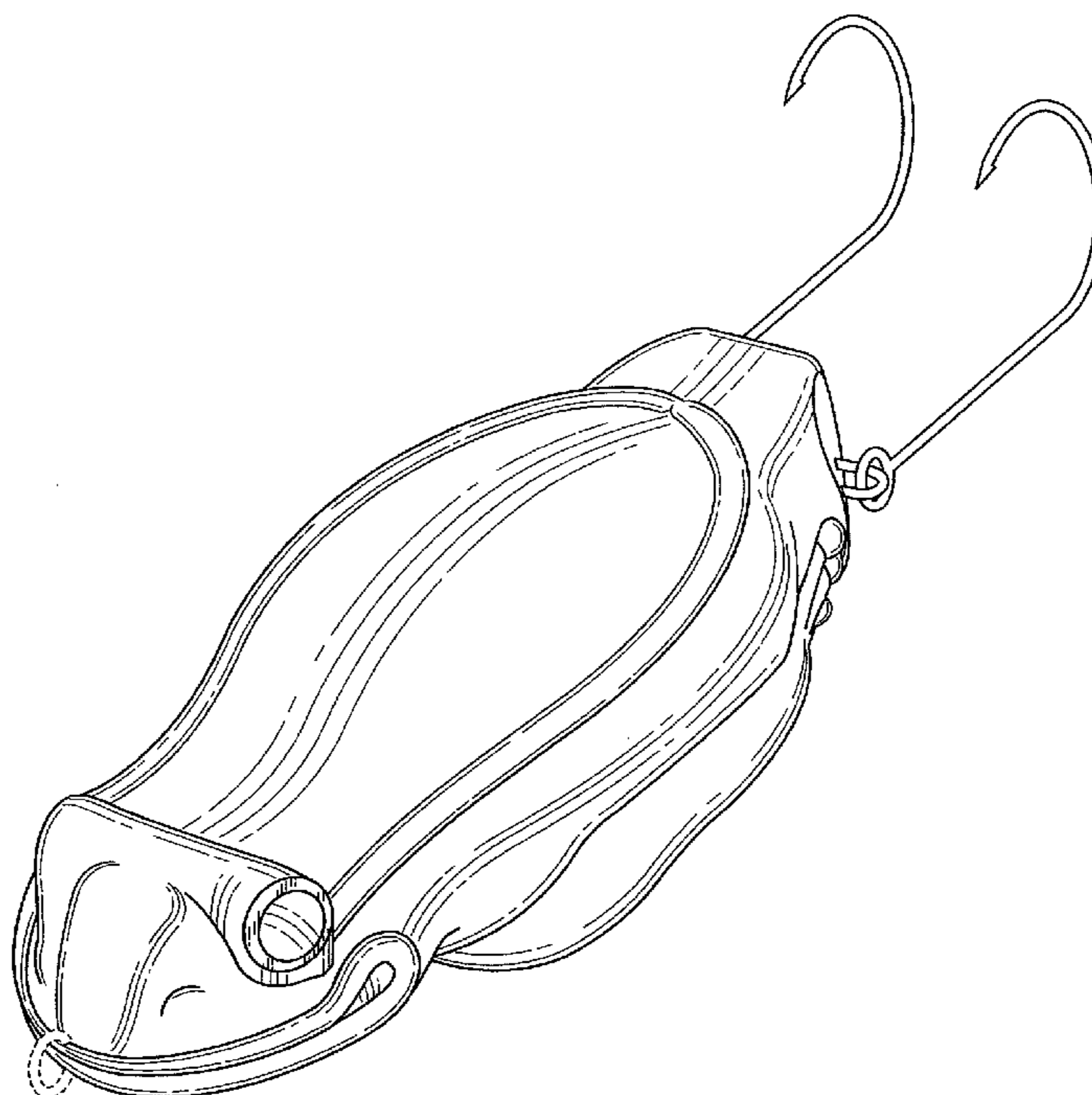

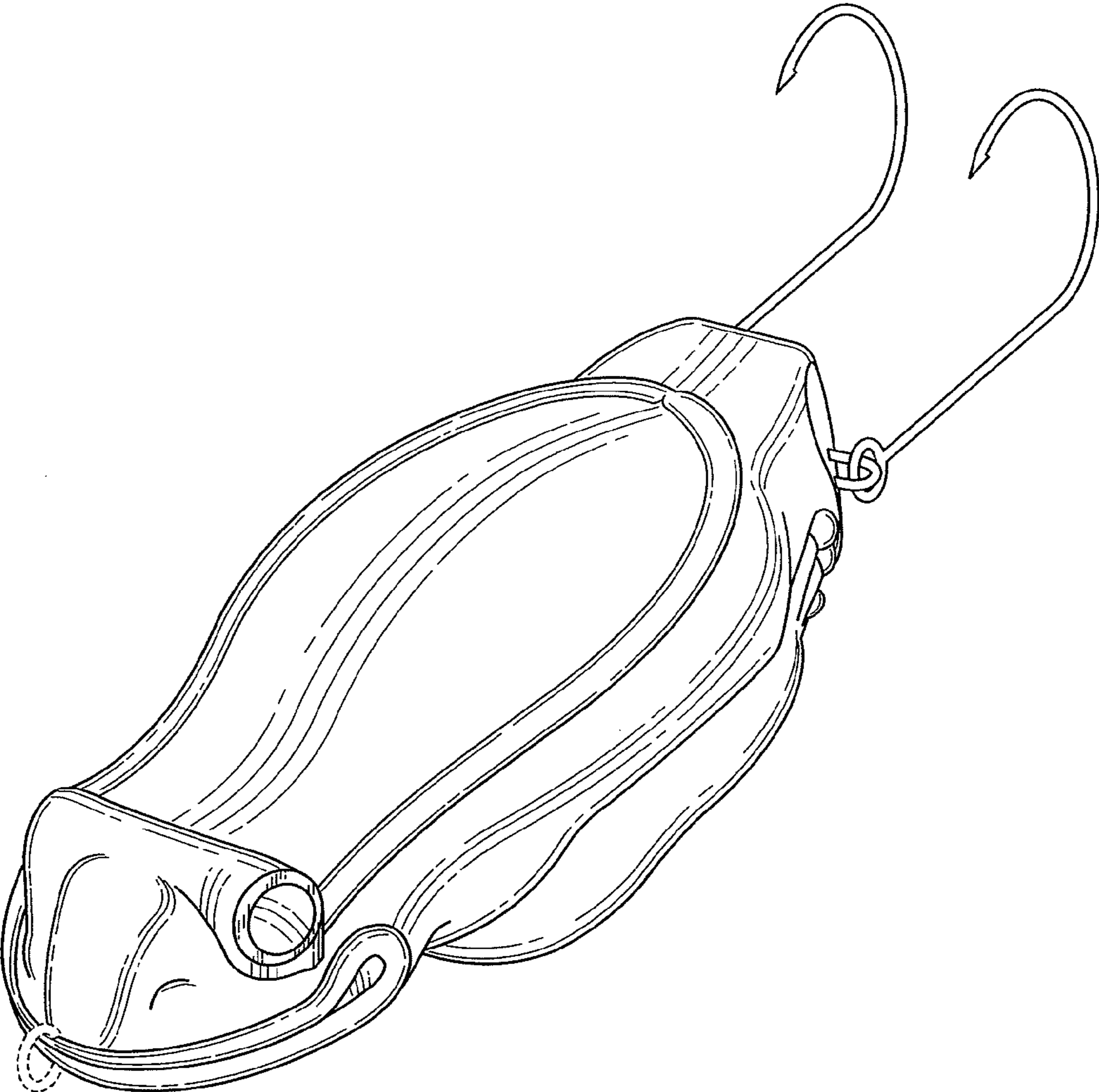

FIG. 1

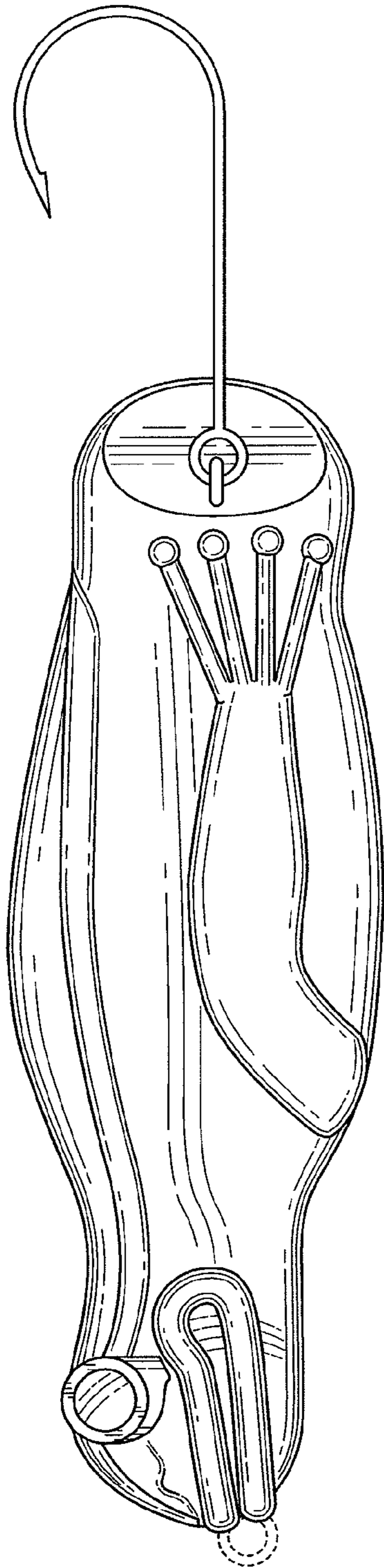

FIG. 2

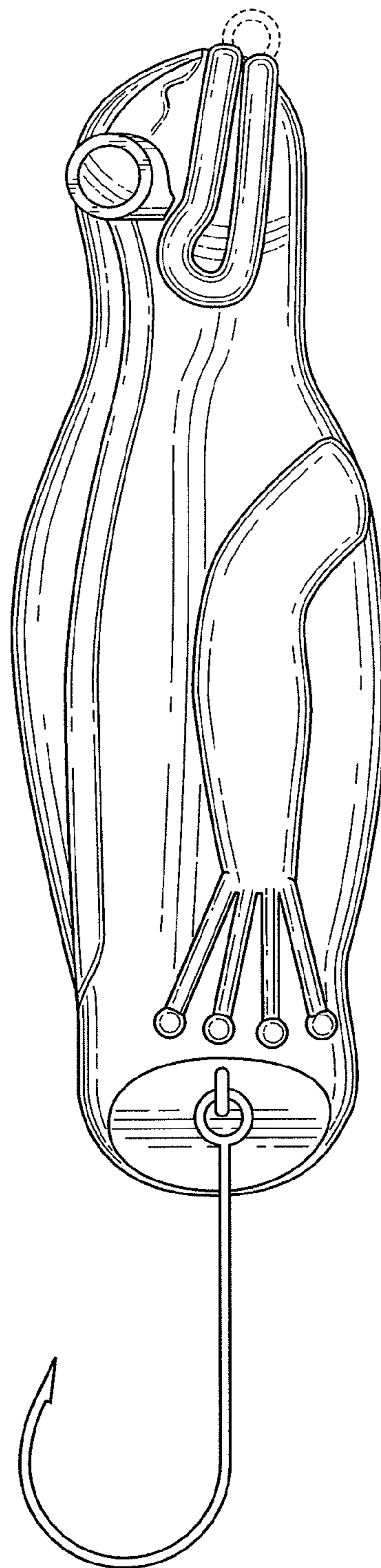

FIG. 3

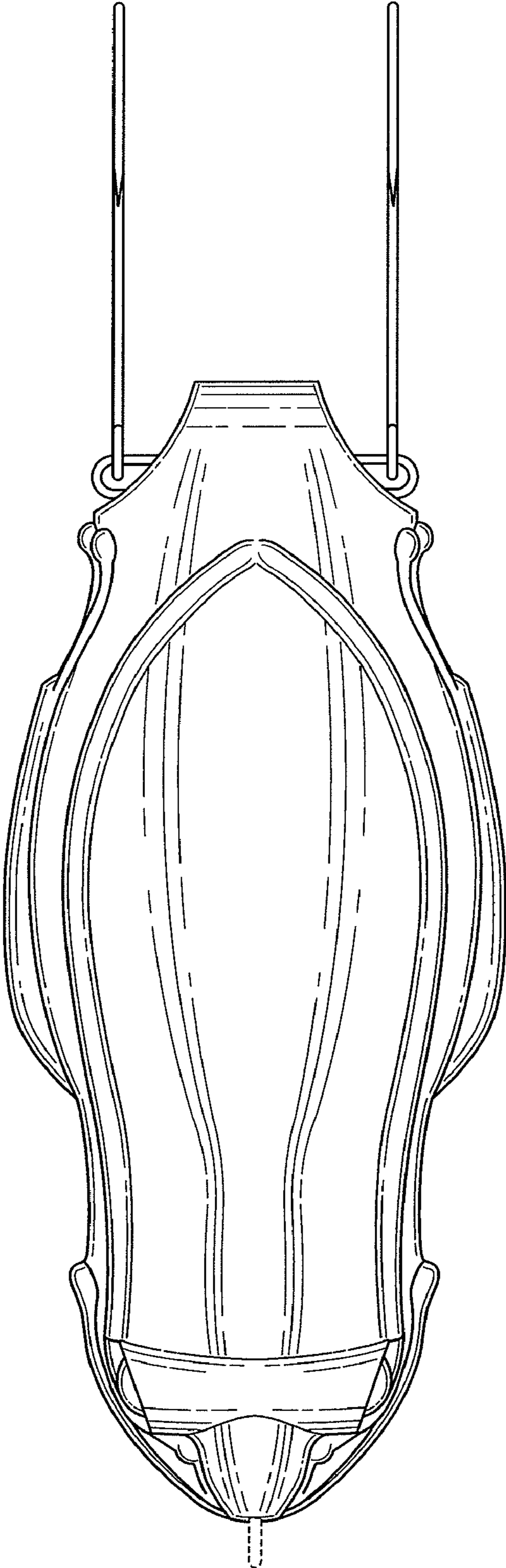

FIG. 4

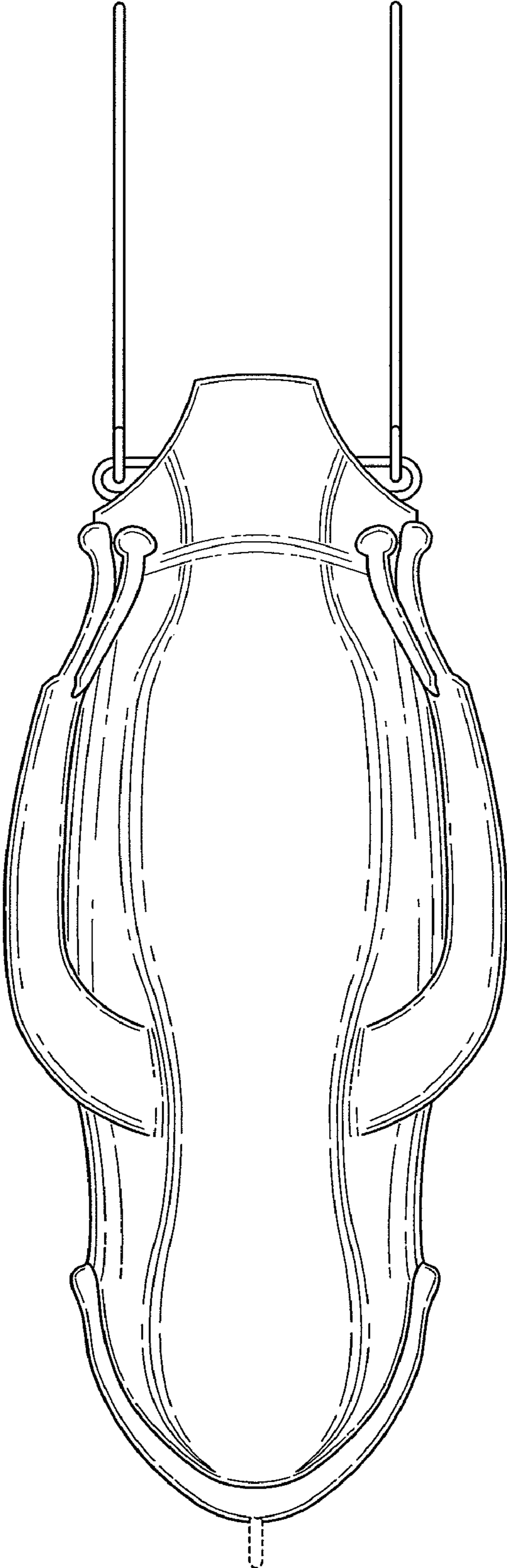

FIG. 5

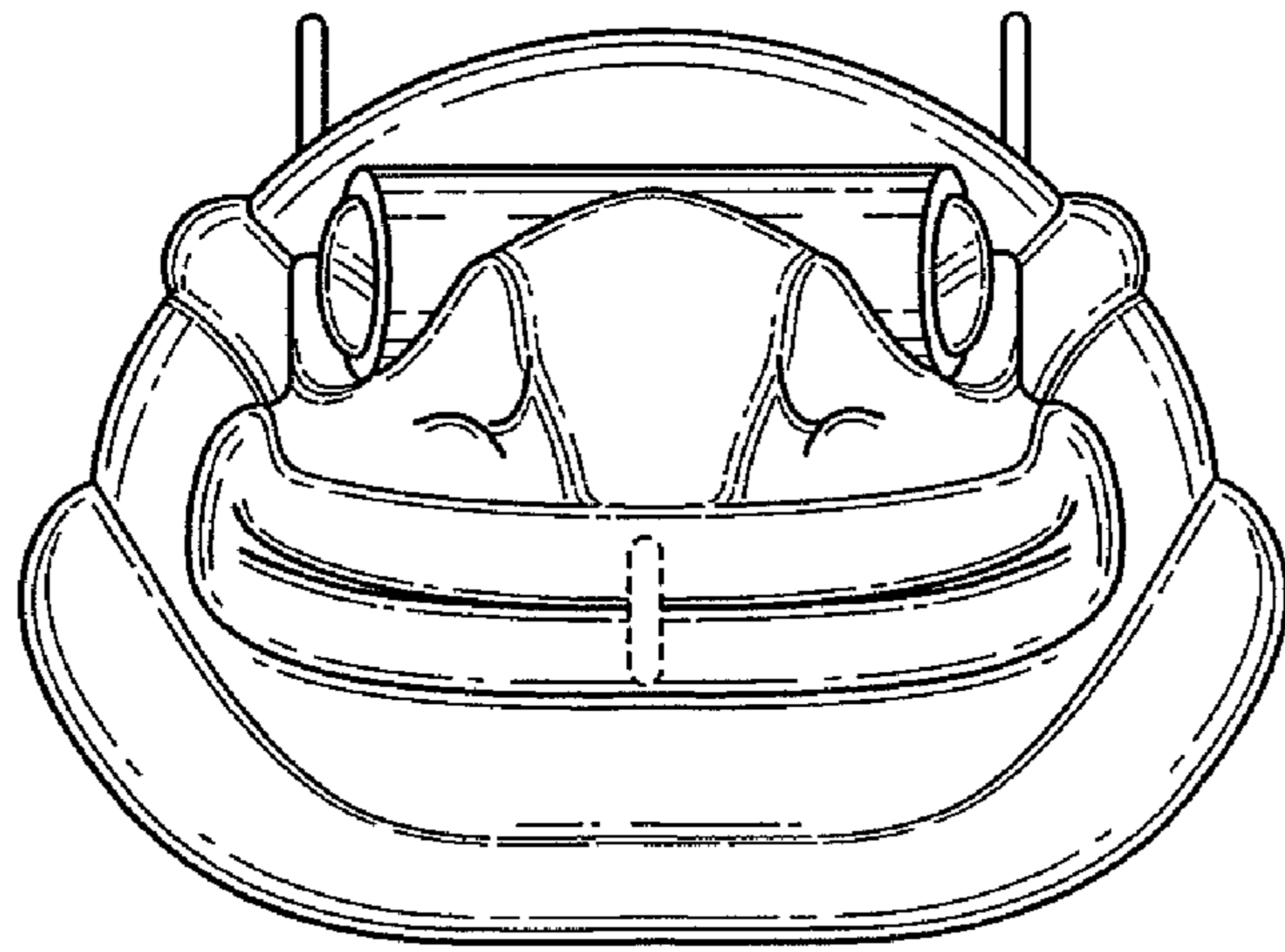

FIG. 6

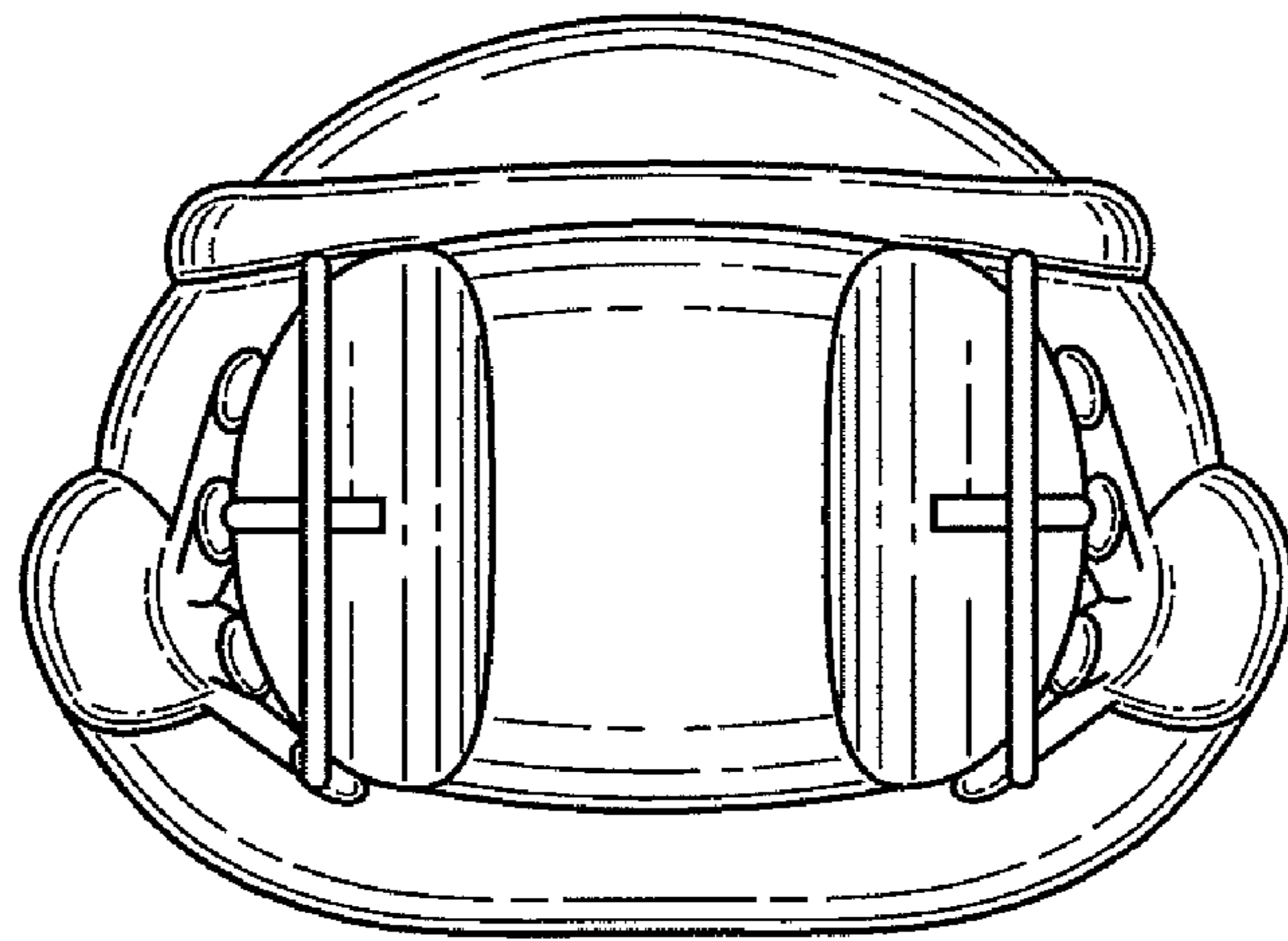

FIG. 7

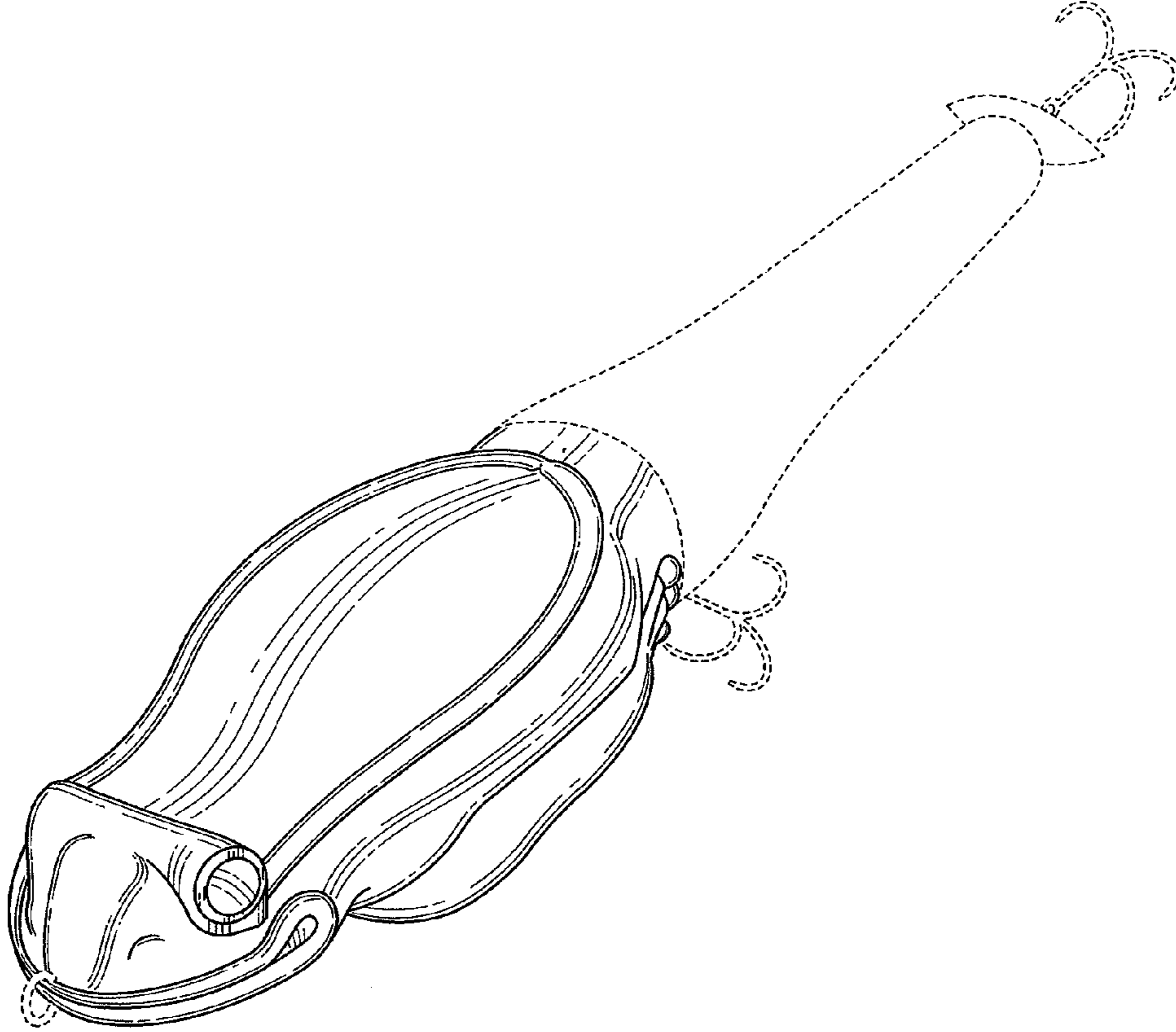
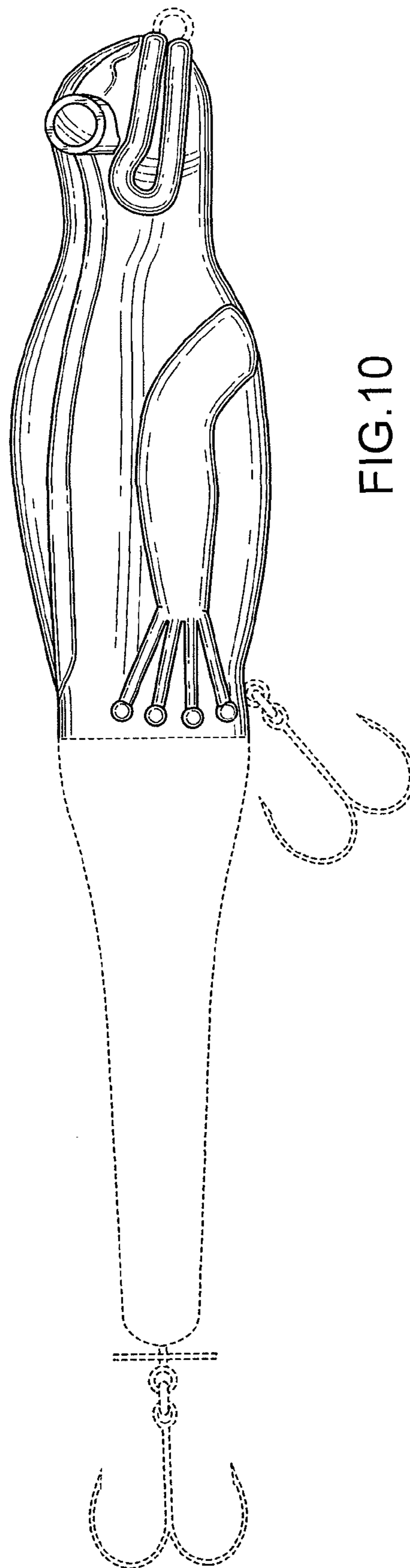
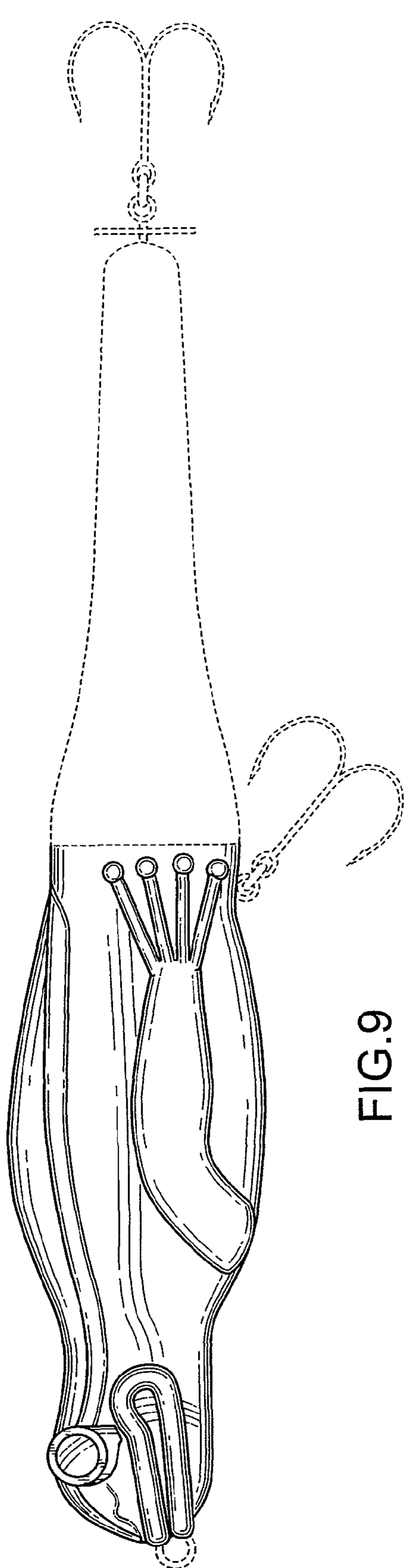

FIG. 8



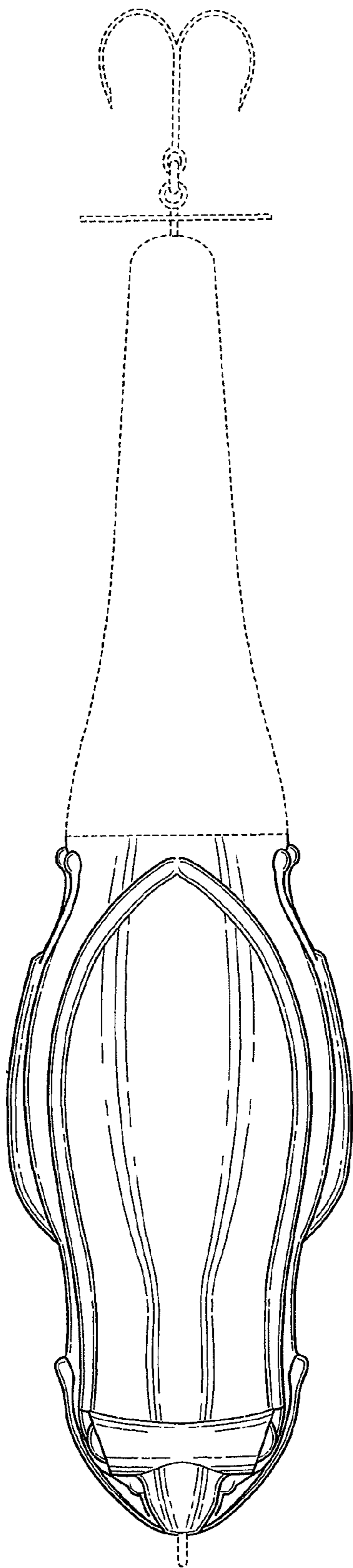

FIG. 11

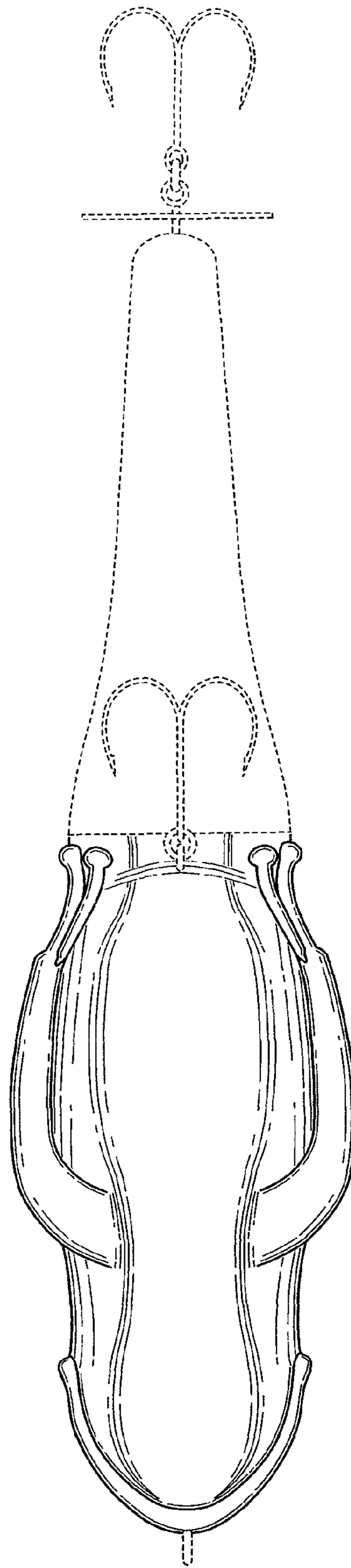

FIG. 12

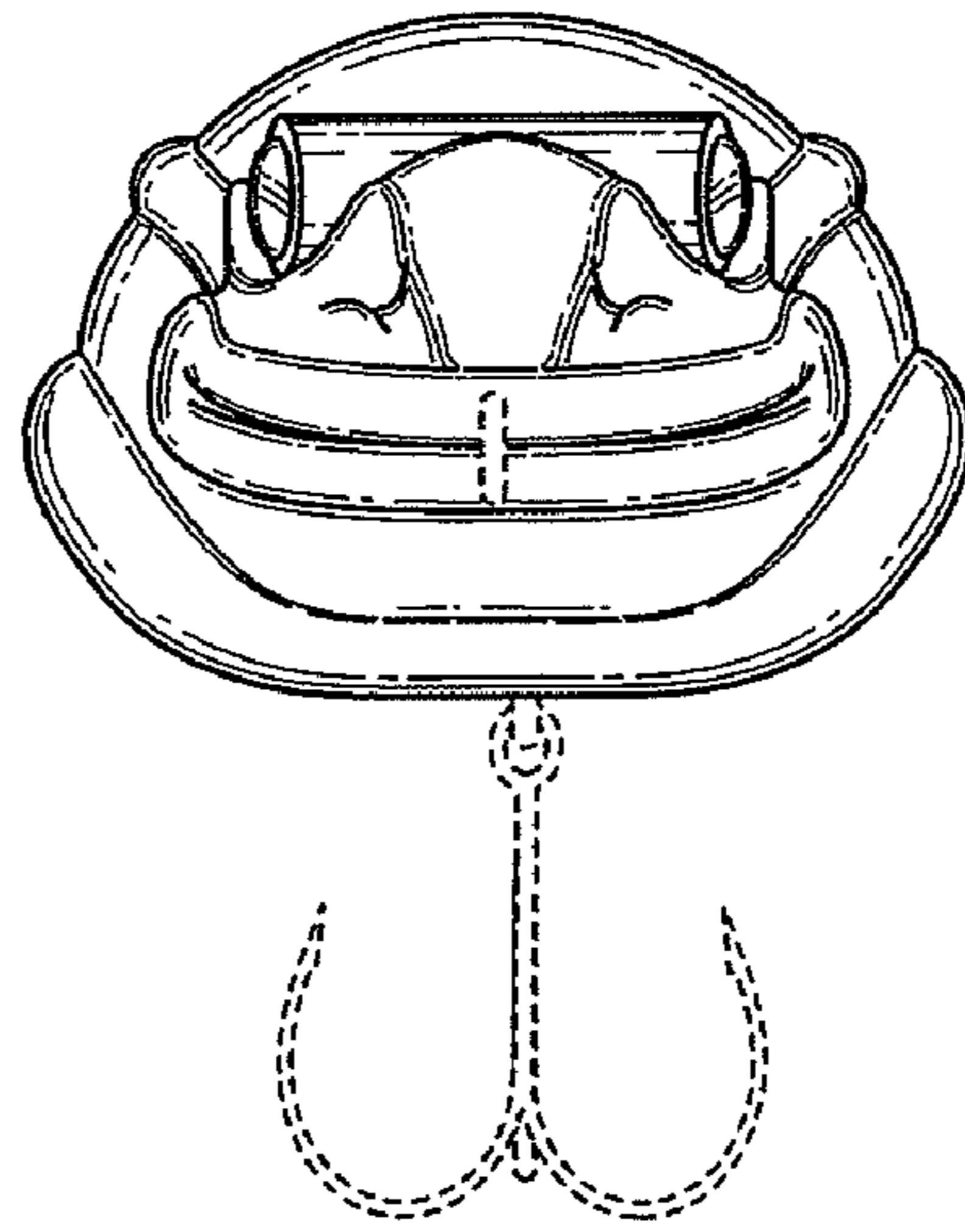

FIG.13

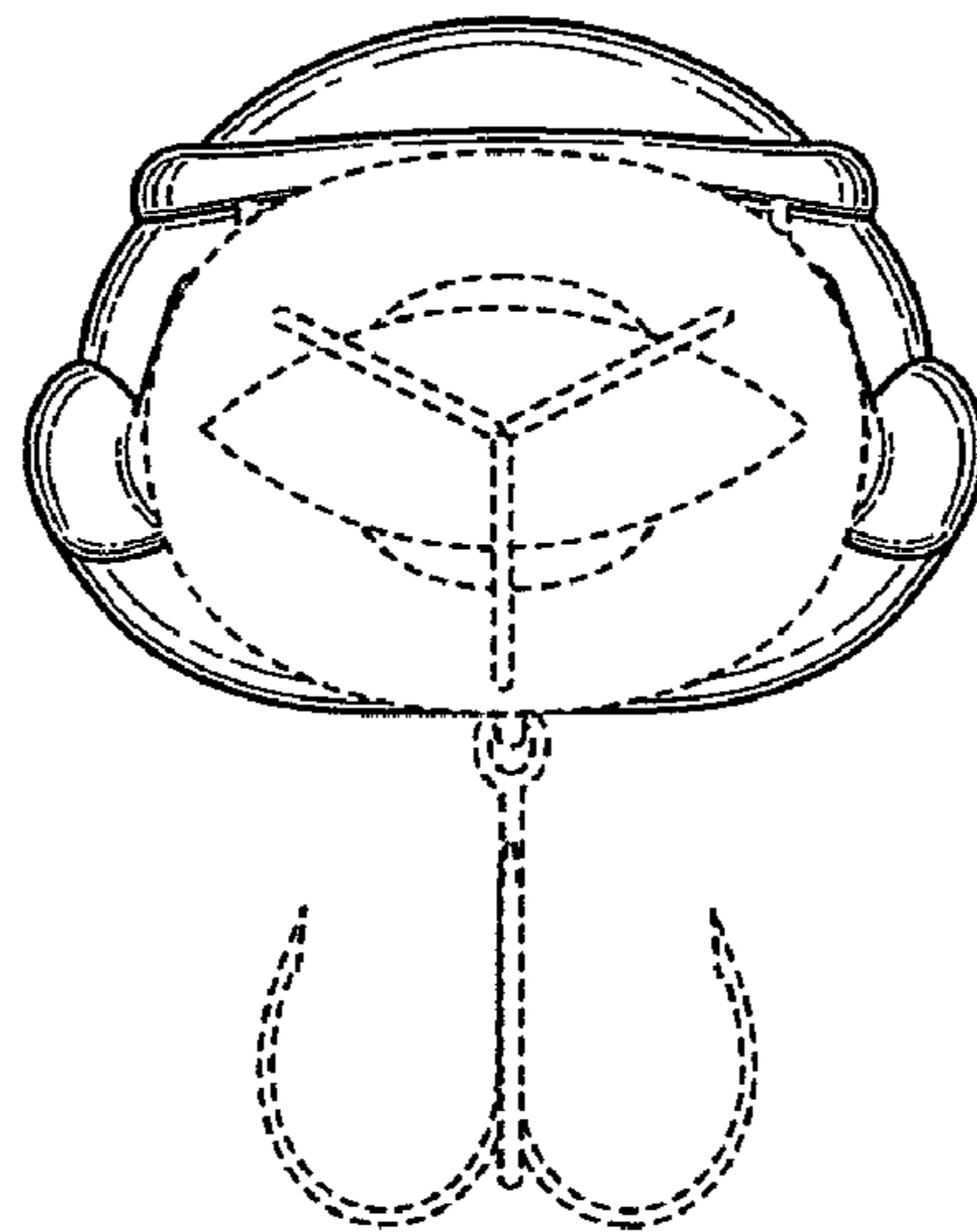

FIG.14