



US00D647556S

(12) **United States Design Patent**
Chen

(10) **Patent No.:** **US D647,556 S**

(45) **Date of Patent:** **** Oct. 25, 2011**

(54) **ENGLISH ALPHABET TYPE FONT**

D51,259 S * 9/1917 Divine D18/24
D292,417 S * 10/1987 O'Neal D18/30
D633,001 S * 2/2011 Chen D11/184

(76) **Inventor:** **Tsung-Wei Chen, Changhua (TW)**

* cited by examiner

(**) **Term:** **14 Years**

Primary Examiner — Mary Ann Calabrese

(21) **Appl. No.:** **29/376,849**

(22) **Filed:** **Oct. 13, 2010**

(57) **CLAIM**

(51) **LOC (9) Cl.** **18-03**

The ornamental design for an English alphabet type font, as shown and described.

(52) **U.S. Cl.** **D18/32**

(58) **Field of Classification Search** D18/24-33;
101/396-399; D5/63, 64; D11/184

DESCRIPTION

See application file for complete search history.

FIG. 1 is a face view of an English alphabet type font showing my new design; and, FIG. 2-27 are respective individual face views of the characters of the alphabet type font of FIG. 1 shown enlarged.

(56) **References Cited**

U.S. PATENT DOCUMENTS

D16,425 S * 12/1885 Beeler D18/24
D42,923 S * 8/1912 Mason D18/24

1 Claim, 27 Drawing Sheets

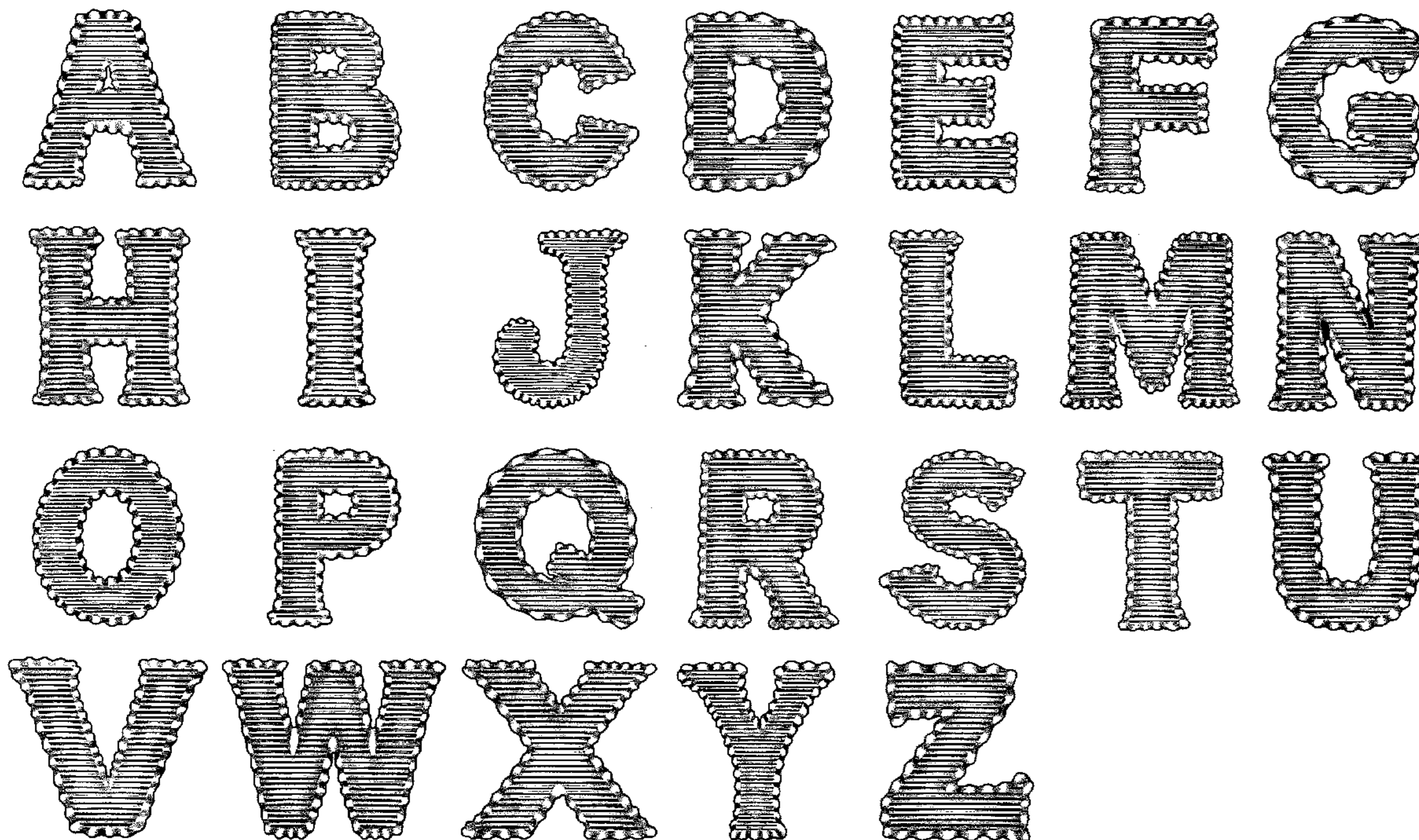

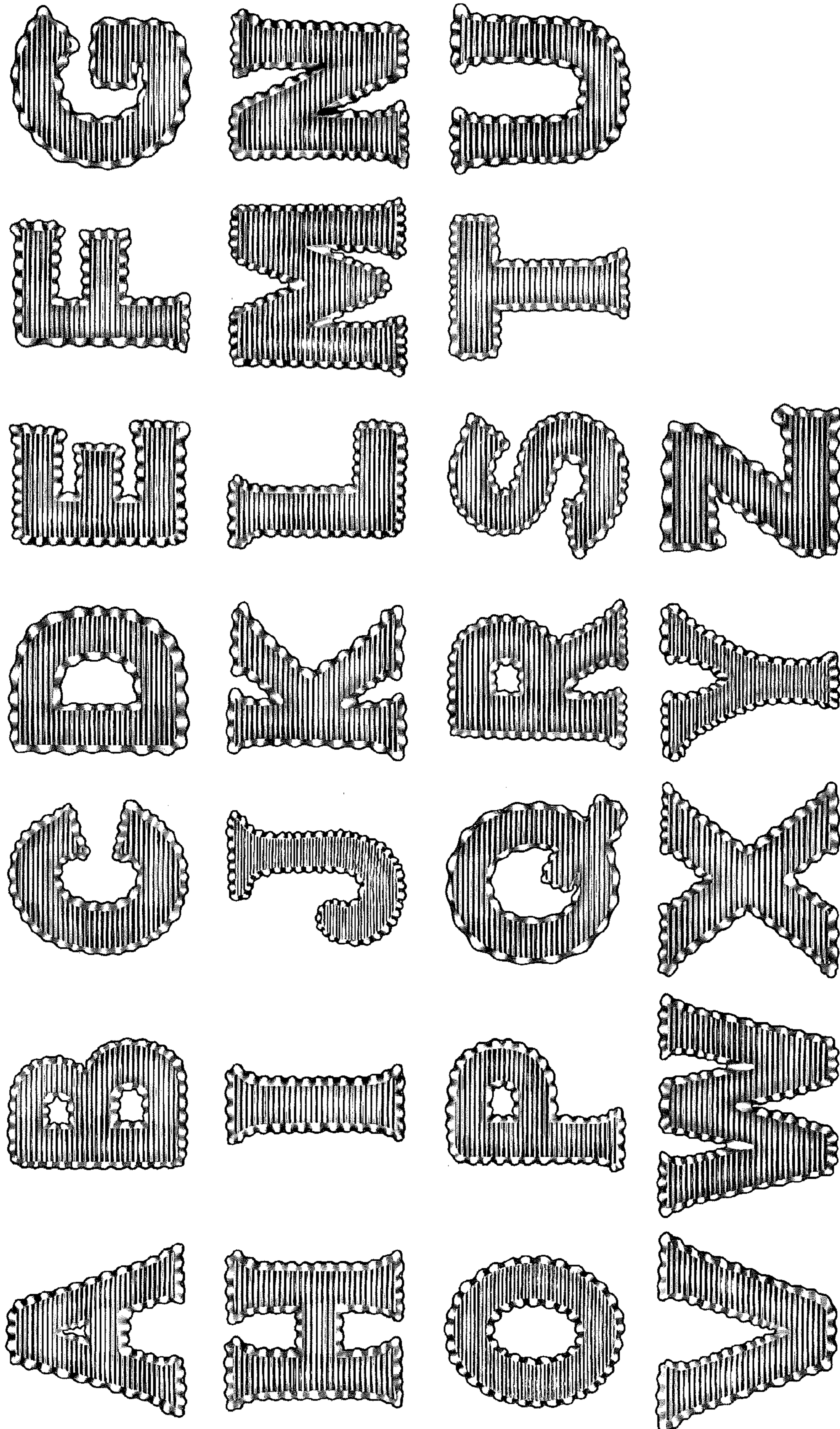

FIG. 1

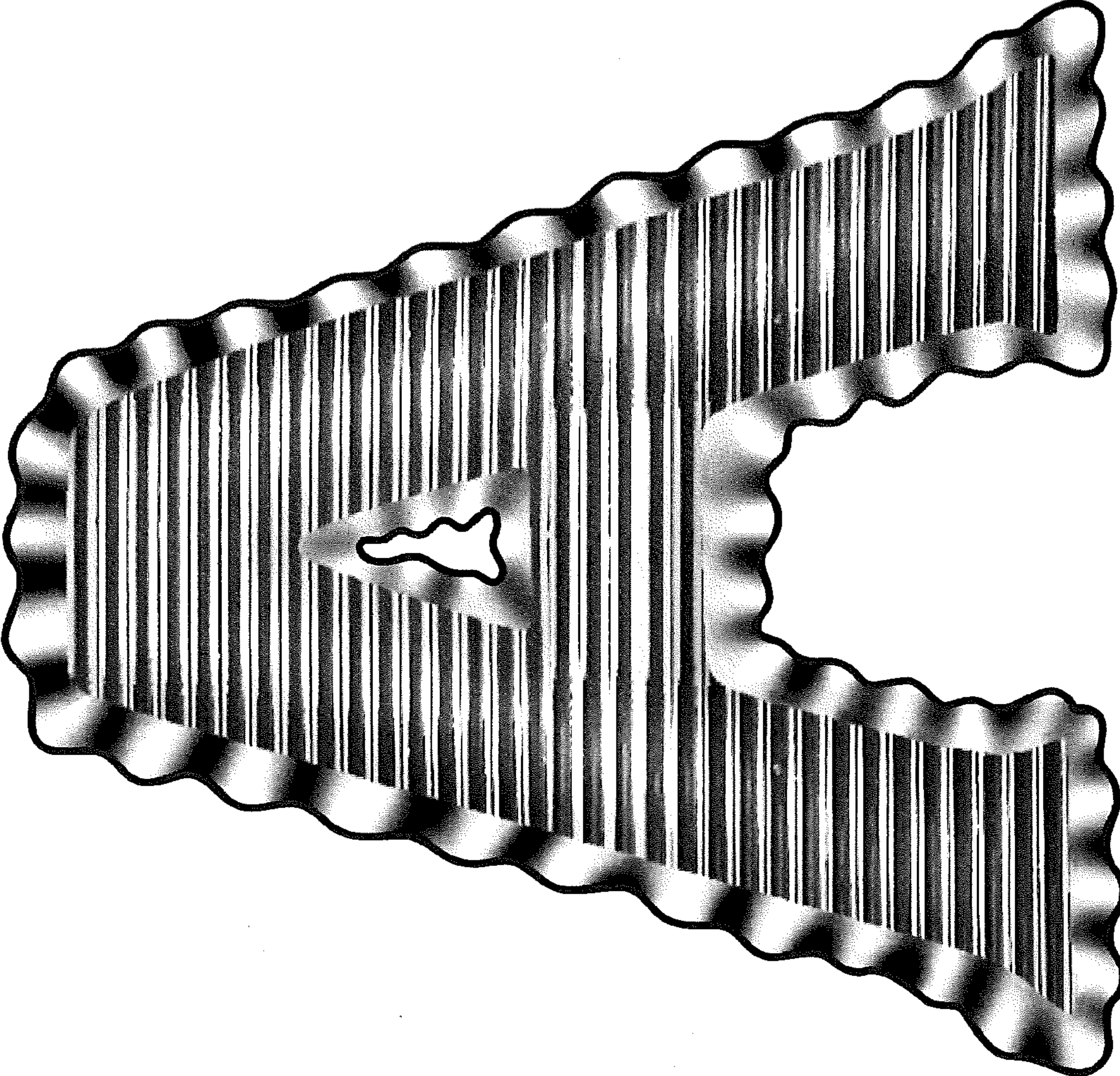

FIG. 2

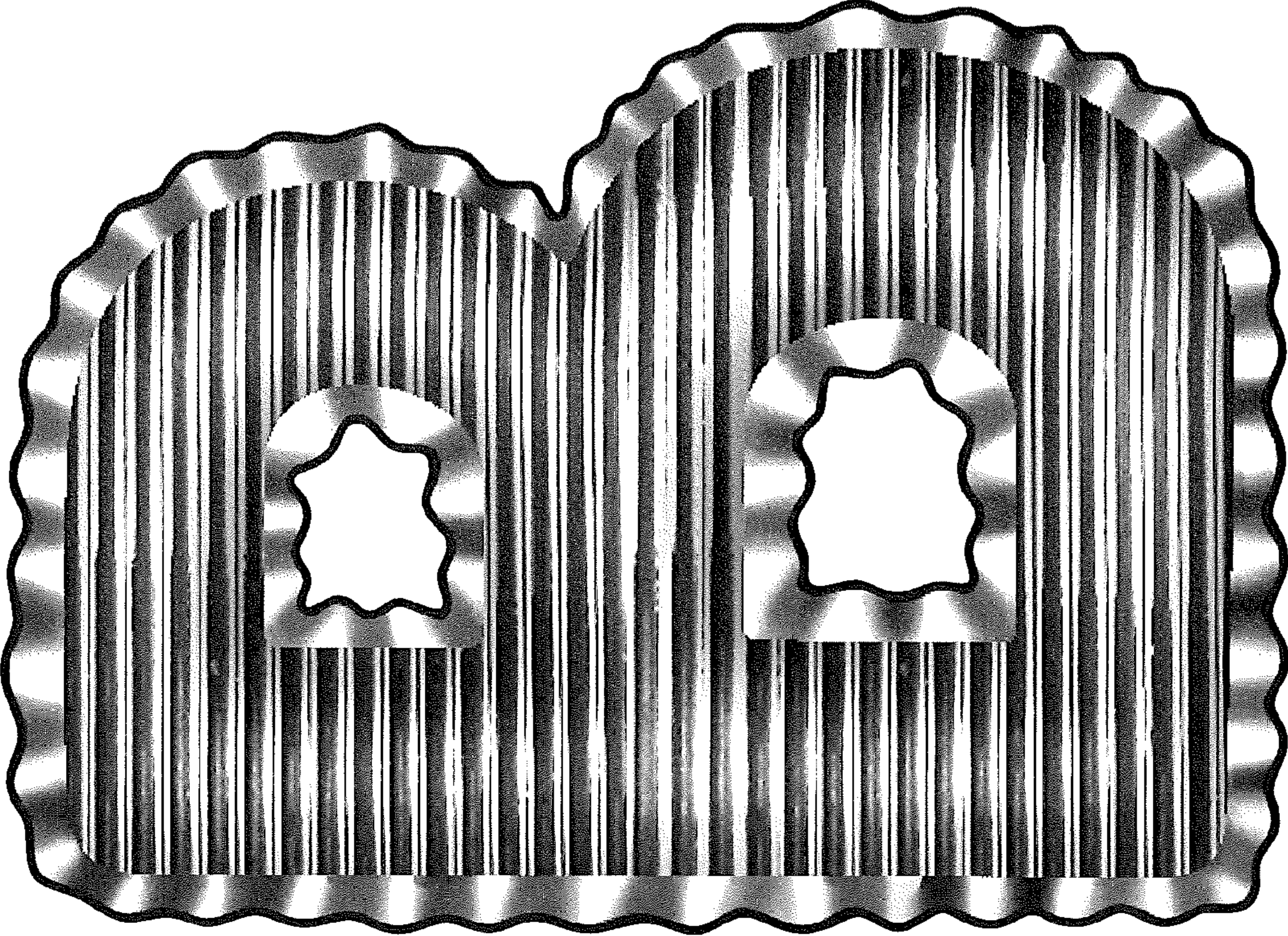

FIG. 3

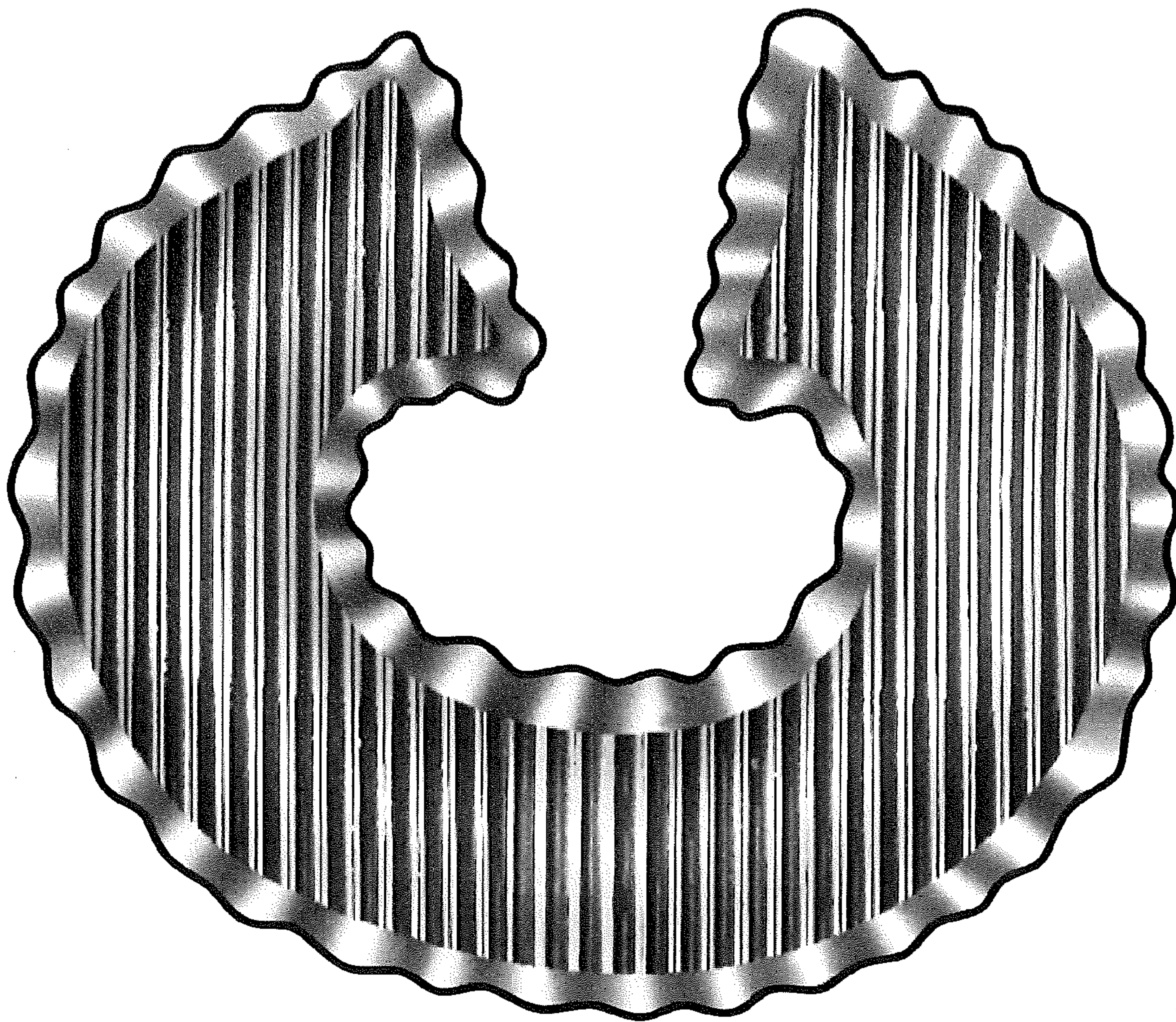

FIG. 4

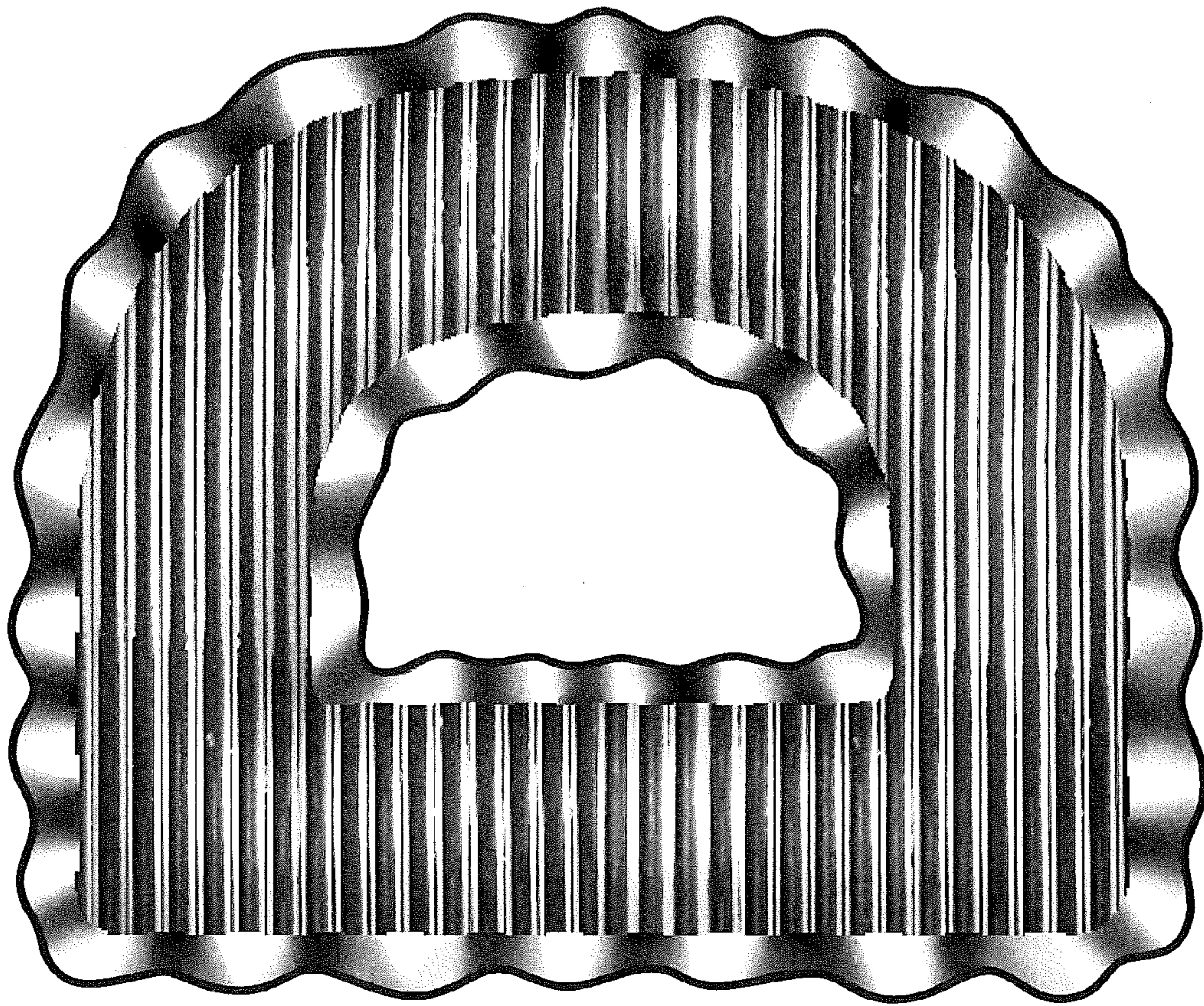

FIG. 5

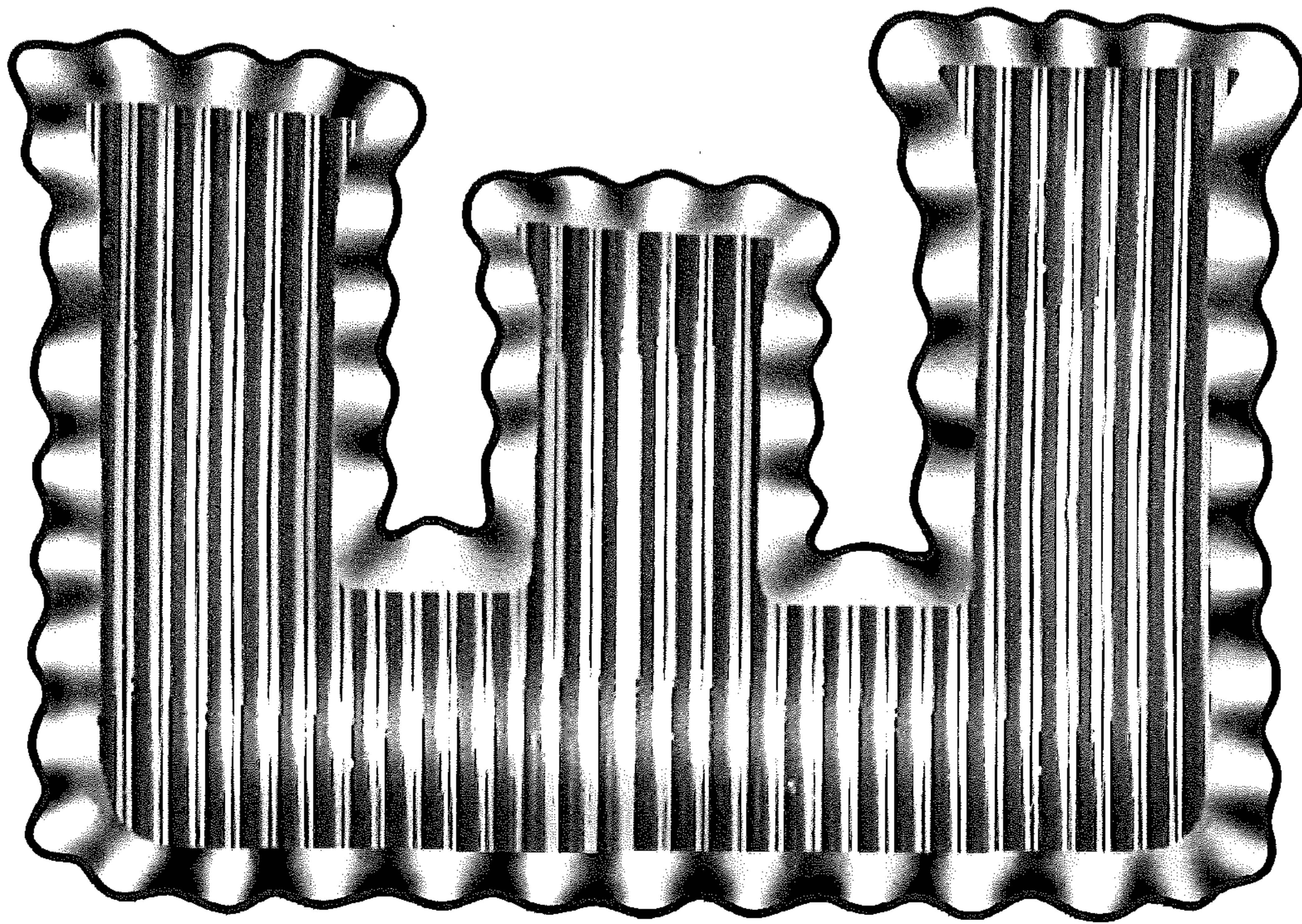

FIG. 6

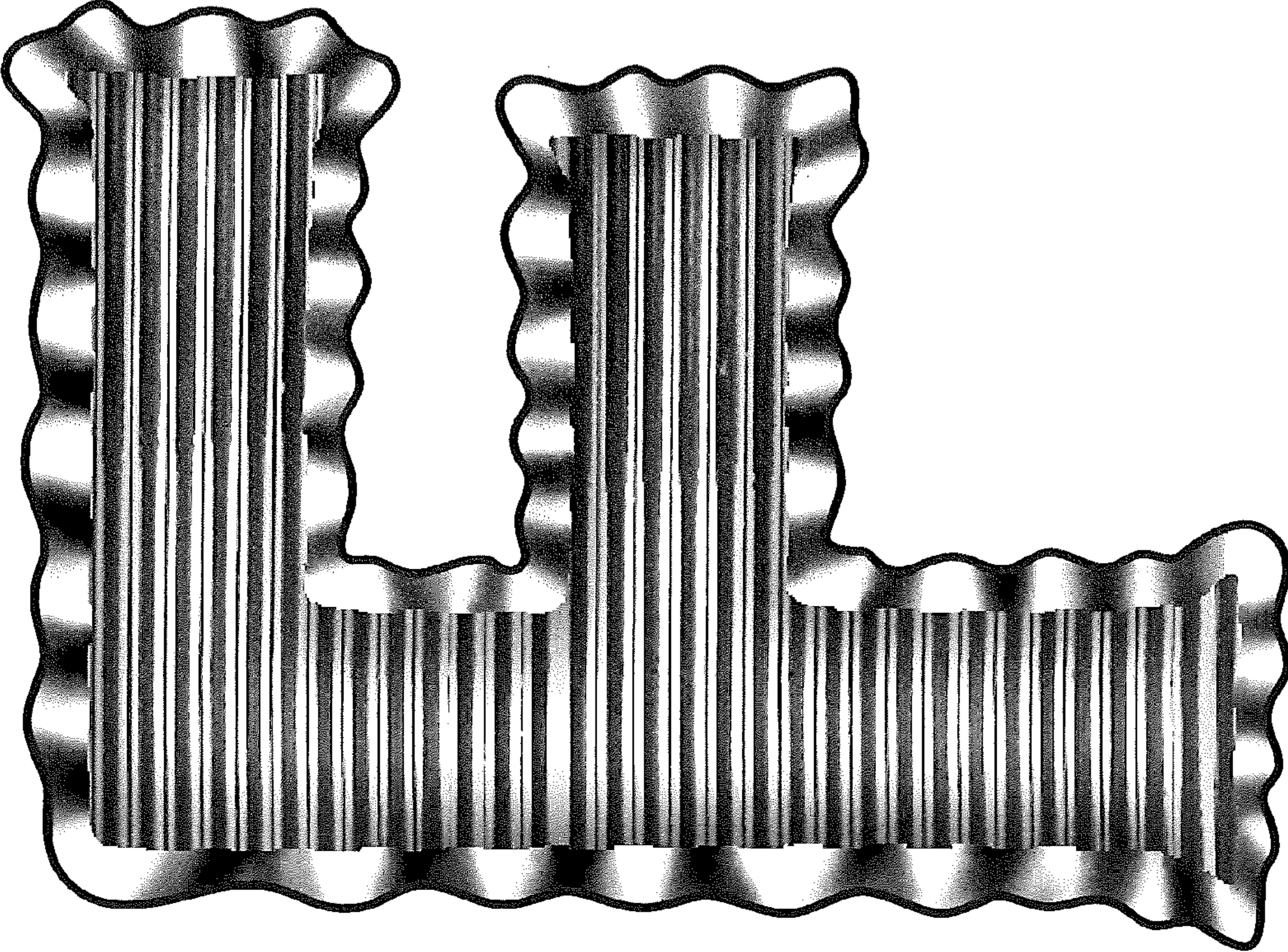

FIG. 7

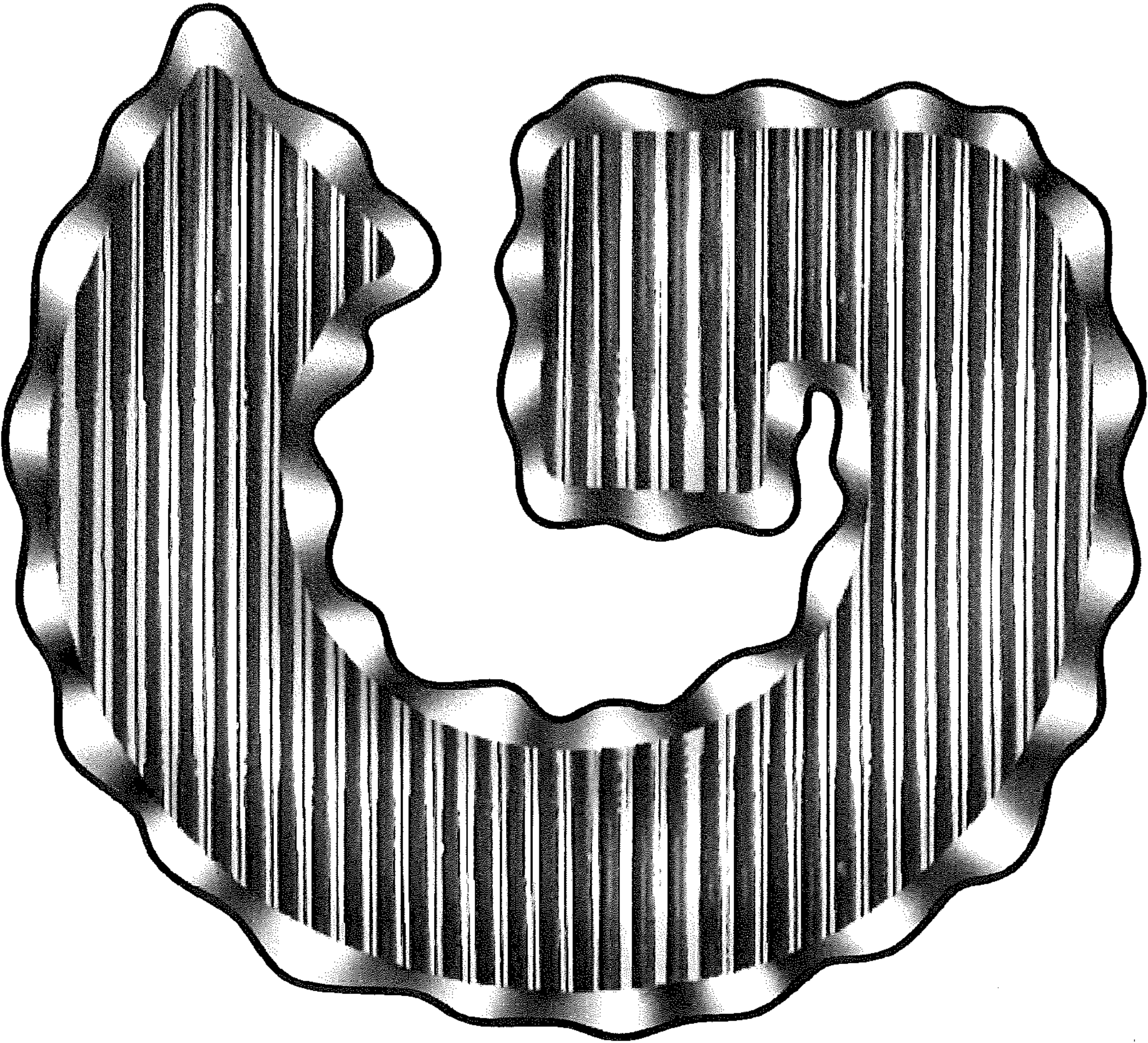

FIG. 8

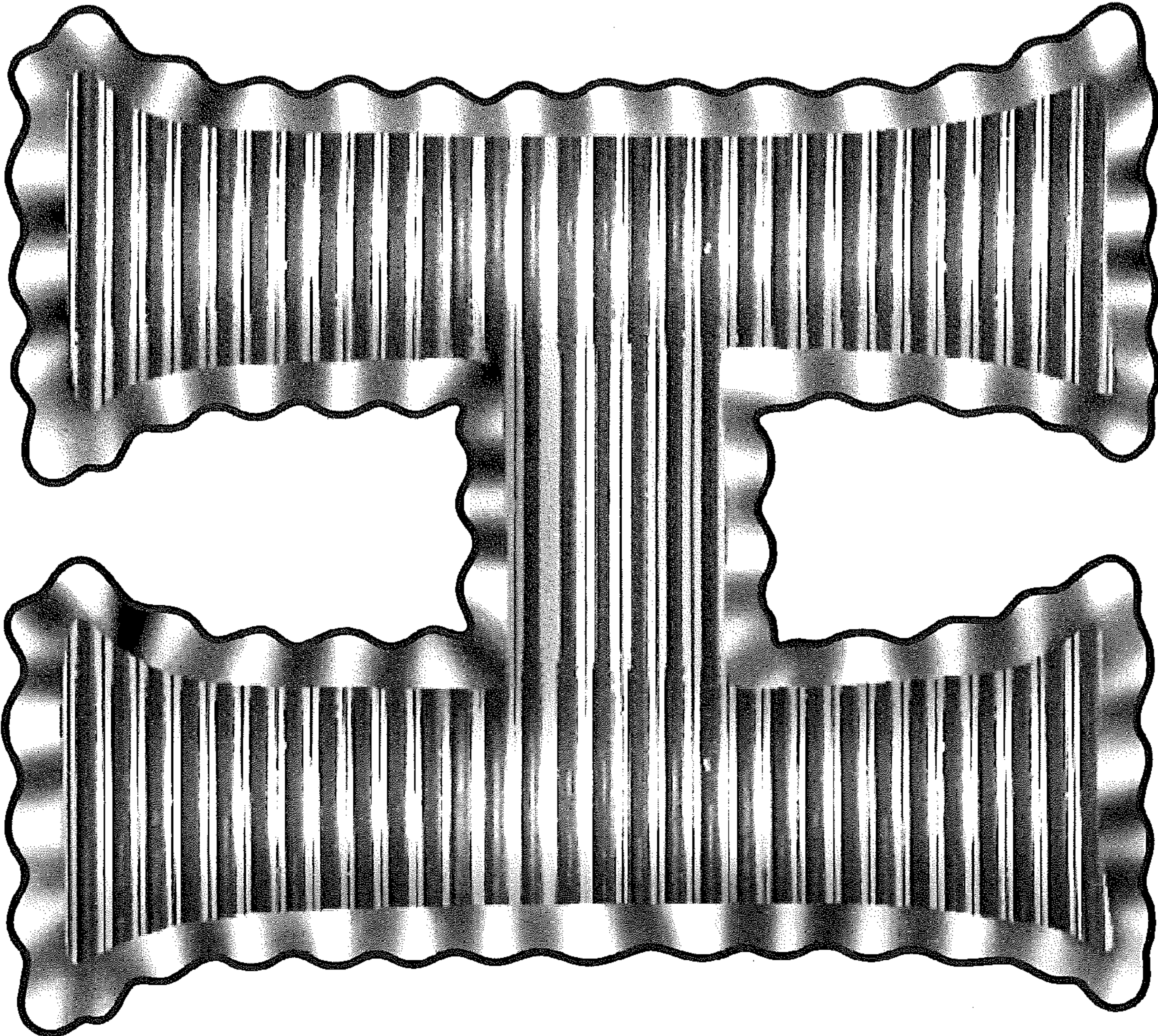

FIG. 9

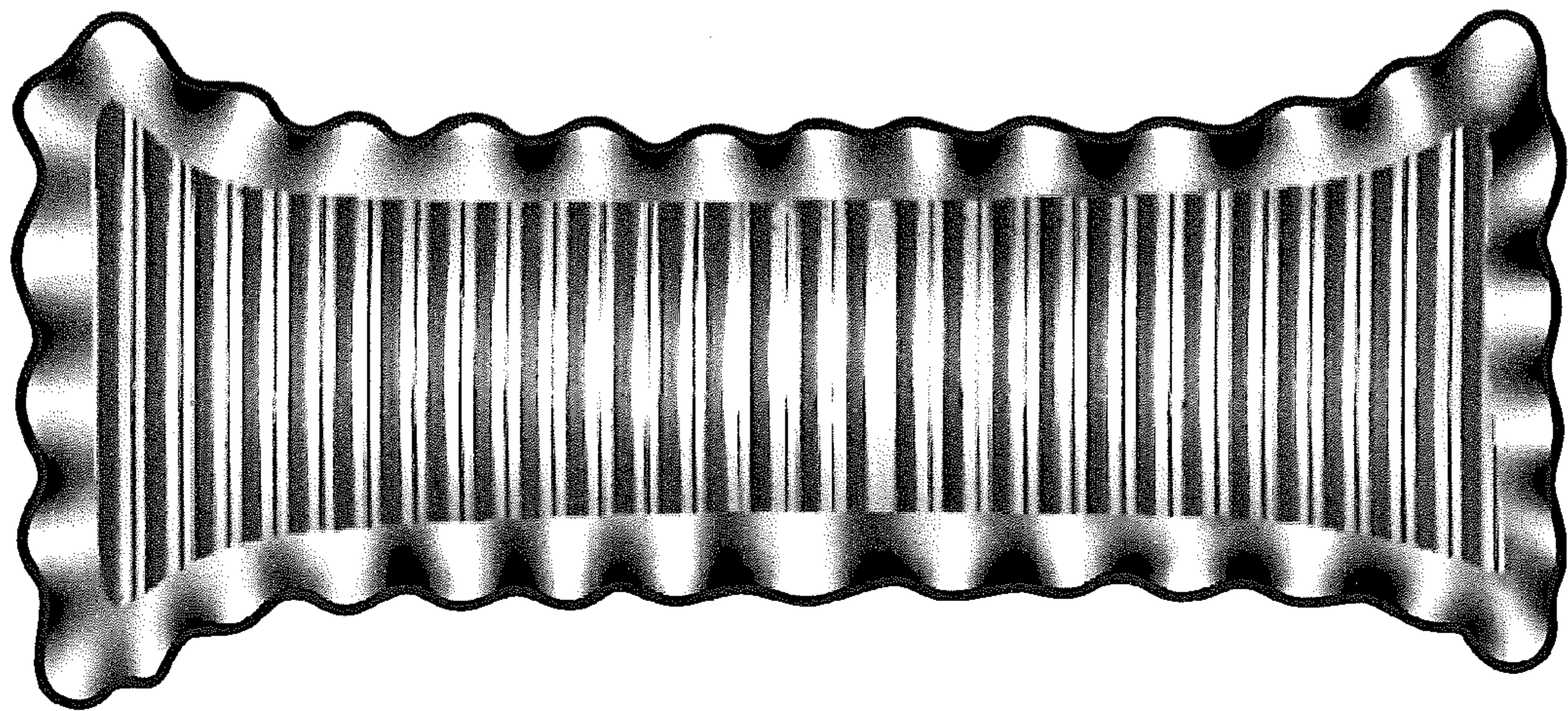

FIG. 10

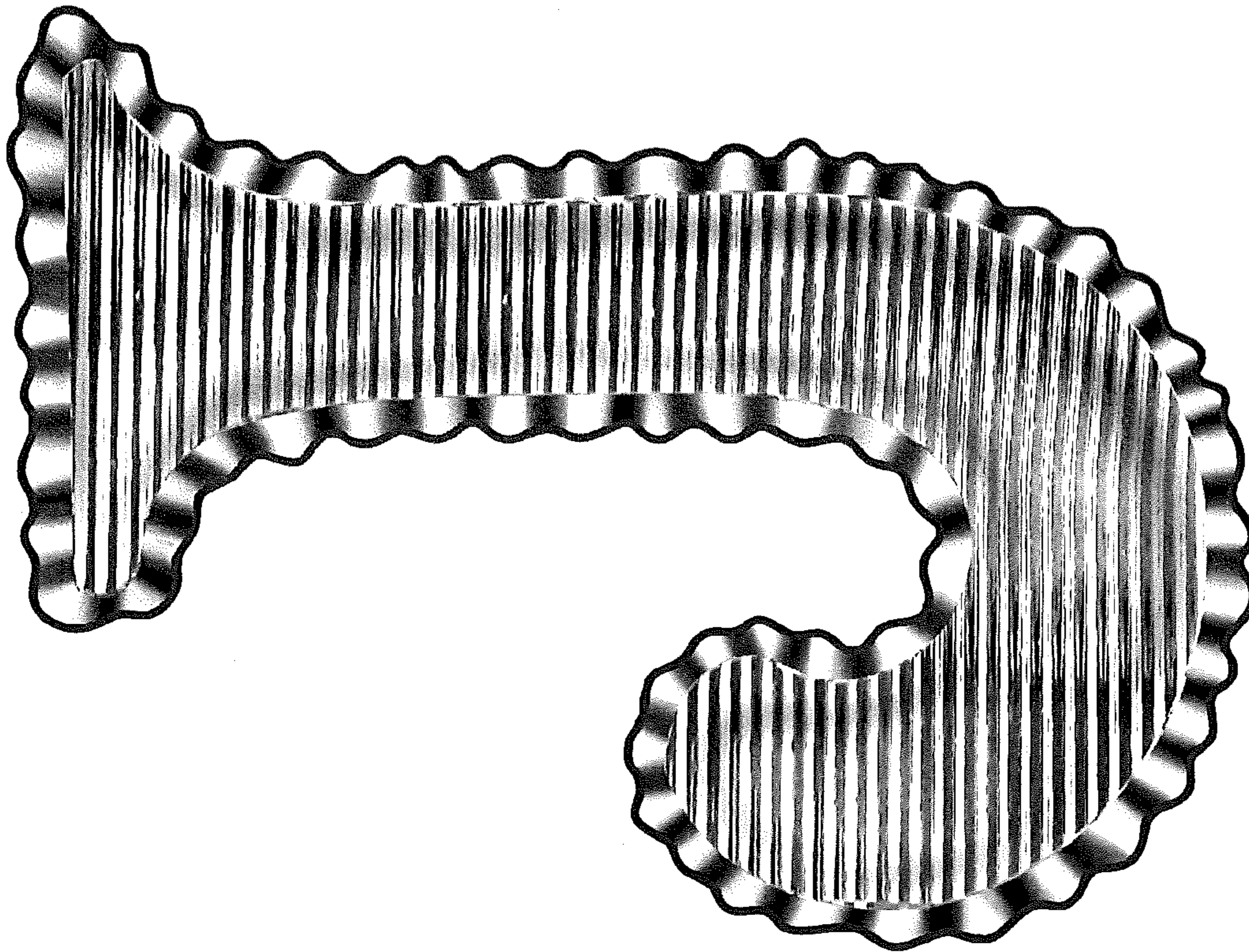

FIG. 11

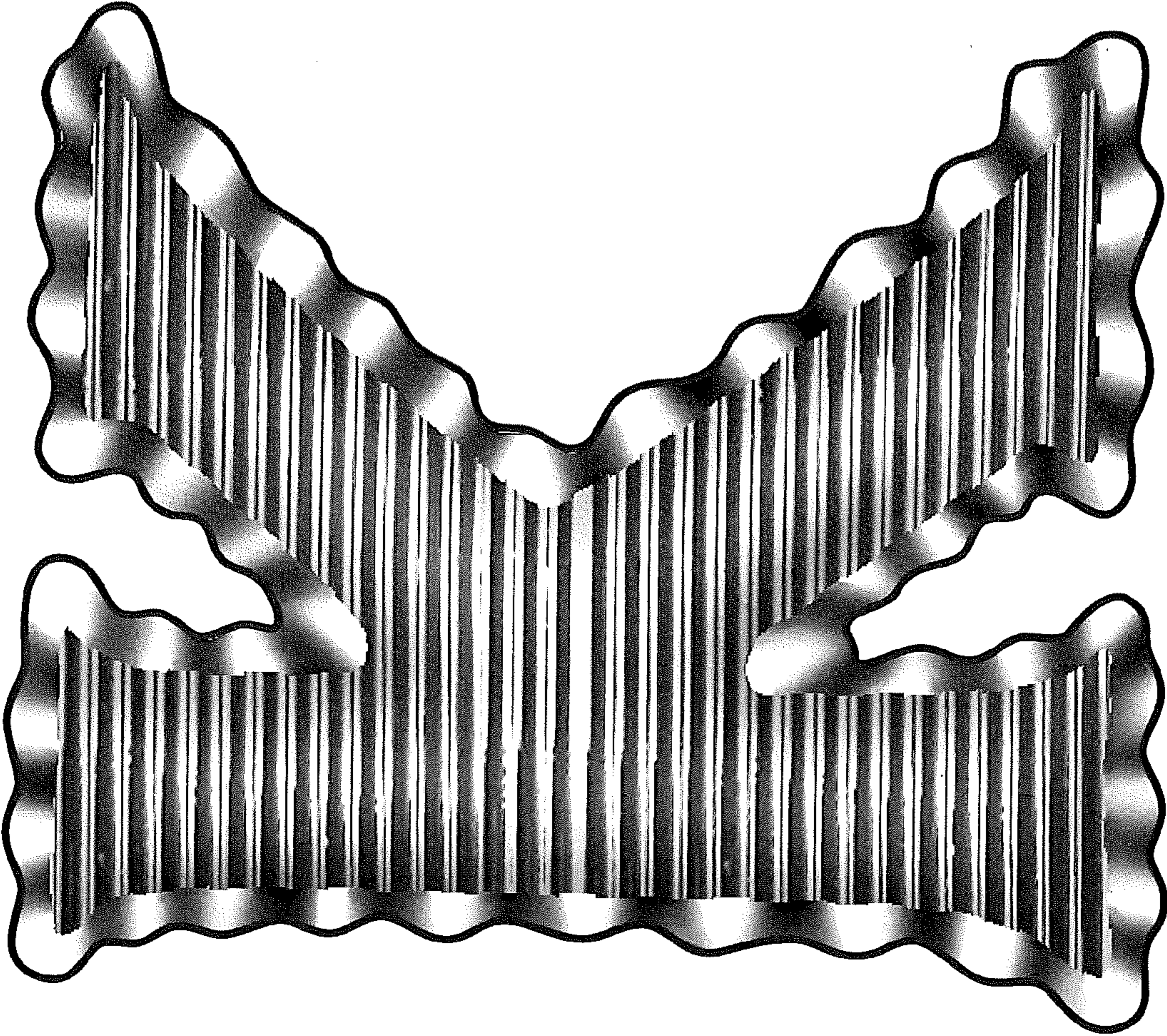

FIG. 12

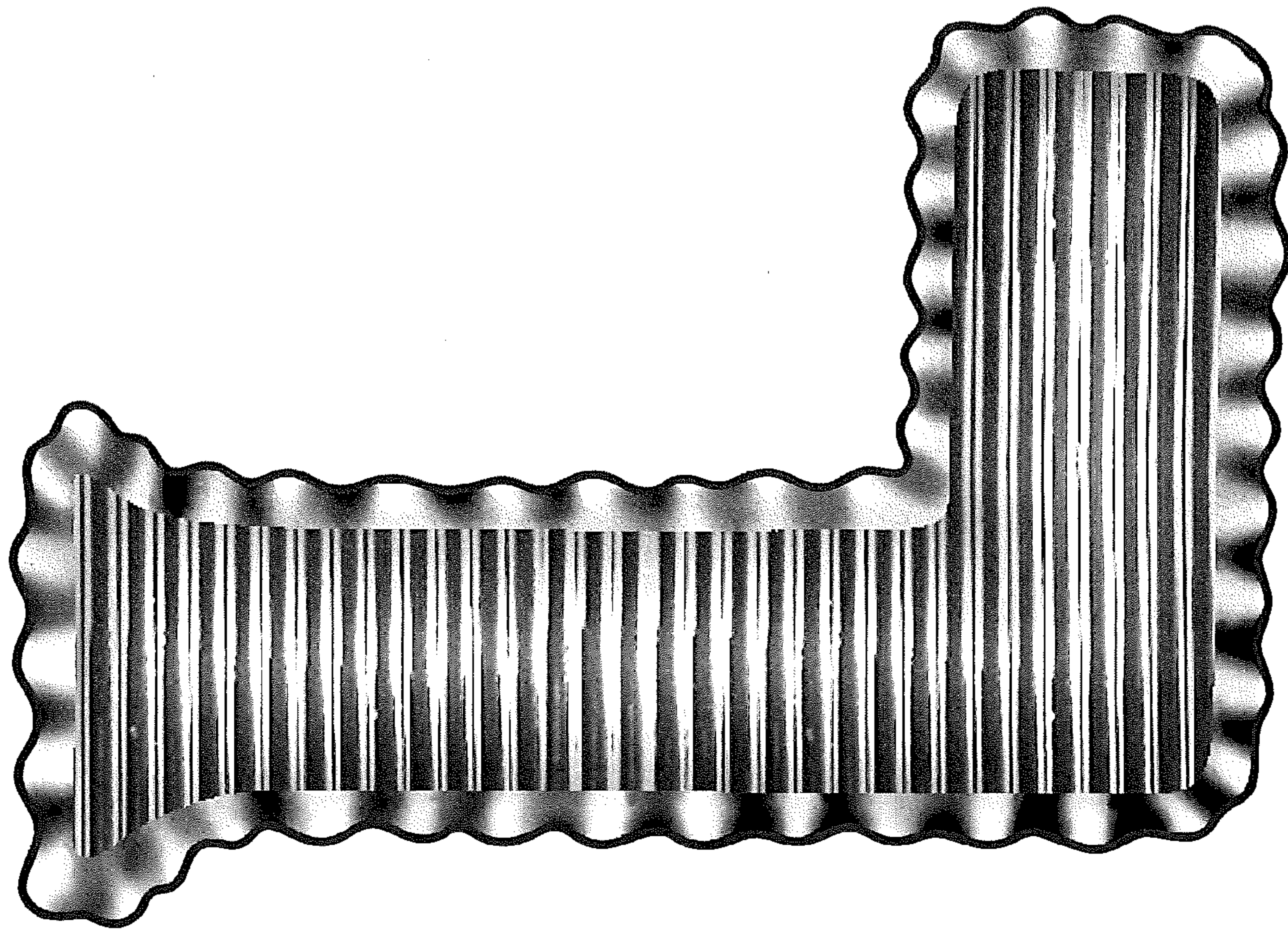

FIG. 13

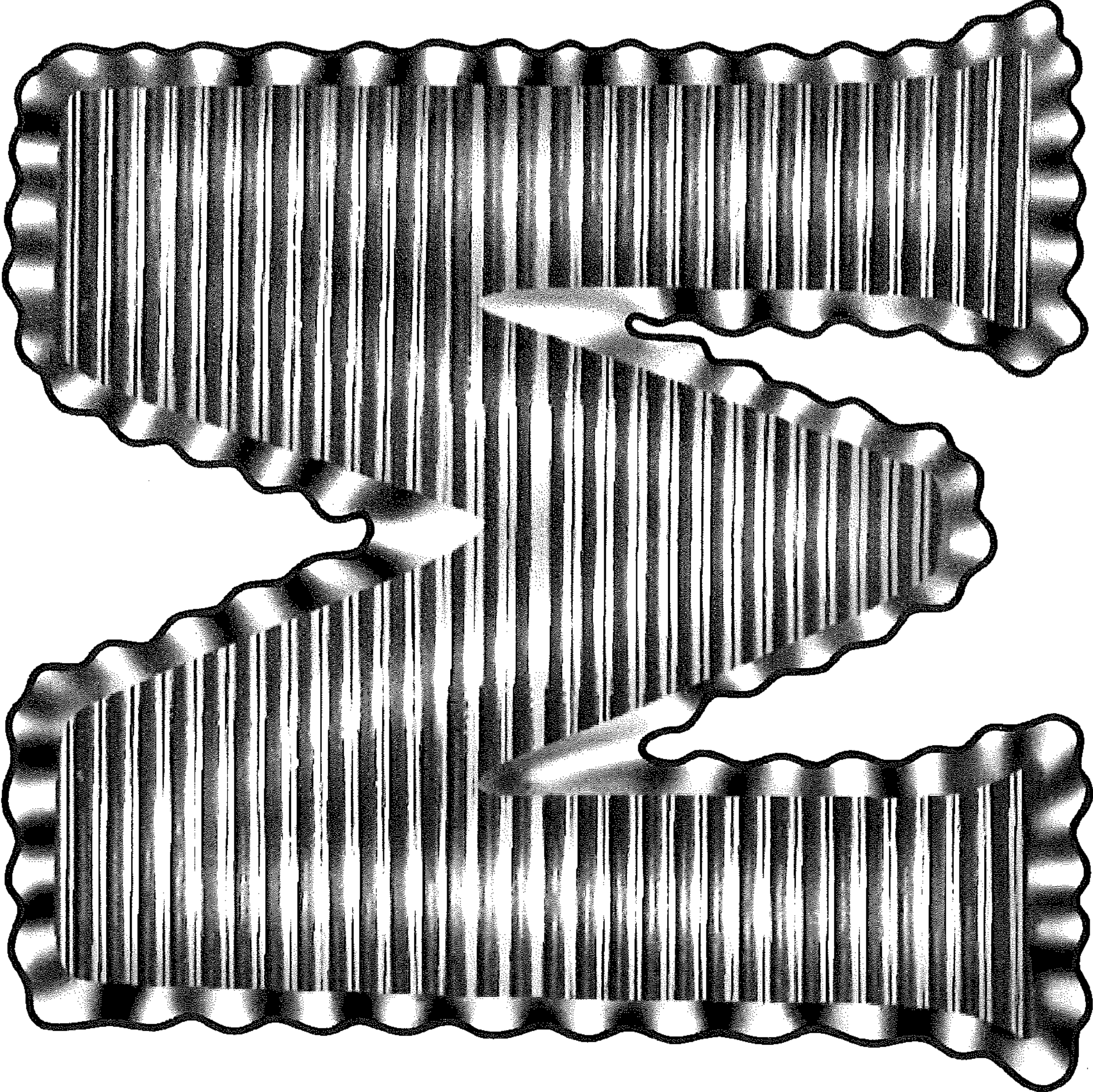

FIG. 14

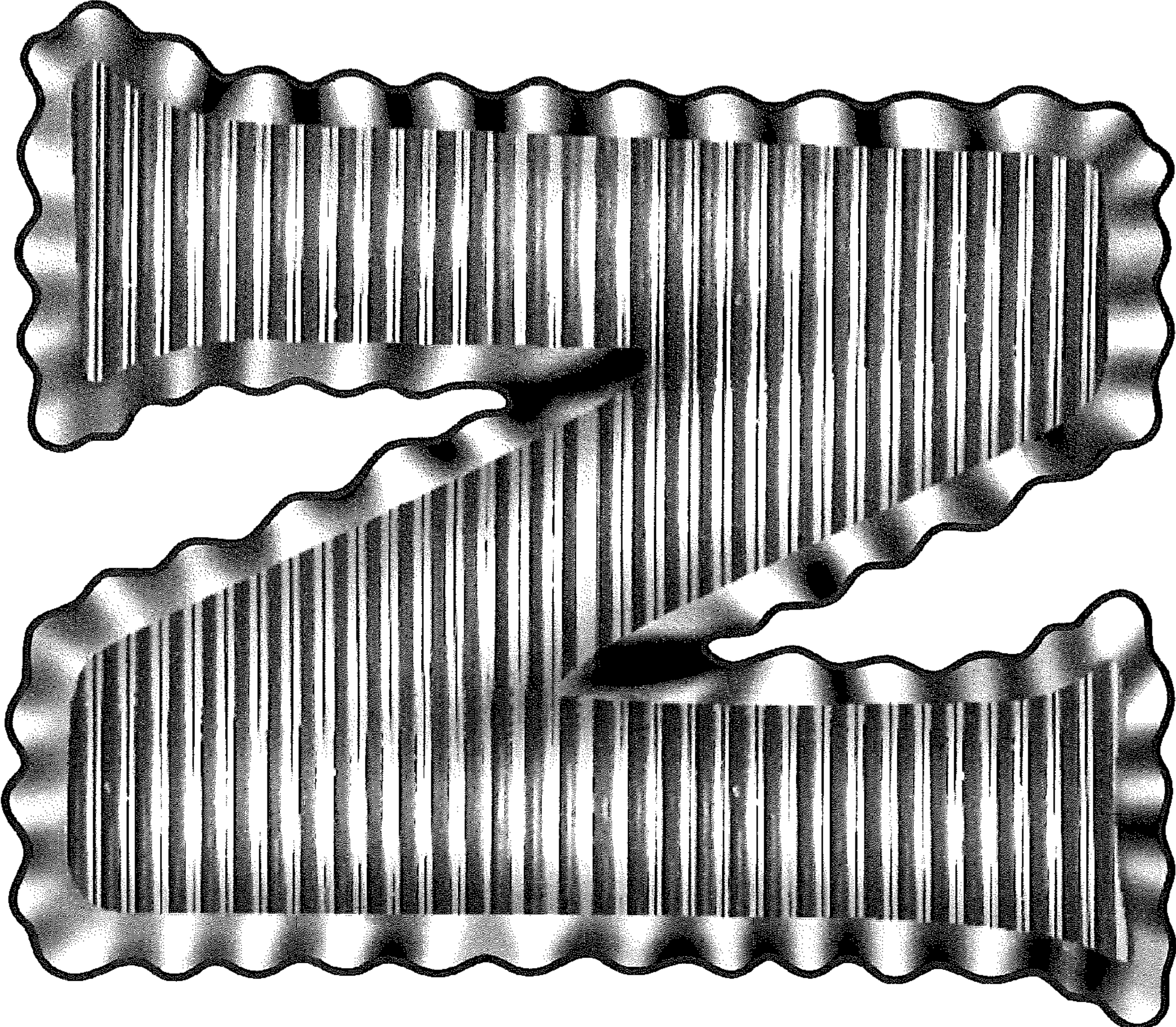

FIG. 15

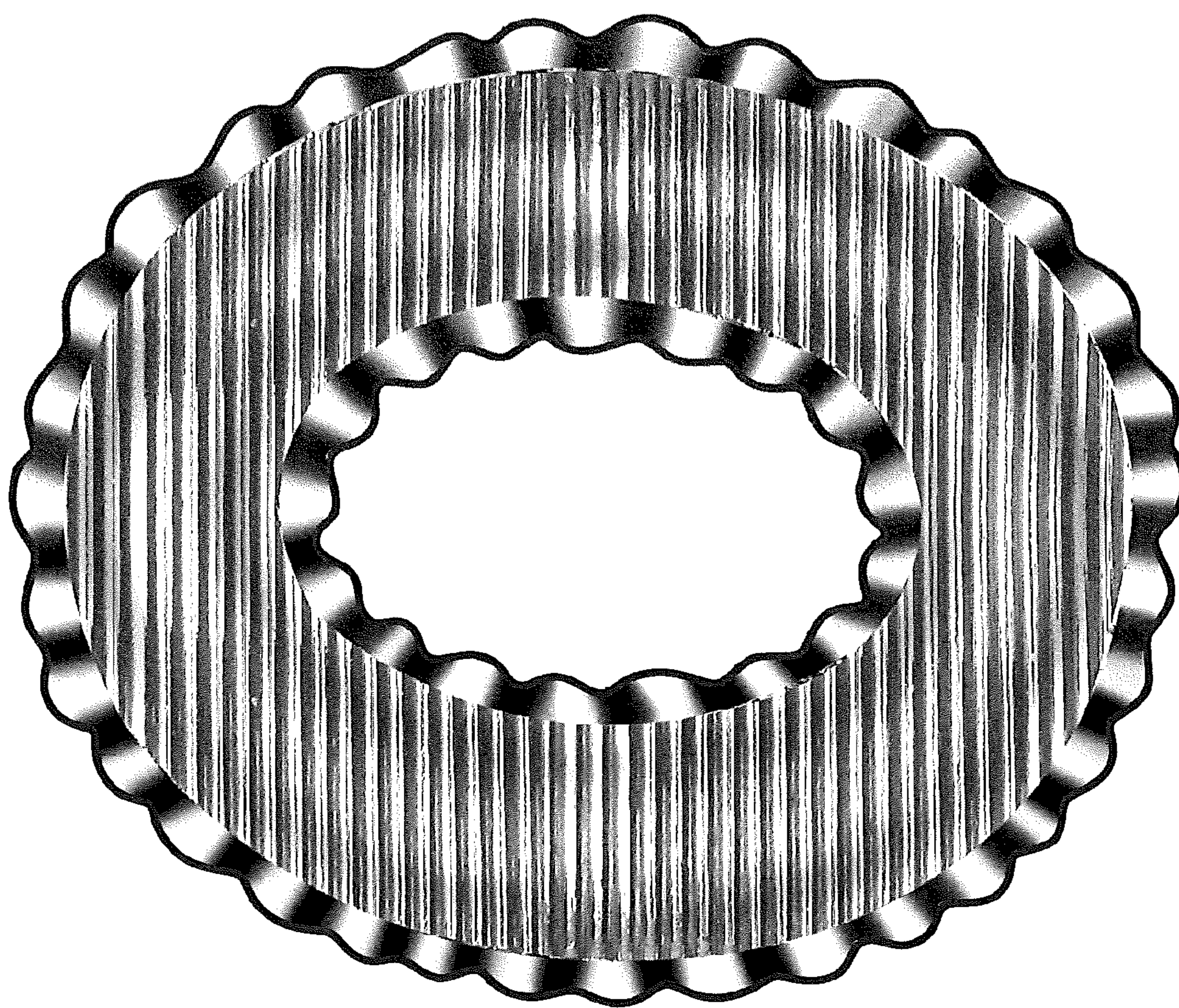

FIG. 16

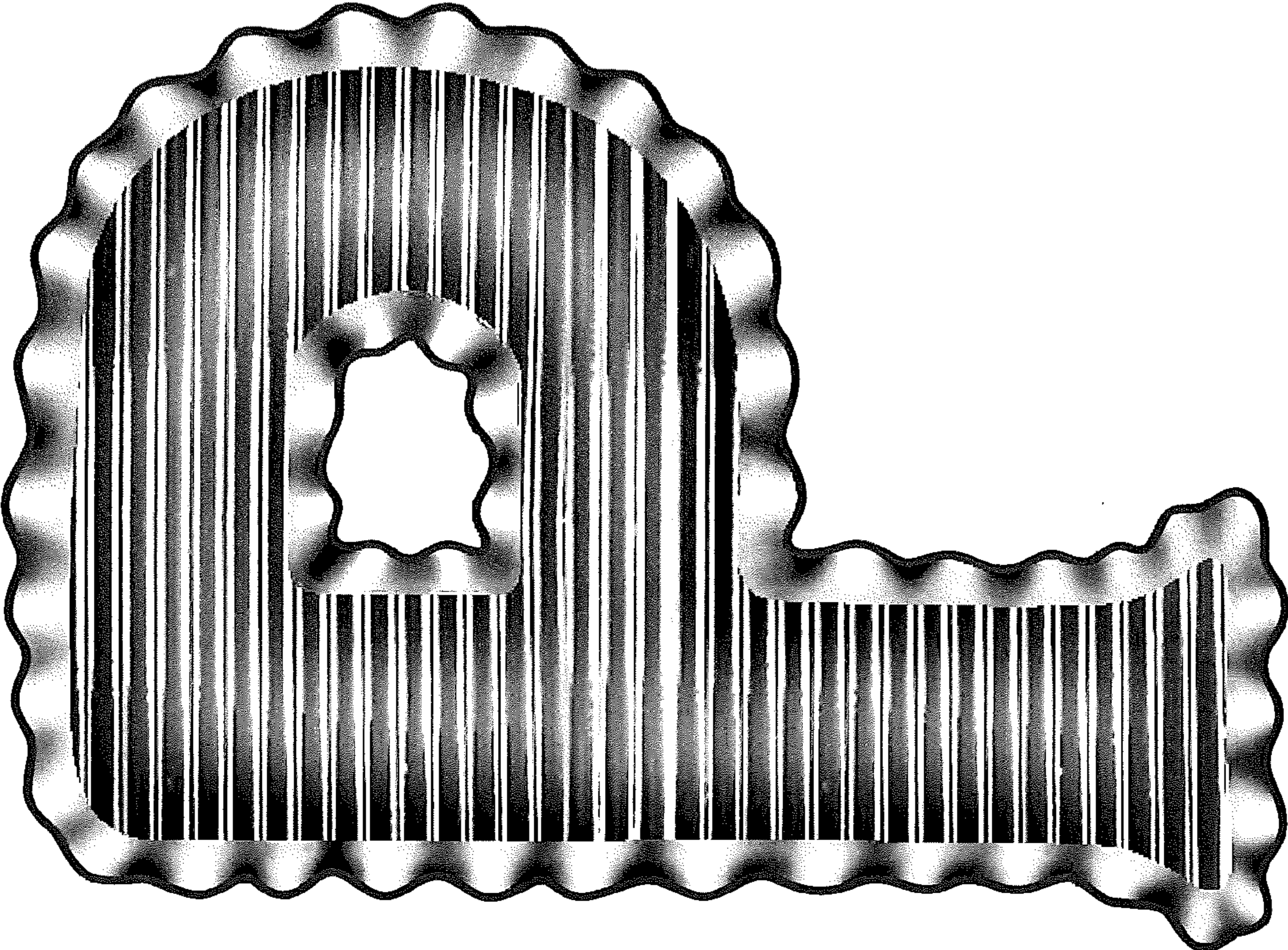

FIG. 17

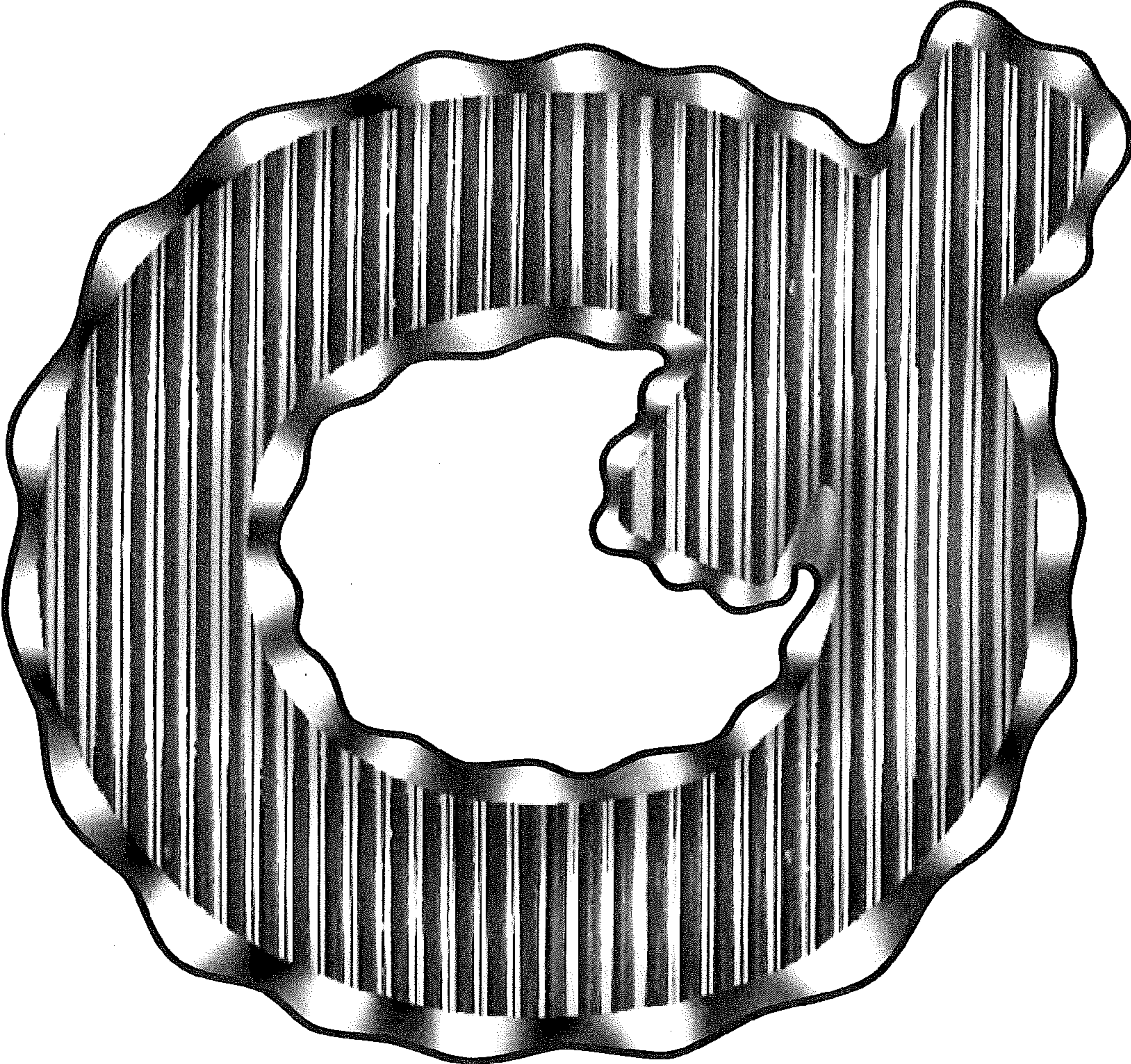

FIG. 18

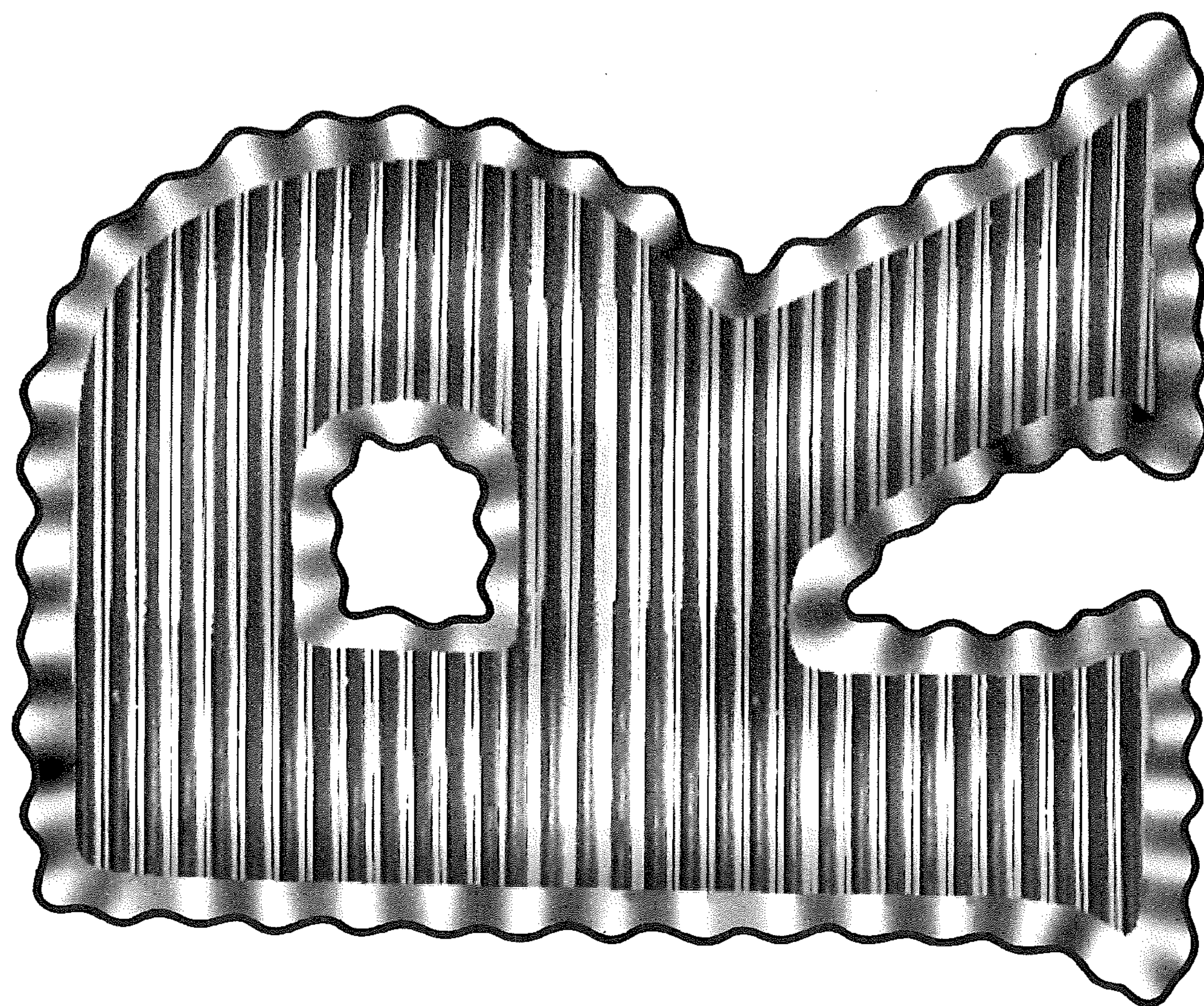

FIG. 19

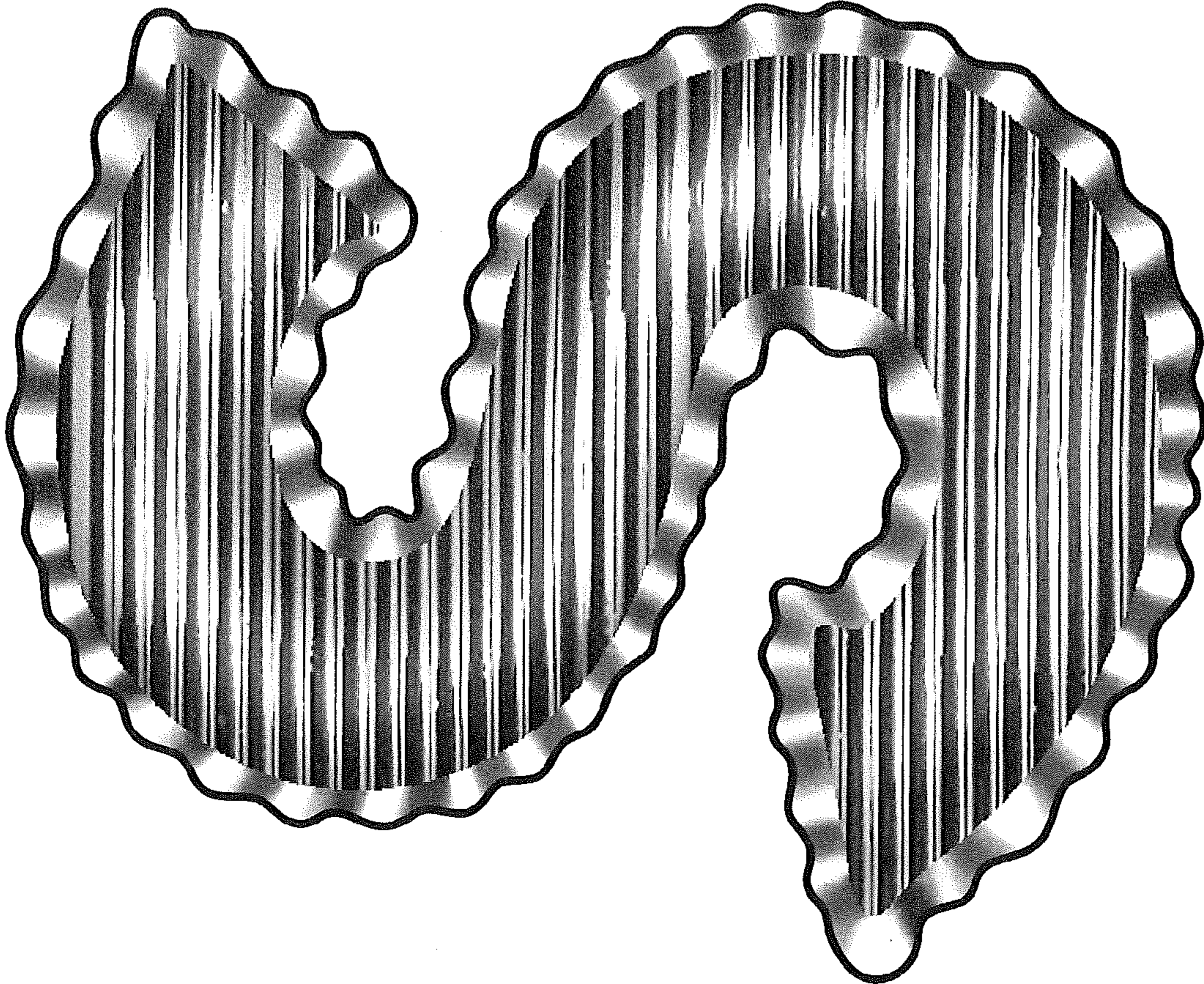

FIG. 20

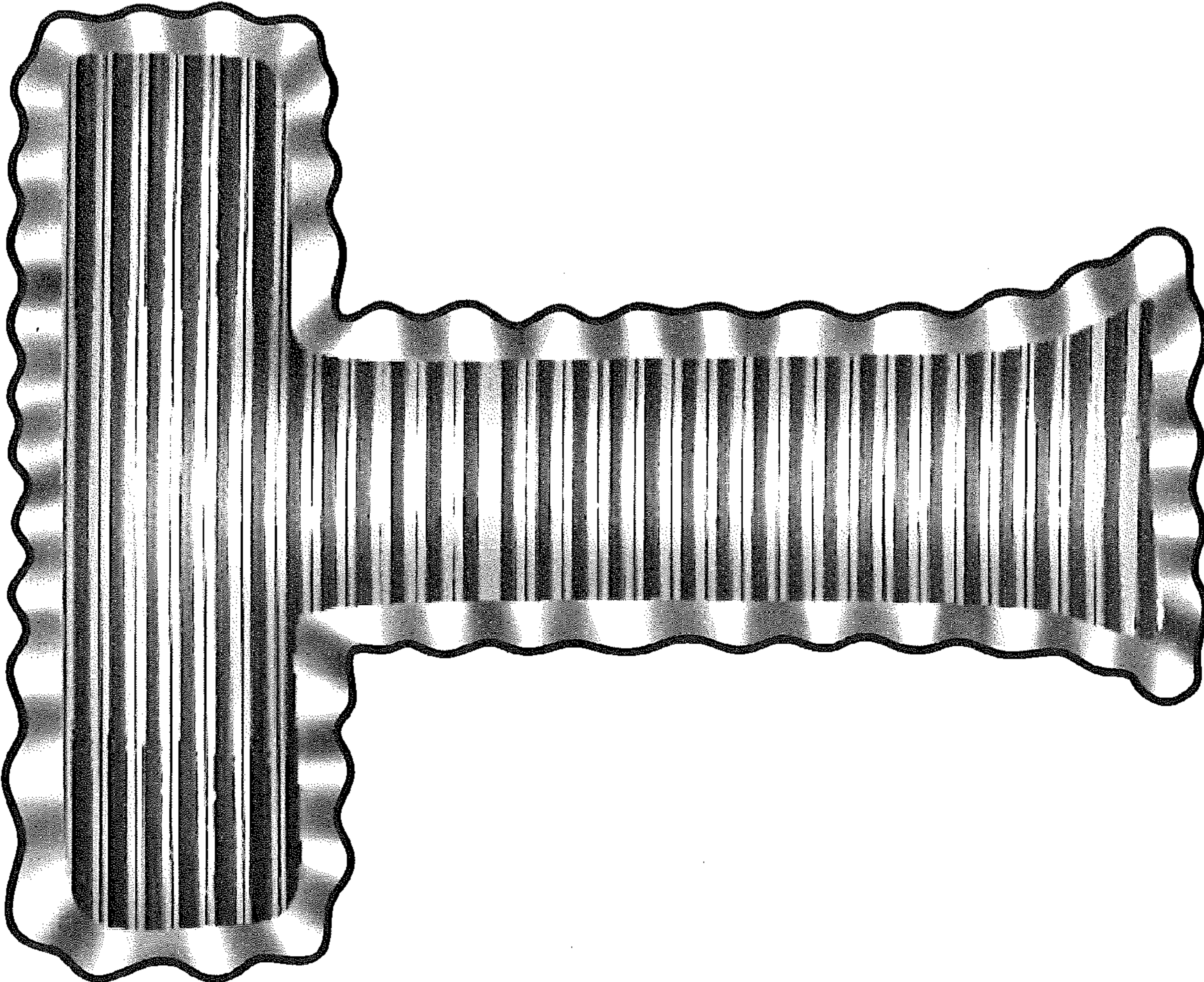

FIG. 21

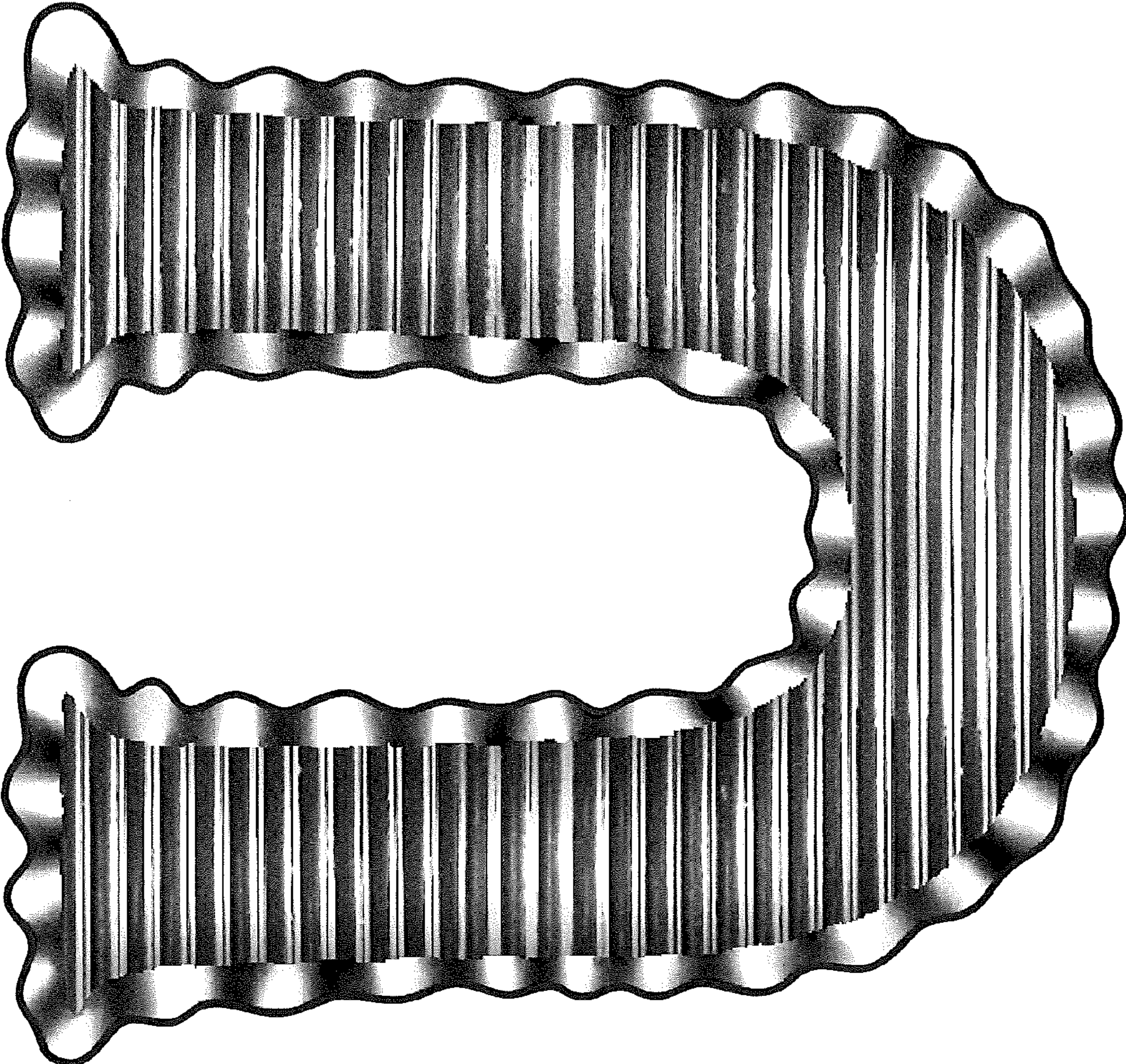

FIG. 22

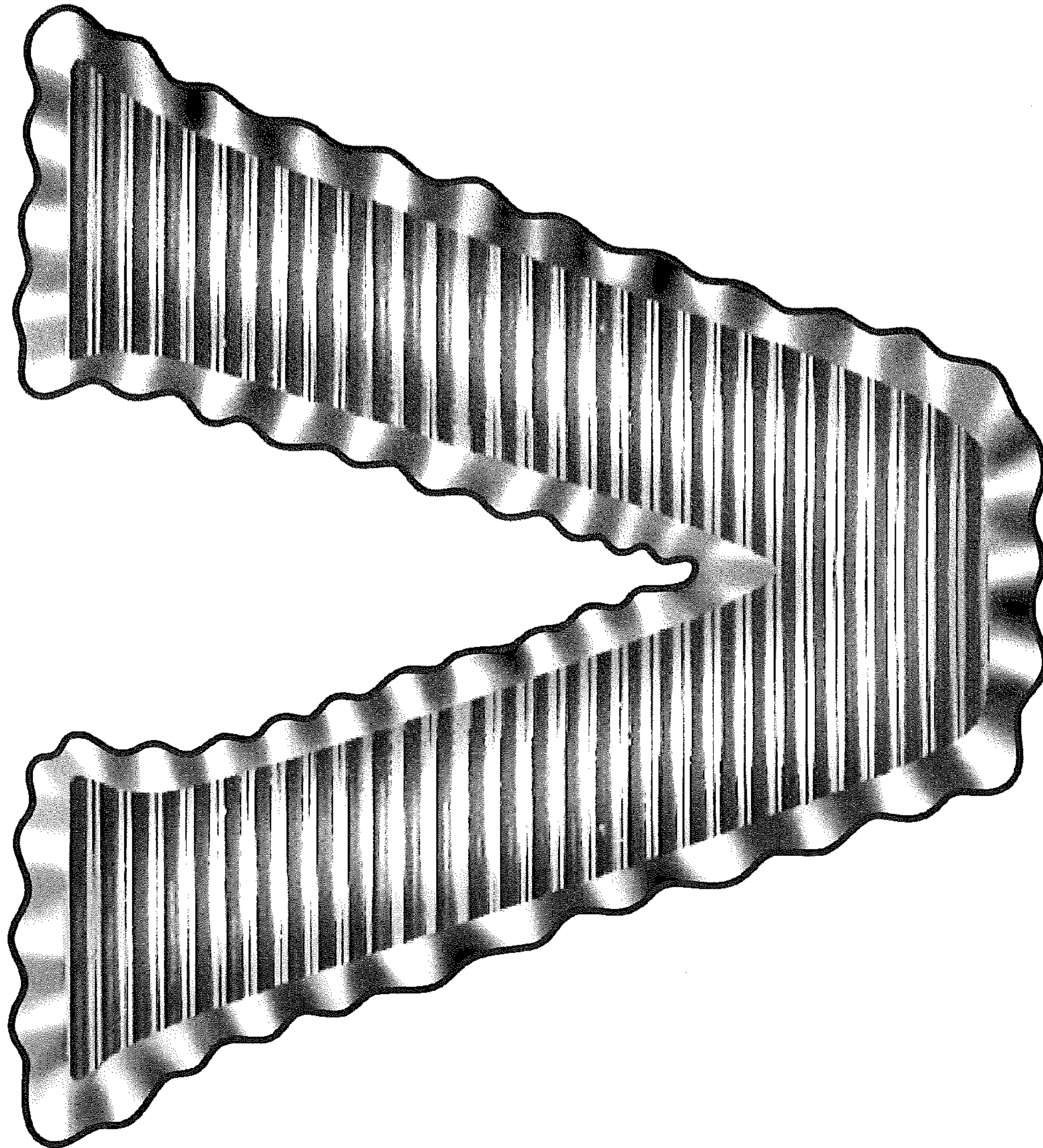

FIG. 23

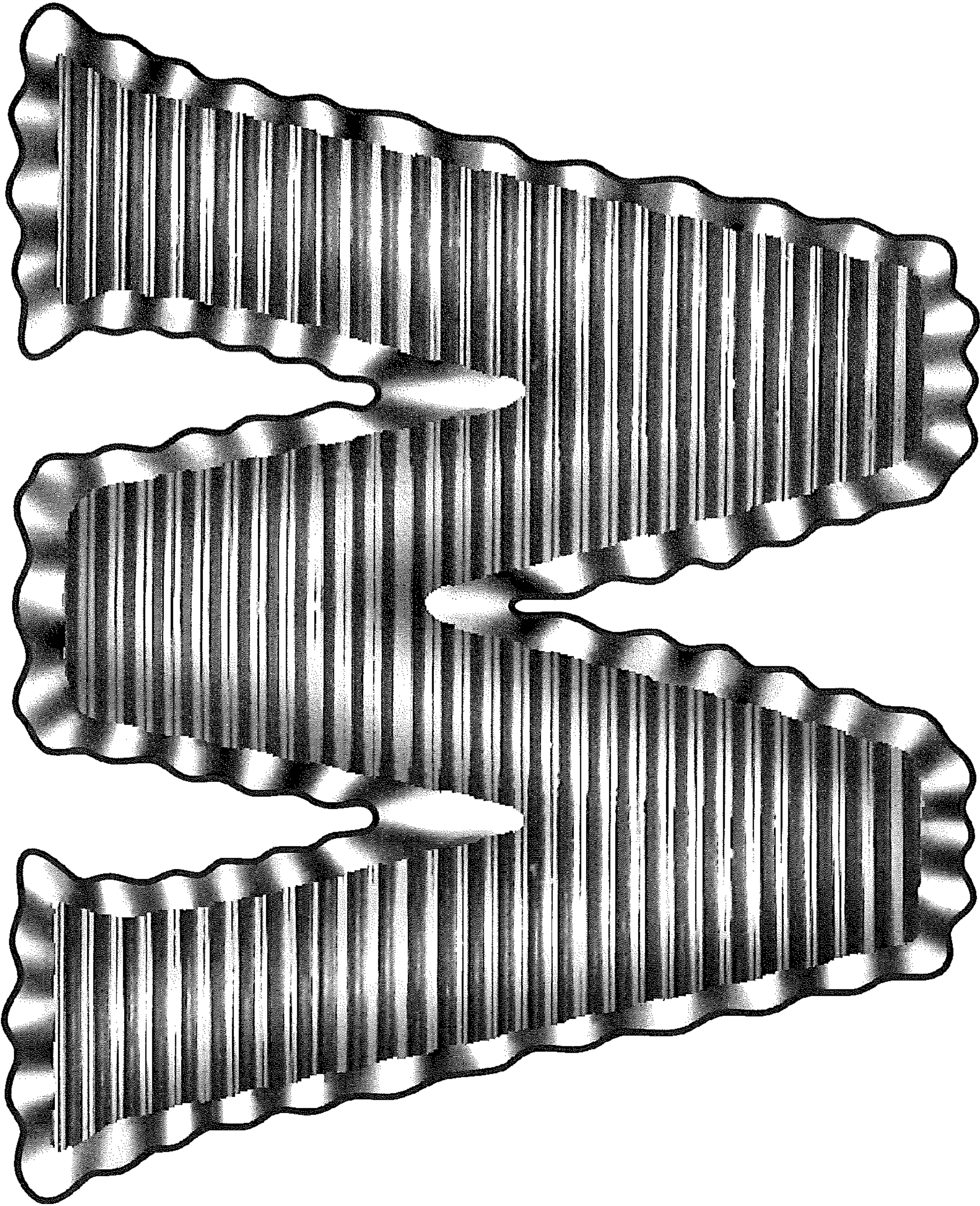

FIG. 24

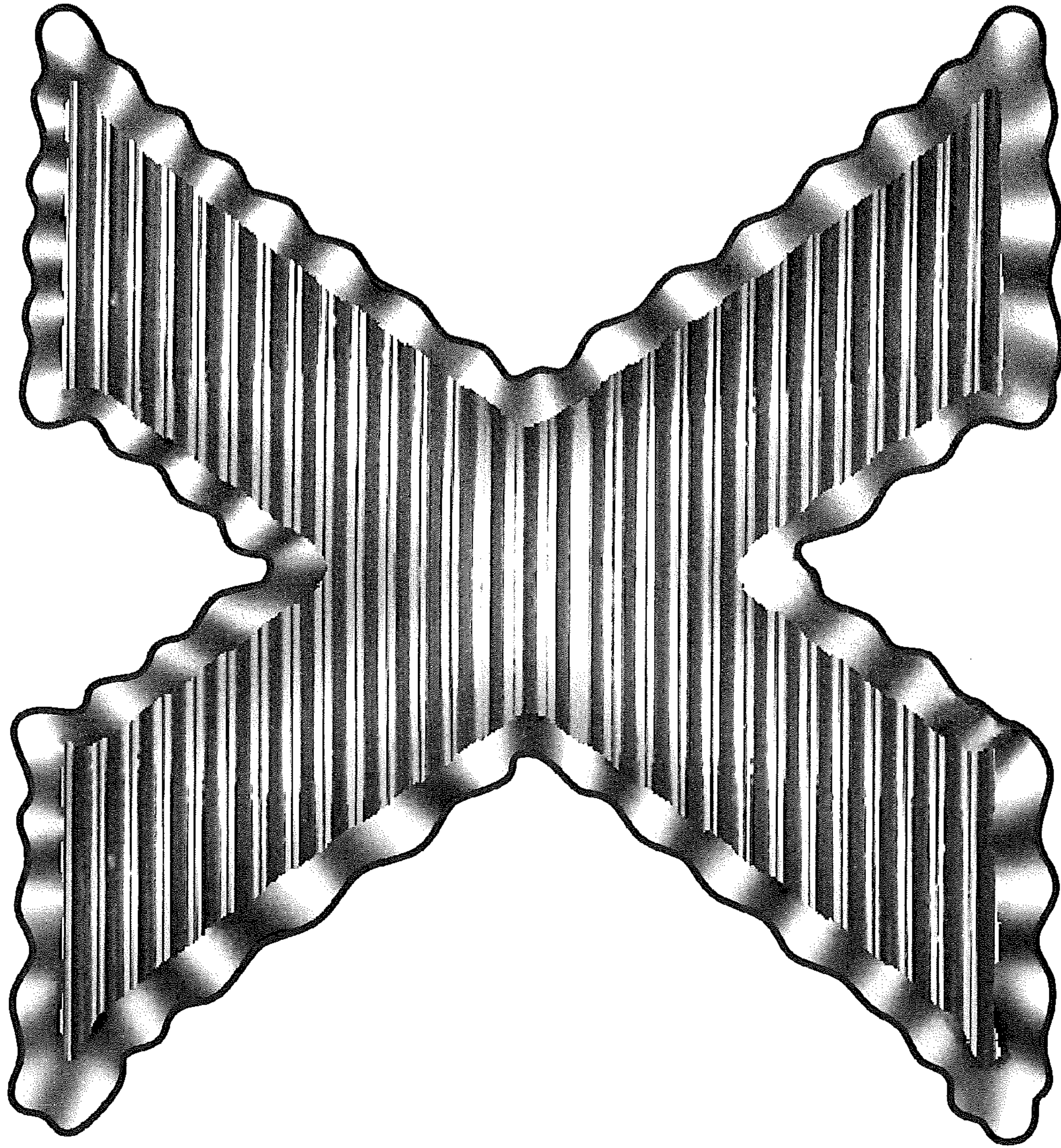

FIG. 25

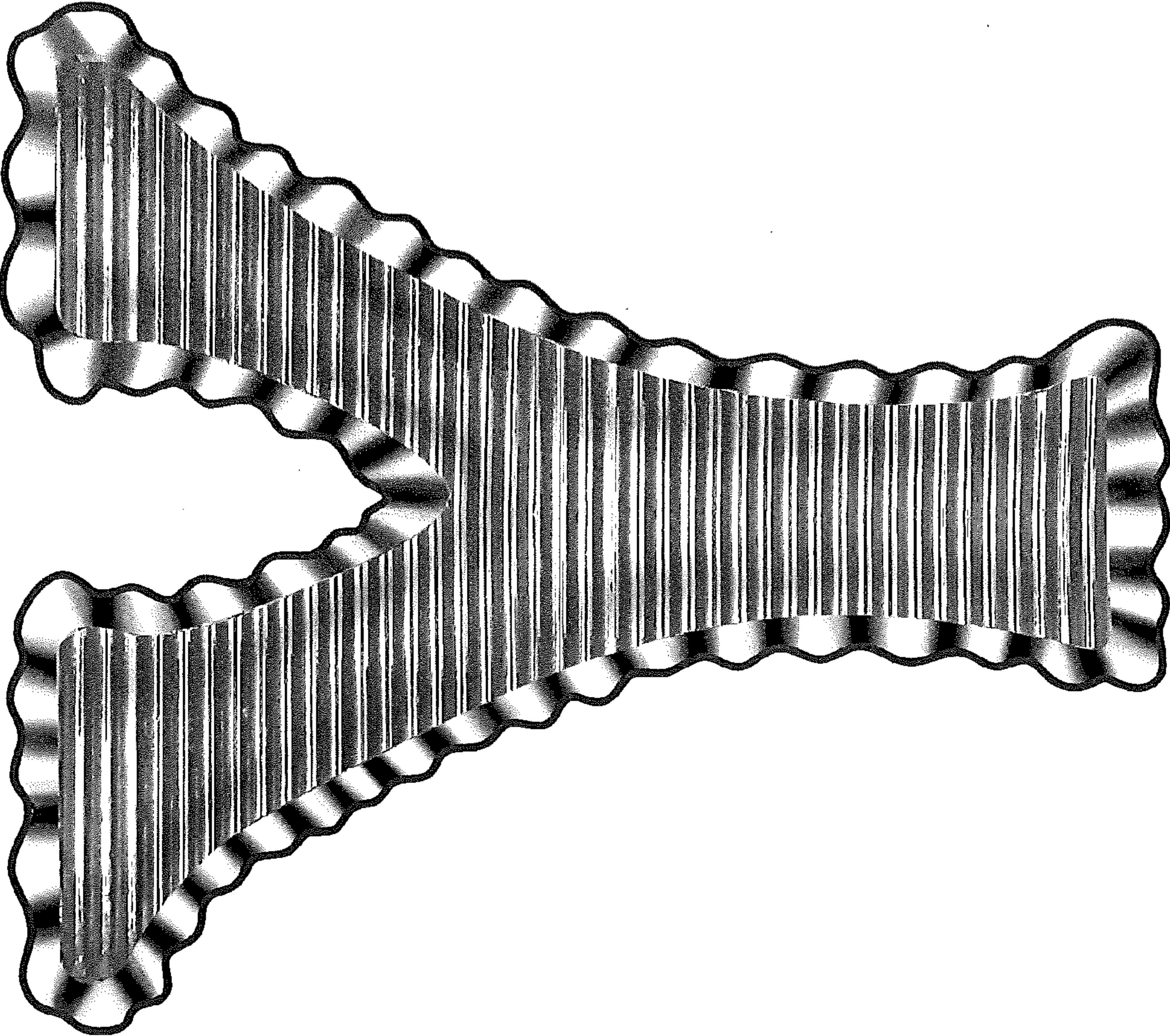

FIG. 26

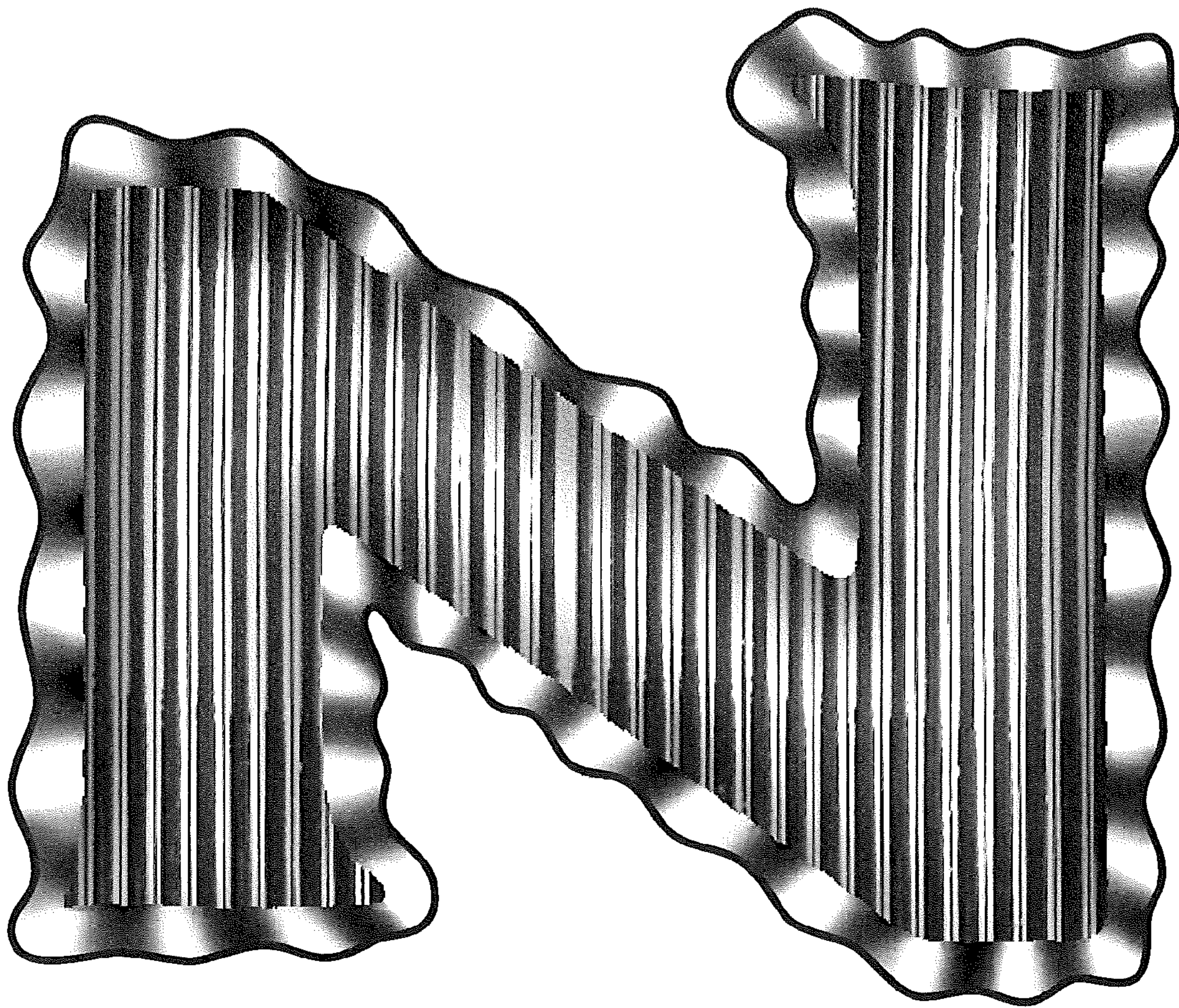

FIG. 27