



US00D647384S

(12) **United States Design Patent**
Dugan

(10) **Patent No.:** **US D647,384 S**

(45) **Date of Patent:** **** Oct. 25, 2011**

(54) **HINGED BENCH GRINDER SUPPORT**

(76) Inventor: **Charles E. Dugan**, Orange Park, FL
(US)

(**) Term: **14 Years**

(21) Appl. No.: **29/382,473**

(22) Filed: **Jan. 4, 2011**

(51) **LOC (9) Cl.** **08-06**

(52) **U.S. Cl.** **D8/323**

(58) **Field of Classification Search** D8/323,
D8/324, 330, 325, 327, 331, 336, 353, 338,
D8/356; D16/334; D10/69; D23/302, 303;
D3/905; 4/236, 240; 49/381; 248/682, 49,
248/68.1, 544, 73, 74.3; 33/347, 365-399;
174/153 G, 135, 72 A, 152 G; 5/503.1; 138/106;
24/16 PB, 545; 16/221, 226, 225, 230, 231,
16/234, 235, 251

See application file for complete search history.

(56) **References Cited**

U.S. PATENT DOCUMENTS

| | | | | |
|---------------|---------|----------------|-------|---------|
| D29,796 S * | 12/1898 | Lane | | D25/119 |
| D185,173 S * | 5/1959 | Roche | | D8/323 |
| 3,139,124 A | 6/1964 | Hoff | | |
| 3,421,458 A | 1/1969 | Salkoff et al. | | |
| 3,911,622 A * | 10/1975 | Prohaska | | 49/383 |
| D248,200 S * | 6/1978 | Stratton | | D6/300 |
| 4,375,775 A | 3/1983 | Franz | | |
| 5,873,433 A * | 2/1999 | Katz | | 182/129 |
| D409,077 S * | 5/1999 | Brooks | | D8/354 |

| | | | | |
|----------------|---------|--------------------|-------|--------|
| D462,841 S * | 9/2002 | Wilson | | D6/300 |
| 6,443,260 B1 | 9/2002 | Katz et al. | | |
| D480,191 S * | 9/2003 | Glaser | | D32/54 |
| 6,662,838 B1 | 12/2003 | Graham, III | | |
| D624,387 S * | 9/2010 | Charette | | D8/323 |
| D638,638 S * | 5/2011 | Fitzpatrick et al. | | D6/429 |
| 7,945,995 B1 * | 5/2011 | Gates | | 16/226 |

* cited by examiner

Primary Examiner — Cynthia Underwood

(74) *Attorney, Agent, or Firm* — Crossley Patent Law; Mark A. Crossley

(57) **CLAIM**

The ornamental design for a hinged bench grinder support, as shown and described.

DESCRIPTION

FIG. 1 is a front elevation view of a hinged bench grinder support showing my new design with an upper portion and lower portion separated for clarity; FIG. 2 is a rear elevation view thereof; FIG. 3 is a right elevation view thereof, the opposite side being a mirror image of the shown; FIG. 4 is a top plan view thereof; FIG. 5 is a bottom plan view thereof; and, FIG. 6 is an isometric view of the hinged bench grinder support shown in an environment of use. The broken lines in the drawings depict environmental subject matter only and form no part of the claimed design.

1 Claim, 5 Drawing Sheets



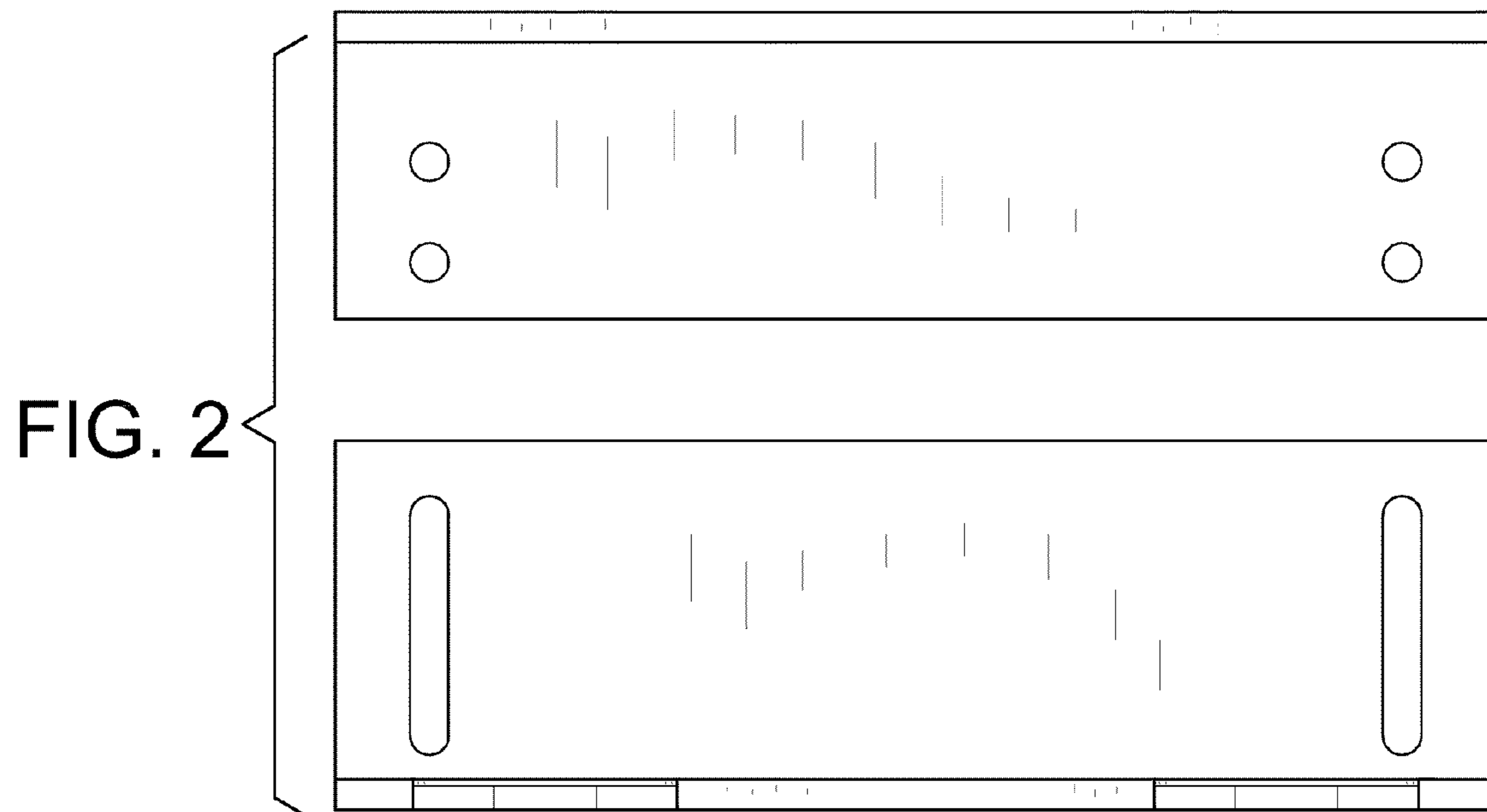
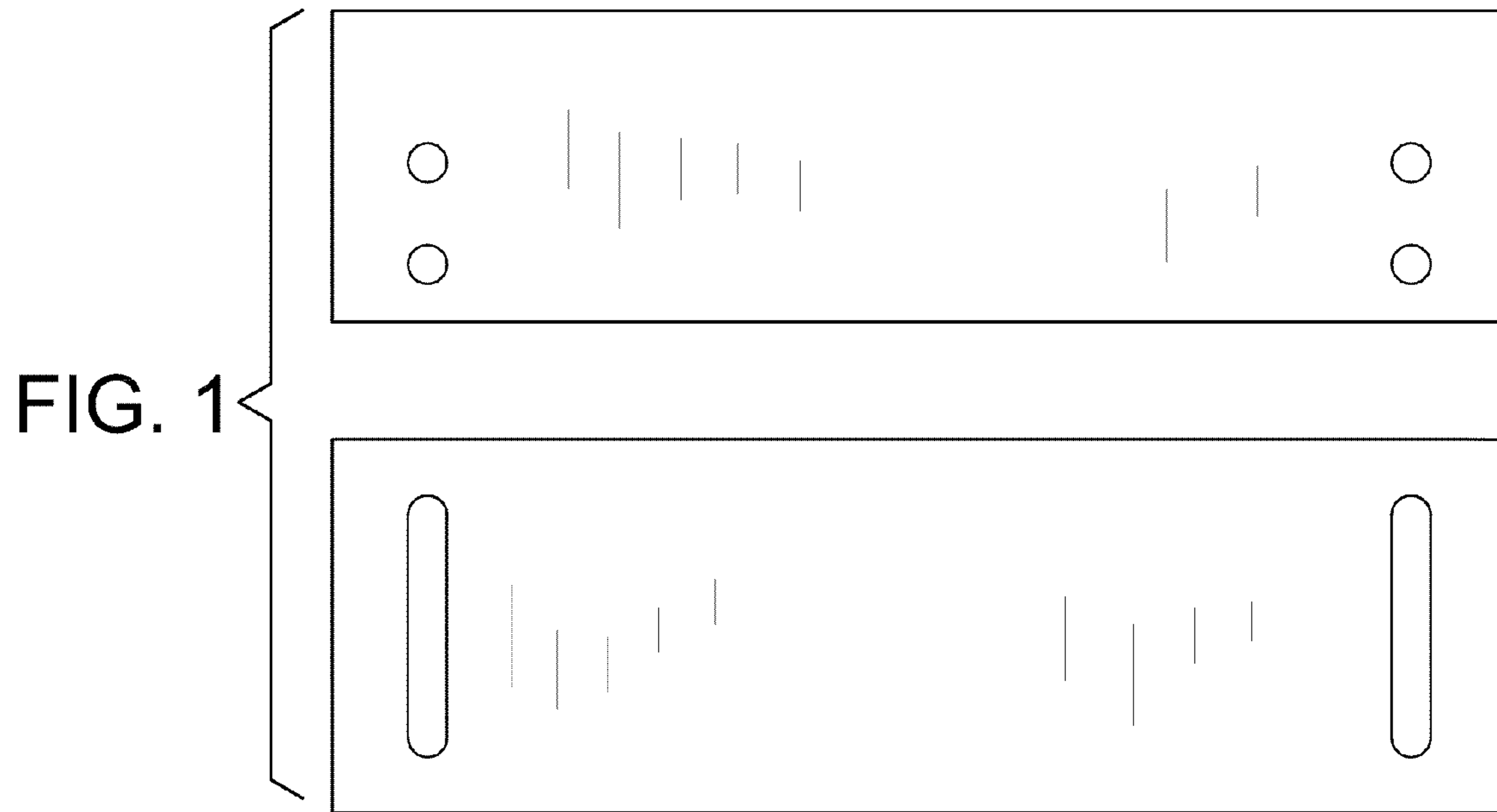

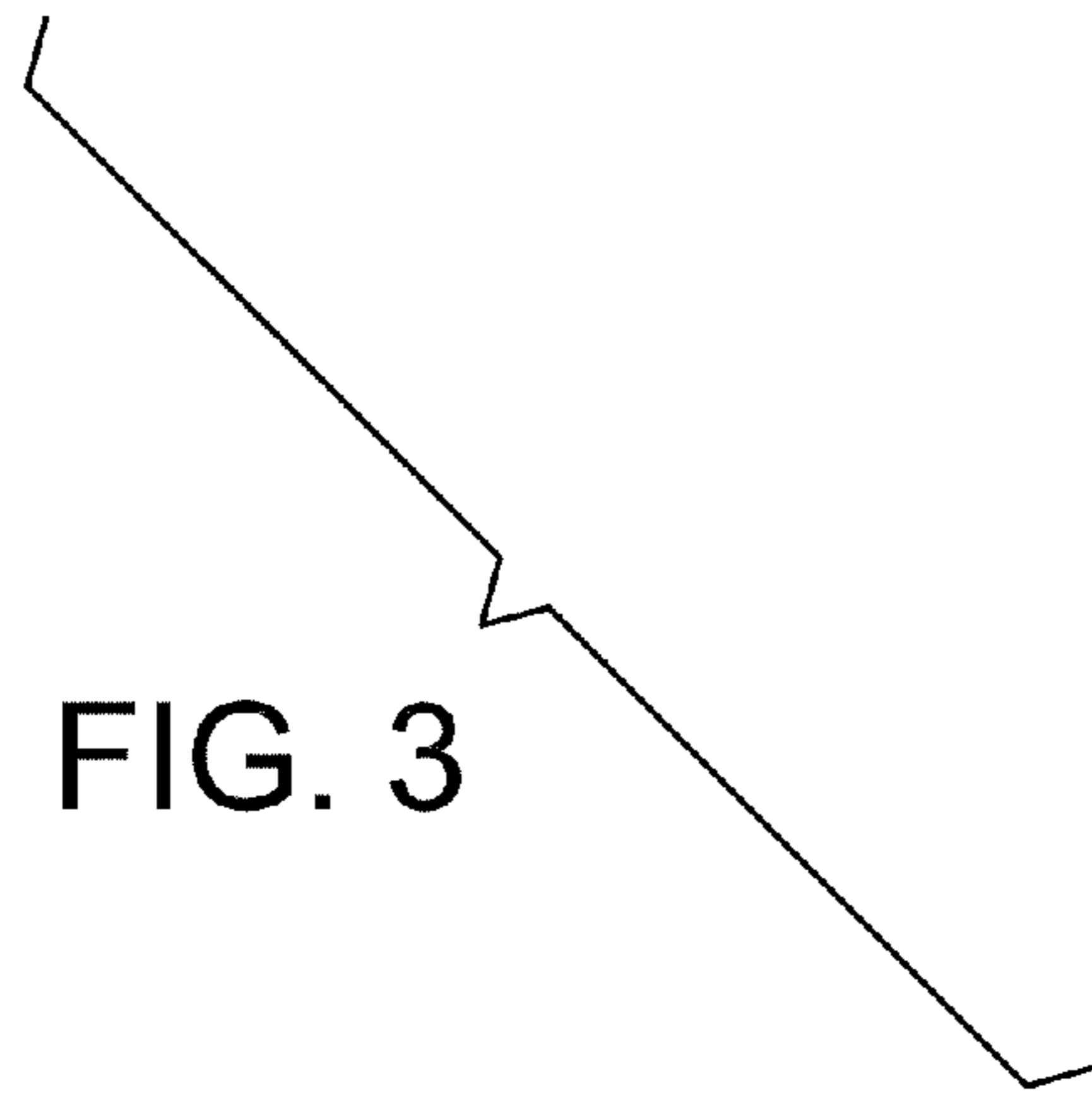
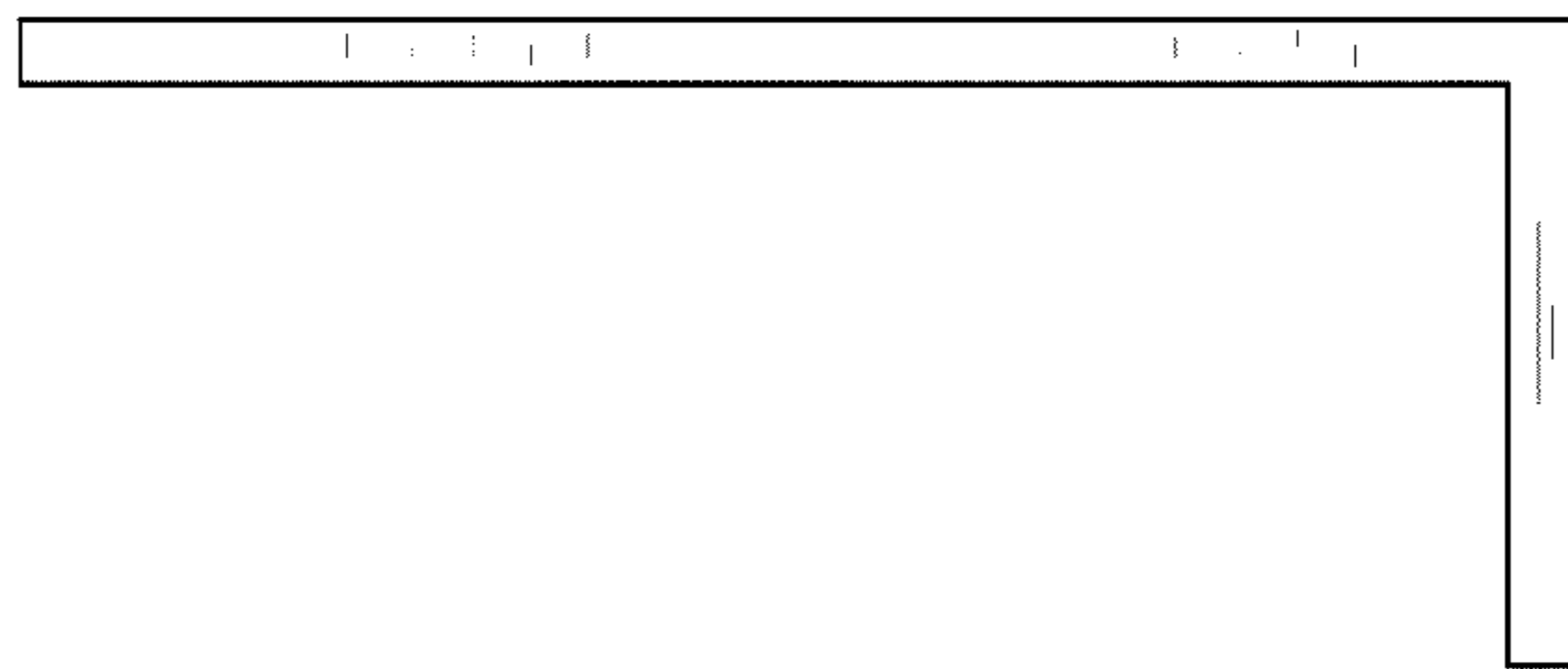

FIG. 3

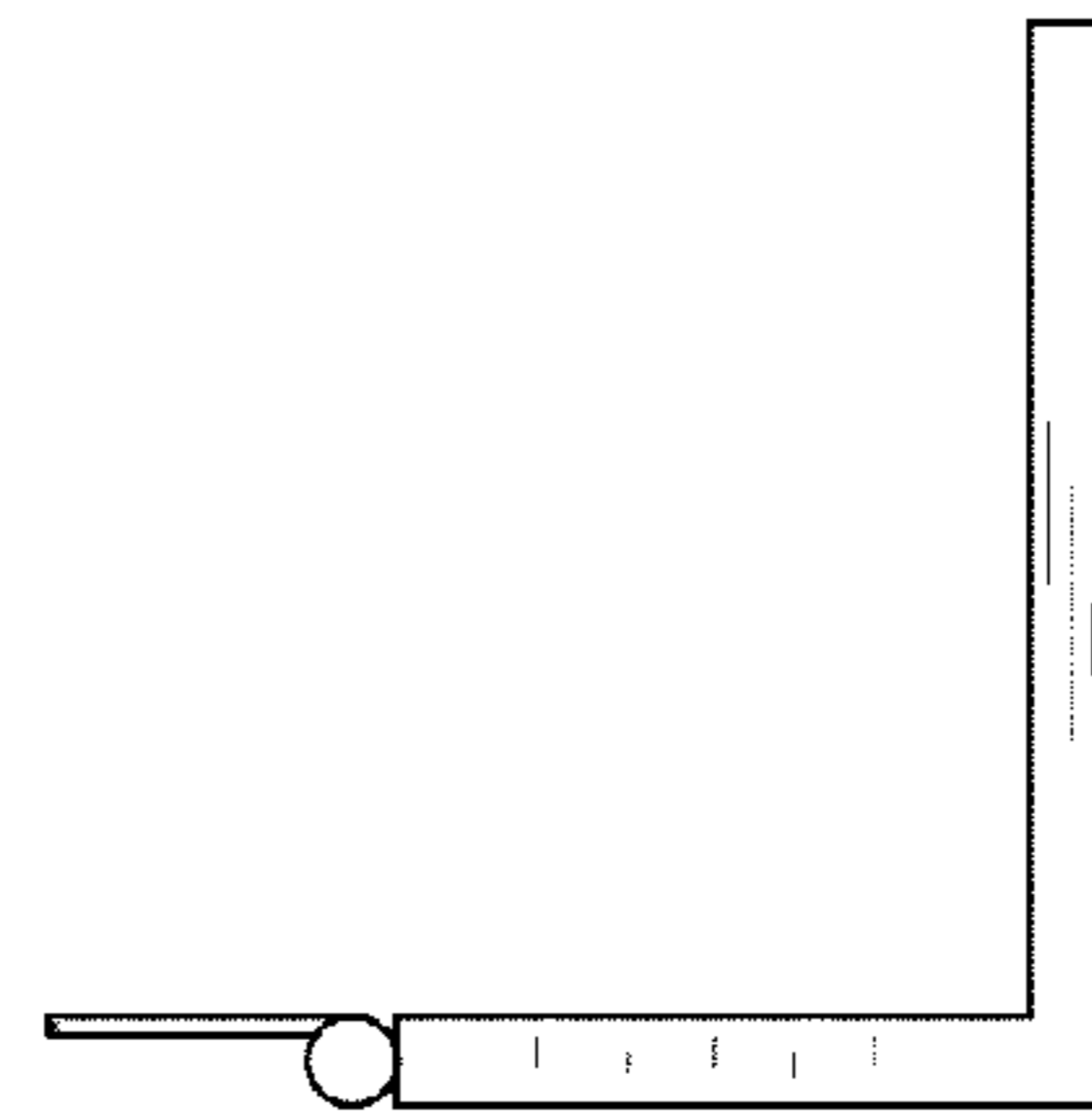

FIG. 4

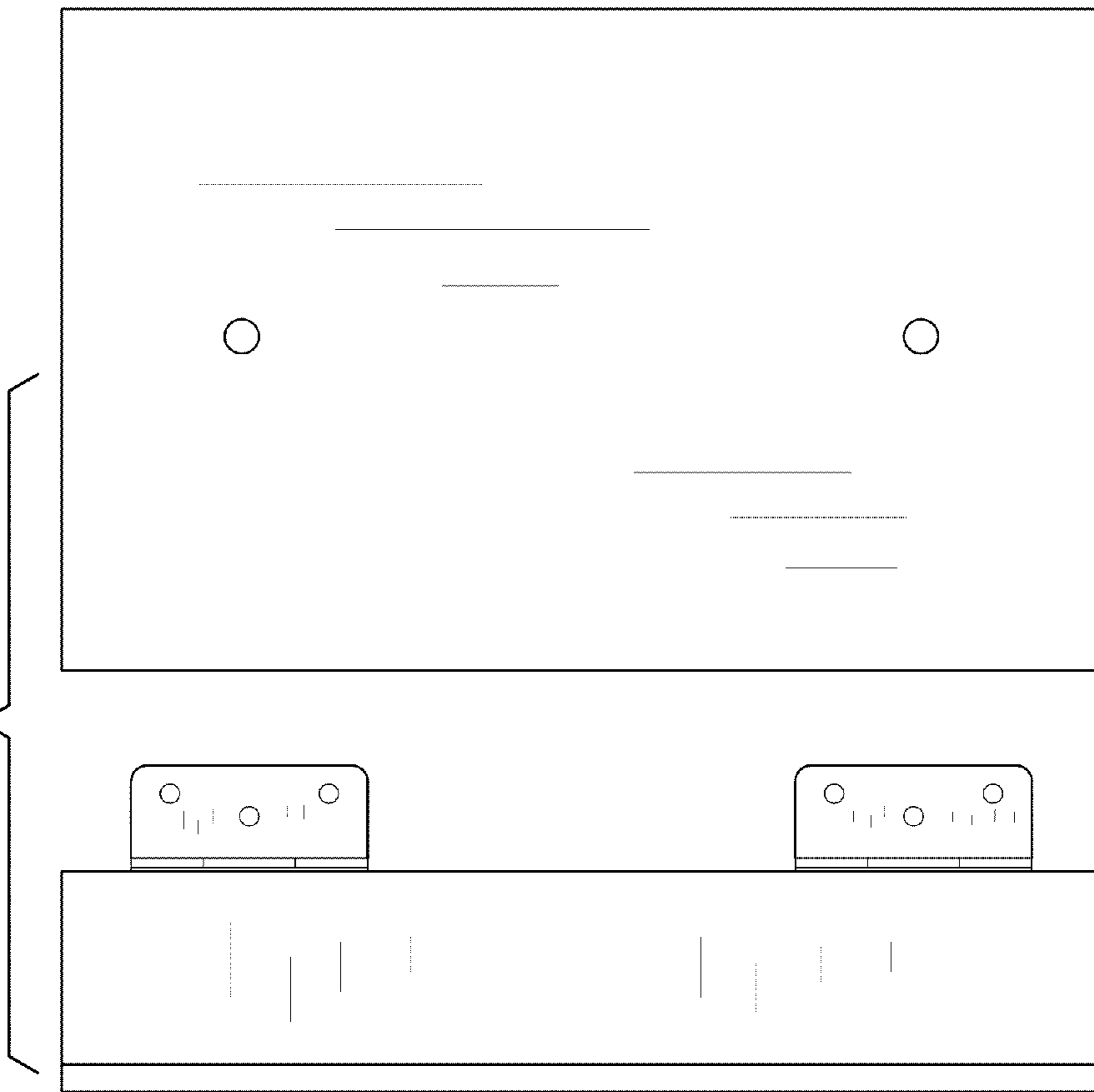
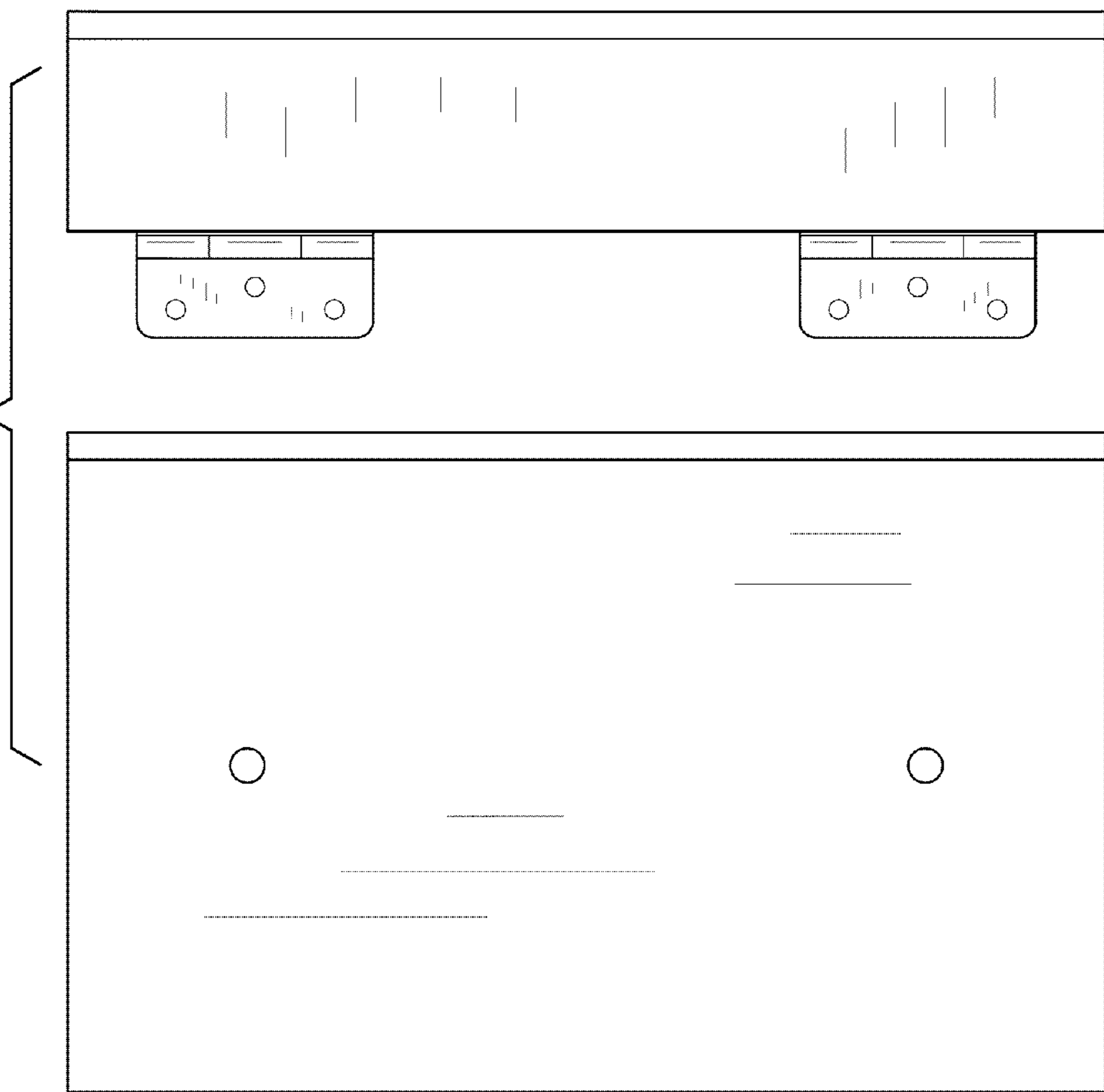

FIG. 5



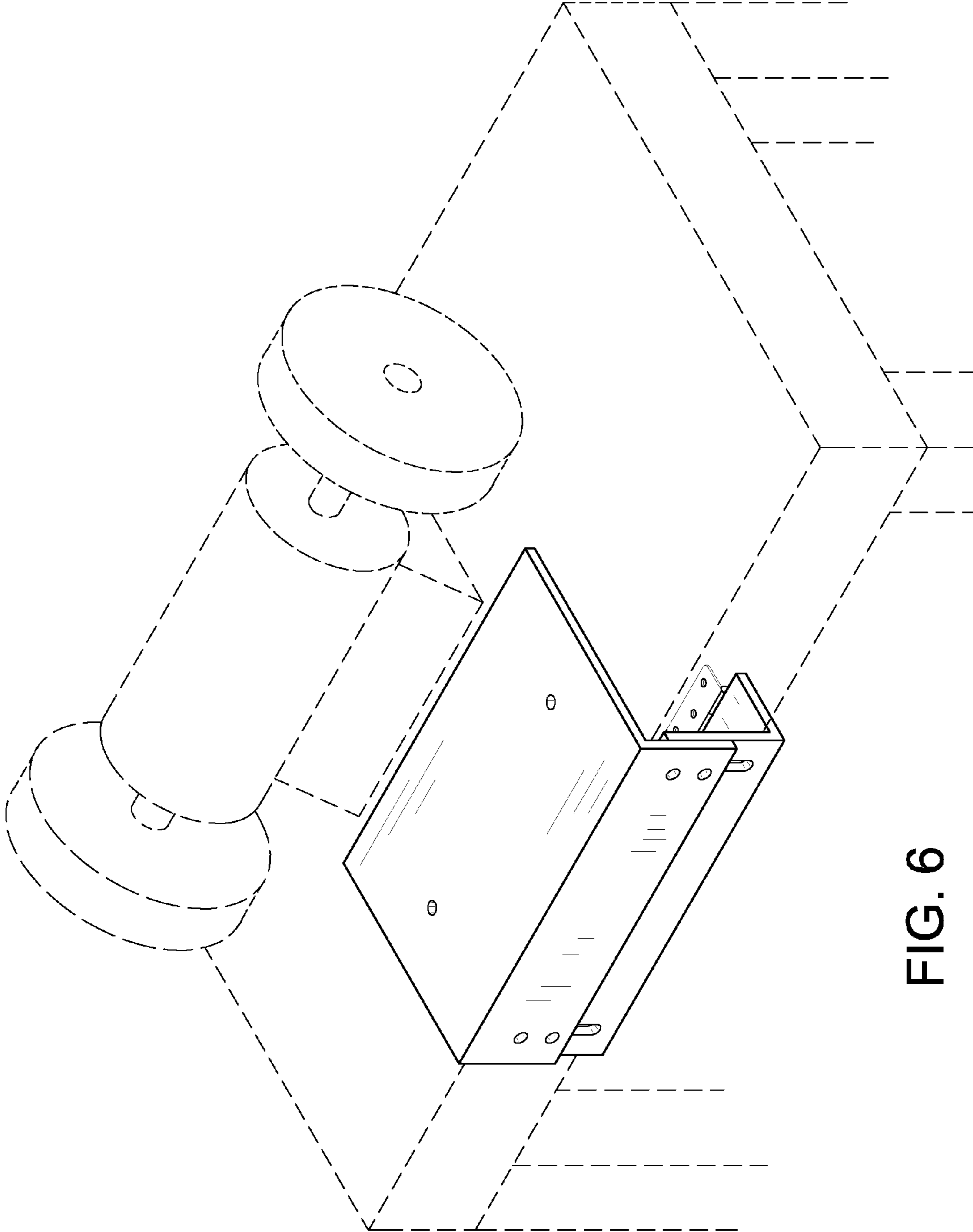

FIG. 6