



US00D647374S

(12) **United States Design Patent**
Garvin

(10) **Patent No.:** **US D647,374 S**

(45) **Date of Patent:** **** Oct. 25, 2011**

(54) **UTENSIL HOLDER**

(76) Inventor: **Edward D. Garvin**, Boone, NC (US)

(**) Term: **14 Years**

(21) Appl. No.: **29/391,475**

(22) Filed: **May 9, 2011**

Related U.S. Application Data

(63) Continuation-in-part of application No. 12/848,324, filed on Aug. 2, 2010, now abandoned.

(51) **LOC (9) Cl.** **07-06**

(52) **U.S. Cl.** **D7/637**

(58) **Field of Classification Search** D7/637-641;
211/70.7, 70.6; 248/37.3, 37.6, 37.7, 206.5,
248/231.81, 213.2, 316.1, 534, 535, 558
See application file for complete search history.

(56) **References Cited**

U.S. PATENT DOCUMENTS

1,601,572 A * 9/1926 Lester 248/37.3
D122,545 S * 9/1940 Frissell D7/637
D164,236 S * 8/1951 Hassler D6/572
4,193,572 A * 3/1980 Horiuchi et al. 248/535

4,632,347 A * 12/1986 Jurgich 248/213.2
4,867,410 A * 9/1989 Jurgich 248/558
5,083,733 A * 1/1992 Marino et al. 248/110
5,518,211 A * 5/1996 Gaskill et al. 248/37.6
5,730,405 A * 3/1998 Nichols, IV 248/213.2
2003/0116681 A1* 6/2003 Bullinger 248/37.6

* cited by examiner

Primary Examiner — Terry Wallace

(74) *Attorney, Agent, or Firm* — Olive Law Group, PLLC

(57) **CLAIM**

I claim the ornamental design for the utensil holder, as shown and described.

DESCRIPTION

FIG. 1 is a front-facing perspective view of the utensil holder according to the invention;

FIG. 2 is a rear-facing perspective view of the utensil holder of FIG. 1;

FIG. 3 is a front view of the utensil holder of FIG. 1;

FIG. 4 is a back view of the utensil holder of FIG. 1;

FIG. 5 is a side view of the utensil holder of FIG. 1;

FIG. 6 is a side view of the utensil holder of FIG. 1;

FIG. 7 is a bottom view of the utensil holder of FIG. 1; and,

FIG. 8 is a top view of the utensil holder of FIG. 1.

1 Claim, 8 Drawing Sheets

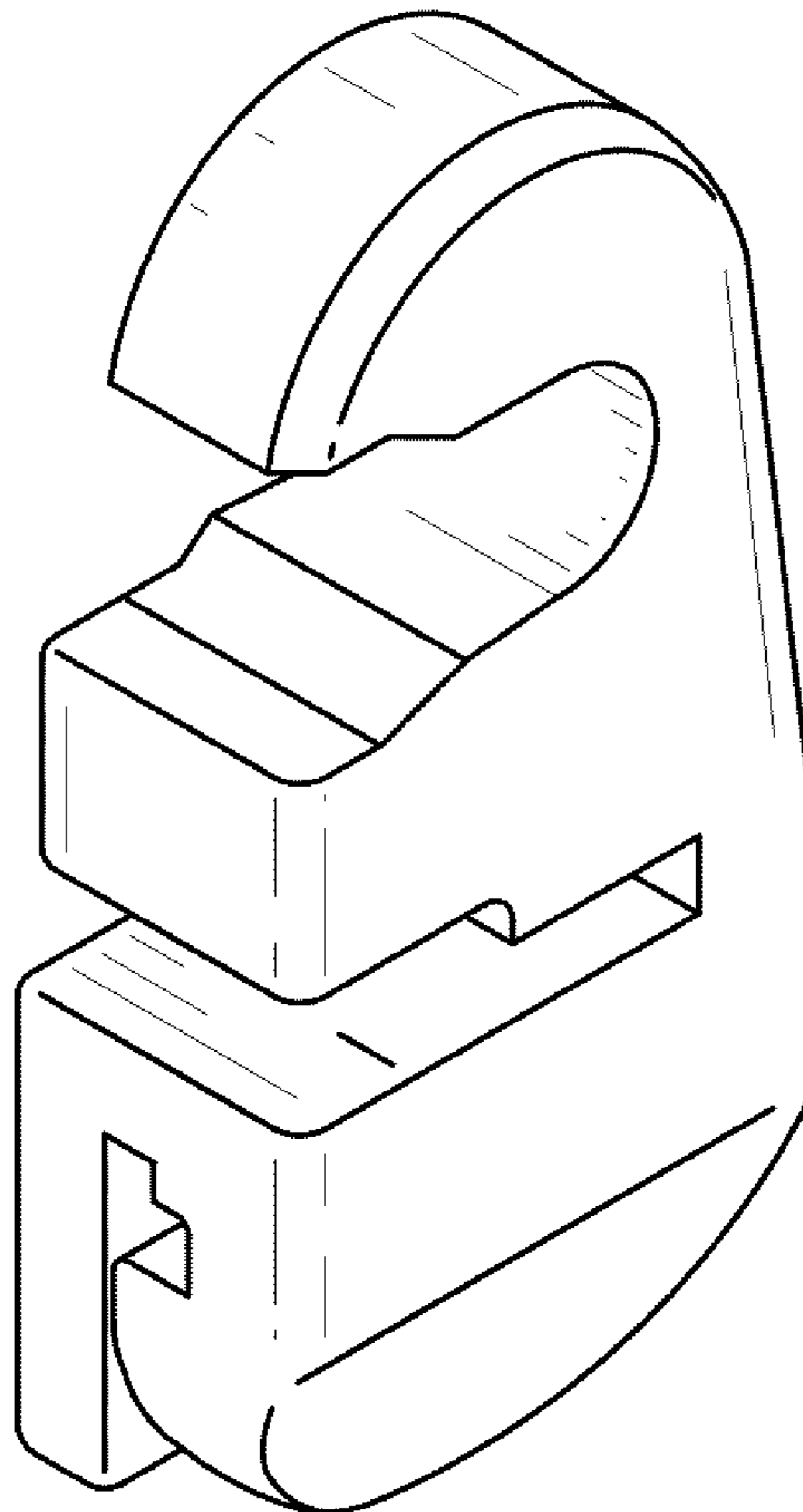

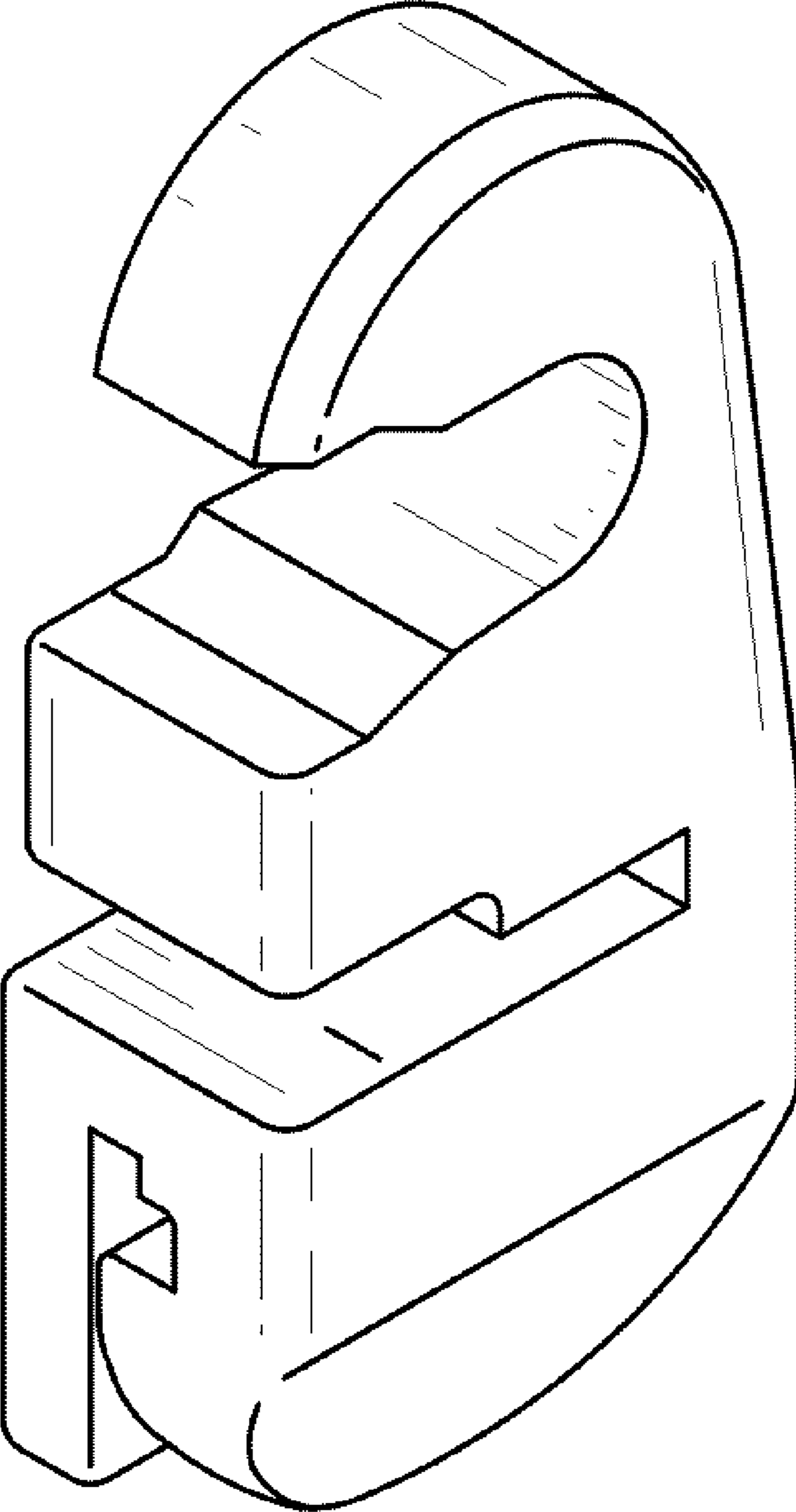

FIG. 1

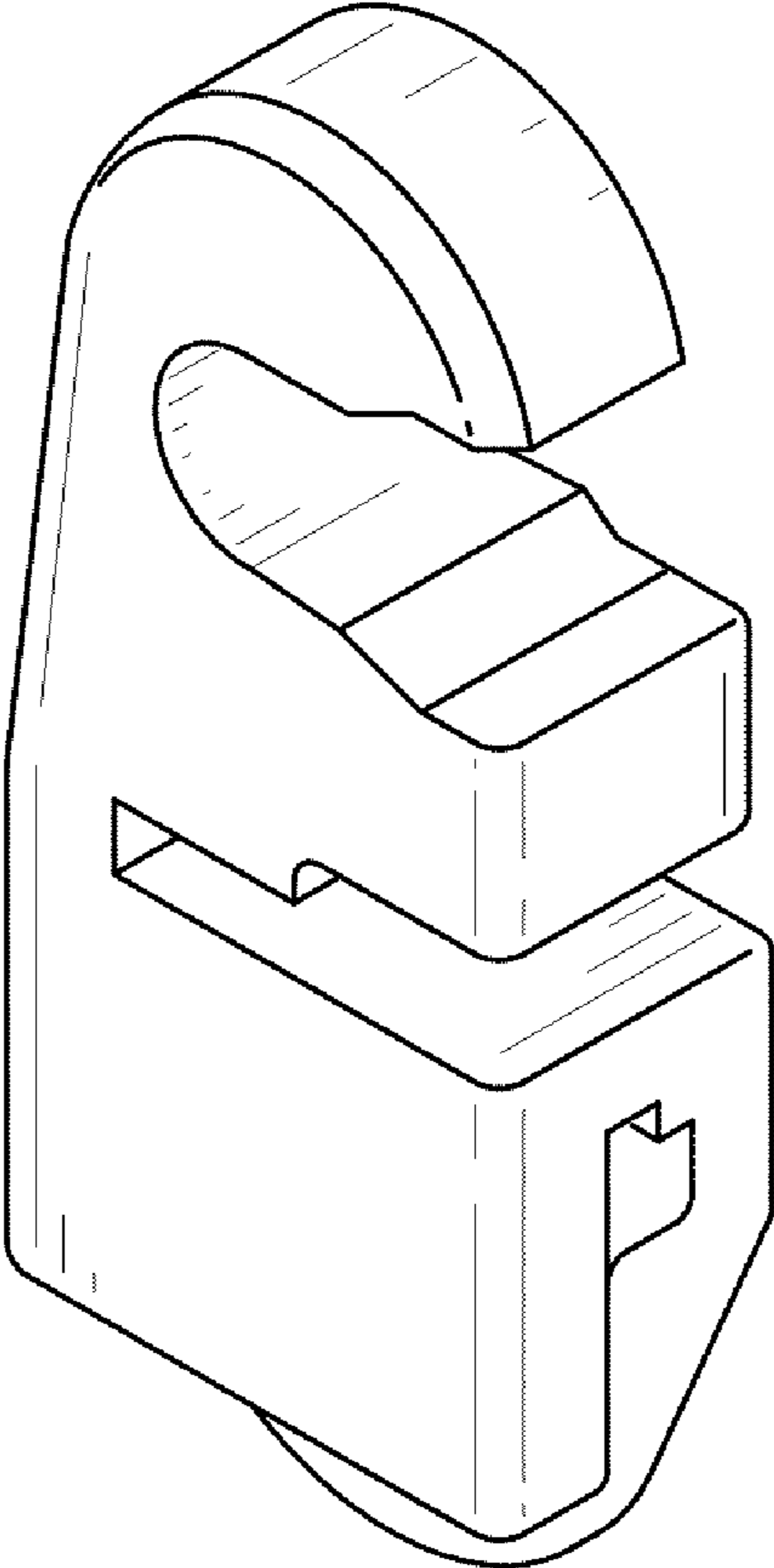

FIG. 2

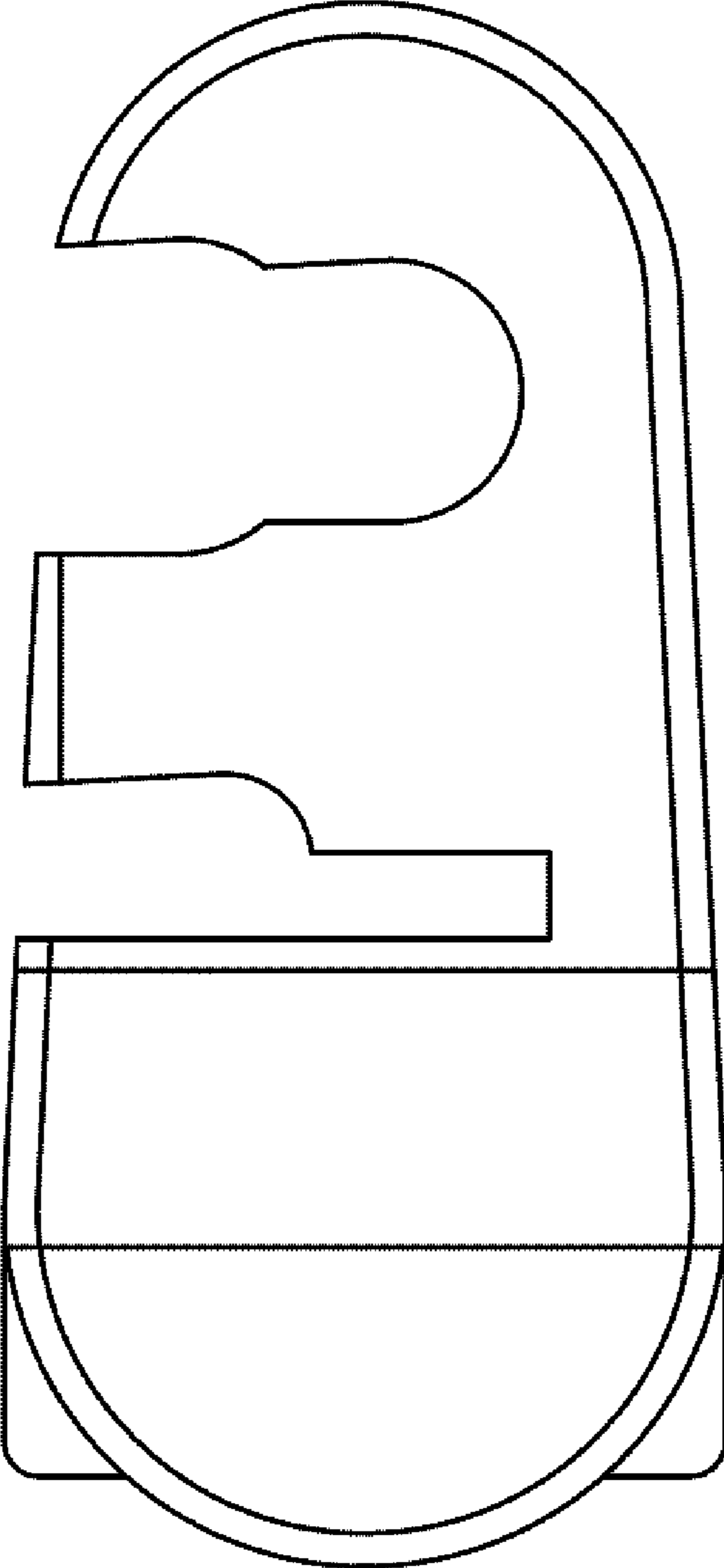

FIG. 3

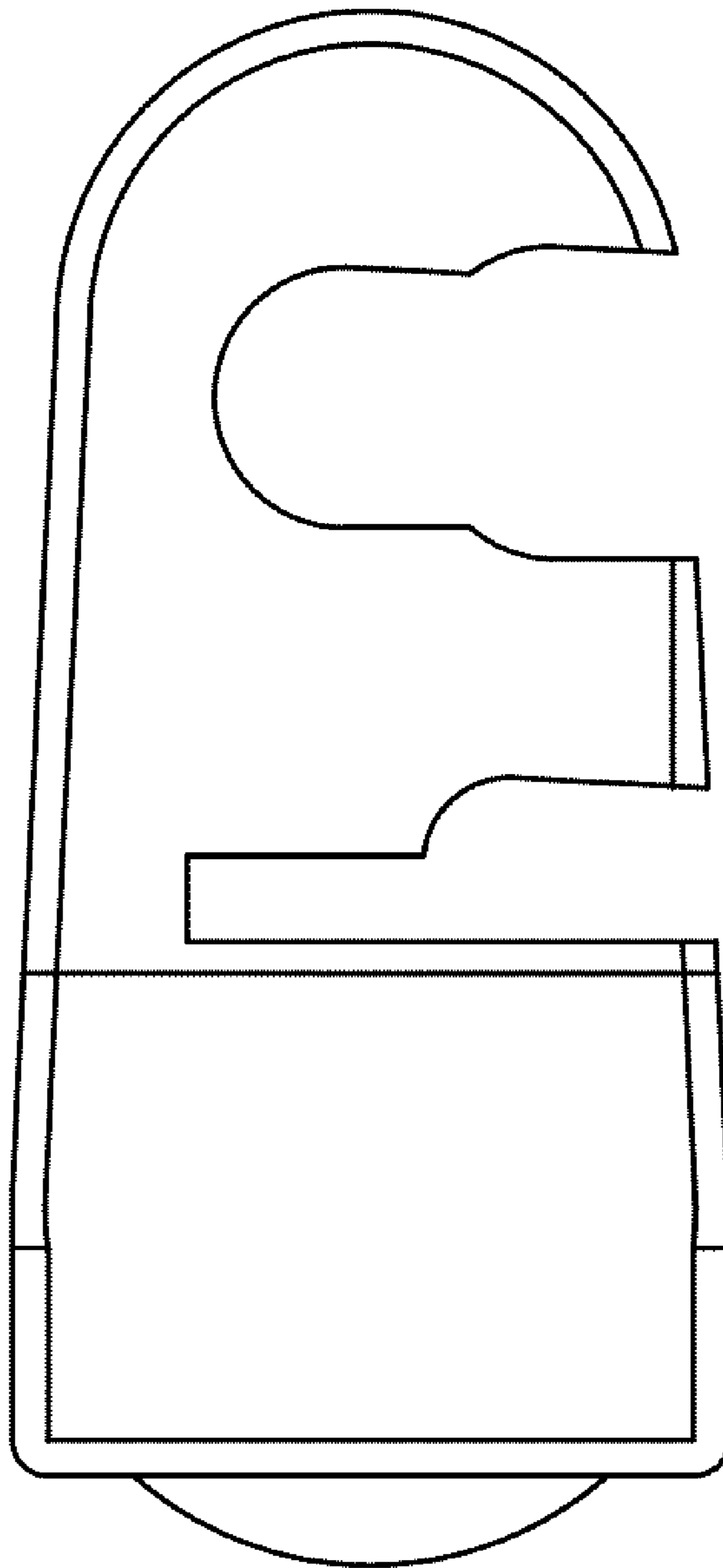

FIG. 4

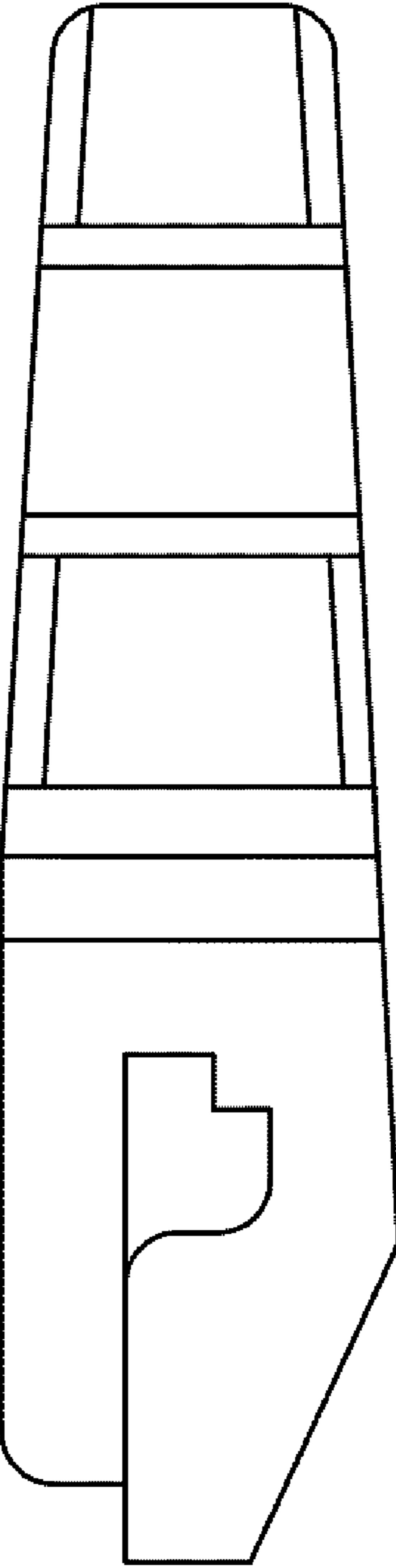

FIG. 5

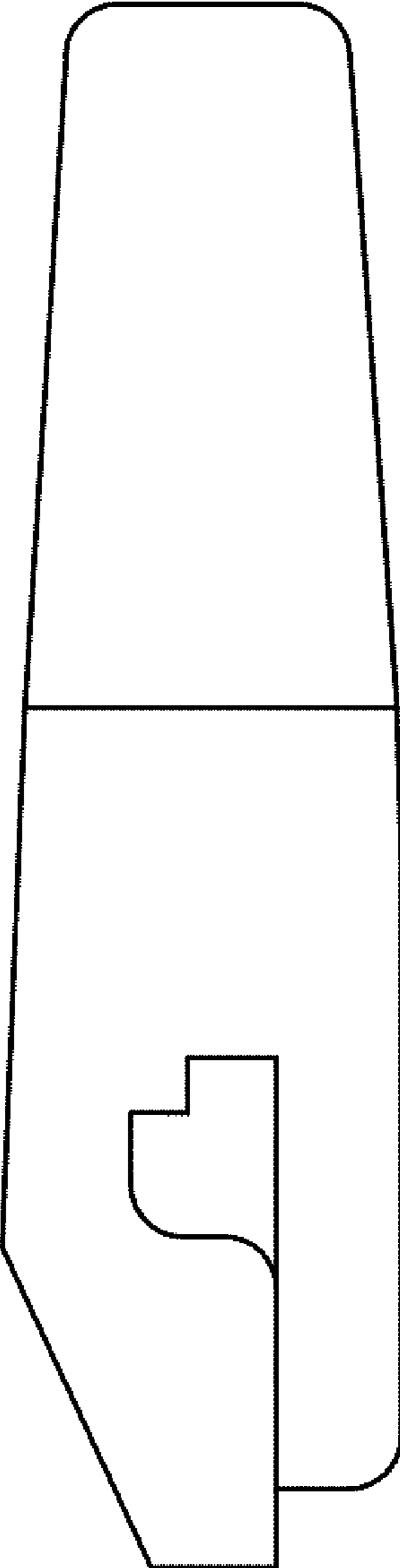

FIG. 6

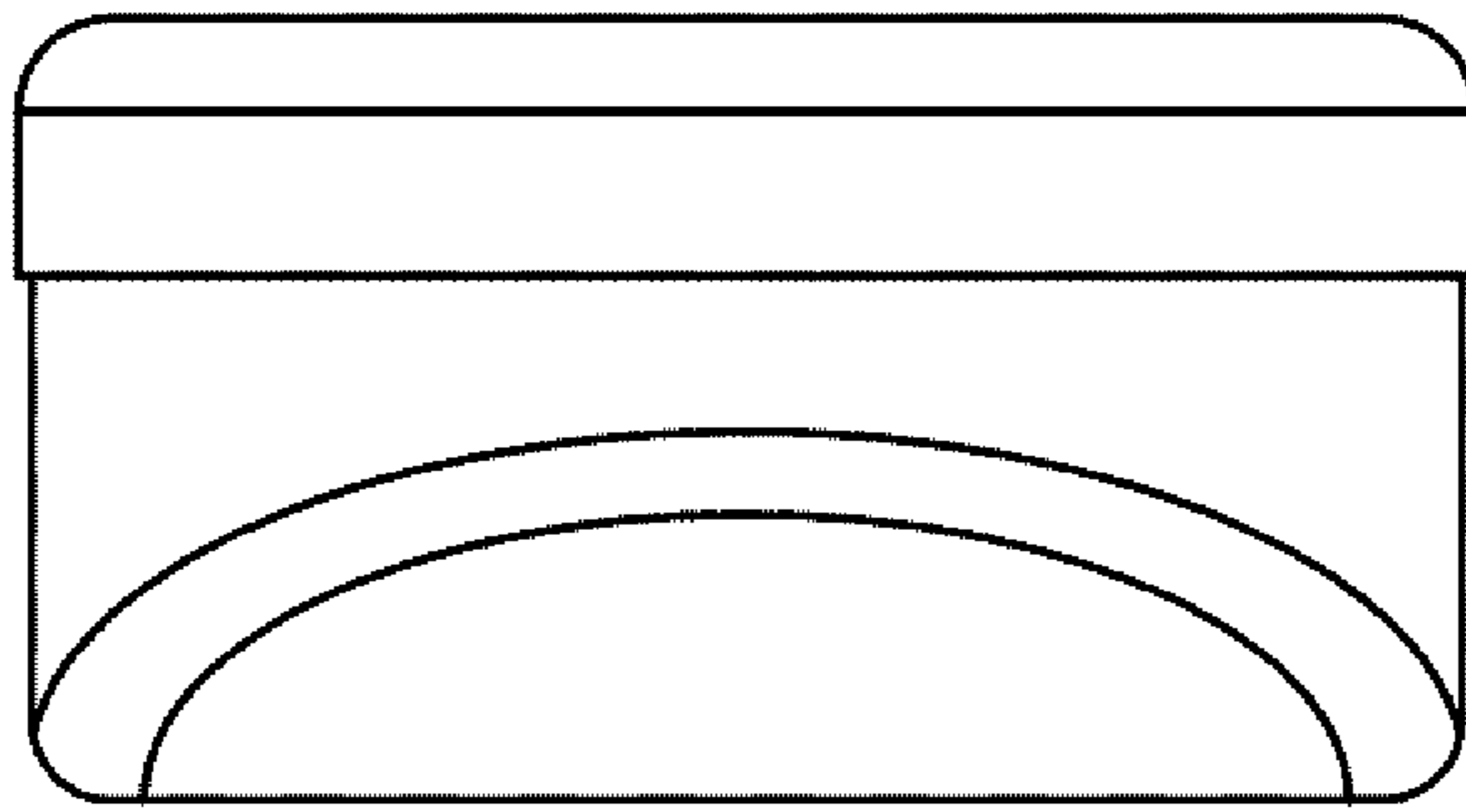

FIG. 7

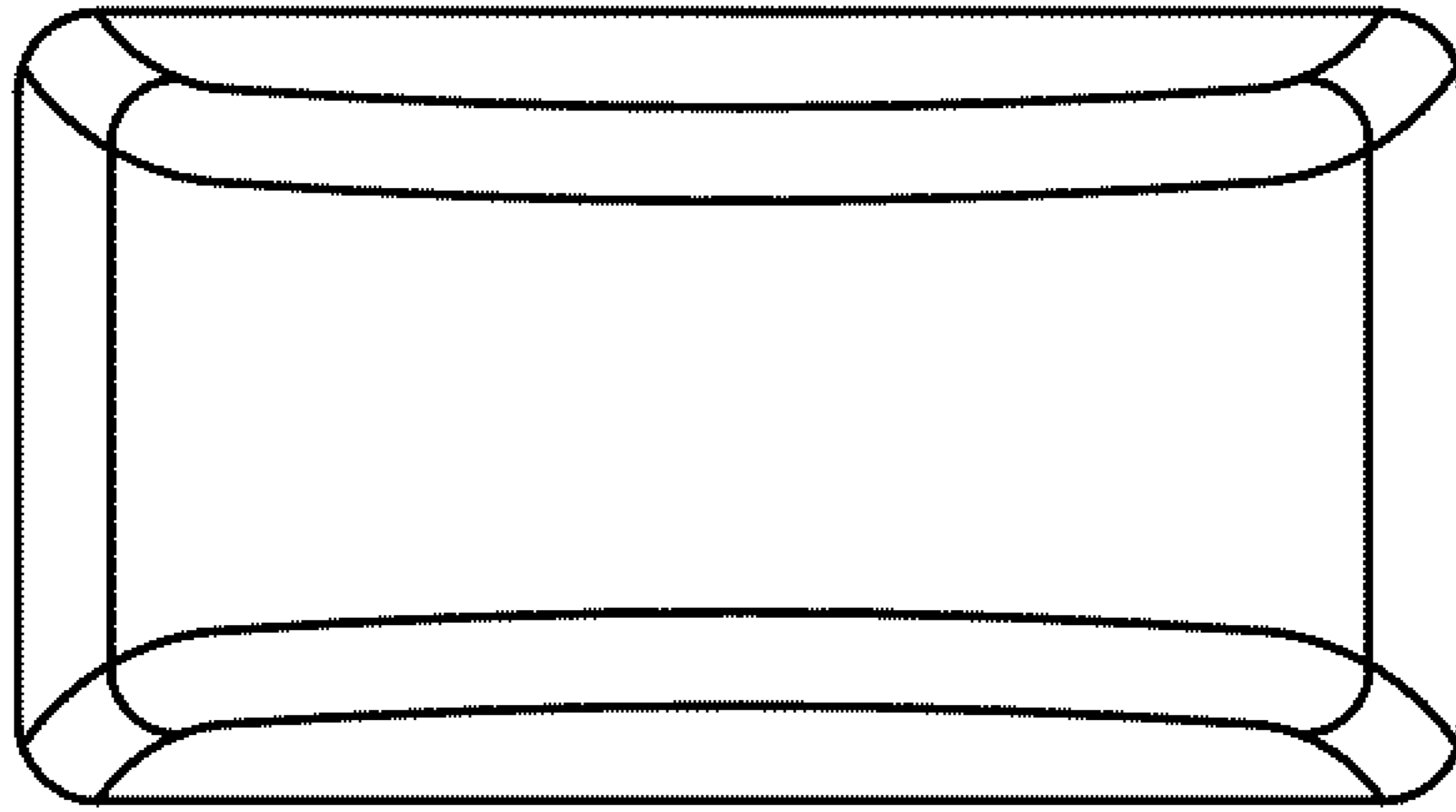

FIG. 8