



US00D647356S

(12) **United States Design Patent**  
**De' Longhi**

(10) **Patent No.:** **US D647,356 S**

(45) **Date of Patent:** **\*\* Oct. 25, 2011**

(54) **COFFEE MAKER**

(75) **Inventor:** **Giuseppe De' Longhi, Treviso (IT)**

(73) **Assignee:** **De'Longhi Appliances SRL Con Unico Socio, Treviso (IT)**

(\*\*) **Term:** **14 Years**

(21) **Appl. No.:** **29/383,118**

(22) **Filed:** **Jan. 12, 2011**

(30) **Foreign Application Priority Data**

Jul. 13, 2010 (EM) ..... 001224489-0004

(51) **LOC (9) Cl.** ..... **07-01**

(52) **U.S. Cl.** ..... **D7/309; D7/311**

(58) **Field of Classification Search** ..... D7/305-311,  
D7/300; 99/295, 304, 323, 293  
See application file for complete search history.

(56) **References Cited**

**U.S. PATENT DOCUMENTS**

D396,987 S *	8/1998	Seiffert	.....	D7/309
D486,345 S *	2/2004	Schwamkrug	.....	D7/309
D523,279 S *	6/2006	Zemp	.....	D7/309
D526,524 S *	8/2006	Jordana	.....	D7/309

D584,096 S *	1/2009	Lutz	.....	D7/307
D586,603 S *	2/2009	Borin	.....	D7/309
D586,604 S *	2/2009	Buttler	.....	D7/309
D587,511 S *	3/2009	Buttler	.....	D7/309
D595,991 S *	7/2009	Zimmerman	.....	D7/307
D601,848 S *	10/2009	Borin	.....	D7/309
D610,389 S *	2/2010	Borin et al.	.....	D7/309
D622,534 S *	8/2010	Zimmermann	.....	D7/307
D630,880 S *	1/2011	Zimmermann	.....	D7/309
D638,650 S *	5/2011	Galeazzi	.....	D7/309

\* cited by examiner

*Primary Examiner* — Marianne Pandozzi

(74) *Attorney, Agent, or Firm* — Hamre, Schumann, Mueller & Larson, P.C.

(57) **CLAIM**

The ornamental design for a coffee maker, as shown and described.

**DESCRIPTION**

FIG. 1 is a front right perspective view of a coffee maker showing my new design;  
FIG. 2 is a front view thereof;  
FIG. 3 is a back view thereof;  
FIG. 4 is a right side view thereof;  
FIG. 5 is a left side view thereof.  
FIG. 6 is a top view thereof; and,  
FIG. 7 is a bottom view thereof.

**1 Claim, 7 Drawing Sheets**

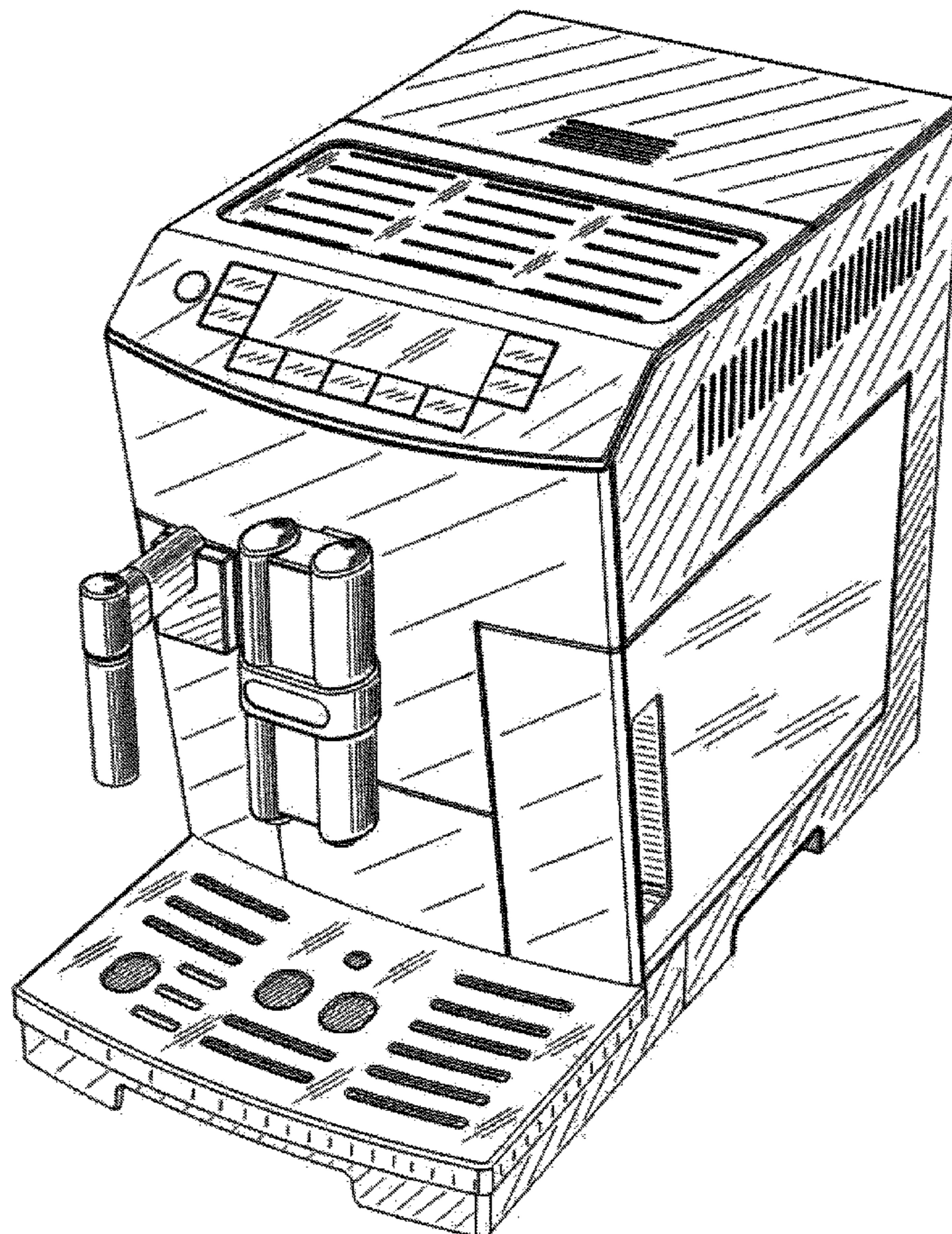



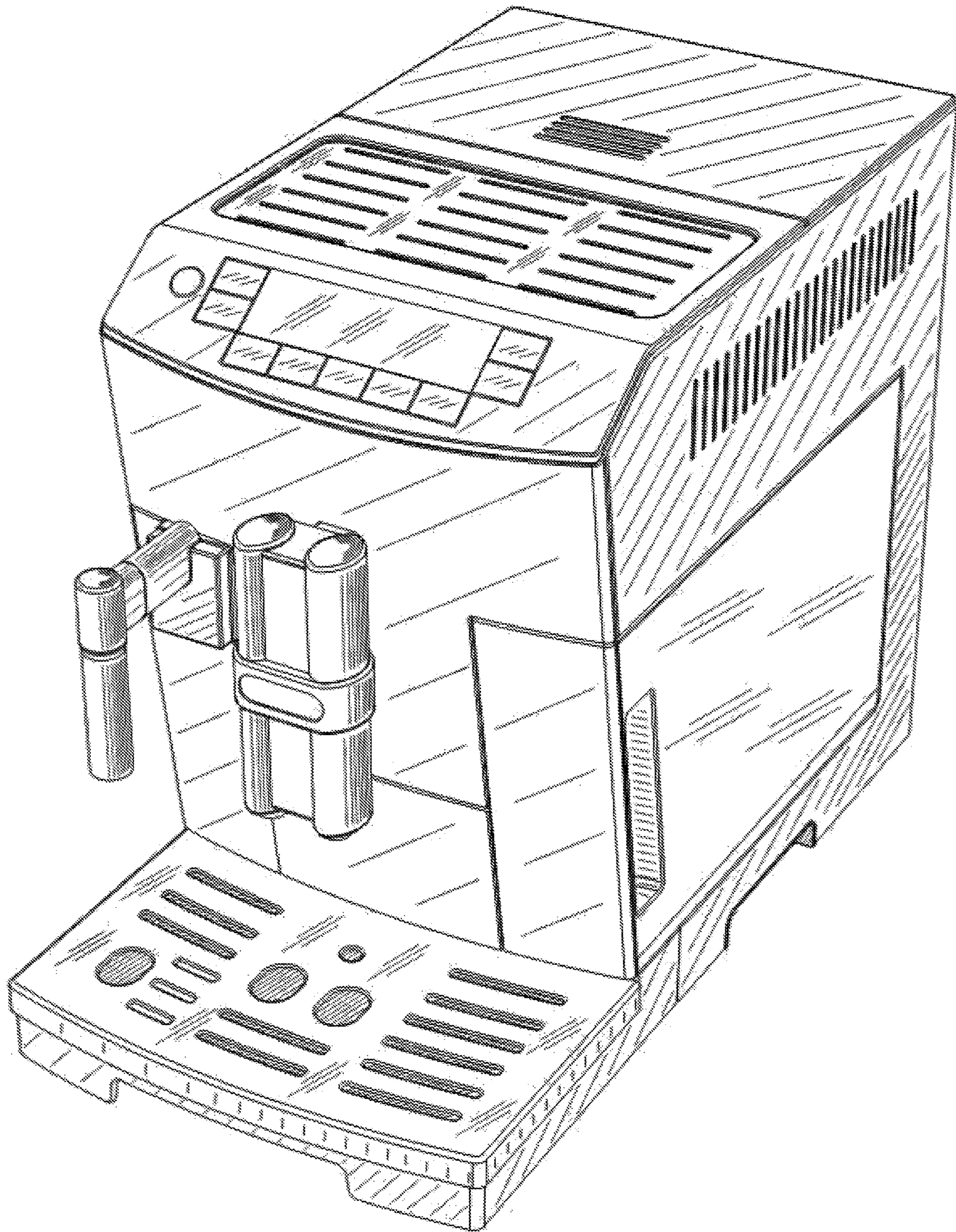

FIG. 1



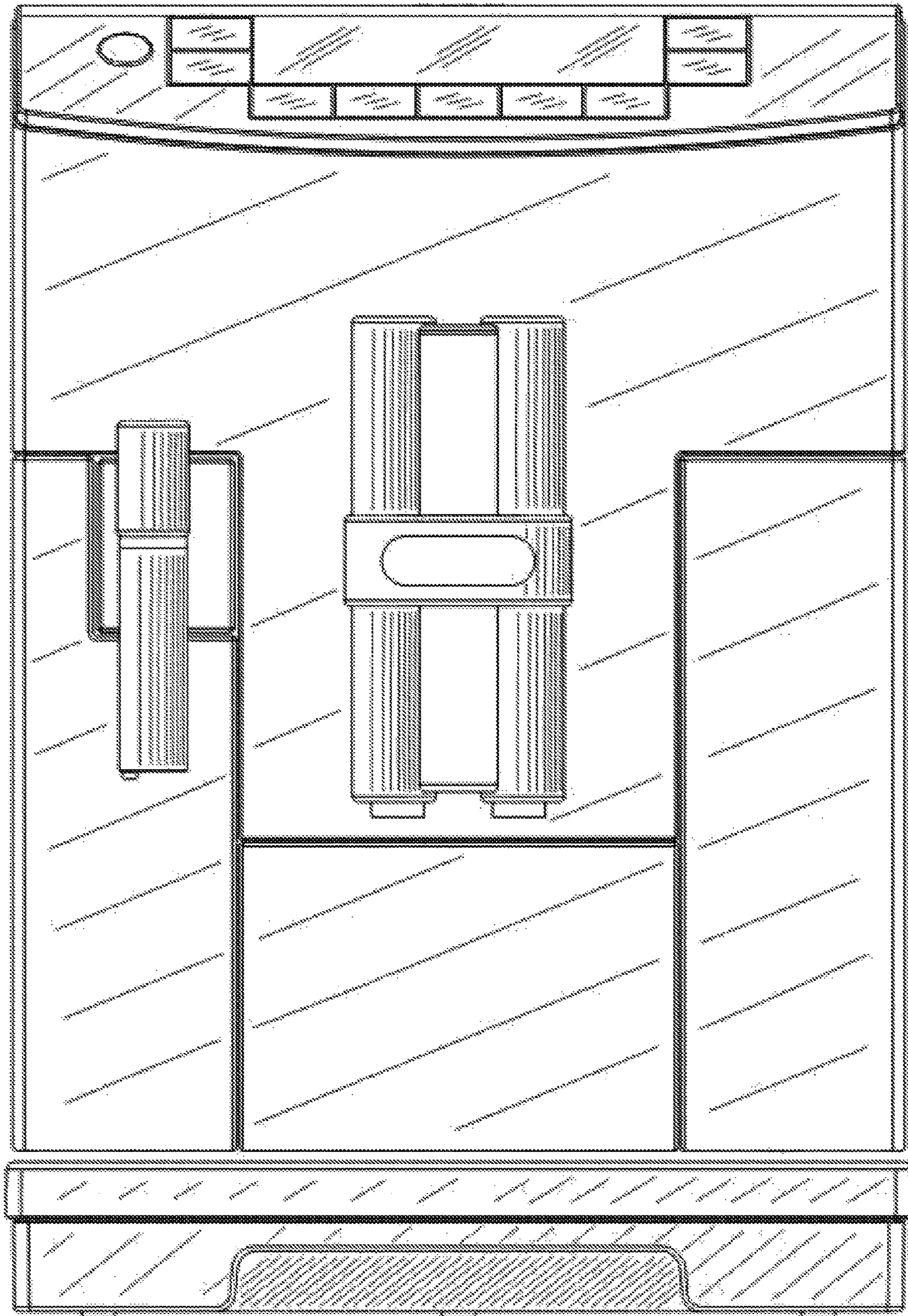

FIG. 2



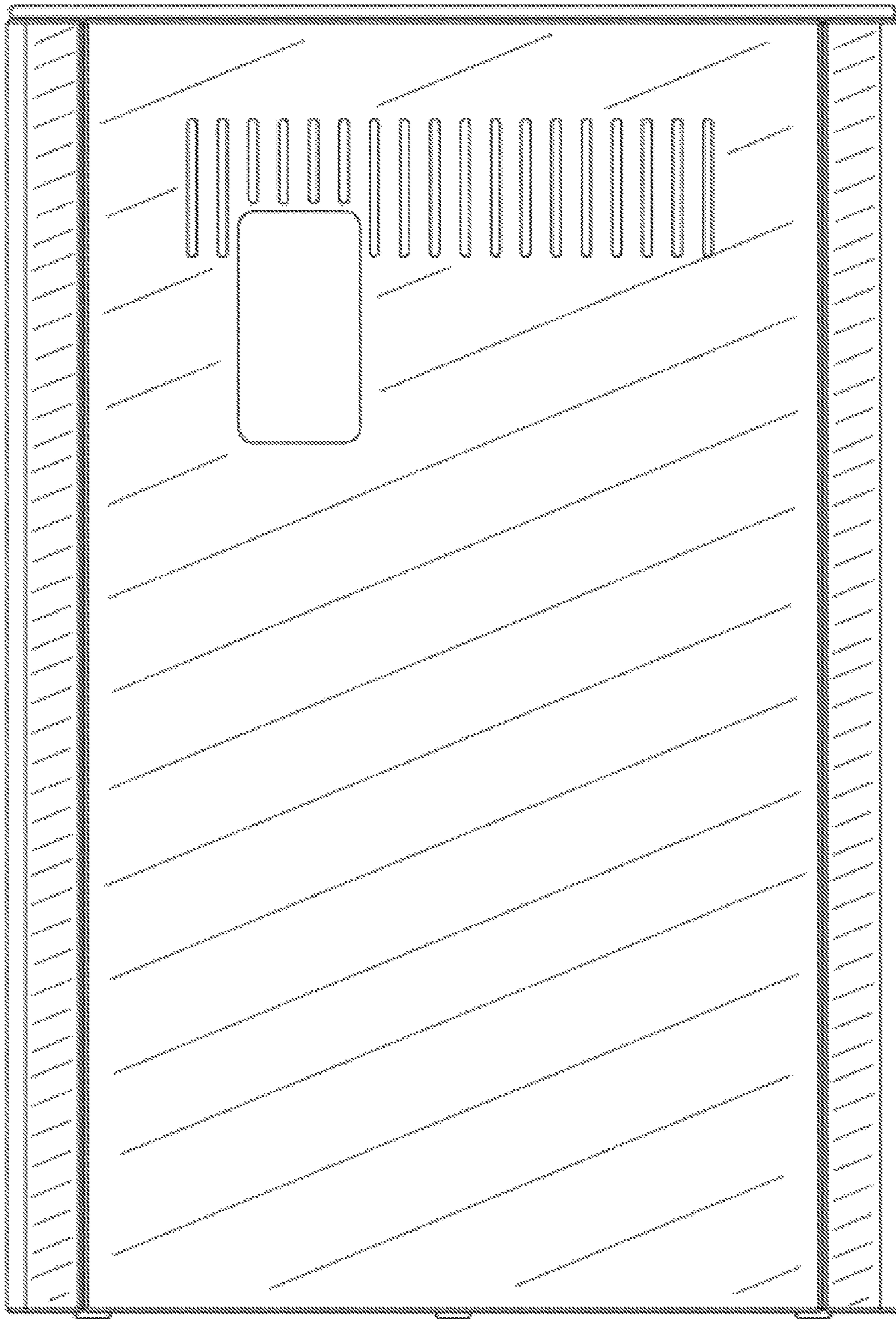

FIG. 3

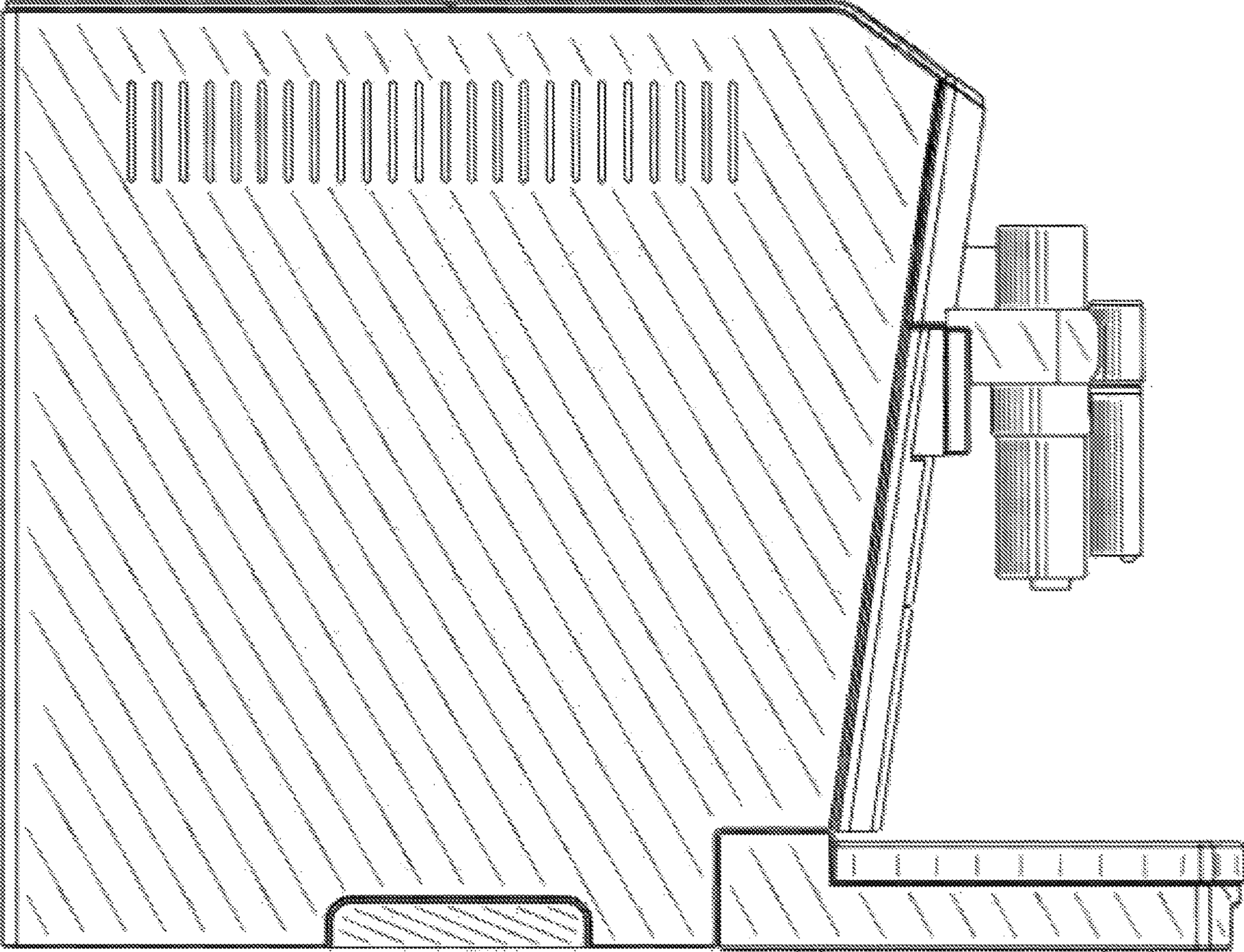

FIG. 4



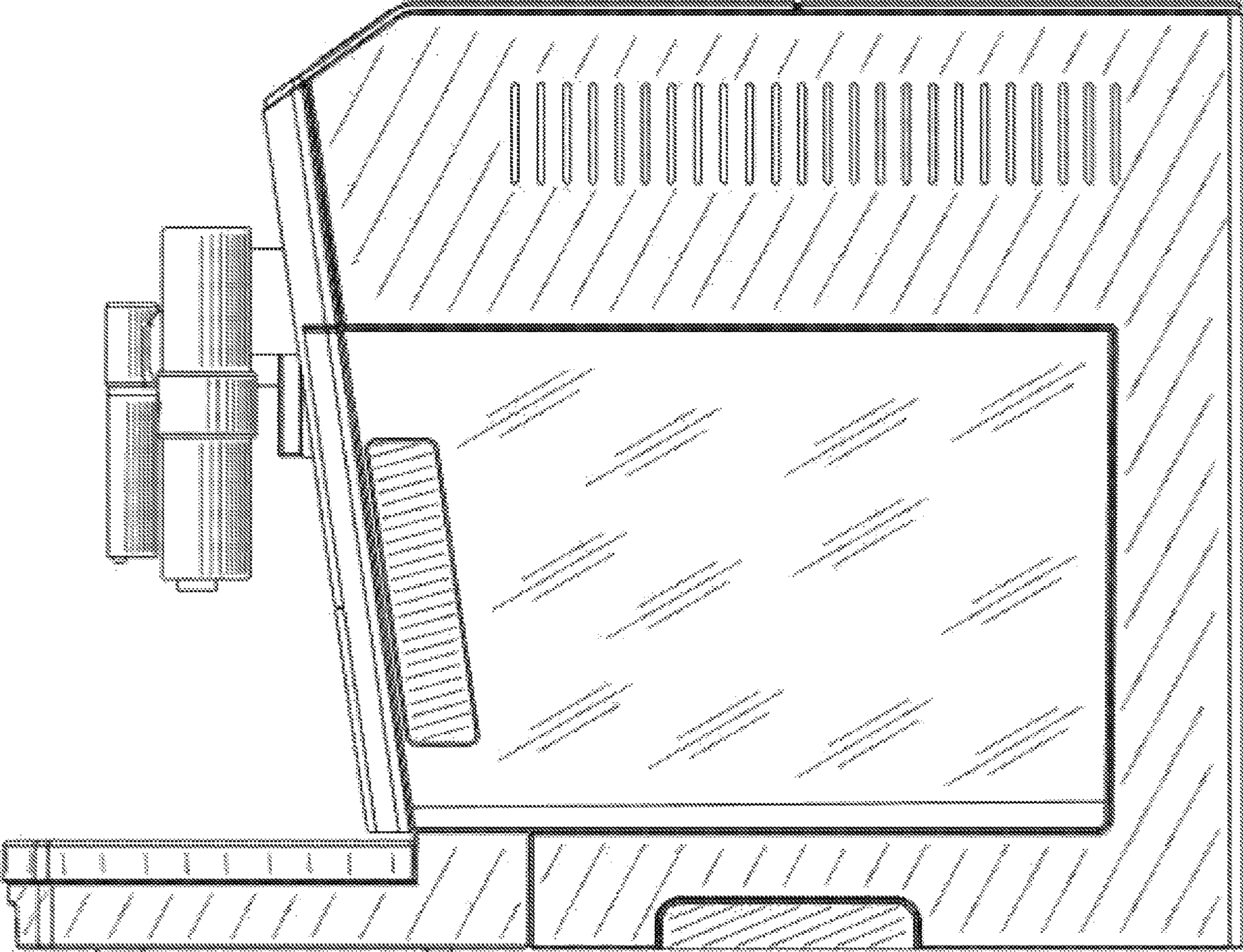

FIG. 5



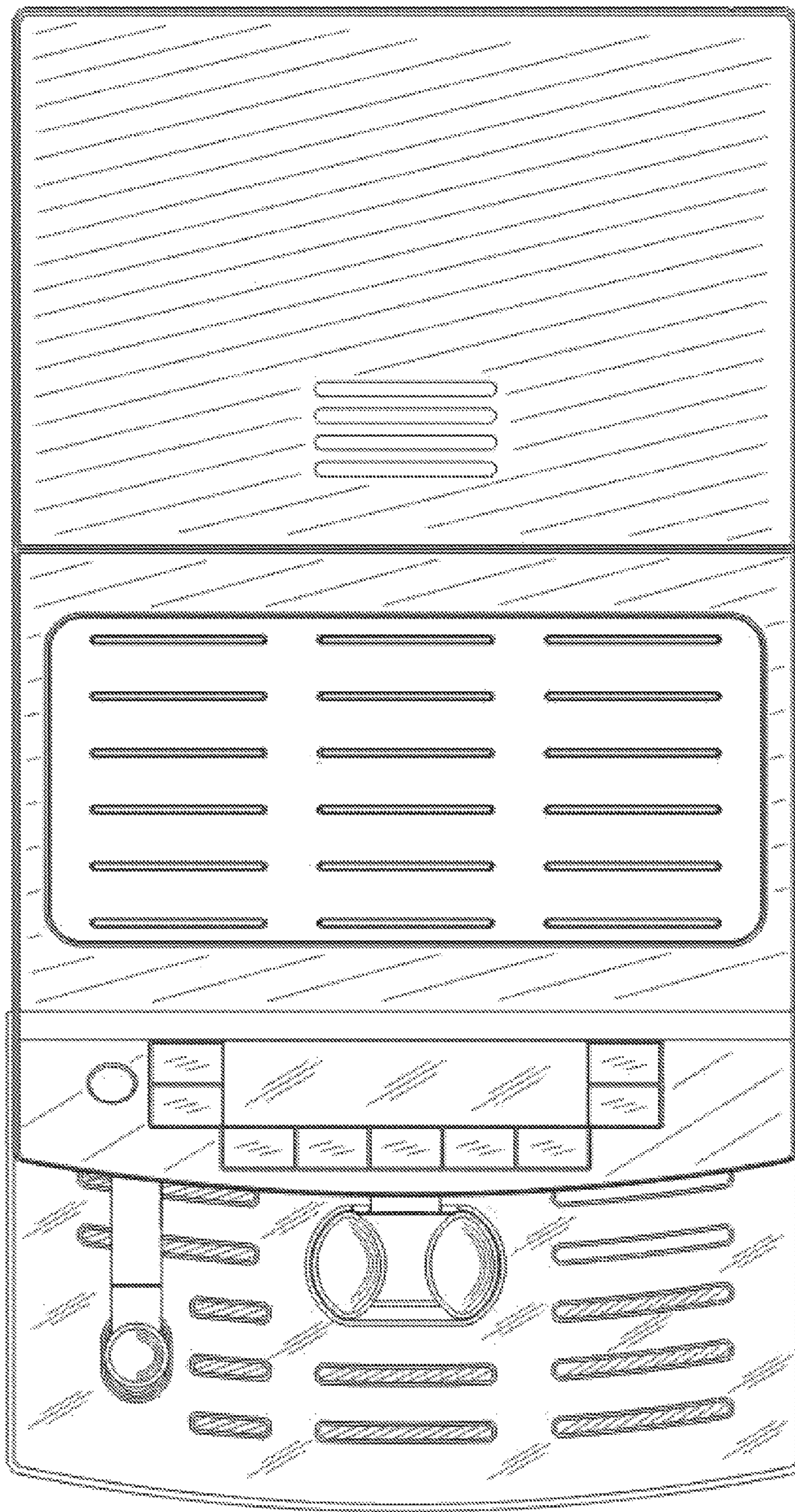

FIG. 6

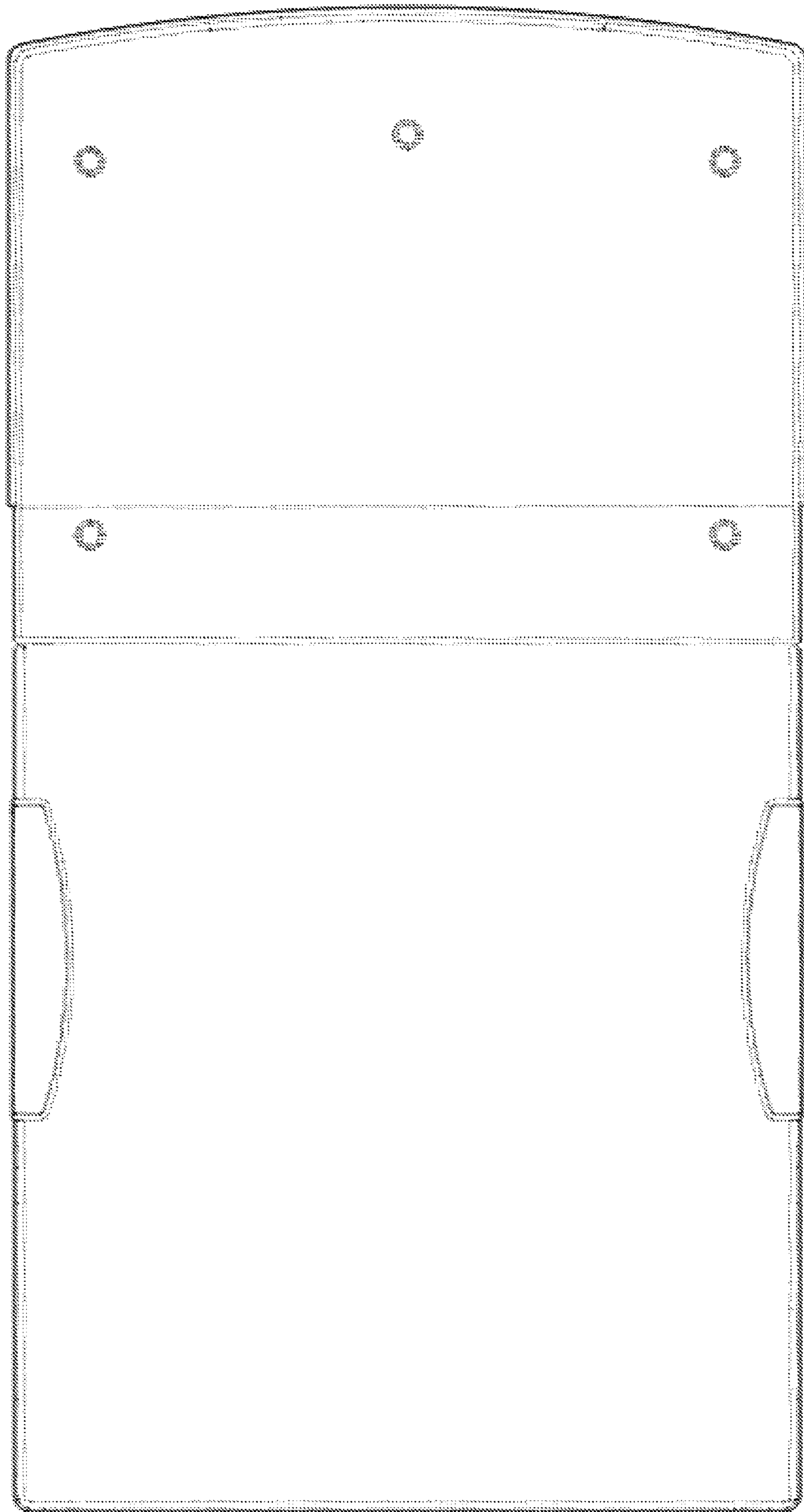

FIG. 7