



US00D647344S

(12) **United States Design Patent**
Goeckel et al.

(10) **Patent No.:** **US D647,344 S**

(45) **Date of Patent:** **** *Oct. 25, 2011**

(54) **INFLATABLE SEAT CUSHION**

(75) Inventors: **Gregory W. Goeckel**, Belleville, IL
(US); **David K. Parsons**, Swansea, IL
(US)

(73) Assignee: **Roho, Inc.**, Belleville, IL (US)

(*) Notice: This patent is subject to a terminal disclaimer.

(**) Term: **14 Years**

(21) Appl. No.: **29/367,603**

(22) Filed: **Aug. 10, 2010**

Related U.S. Application Data

(63) Continuation-in-part of application No. 29/354,169, filed on Jan. 20, 2010.

(51) **LOC (9) Cl.** **06-09**

(52) **U.S. Cl.** **D6/601; D6/604**

(58) **Field of Classification Search** D6/595-601,
D6/604, 605, 606, 611; 5/653, 654, 655.3,
5/655.5, 710, 644, 645, 909, 648, 630, 633,
5/636, 652, 655.9, 657; 297/219.1, 452.26,
297/452.27, 452.41, DIG. 3

See application file for complete search history.

(56) **References Cited**

U.S. PATENT DOCUMENTS

3,605,145	A	9/1971	Graebe	
4,422,194	A *	12/1983	Viesturs et al.	5/686
4,485,505	A *	12/1984	Paul	5/714
4,541,136	A *	9/1985	Graebe	5/655.3
4,730,610	A	3/1988	Graebe	
4,809,374	A *	3/1989	Saviez	5/420
4,860,397	A *	8/1989	Gusakov	5/707
5,029,939	A *	7/1991	Smith et al.	297/284.1
5,052,068	A *	10/1991	Graebe	5/654
5,111,544	A *	5/1992	Graebe	5/654
5,152,023	A	10/1992	Graebe	
5,160,785	A *	11/1992	Davidson, Jr.	428/316.6

D338,363	S *	8/1993	Martel	D6/604
5,243,722	A *	9/1993	Gusakov	5/655.3
D342,411	S	12/1993	Graebe	
5,317,773	A	6/1994	Graebe	
D355,558	S	2/1995	Graebe	
5,461,741	A *	10/1995	Graebe	5/654

(Continued)

Primary Examiner — Lucy Lieberman

(74) *Attorney, Agent, or Firm* — Polster Lieder Woodruff & Lucchesi, L.C.

(57) **CLAIM**

The ornamental design for an inflatable seat cushion, as shown and described.

DESCRIPTION

FIG. 1 is a top, front and side perspective view of an inflatable seat cushion showing our new design with the front and side flaps folded up as in use;

FIG. 2 is top plan view of FIG. 1;

FIG. 3 is a bottom plan view of FIG. 1;

FIG. 4 is a front elevational view of FIG. 1,

FIG. 5 is the right side elevational view of FIG. 1;

FIG. 6 is the left side elevational view of FIG. 1;

FIG. 7 is a top, front and side perspective view of the inflatable seat cushion with the front and side flaps folded up and shown in an unclaimed foam base to illustrate environment;

FIG. 8 is a top plan view of FIG. 7;

FIG. 9 is a front elevational view of FIG. 7;

FIG. 10 is a right side elevational view of FIG. 7;

FIG. 11 is a left side elevational view of FIG. 7;

FIG. 12 is a top, front and side perspective view of the inflatable seat cushion with the front and side flaps unfolded;

FIG. 13 is a front elevational view of FIG. 12;

FIG. 14 is a right side elevational view of FIG. 12; and,

FIG. 15 is a left side elevational view of FIG. 12.

All broken lines are for illustrative purposes only, and form no part of the claimed design.

The views in the drawings are shown drawn on different scales.

1 Claim, 5 Drawing Sheets

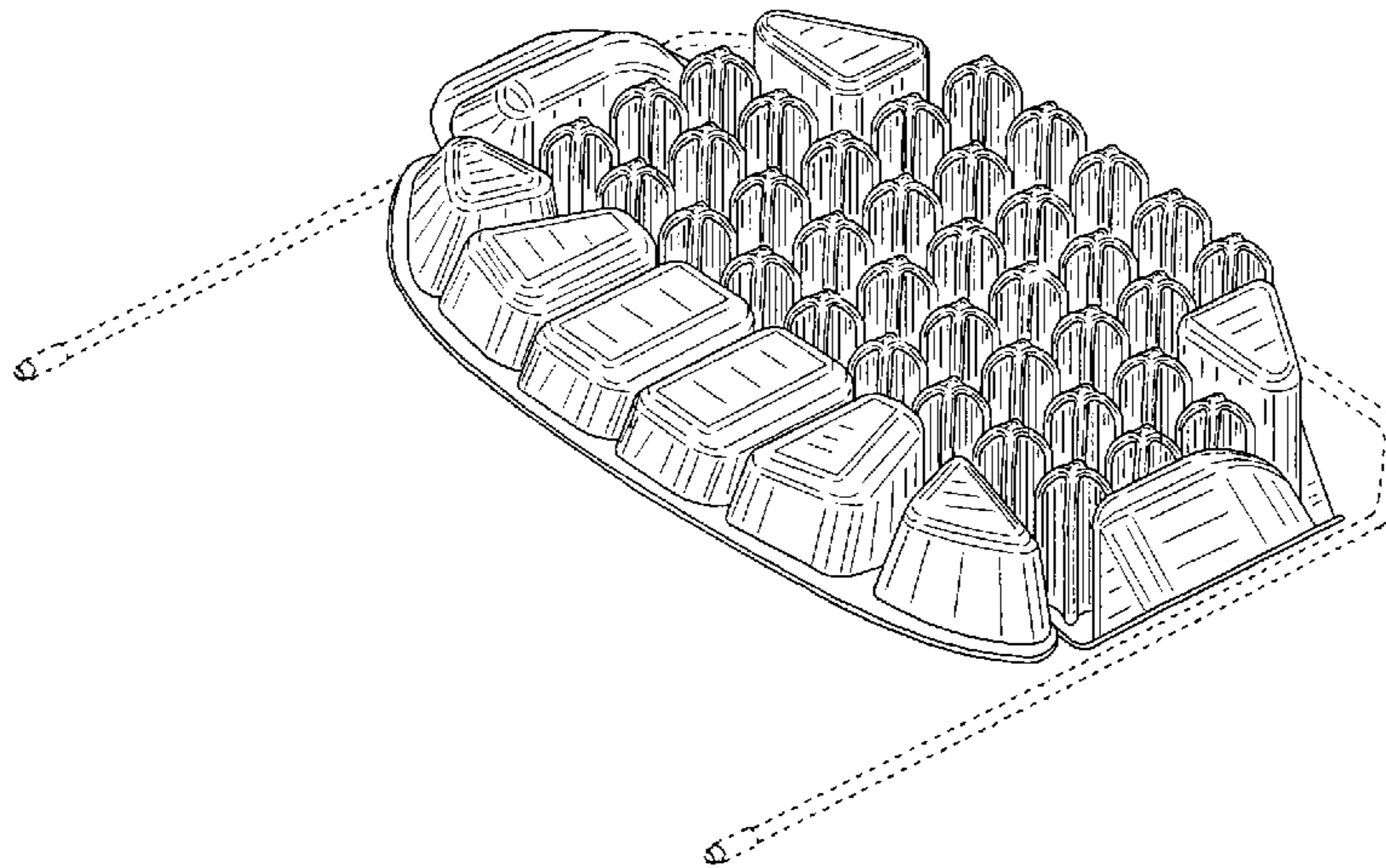

US D647,344 S

Page 2

U.S. PATENT DOCUMENTS

D367,199	S	2/1996	Graebe			
D368,399	S *	4/1996	Buffon	D6/500	
5,502,855	A	4/1996	Graebe			
5,533,220	A *	7/1996	Sebag et al.	5/654	
5,551,107	A *	9/1996	Graebe	5/654	
5,561,875	A *	10/1996	Graebe	5/423	
5,596,781	A	1/1997	Graebe			
D386,035	S	11/1997	Matsler et al.			
5,689,845	A *	11/1997	Sobieralski	5/654	
D389,692	S	1/1998	Graebe et al.			
D389,702	S *	1/1998	Graebe et al.	D6/601	
D391,110	S	2/1998	Graebe et al.			
5,839,140	A *	11/1998	Wilkerson	5/654	
5,845,352	A *	12/1998	Matsler et al.	5/654	
6,018,832	A *	2/2000	Graebe	5/654	
D439,098	S	3/2001	Matsler et al.			
D463,701	S	10/2002	Borcherding et al.			
6,502,263	B1 *	1/2003	Rowley et al.	5/654	
6,598,251	B2 *	7/2003	Habboub et al.	5/654	
6,623,080	B2 *	9/2003	Clapper	297/452.41	
6,715,171	B2 *	4/2004	Grabe	5/644	
6,901,617	B2	6/2005	Sprouse, II et al.			
D508,812	S *	8/2005	Kuo	D6/601	
7,350,251	B2	4/2008	Fraser et al.			
7,373,678	B2	5/2008	Hetzel et al.			
7,424,761	B1	9/2008	Graebe			
7,681,264	B2	3/2010	Graebe			
7,681,265	B2 *	3/2010	Fraser	5/654	
D617,131	S	6/2010	Sprouse, II			
2003/0205920	A1 *	11/2003	Sprouse et al.	297/219.1	
2005/0151410	A1 *	7/2005	Sprouse, II	297/452.41	
2008/0079306	A1	4/2008	Whelan et al.			

* cited by examiner

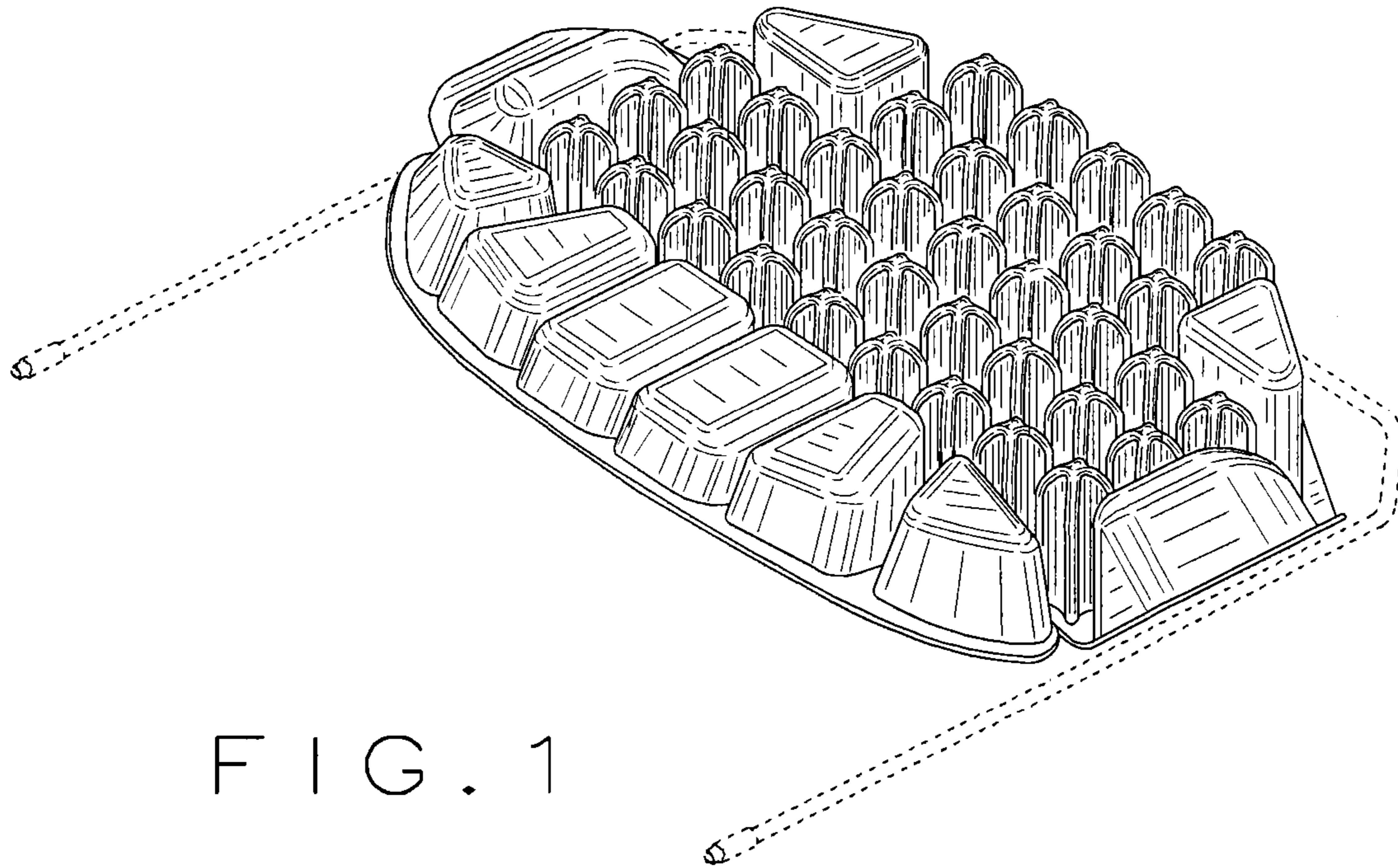

FIG. 1

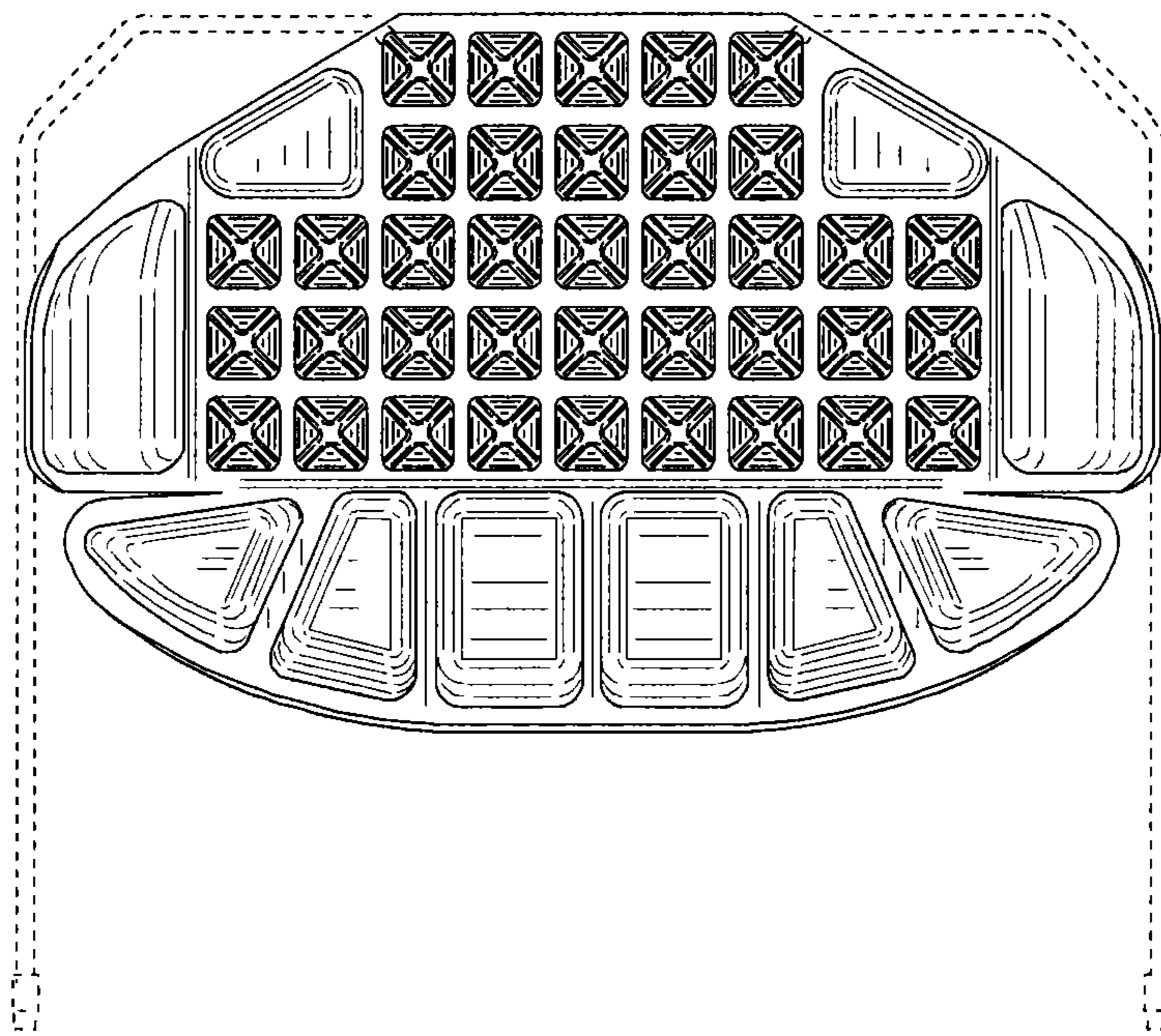

FIG. 2

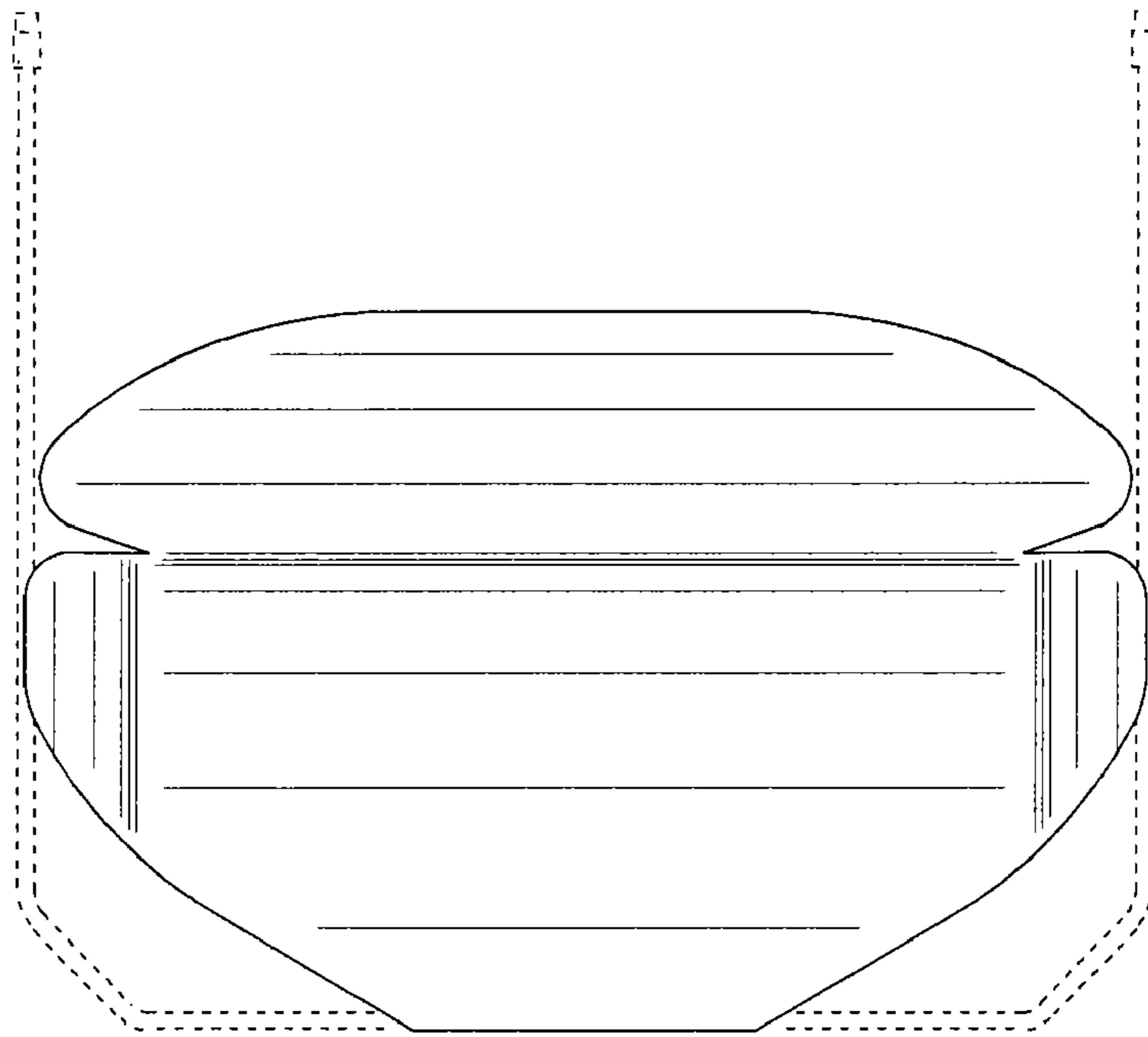

FIG. 3

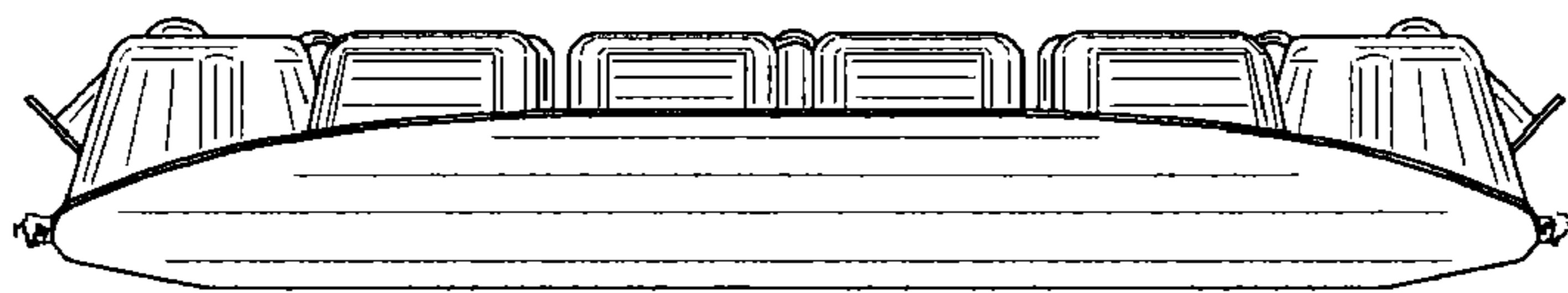

FIG. 4

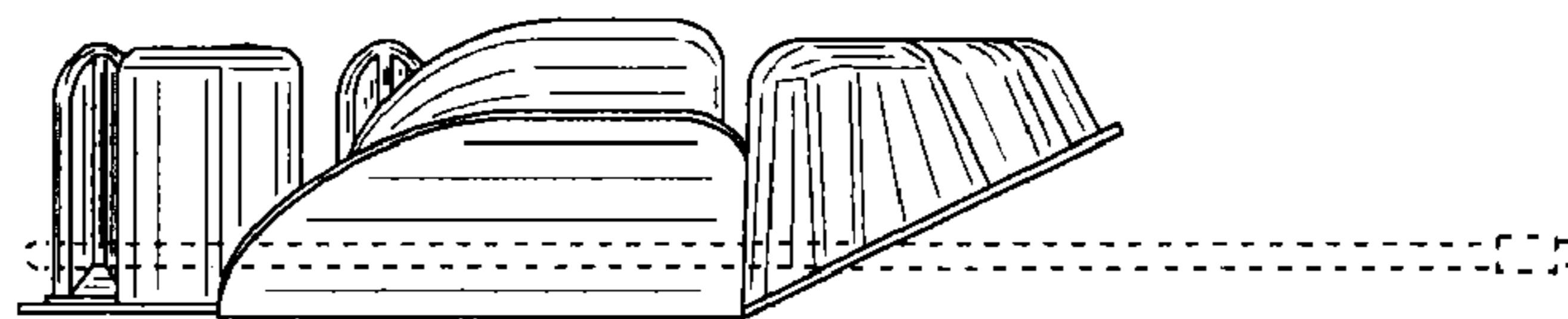

FIG. 5

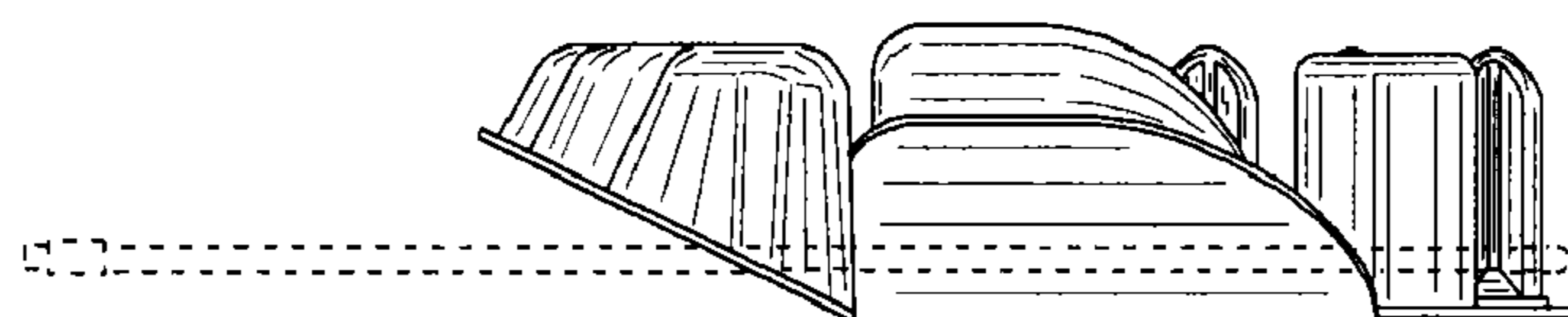

FIG. 6

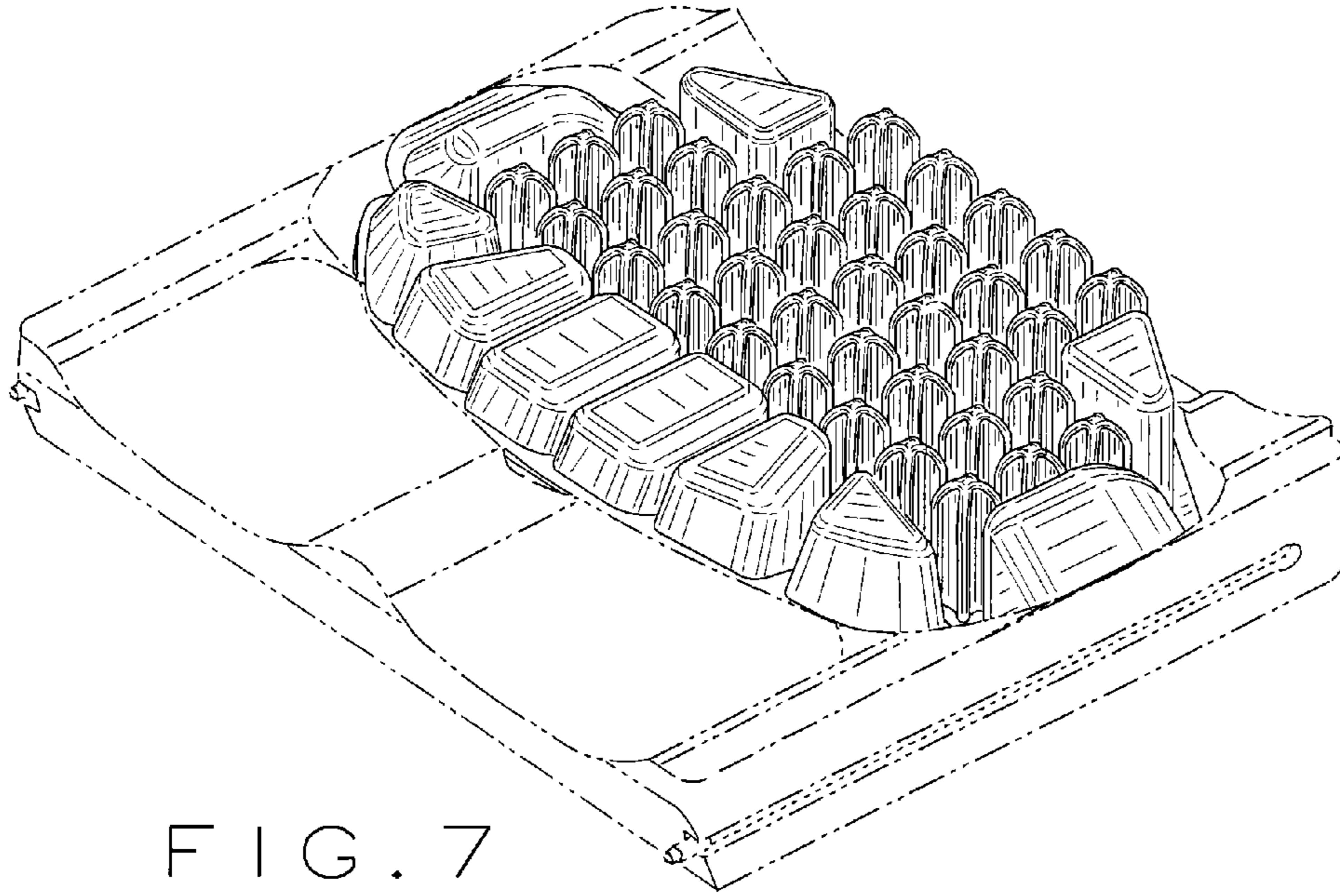

FIG. 7

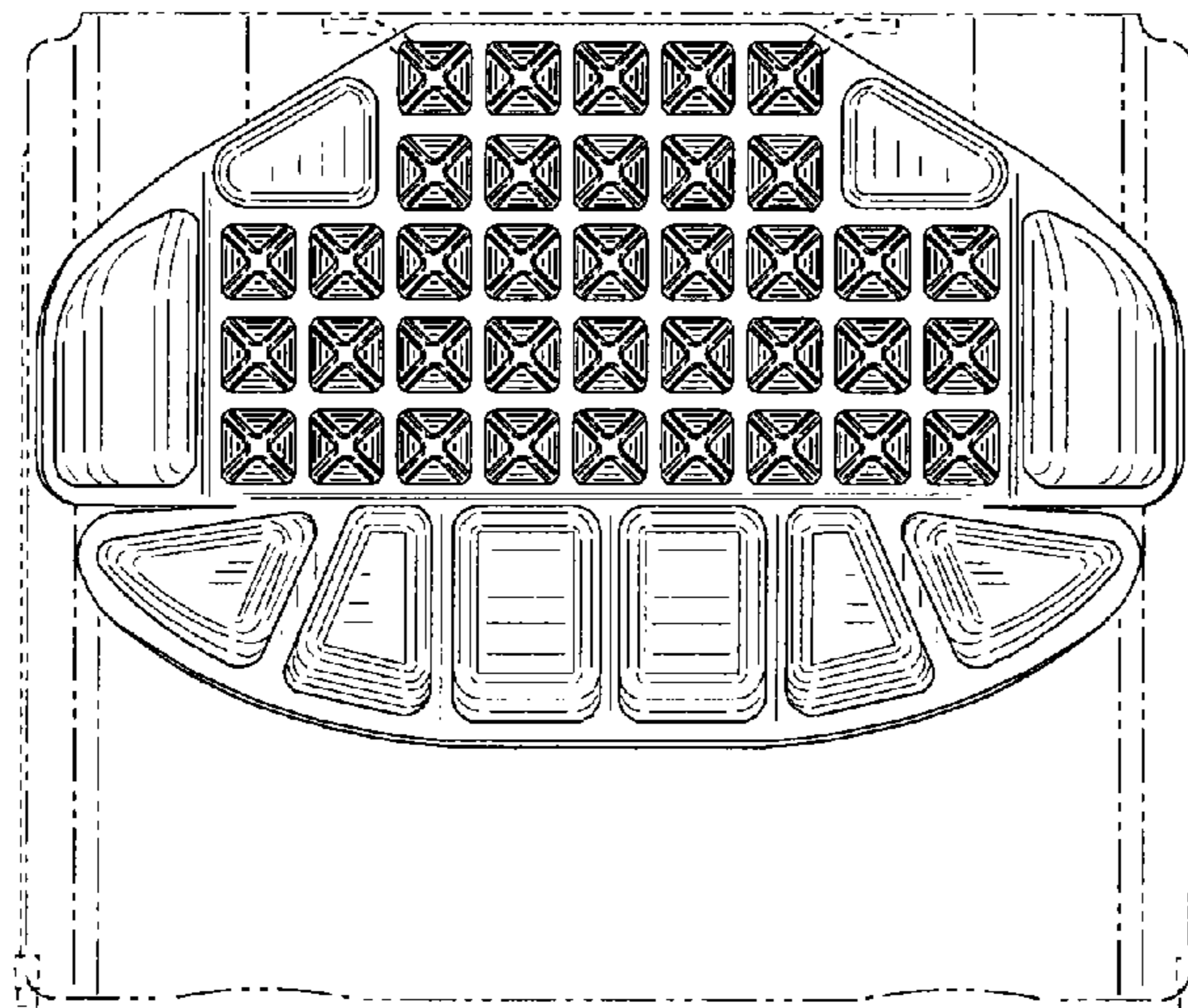

FIG. 8

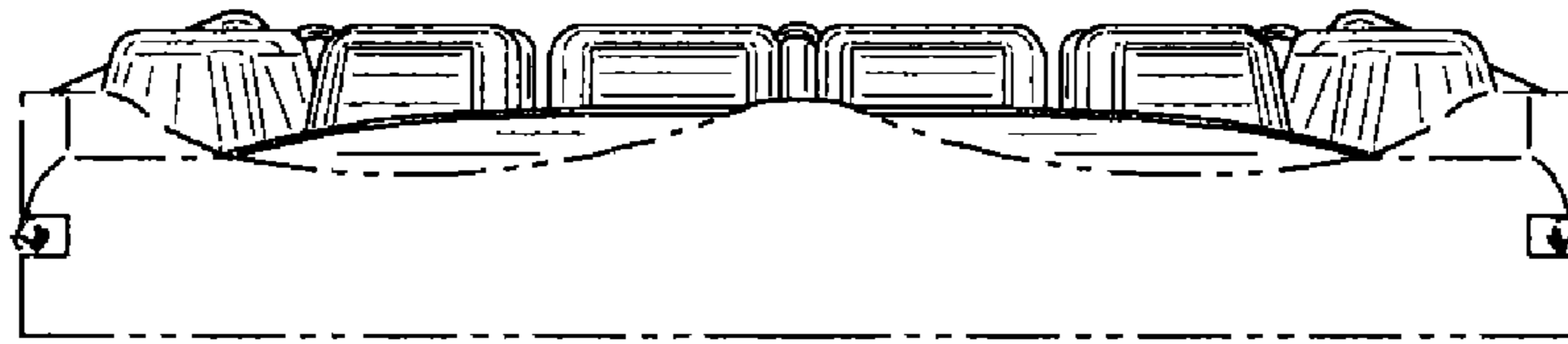

FIG. 9

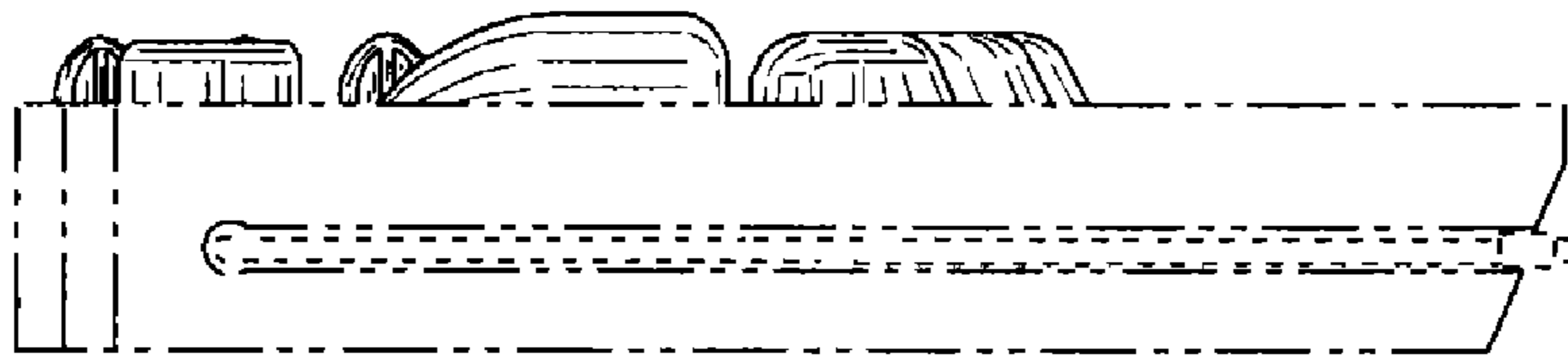

FIG. 10



FIG. 11

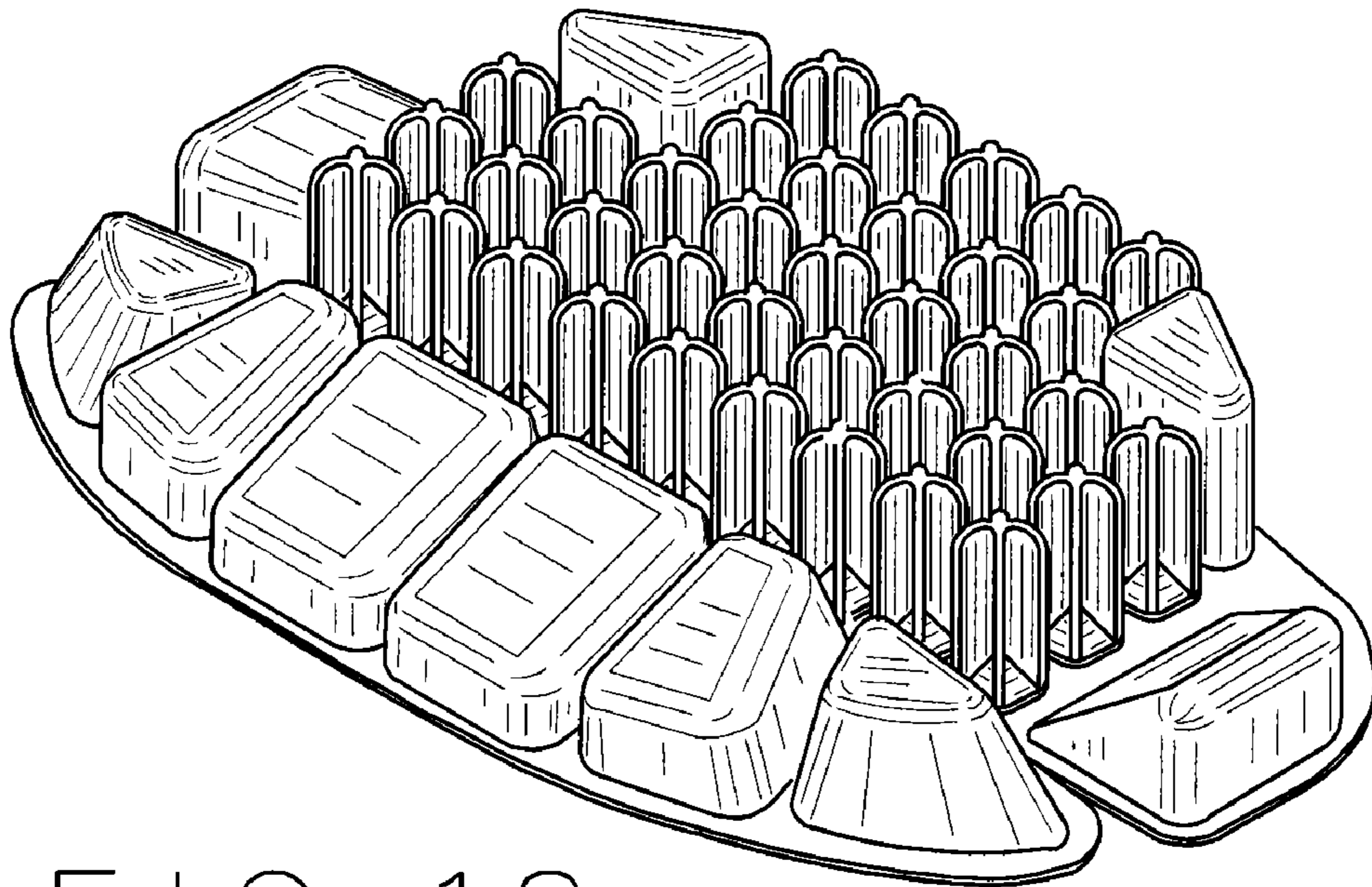

FIG. 12

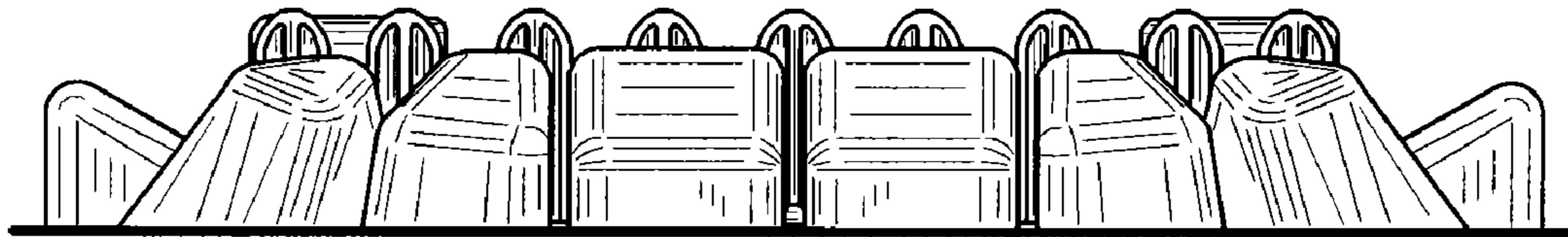

FIG. 13

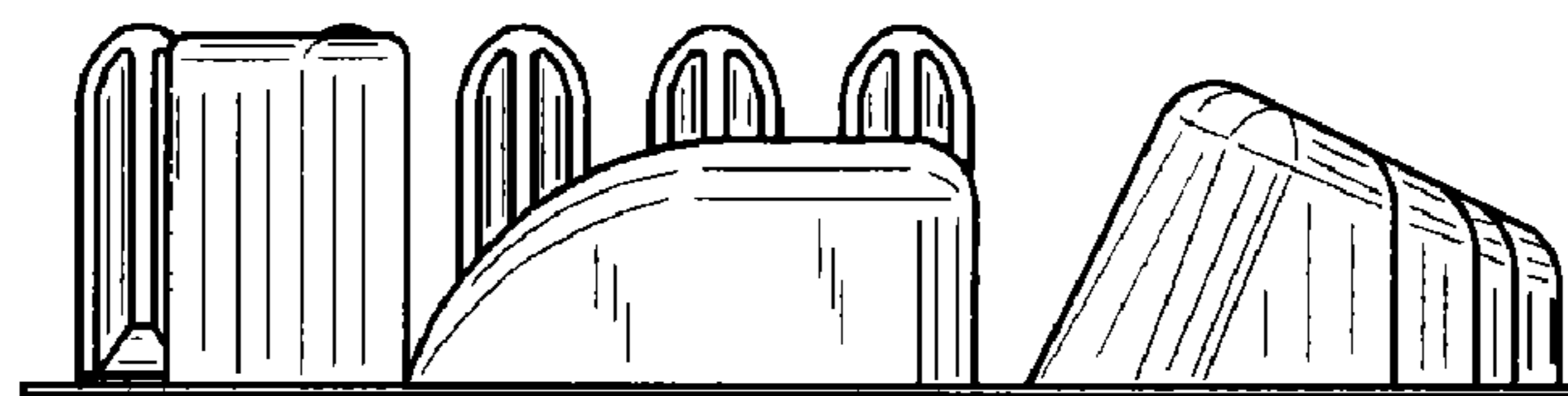

FIG. 14

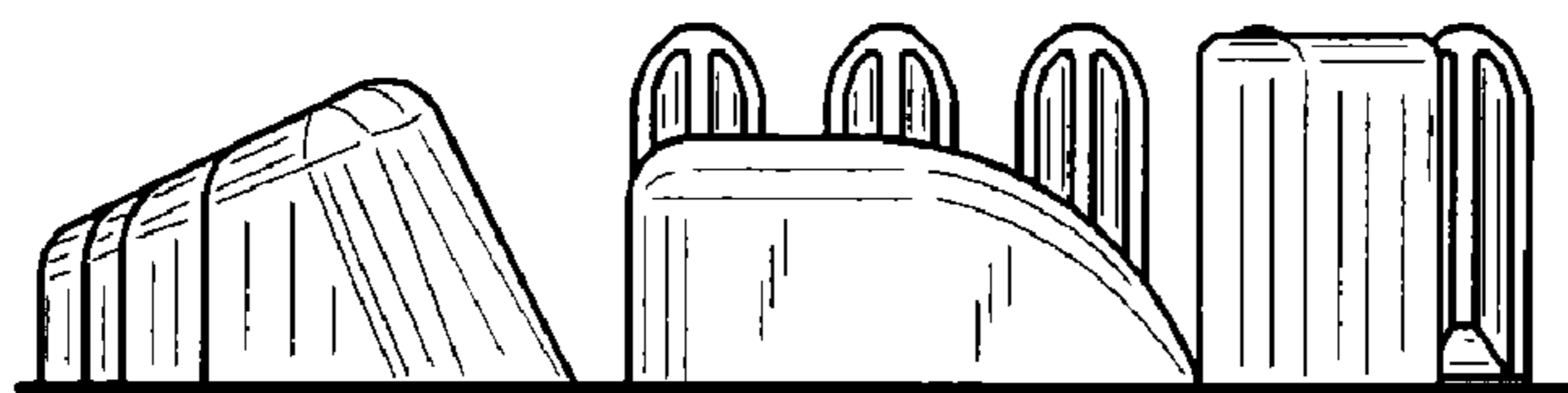

FIG. 15