



US00D647341S

(12) **United States Design Patent**
Micinilio

(10) **Patent No.:** **US D647,341 S**

(45) **Date of Patent:** **** Oct. 25, 2011**

(54) **SAFETY RAZOR HOLDER**

(75) Inventor: **Gregg A Micinilio**, Trumbull, CT (US)

(73) Assignee: **Eveready Battery Company, inc.**, St. Louis, MO (US)

(**) Term: **14 Years**

(21) Appl. No.: **29/390,120**

(22) Filed: **Apr. 20, 2011**

(51) **LOC (9) Cl.** **28-03**

(52) **U.S. Cl.** **D6/526**

(58) **Field of Classification Search** D6/526,
D6/524, 540; 211/13.1, 70.6, 87.01, 89.01;
248/200, 205.5, 309.1, 314, 127, 176.1
See application file for complete search history.

(56) **References Cited**

U.S. PATENT DOCUMENTS

D251,970 S *	5/1979	Fujita	D6/526
D300,406 S *	3/1989	Bordian	D6/526
D335,990 S *	6/1993	Lizanetz et al.	D6/526
D369,049 S *	4/1996	Scaglione	D6/526
D370,375 S *	6/1996	Murgida et al.	D6/526
D423,845 S	5/2000	Coffin et al.	
D464,222 S	10/2002	Coffin et al.	

D547,582 S *	7/2007	Lukan	D6/526
D571,591 S *	6/2008	Ramm et al.	D6/526
D574,651 S	8/2008	Wonderley et al.	
D588,387 S	3/2009	Micinilio et al.	
D625,130 S *	10/2010	Szczepanowski et al.	D6/526
D632,516 S	2/2011	Schulz et al.	

* cited by examiner

Primary Examiner — Brian N Vinson

(74) *Attorney, Agent, or Firm* — Energizer Personal Care, LLC

(57) **CLAIM**

I claim the ornamental design for the safety razor holder, as shown and described.

DESCRIPTION

FIG. 1 is an upper perspective view of the safety razor holder. FIG. 2 is a lower perspective view thereof. FIG. 3 is a front view thereof. FIG. 4 is a bottom view thereof. FIG. 5 is a top view thereof. FIG. 6 is a rear view thereof. FIG. 7 is a right side view of FIG. 3; and, FIG. 8 is a left side view of FIG. 3. The broken lines in the figures depict environmental subject matter only and form no part of the claimed design.

1 Claim, 5 Drawing Sheets

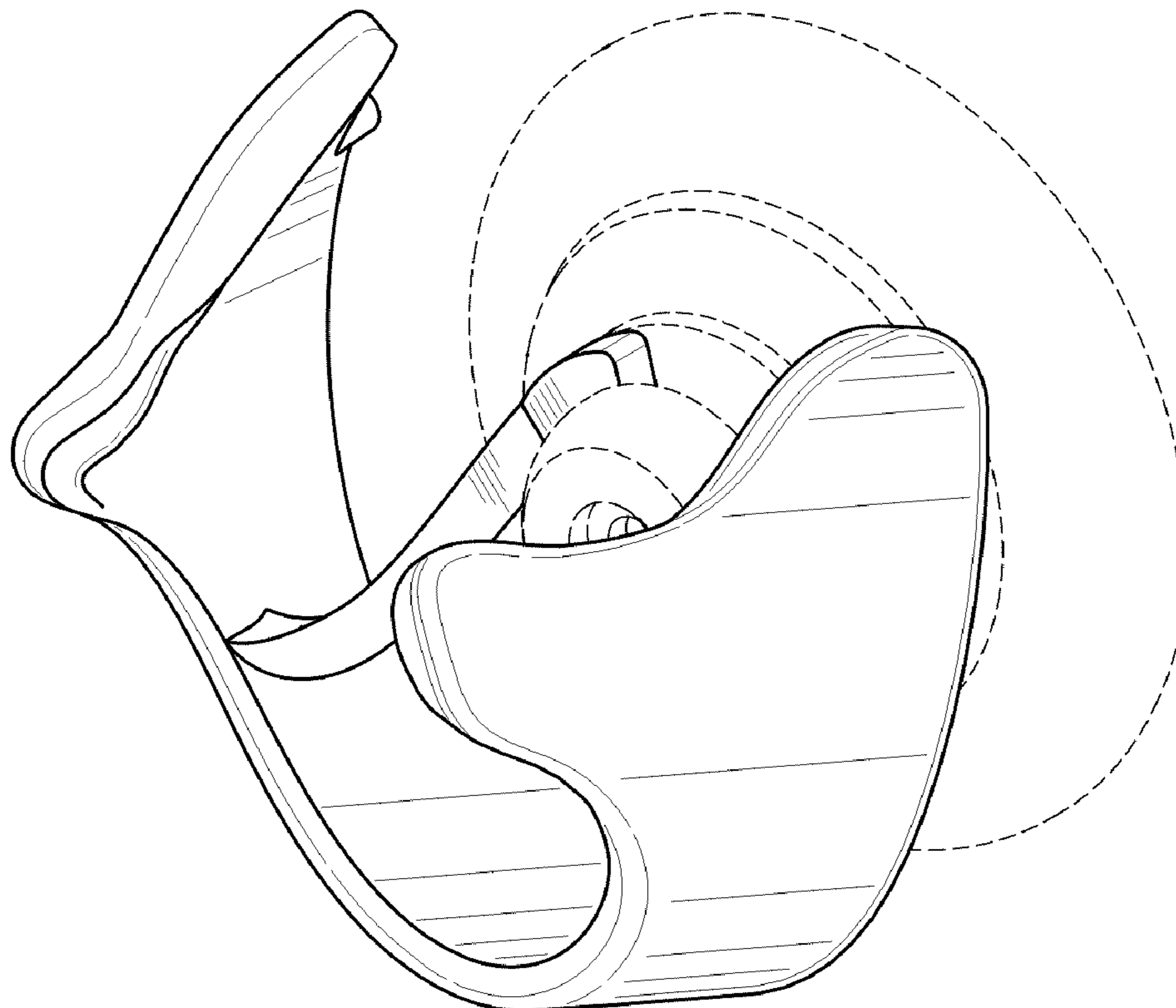

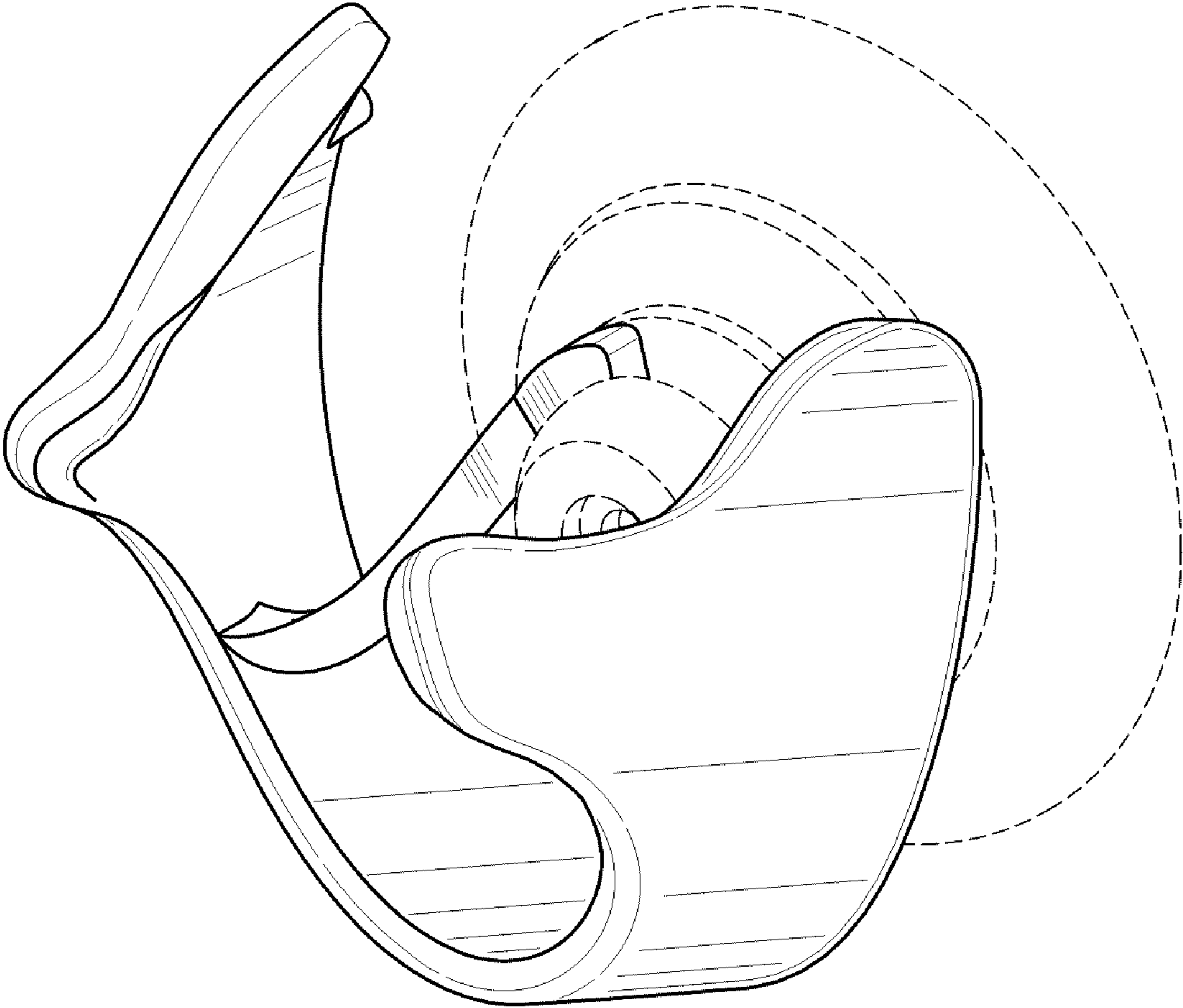

FIG. 1

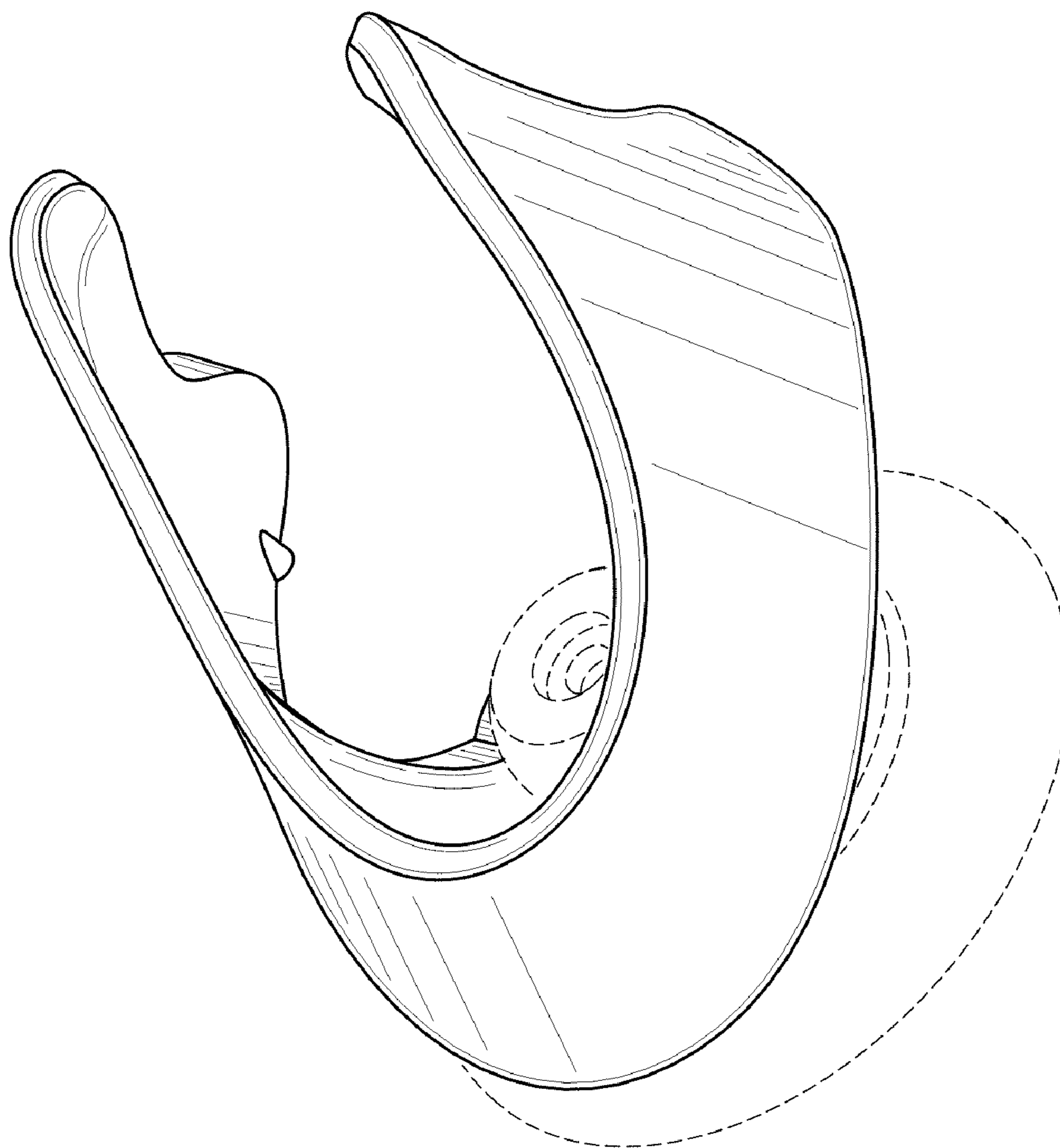

FIG. 2

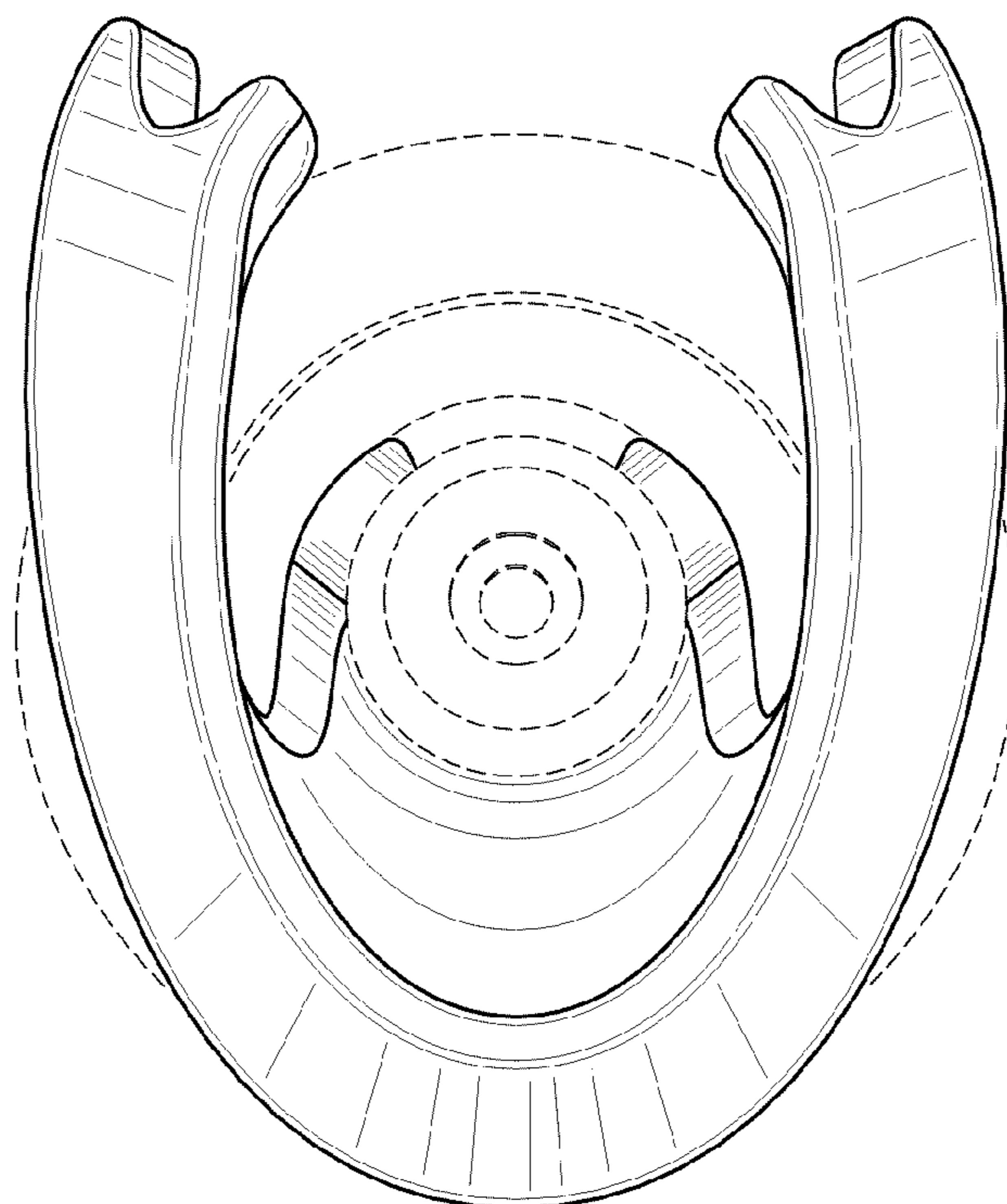

FIG. 3

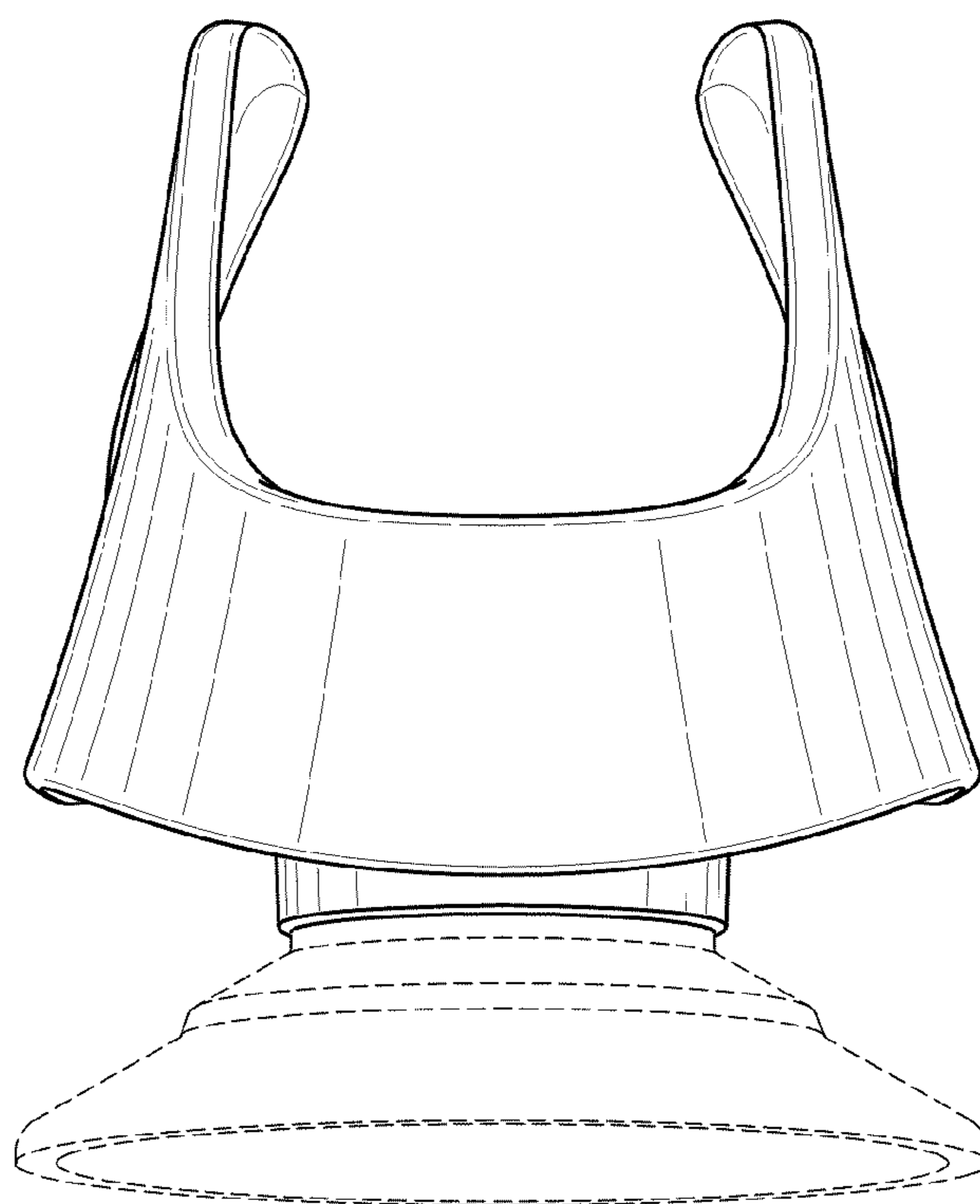

FIG. 4

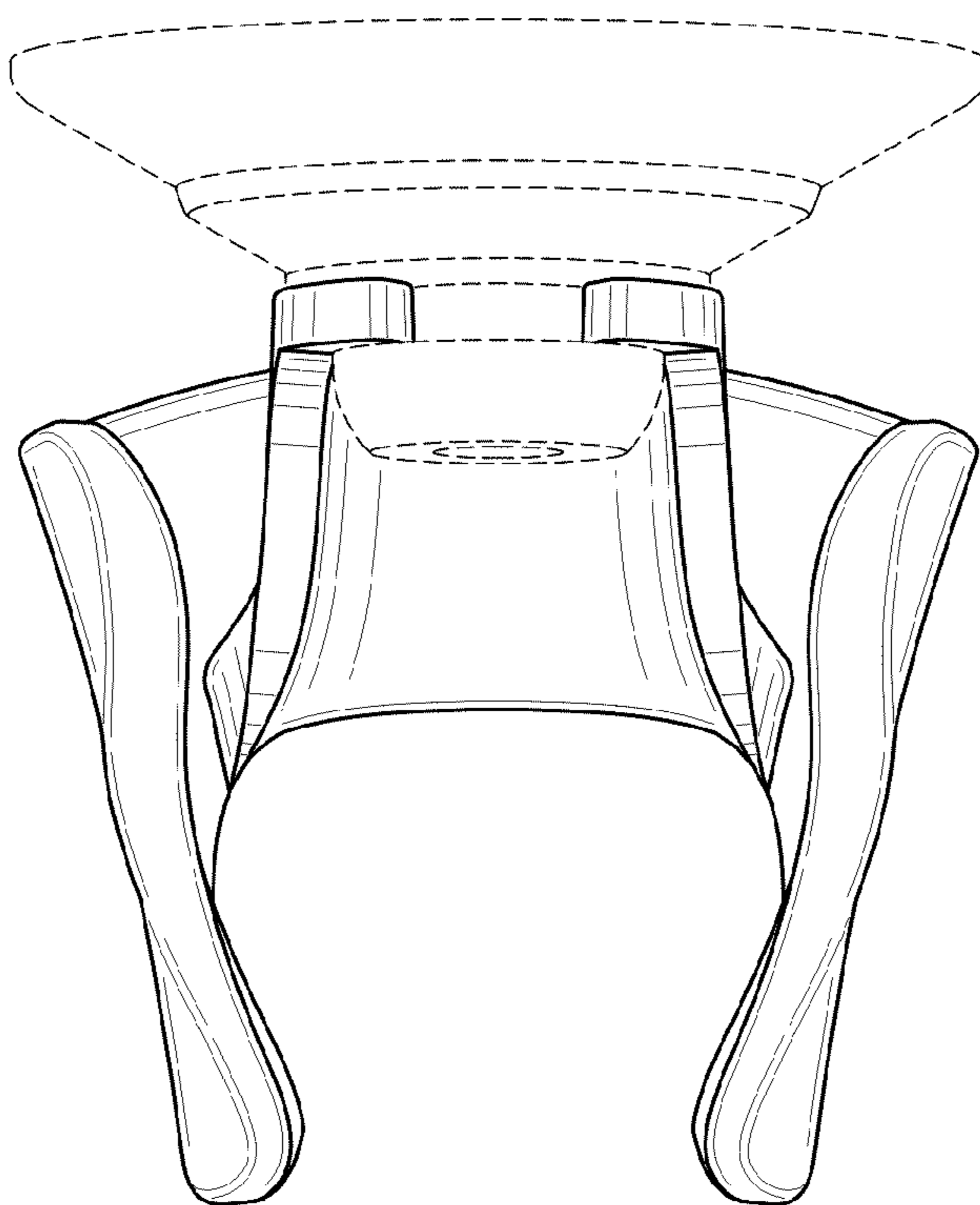

FIG. 5

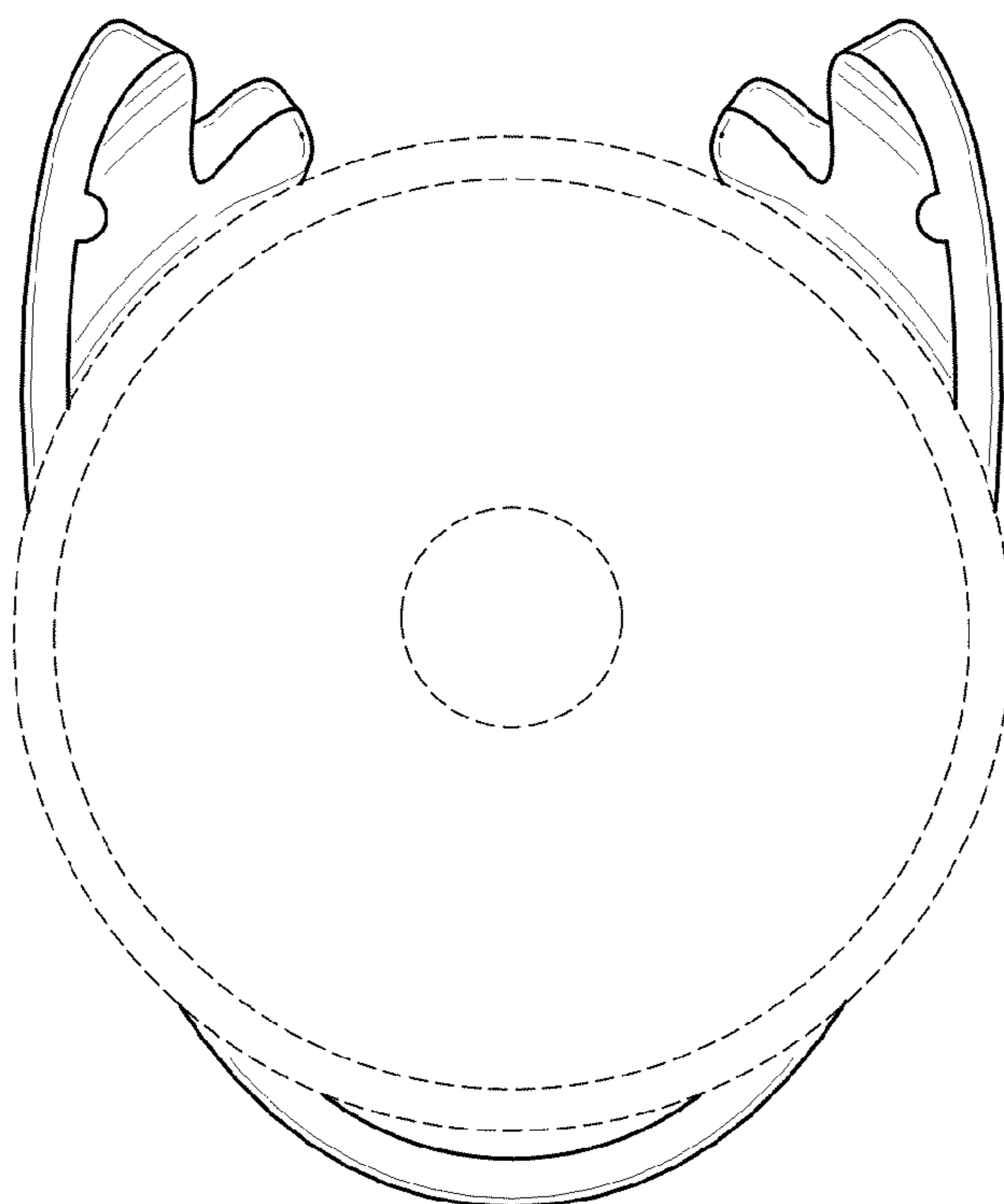

FIG. 6

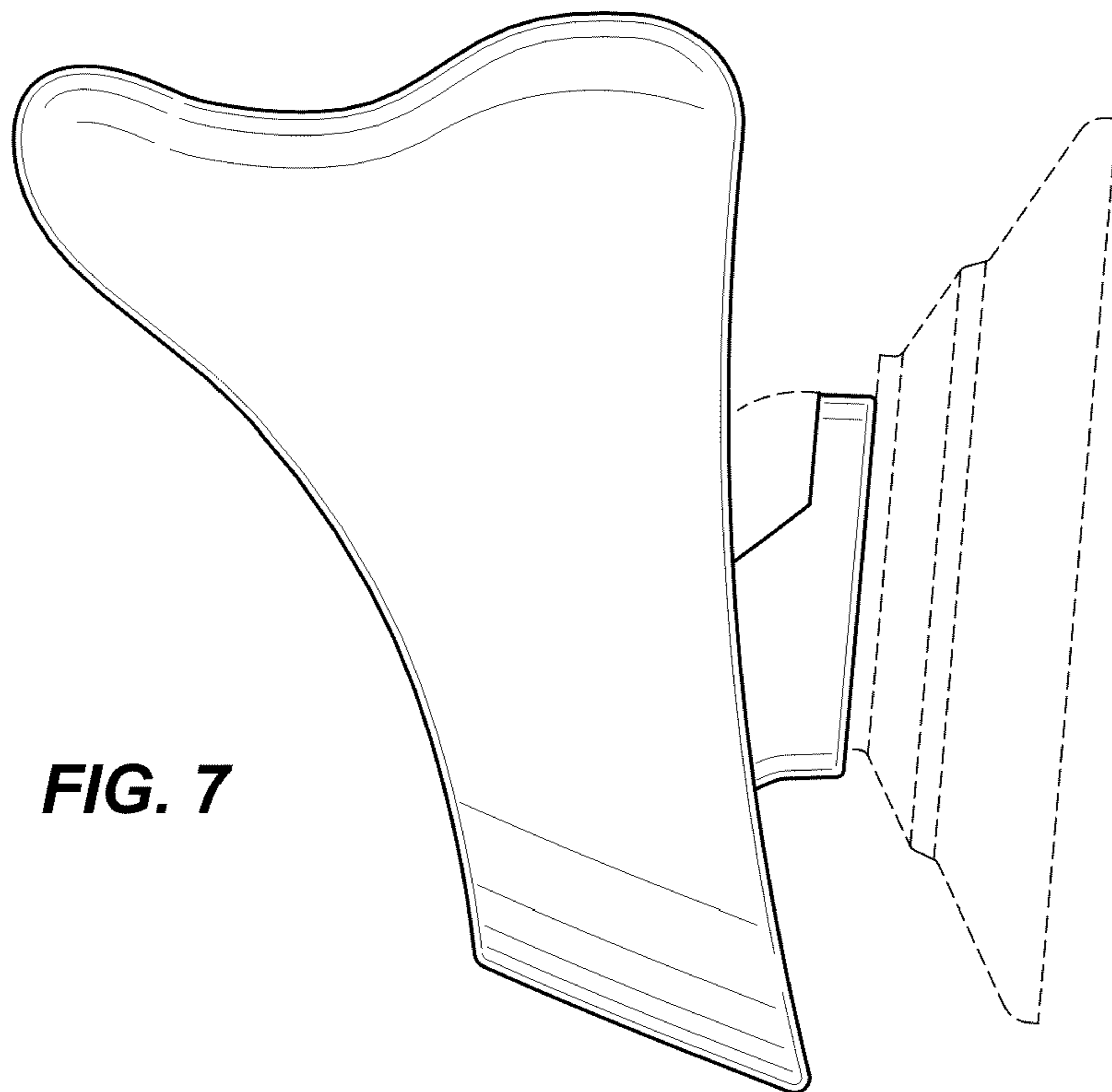

FIG. 7

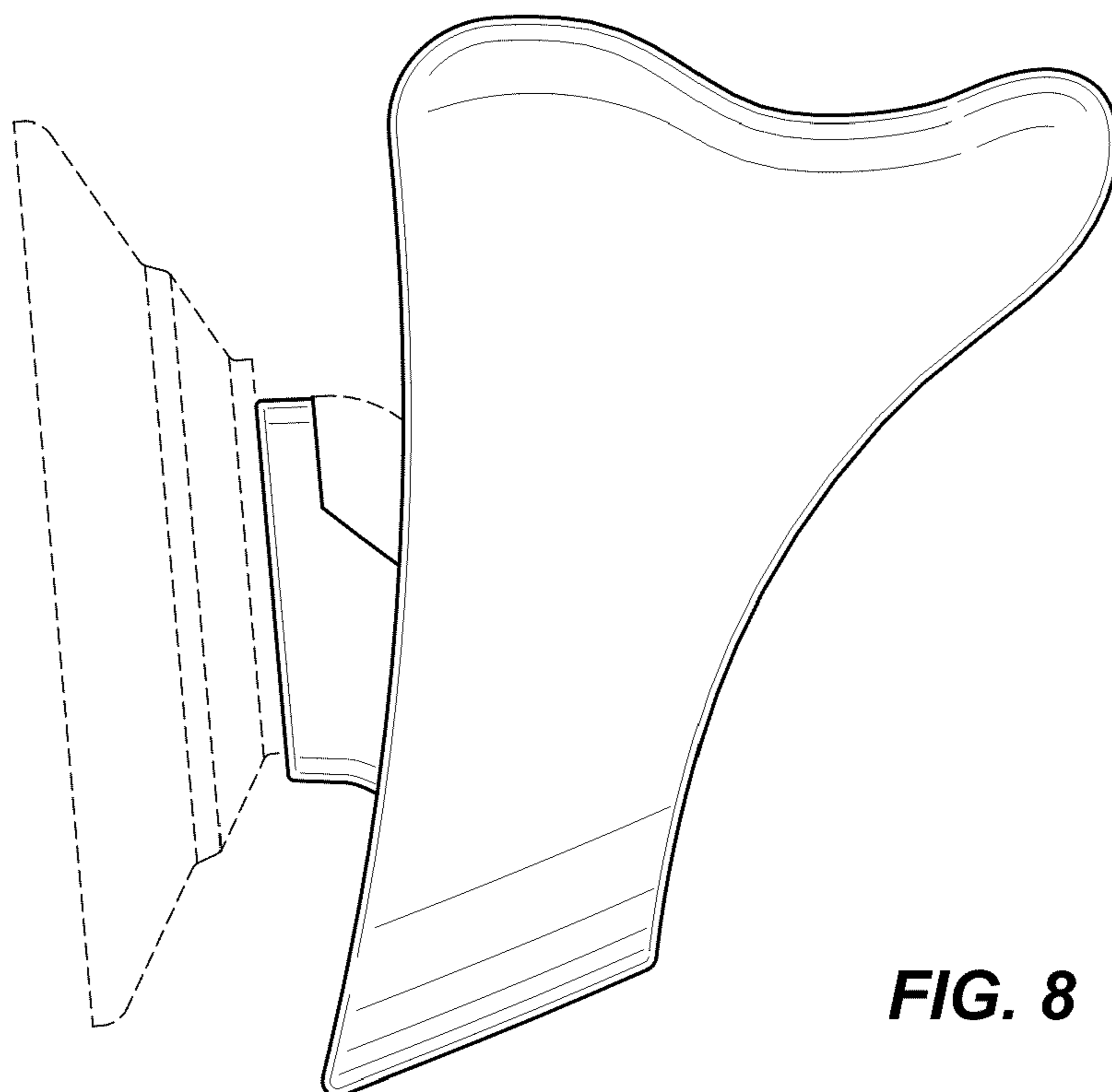

FIG. 8