



US00D647328S

(12) **United States Design Patent**
Levin et al.

(10) **Patent No.:** **US D647,328 S**
(45) **Date of Patent:** **** Oct. 25, 2011**

(54) **SCARF AND BELT RACK**

(74) *Attorney, Agent, or Firm* — William Nitkin

(75) Inventors: **Gregg M. Levin**, Boston, MA (US);
Guang Yu Gao, Malden, MA (US); **Roy A. Rudder**,
Dorchester, MA (US); **Michael C. Kowalski**, Boston, MA (US)

(57) **CLAIM**
The ornamental design for a scarf and belt rack, as shown and described.

(73) Assignee: **Perfect Curve, Inc.**, Boston, MA (US)

(**) Term: **14 Years**

DESCRIPTION

(21) Appl. No.: **29/310,725**

(22) Filed: **Sep. 8, 2008**

(51) **LOC (9) Cl.** **06-04**

(52) **U.S. Cl.** **D6/468**

(58) **Field of Classification Search** D6/396,
D6/405, 407, 455, 457-464, 466-468, 474,
D6/476, 479, 509, 514, 315, 317, 320, 324,
D6/410, 411, 512, 310, 418, 553, 449; 211/13.1,
211/41.1, 49.1, 50, 126.2, 126.3, 134, 85.3,
211/85.6, 85.7, 18, 71.01, 187, 86.01, 60.1,
211/96, 113, 87.01; 108/147.11, 59, 92,
108/115; 223/85, 91-93, 97-98; 206/113,
206/85.3, 87.01; 248/214, 309.1

See application file for complete search history.

(56) **References Cited**

U.S. PATENT DOCUMENTS

D202,676 S *	10/1965	Weitzman	D6/468
D295,344 S *	4/1988	Pryor et al.	D6/323
D378,475 S *	3/1997	Brown	D6/317
D401,084 S *	11/1998	Martin	D6/474
D404,577 S *	1/1999	Schildkraut	D6/315
D404,578 S *	1/1999	Prince	D6/315
D407,564 S *	4/1999	Wilcox	D6/315
D414,967 S *	10/1999	Richter	D6/513
D444,954 S *	7/2001	Umbarger	D6/320
D469,262 S *	1/2003	Umbarger	D6/320
D573,811 S *	7/2008	Weigand	D6/468
D580,661 S *	11/2008	Belokin	D6/315
D612,618 S *	3/2010	Levin et al.	D6/315

* cited by examiner

Primary Examiner — Caron D Veynar

Assistant Examiner — Abraham Bahta

FIG. 1 is an enlarged front perspective view of a single clip mounted on a strap, being one of a plurality of identical clips used in our scarf and belt rack design as described below;
 FIG. 2 is an enlarged bottom plan view of the design of this invention;
 FIG. 3 is an enlarged top plan view of the design of this invention;
 FIG. 4 is an enlarged left side view of a single clip mounted on a strap;
 FIG. 5 is an enlarged front elevational view of a single clip mounted on a strap;
 FIG. 6 is an enlarged rear view of a single clip mounted on a strap;
 FIG. 7A is a front perspective view of the highest section of ten continuous sections of the scarf and belt rack showing our new design;
 FIG. 7B is a front perspective view of the next lower section being a continuation of the section of FIG. 7A;
 FIG. 7C is a front perspective view of the next lower section being a continuation of the section of FIG. 7B;
 FIG. 7D is a front perspective view of the next lower section being a continuation of the section of FIG. 7C;
 FIG. 7E is a front perspective view of the next lower section being a continuation of the section of FIG. 7D;
 FIG. 7F is a front perspective view of the next lower section being a continuation of the section of FIG. 7E;
 FIG. 7G is a front perspective view of the next lower section being a continuation of the section of FIG. 7F;
 FIG. 7H is a front perspective view of the next lower section being a continuation of the section of FIG. 7G;
 FIG. 7I is a front perspective view of the next lower section being a continuation of the section of FIG. 7H;
 FIG. 7J is a front perspective view of the lowest section being a continuation of the section of FIG. 7I;

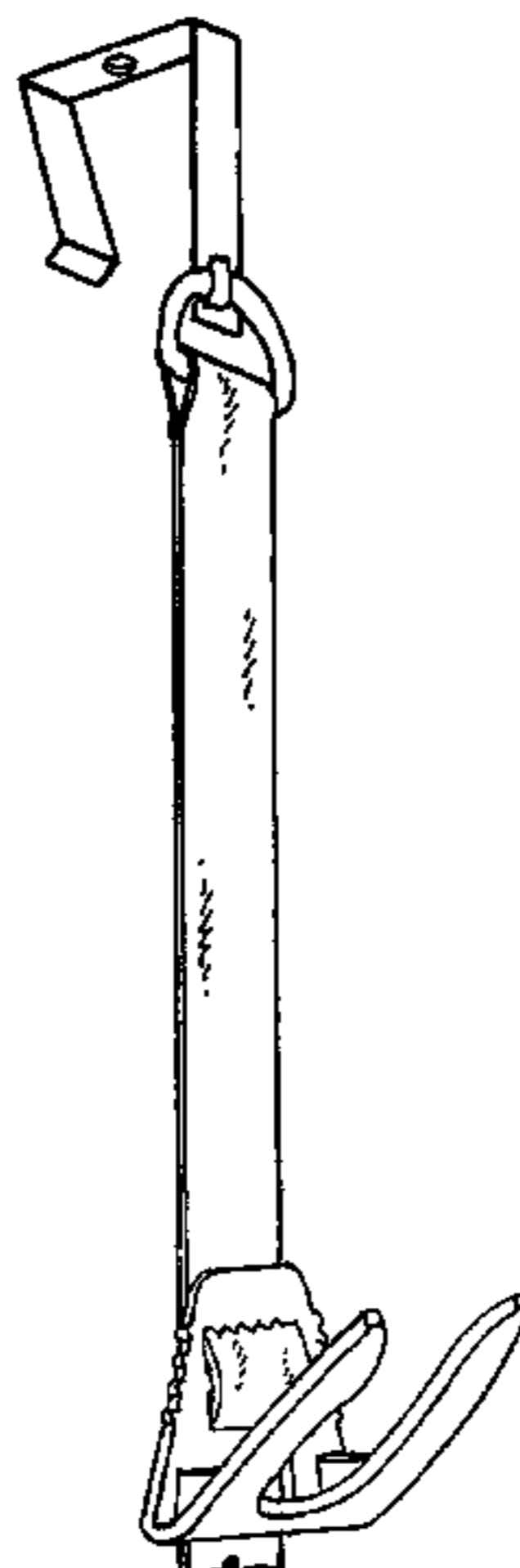

FIG. 8A is a rear perspective view of the highest section of ten continuous sections of the scarf and belt rack showing our new design;

FIG. 8B is a rear perspective view of the next lower section being a continuation of the section of FIG. 8A;

FIG. 8C is a rear perspective view of the next lower section being a continuation of the section of FIG. 8B;

FIG. 8D is a rear perspective view of the next lower section being a continuation of the section of FIG. 8C;

FIG. 8E is a rear perspective view of the next lower section being a continuation of the section of FIG. 8D;

FIG. 8F is a rear perspective view of the next lower section being a continuation of the section of FIG. 8E;

FIG. 8G is a rear perspective view of the next lower section being a continuation of the section of FIG. 8F;

FIG. 8H is a rear perspective view of the next lower section being a continuation of the section of FIG. 8G;

FIG. 8I is a rear perspective view of the next lower section being a continuation of the section of FIG. 8H; and,

FIG. 8J is a rear perspective view of the lowest section being a continuation of the section of FIG. 8I.

1 Claim, 22 Drawing Sheets

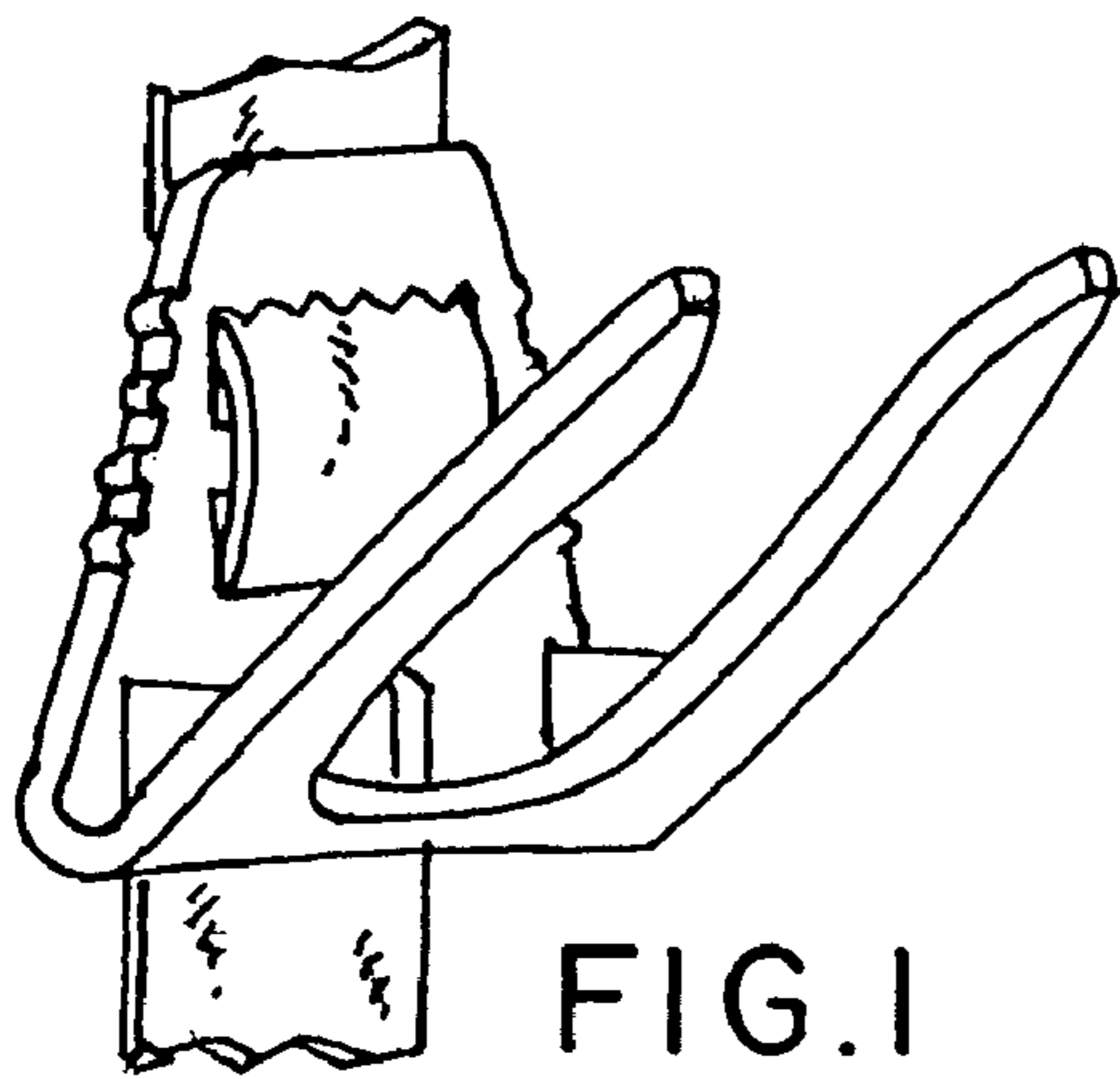

FIG. 1

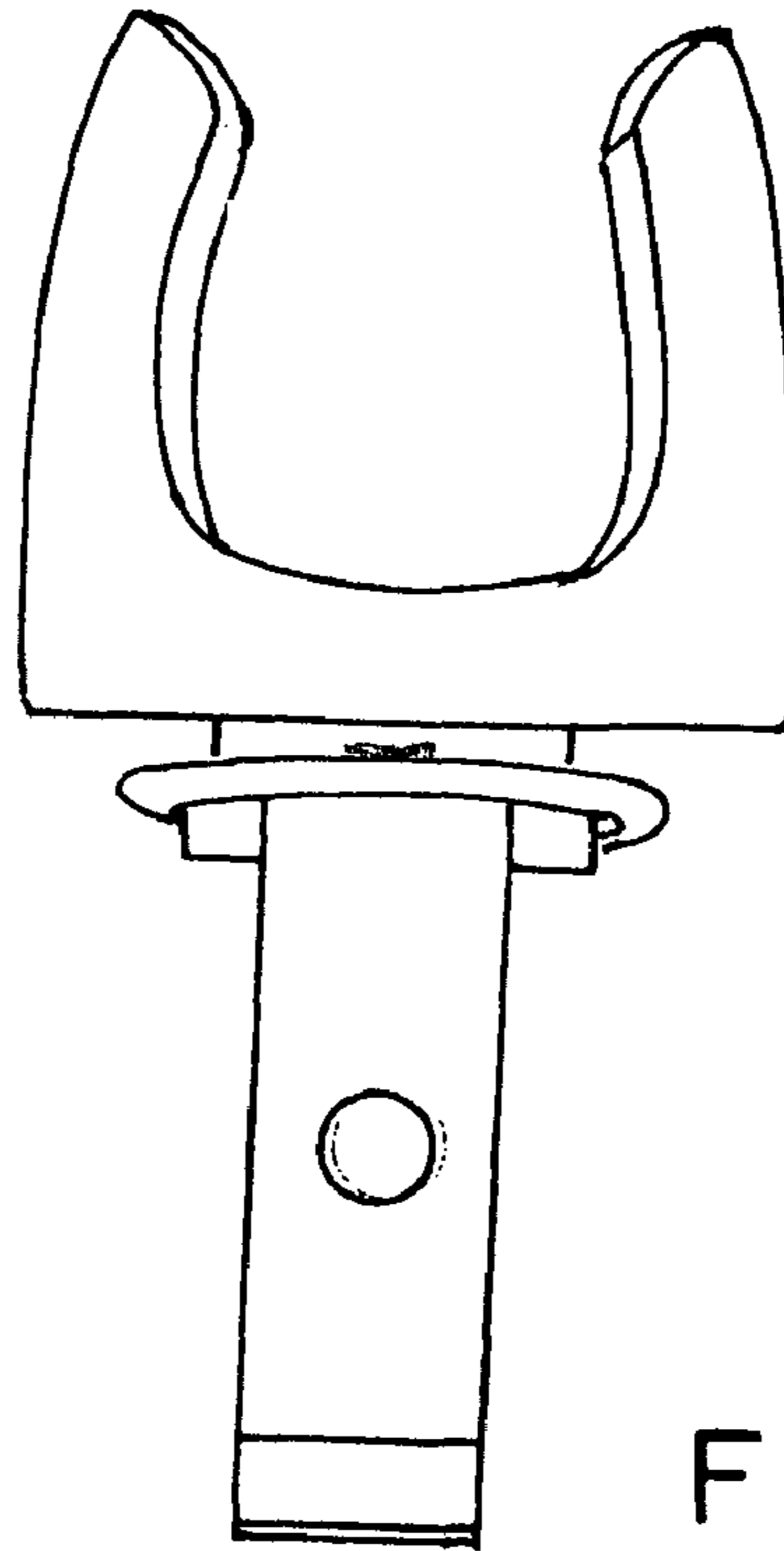

FIG. 3

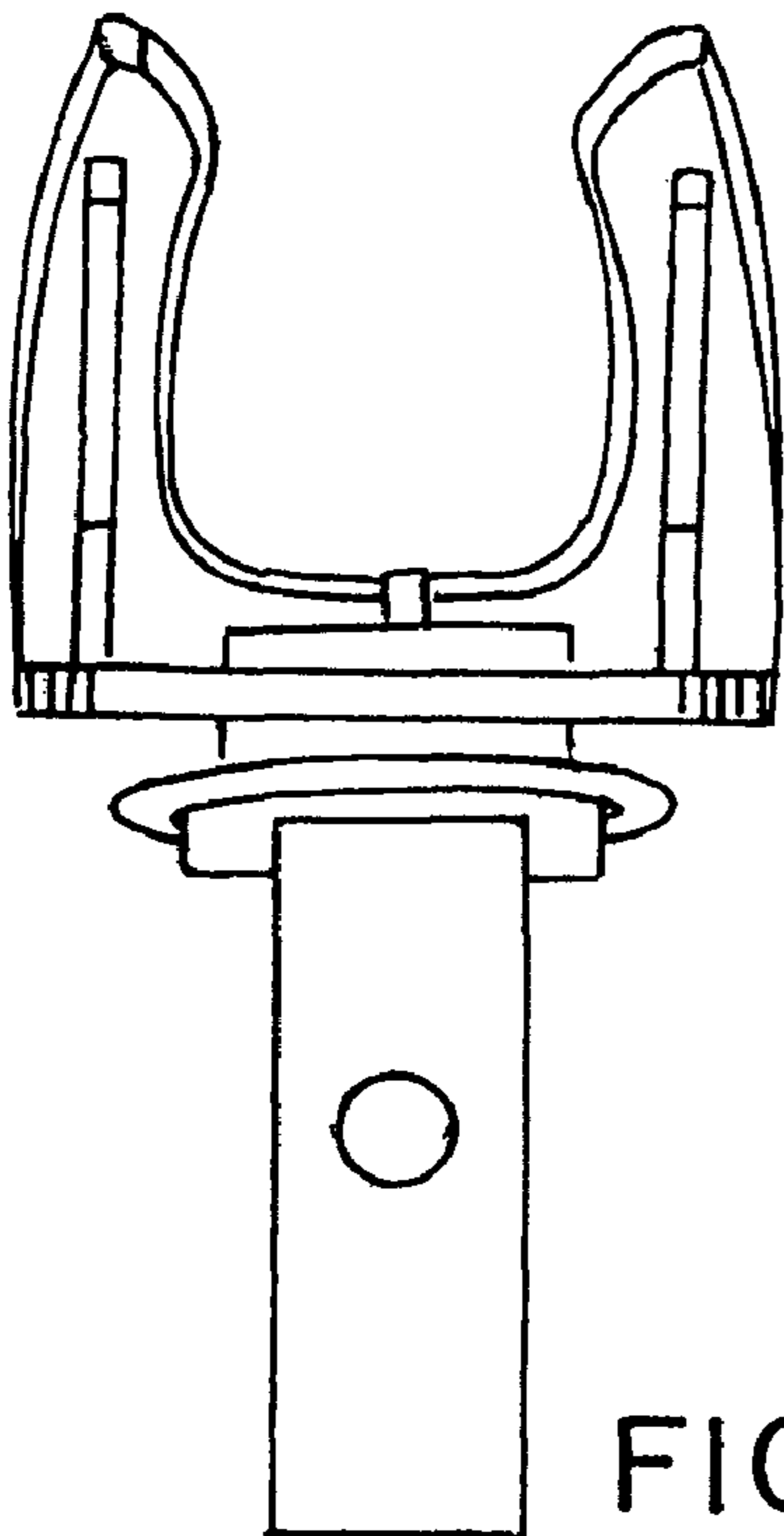

FIG. 2

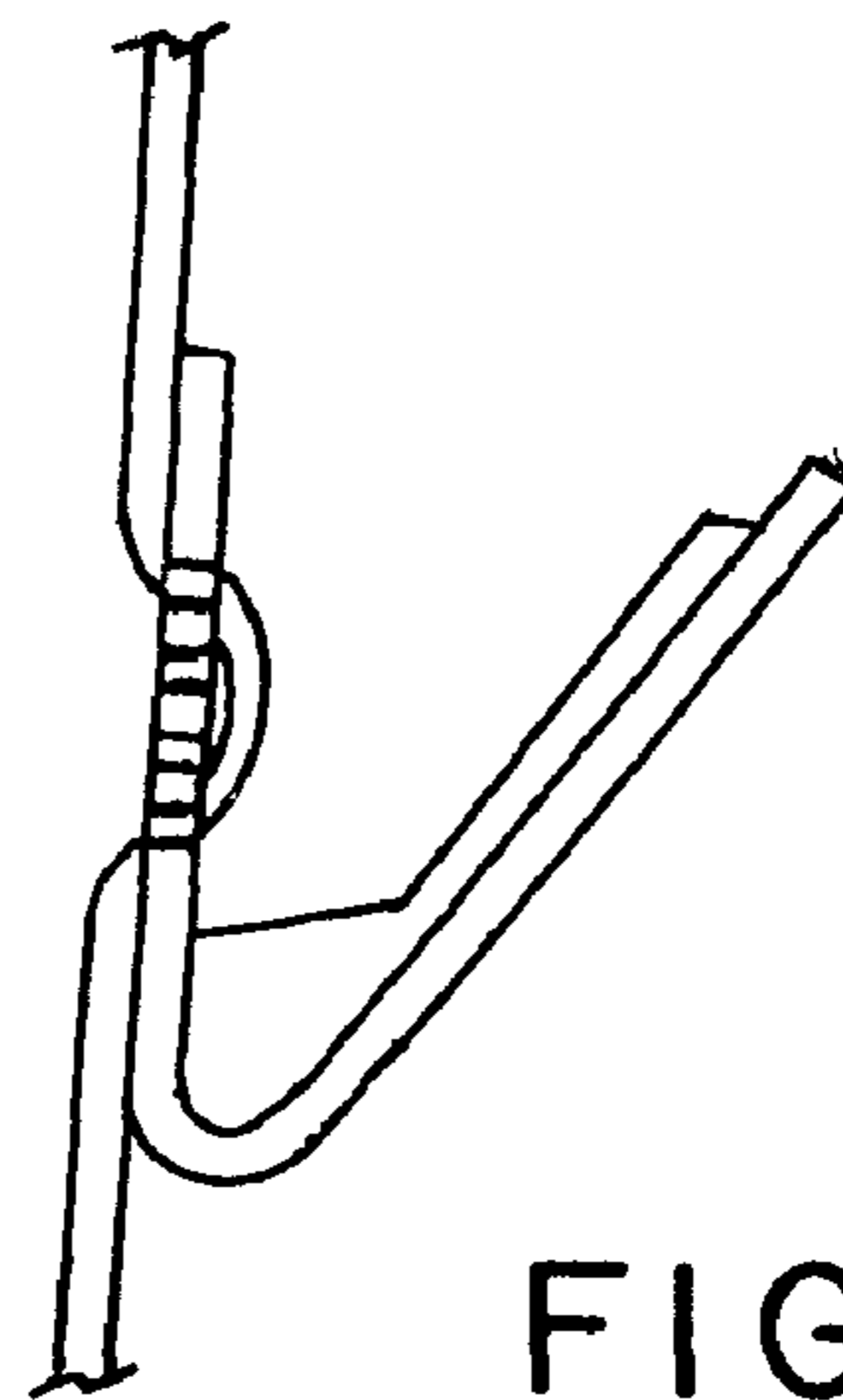

FIG. 4

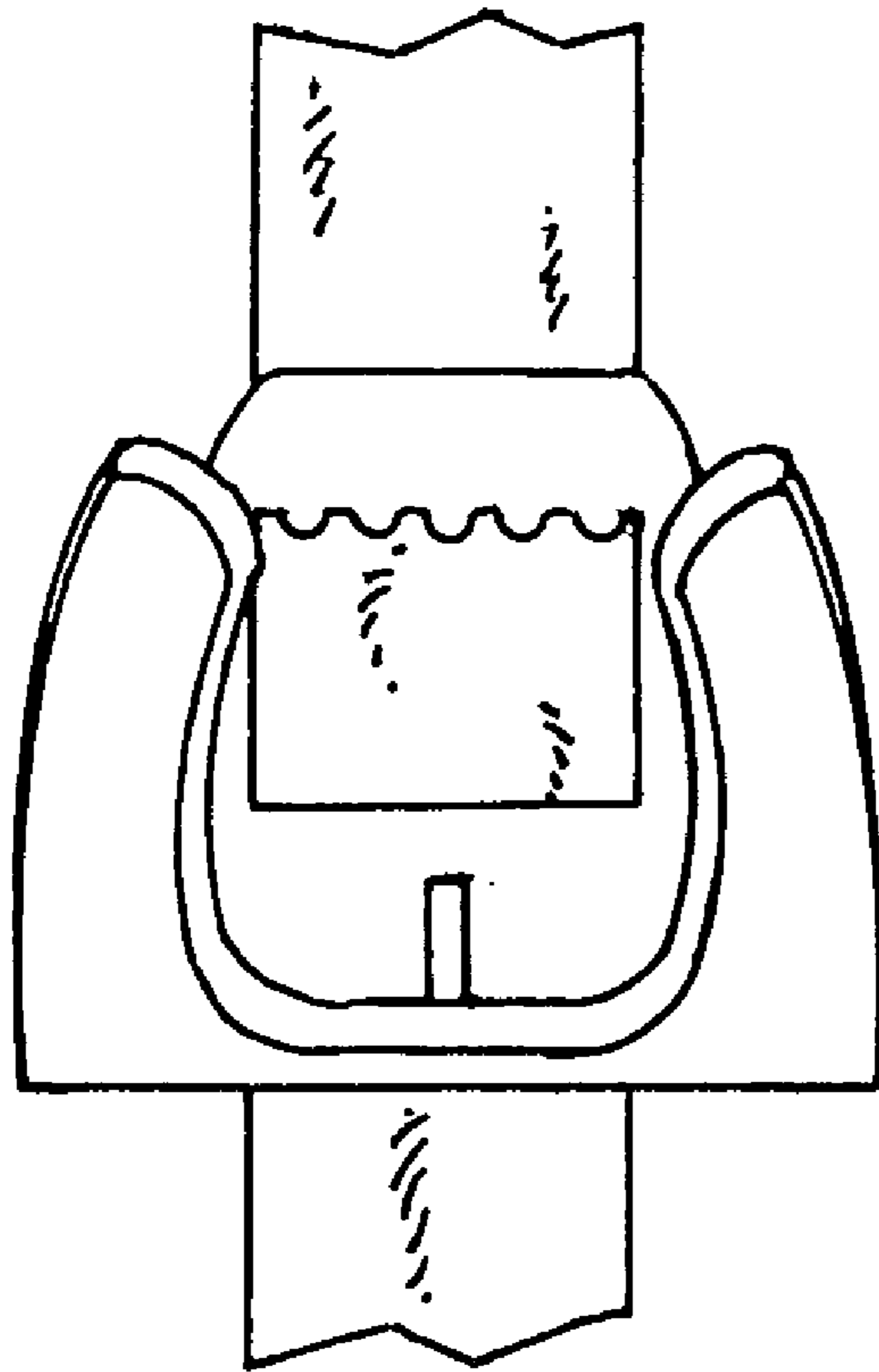

FIG. 5

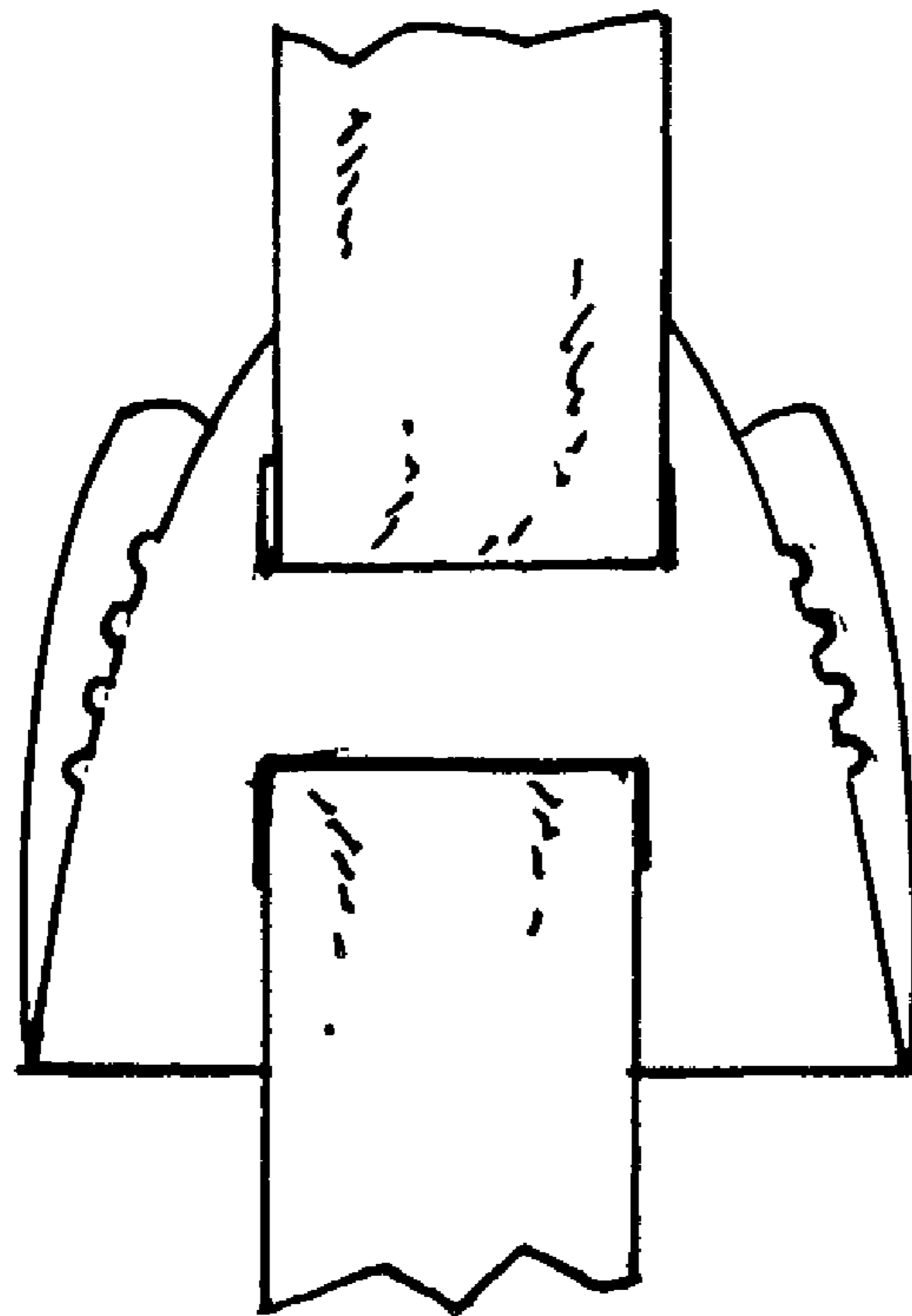

FIG. 6

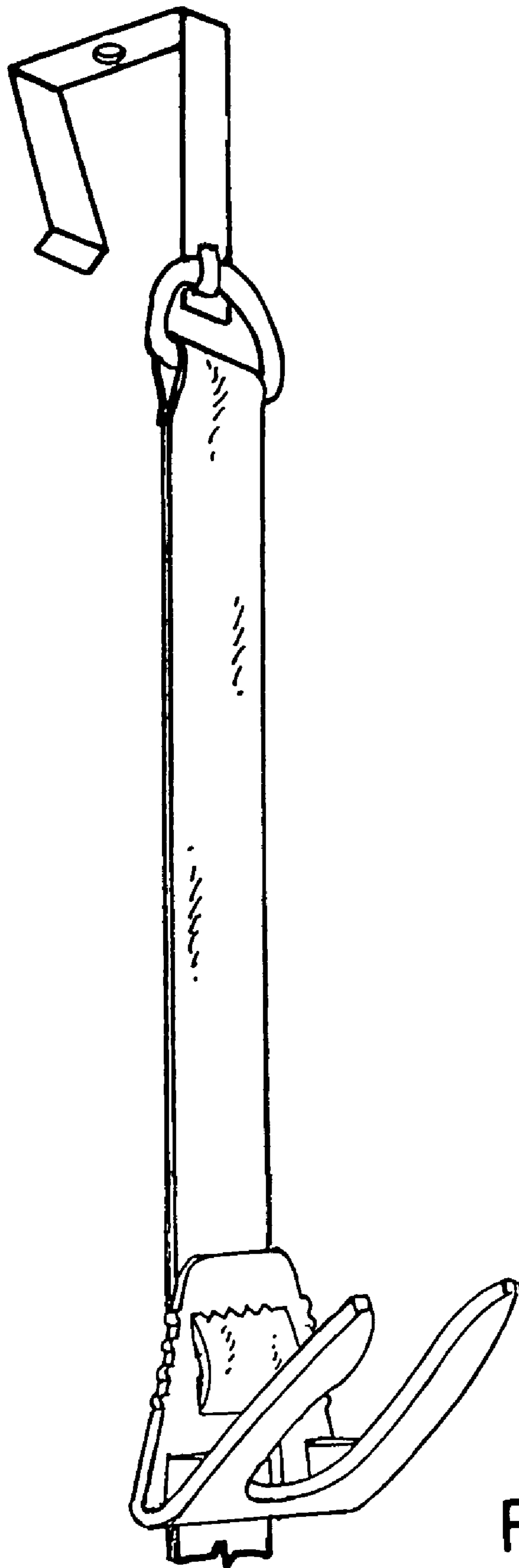

FIG. 7A

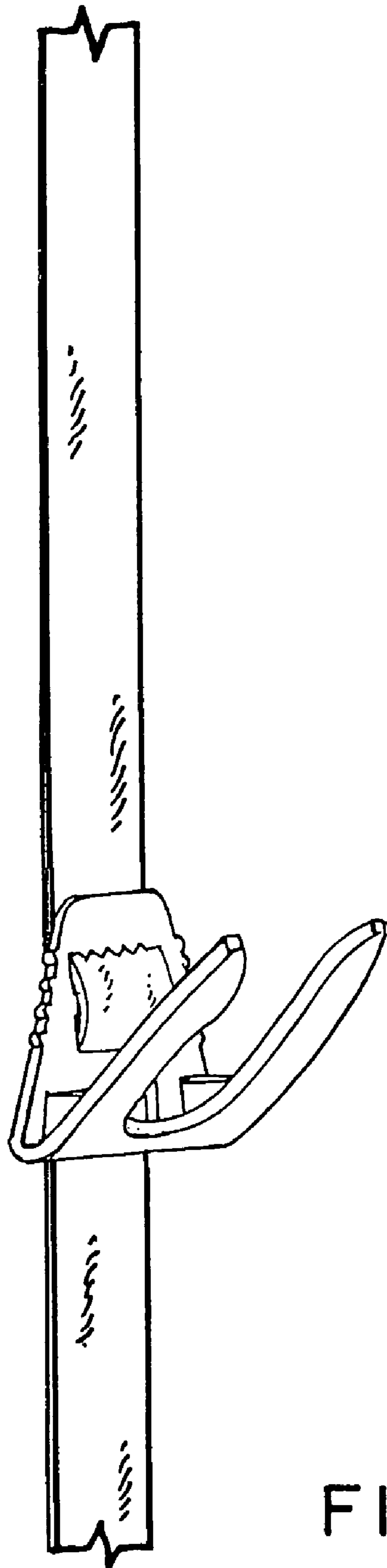

FIG. 7B

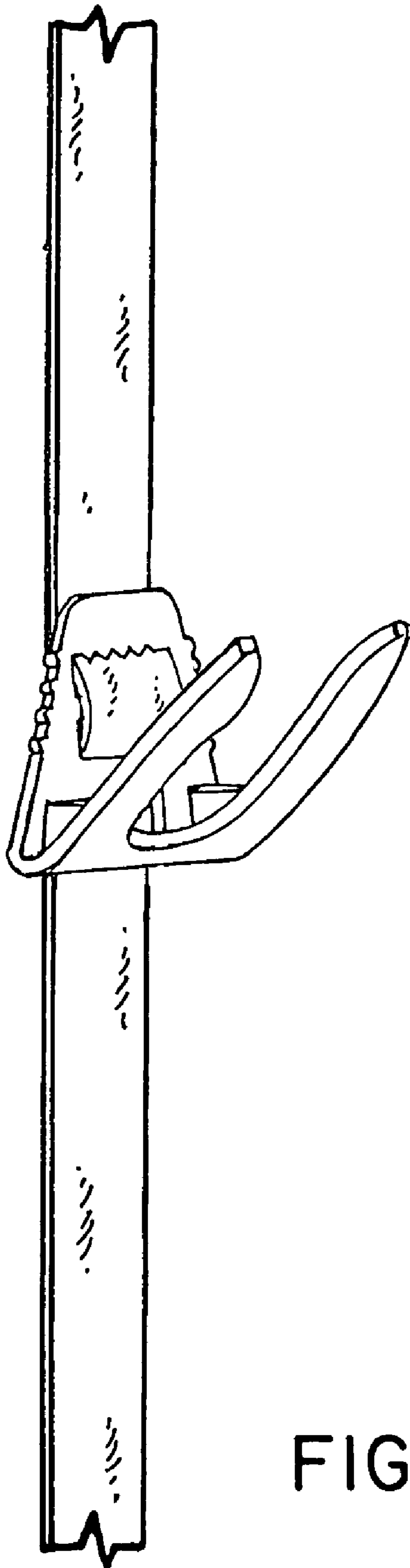

FIG. 7C

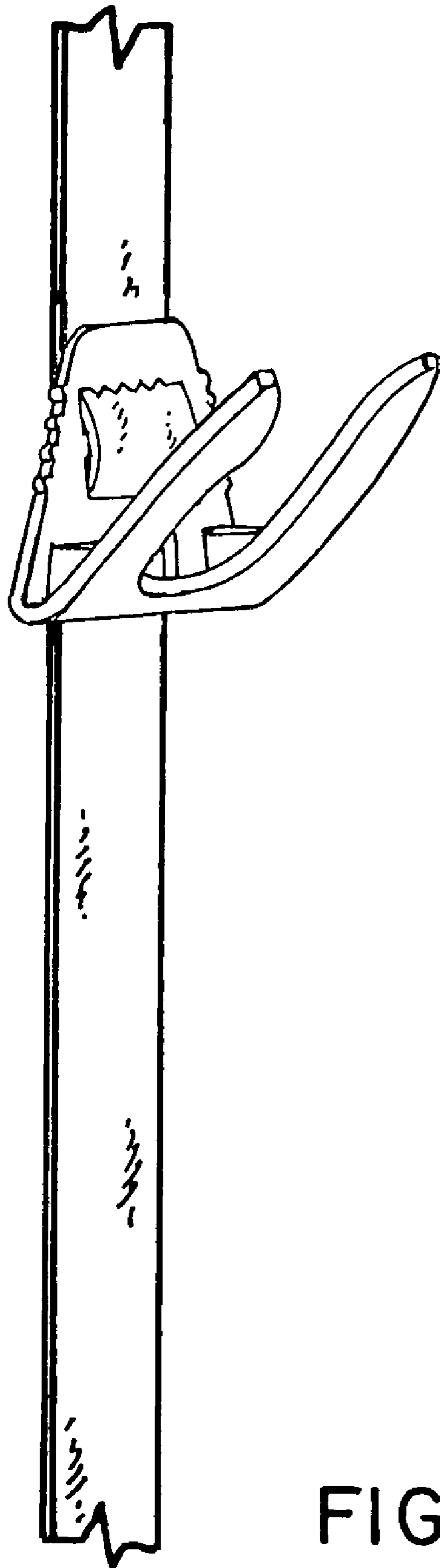

FIG. 7 D

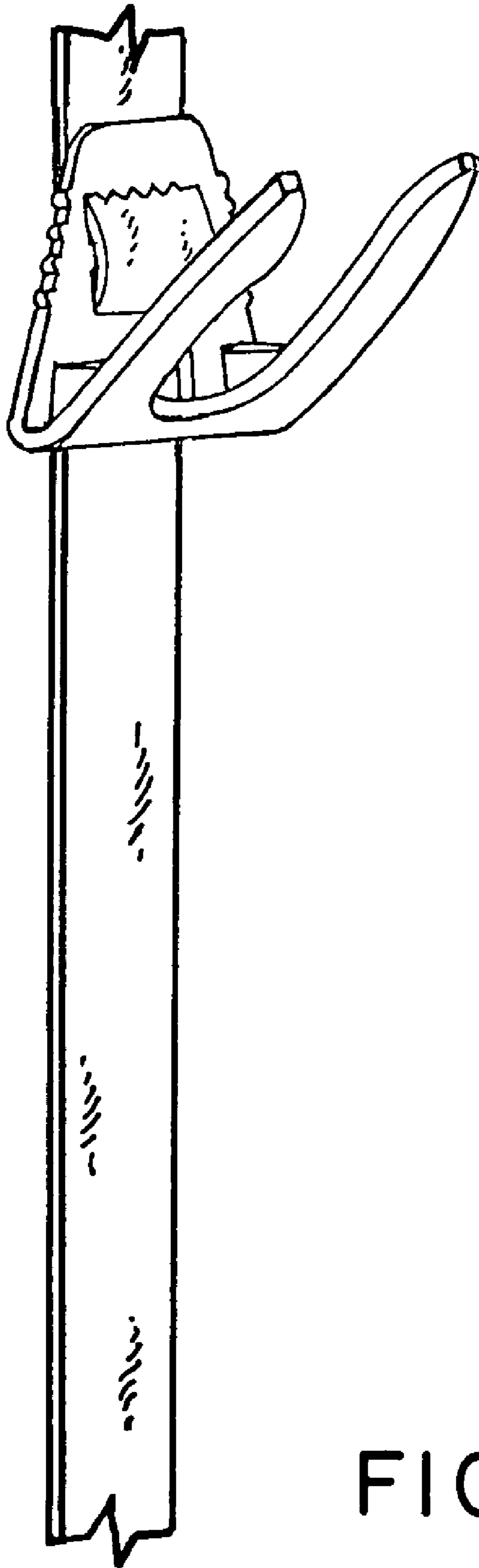

FIG. 7E

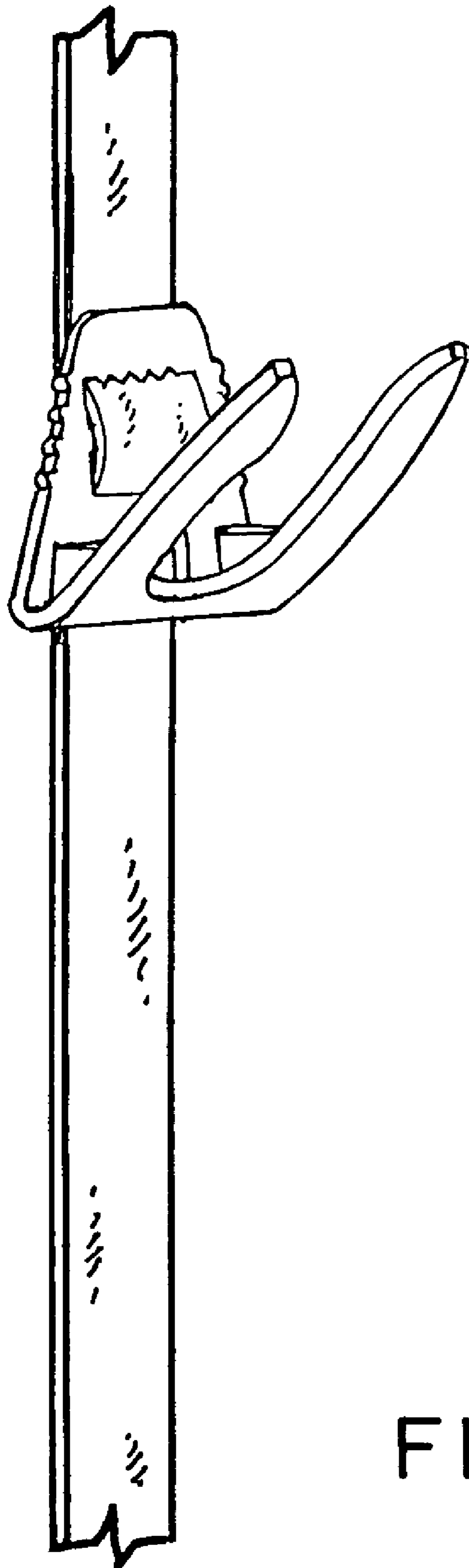

FIG. 7F

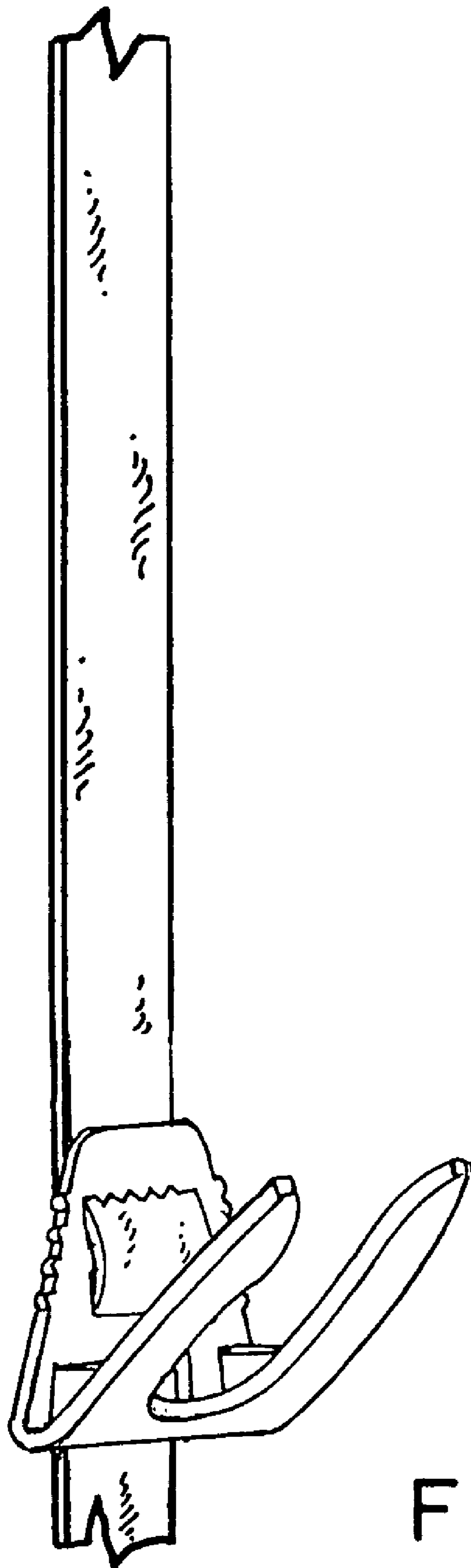

FIG. 7 G

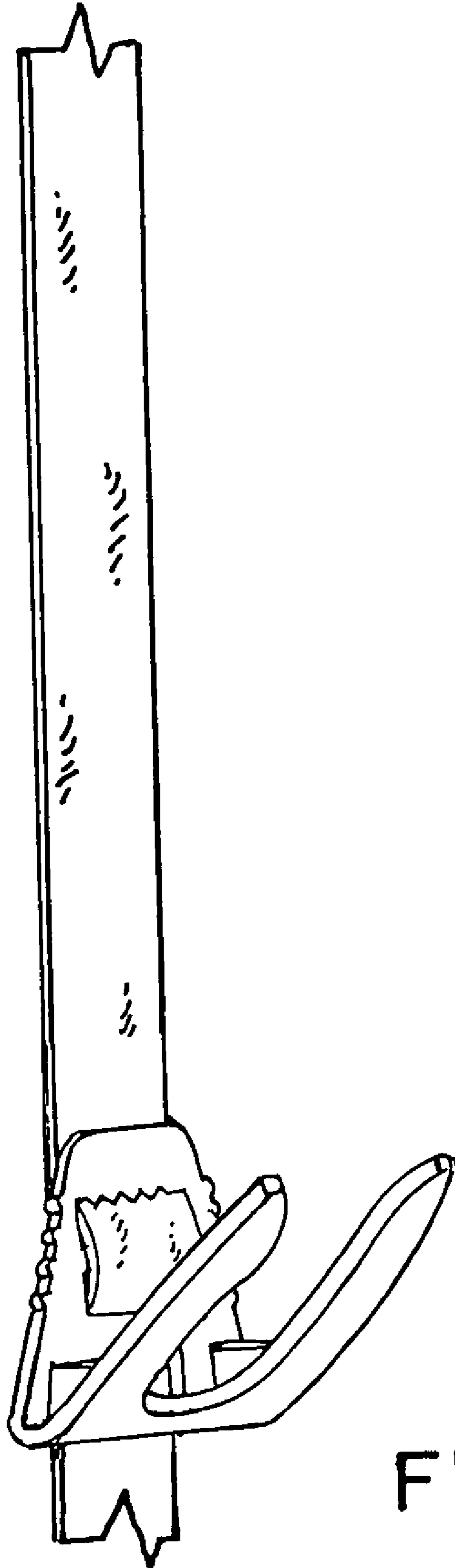

FIG. 7H

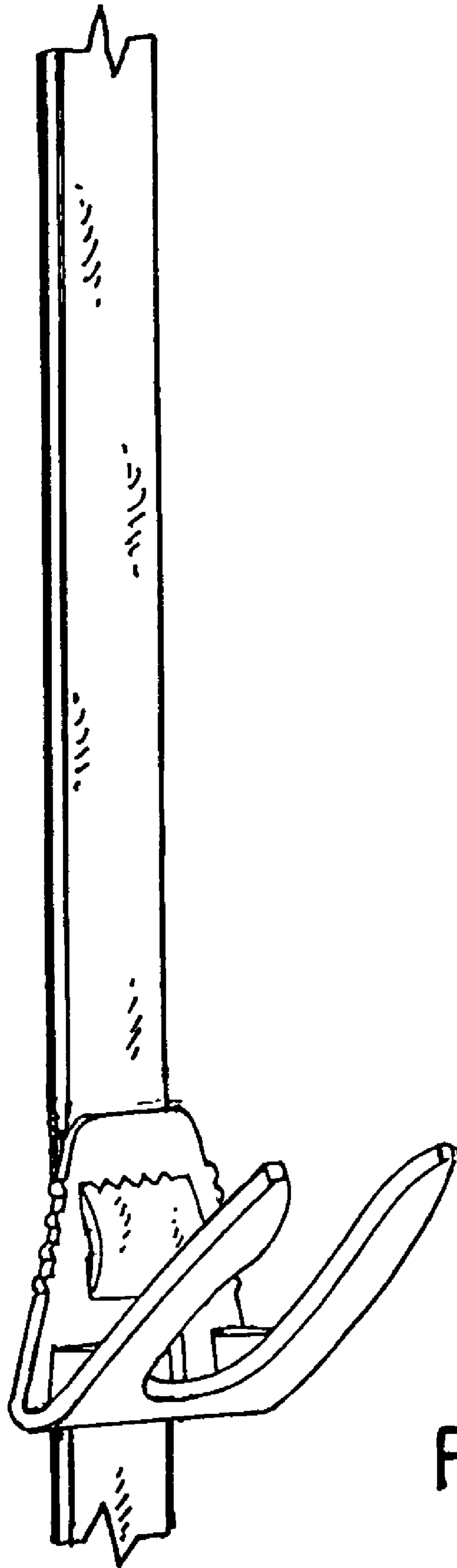

FIG. 7I

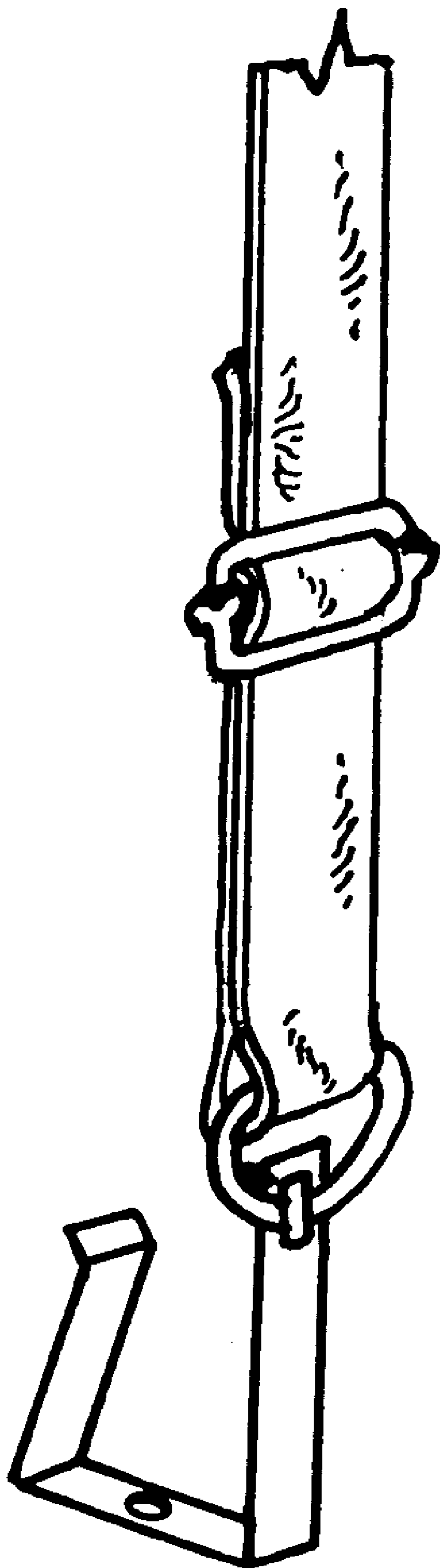

FIG. 7J

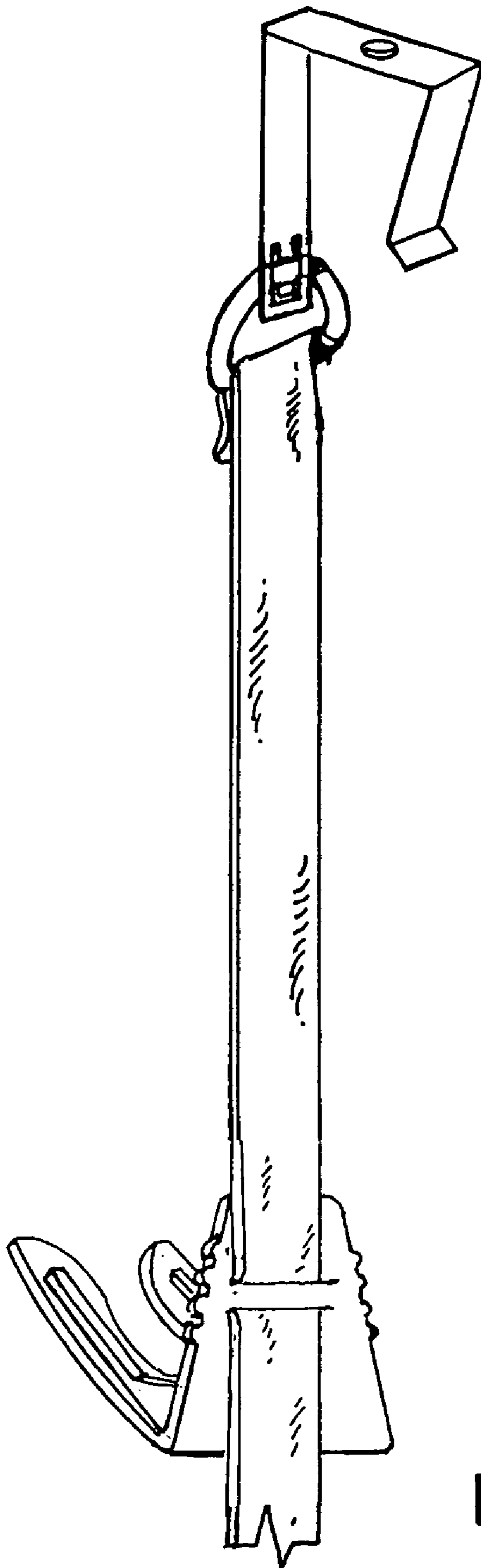

FIG. 8A

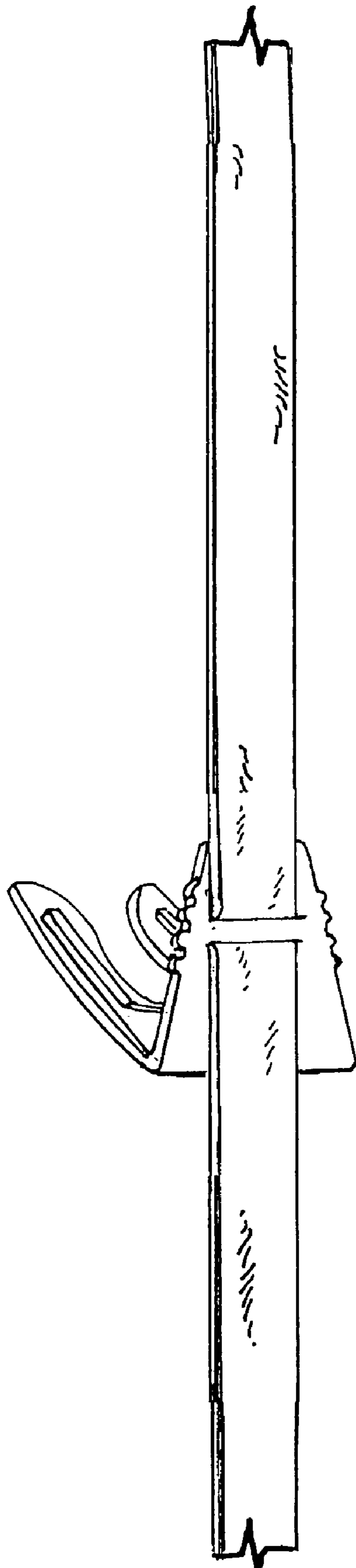

FIG. 8 B

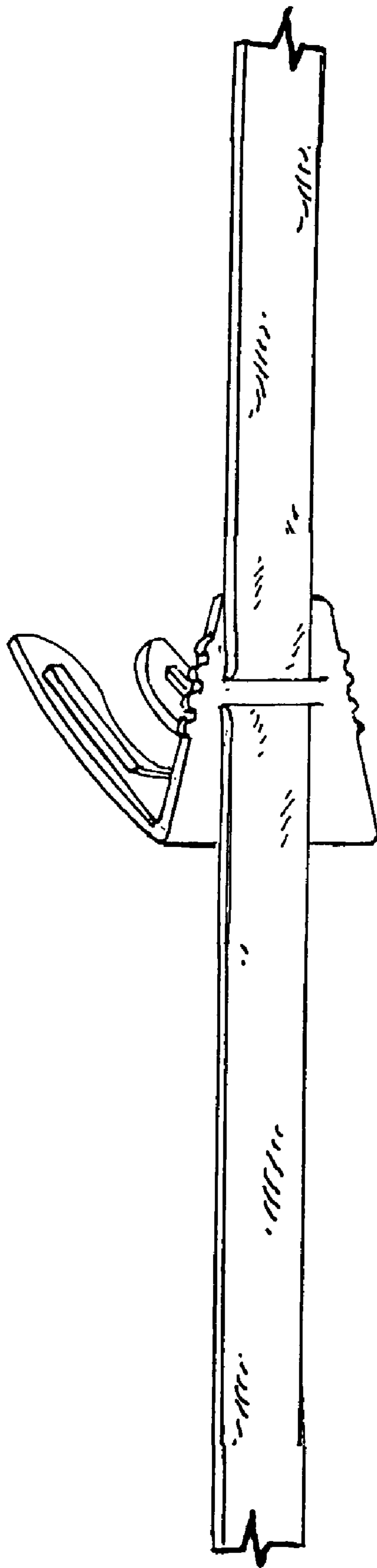

FIG. 8C

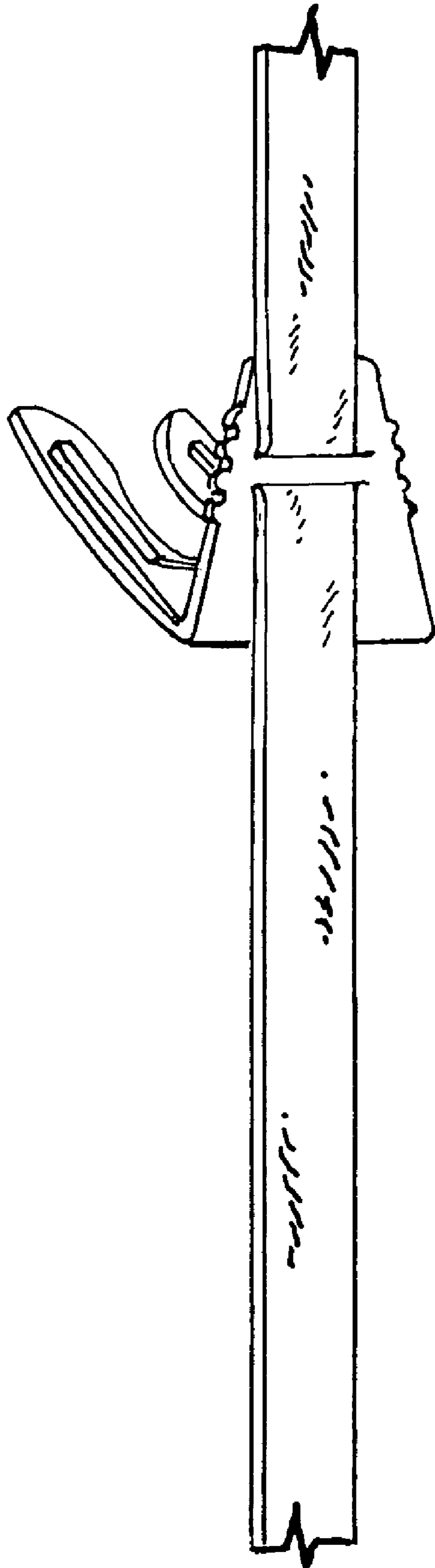

FIG. 8D

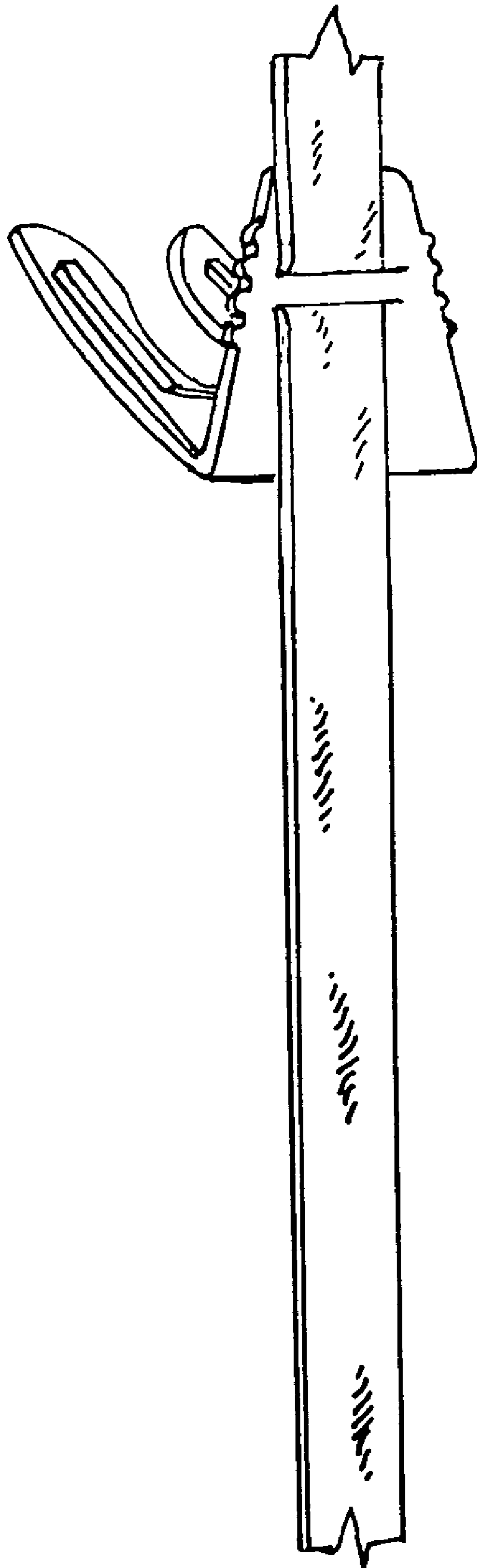

FIG. 8E

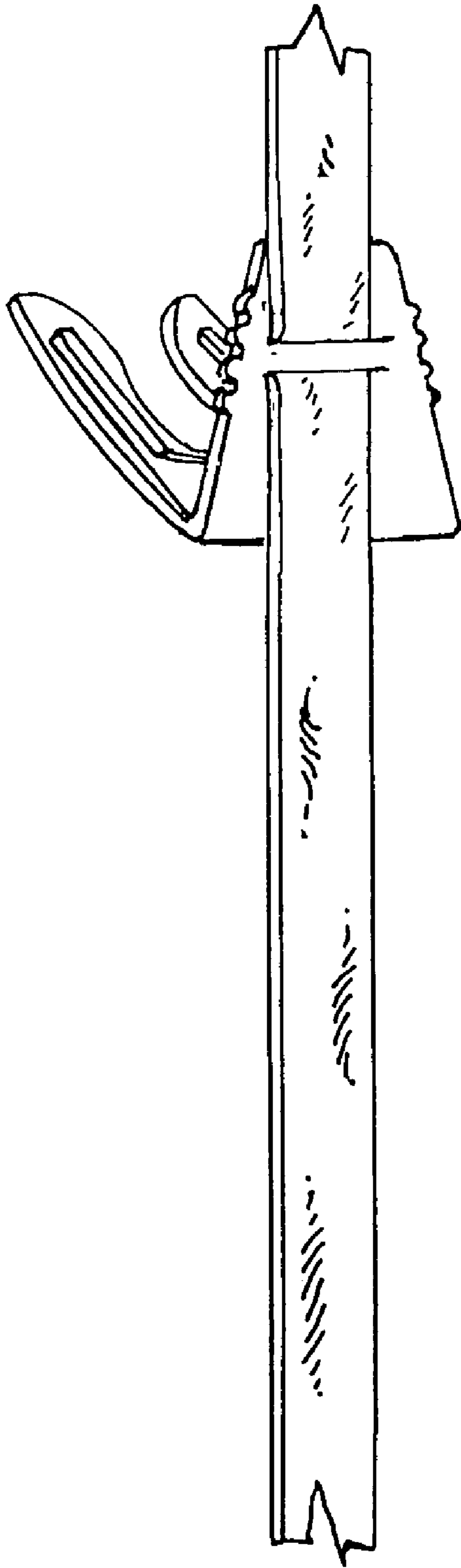

FIG. 8F

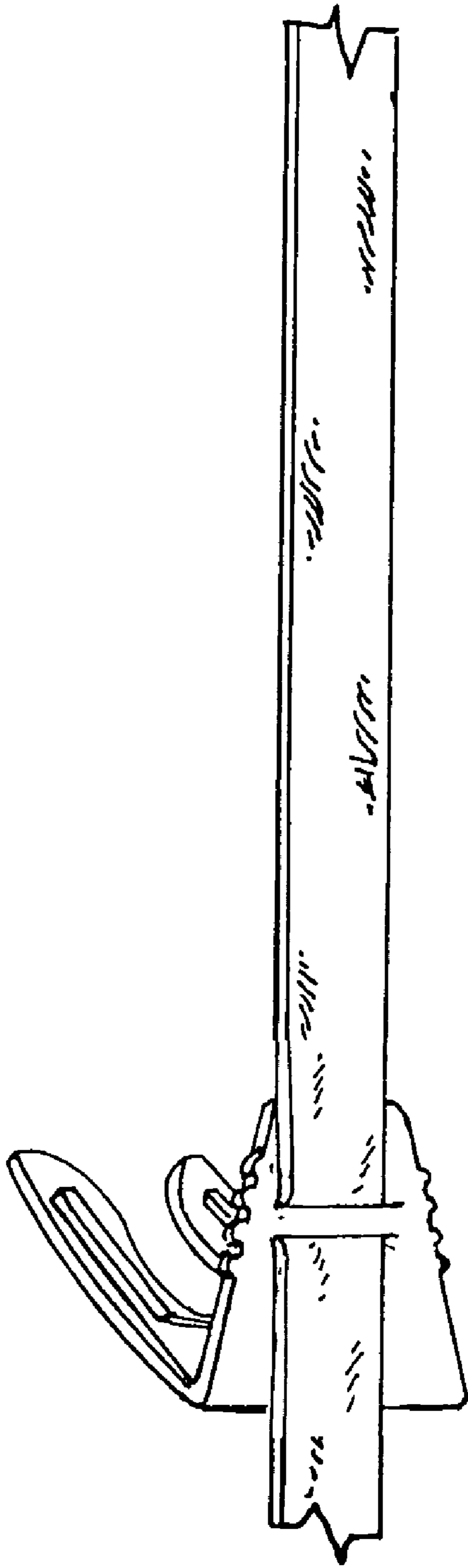

FIG. 8 G

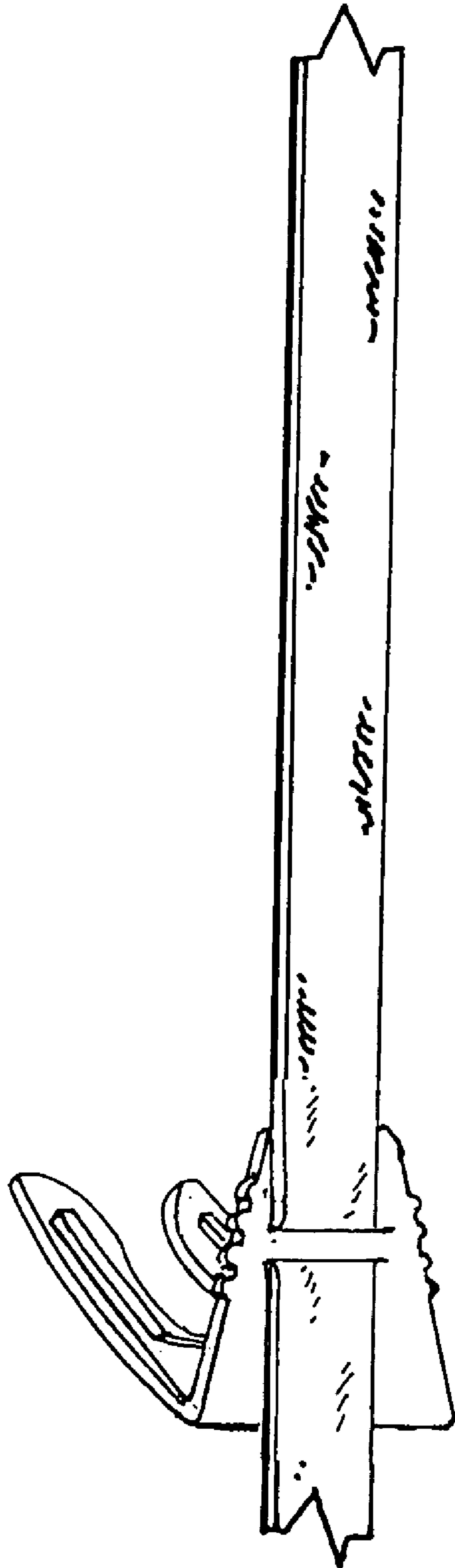

FIG. 8H

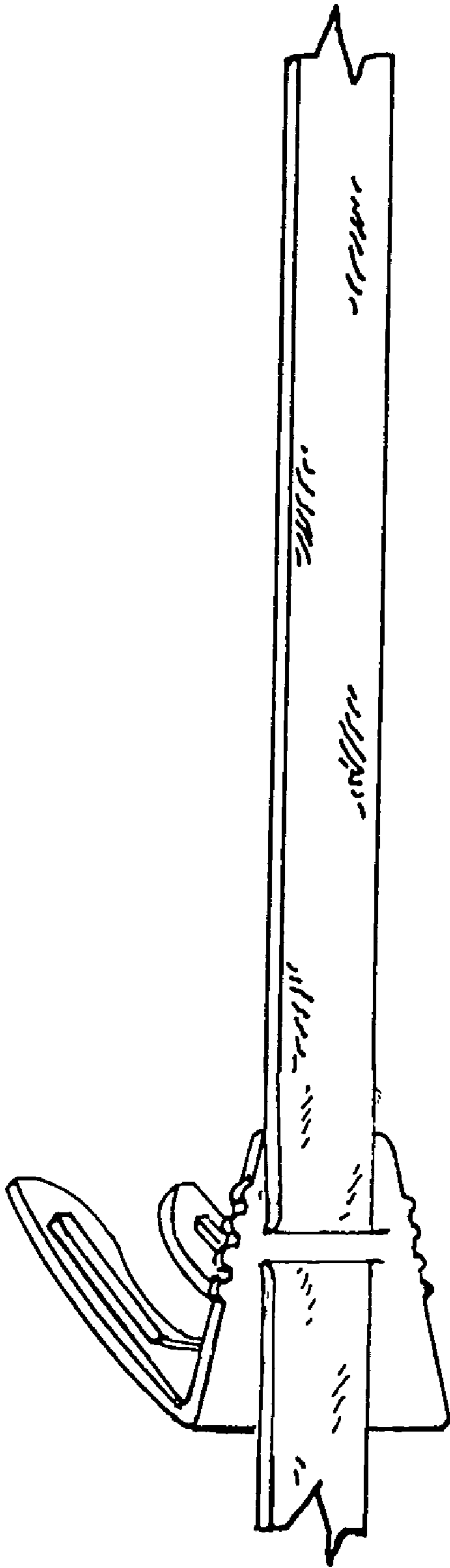

FIG. 81

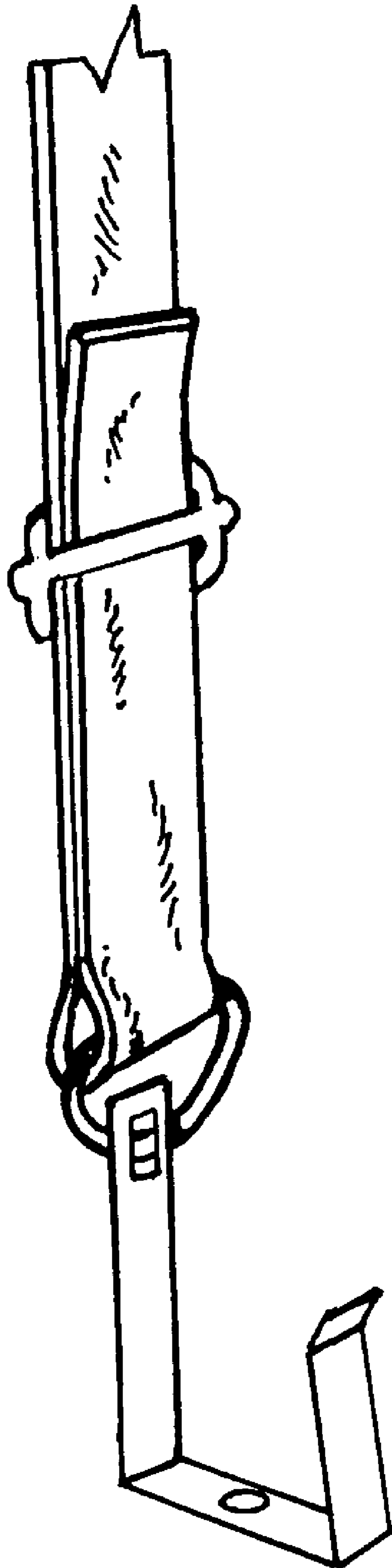

FIG. 8 J