



US00D647238S

(12) **United States Design Patent**
Su

(10) **Patent No.:** **US D647,238 S**

(45) **Date of Patent:** **** Oct. 18, 2011**

(54) **LUMINAIRE HEAD FOR ROAD LAMP**

(75) **Inventor:** **Chun-nan Su**, Tainan (TW)

(73) **Assignee:** **T.Y.C. Brother Industrial Co., Ltd.**,
Tainan (TW)

(**) **Term:** **14 Years**

(21) **Appl. No.:** **29/385,854**

(22) **Filed:** **Feb. 21, 2011**

(51) **LOC (9) Cl.** **26-05**

(52) **U.S. Cl.** **D26/71**

(58) **Field of Classification Search** D26/67-71,
D26/85, 92; 362/145, 183, 231, 240, 249.02,
362/249.03, 249.04, 249.06, 249.16, 373,
362/311.02, 697, 547, 431, 432
See application file for complete search history.

(56) **References Cited**

U.S. PATENT DOCUMENTS

| | | | | | | |
|-----------|---|---|---------|------------------|-------|---------|
| 3,050,620 | A | * | 8/1962 | Schlosser et al. | | 362/431 |
| D194,991 | S | * | 4/1963 | Hisky | | D26/71 |
| D199,327 | S | * | 10/1964 | Guth, Jr. | | D26/72 |
| D199,366 | S | * | 10/1964 | Izzi | | D26/71 |
| D201,909 | S | * | 8/1965 | Harling | | D26/71 |

| | | | | | | |
|----------|---|---|---------|----------|-------|--------|
| D203,217 | S | * | 12/1965 | Greenhaw | | D26/71 |
| D346,237 | S | * | 4/1994 | Schreder | | D26/71 |
| D599,940 | S | * | 9/2009 | Zheng | | D26/71 |
| D622,889 | S | * | 8/2010 | Zheng | | D26/71 |
| D636,518 | S | * | 4/2011 | Nevins | | D26/71 |

* cited by examiner

Primary Examiner — Clare E Heflin

(74) *Attorney, Agent, or Firm* — Cheng-Ju Chiang

(57) **CLAIM**

The ornamental design for a luminaire head for road lamp, as shown and described.

DESCRIPTION

FIG. 1 is a perspective view of a luminaire head for a road lamp showing my new design; FIG. 2 is a front view thereof; FIG. 3 is a rear view thereof; FIG. 4 is a left side view thereof; FIG. 5 is a right side view thereof; FIG. 6 is a top view thereof; FIG. 7 is a bottom view thereof; and, FIG. 8 is another perspective view thereof. The broken lines shown on the drawings depict environment only and form no part of the claimed design.

1 Claim, 5 Drawing Sheets

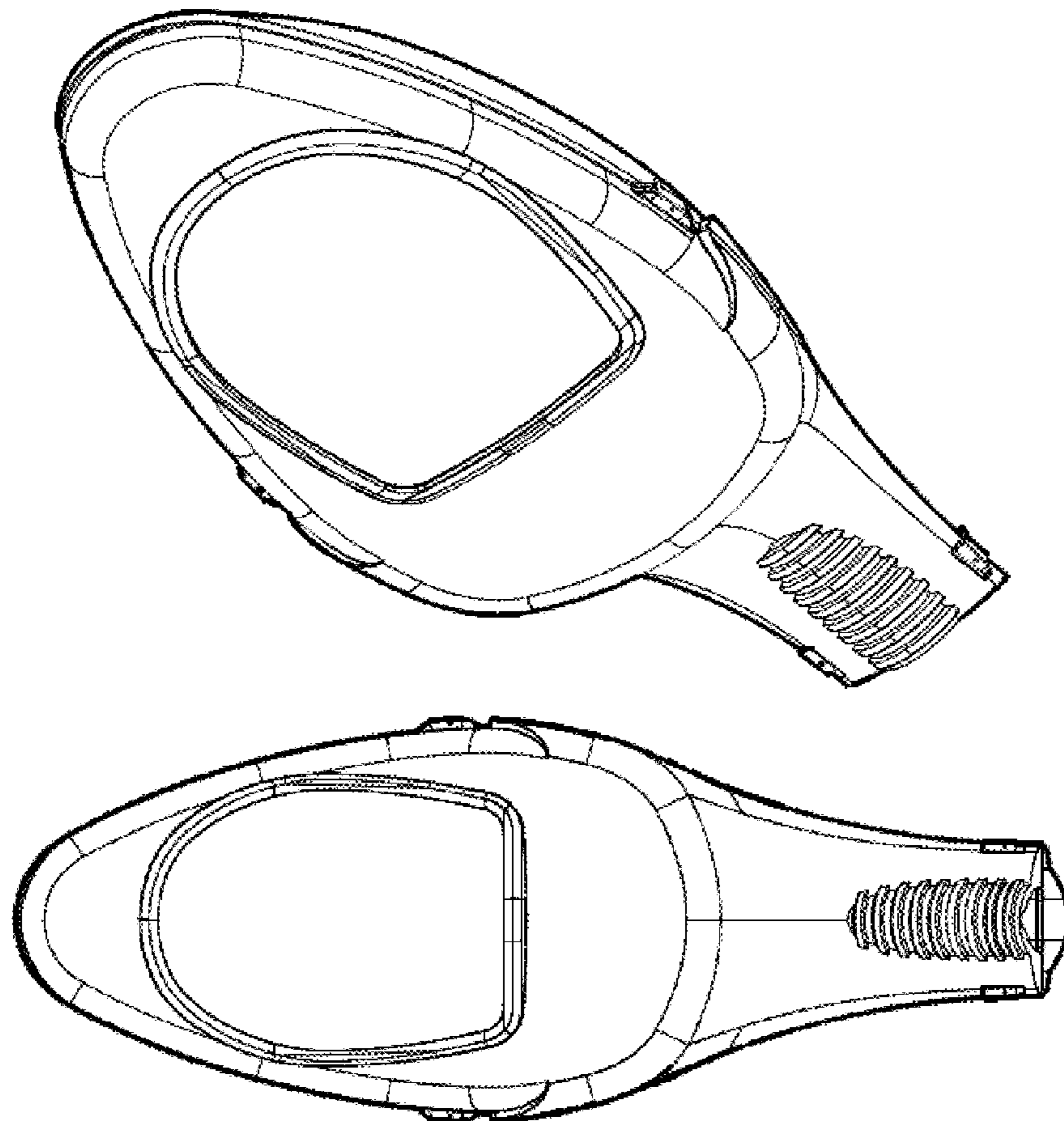

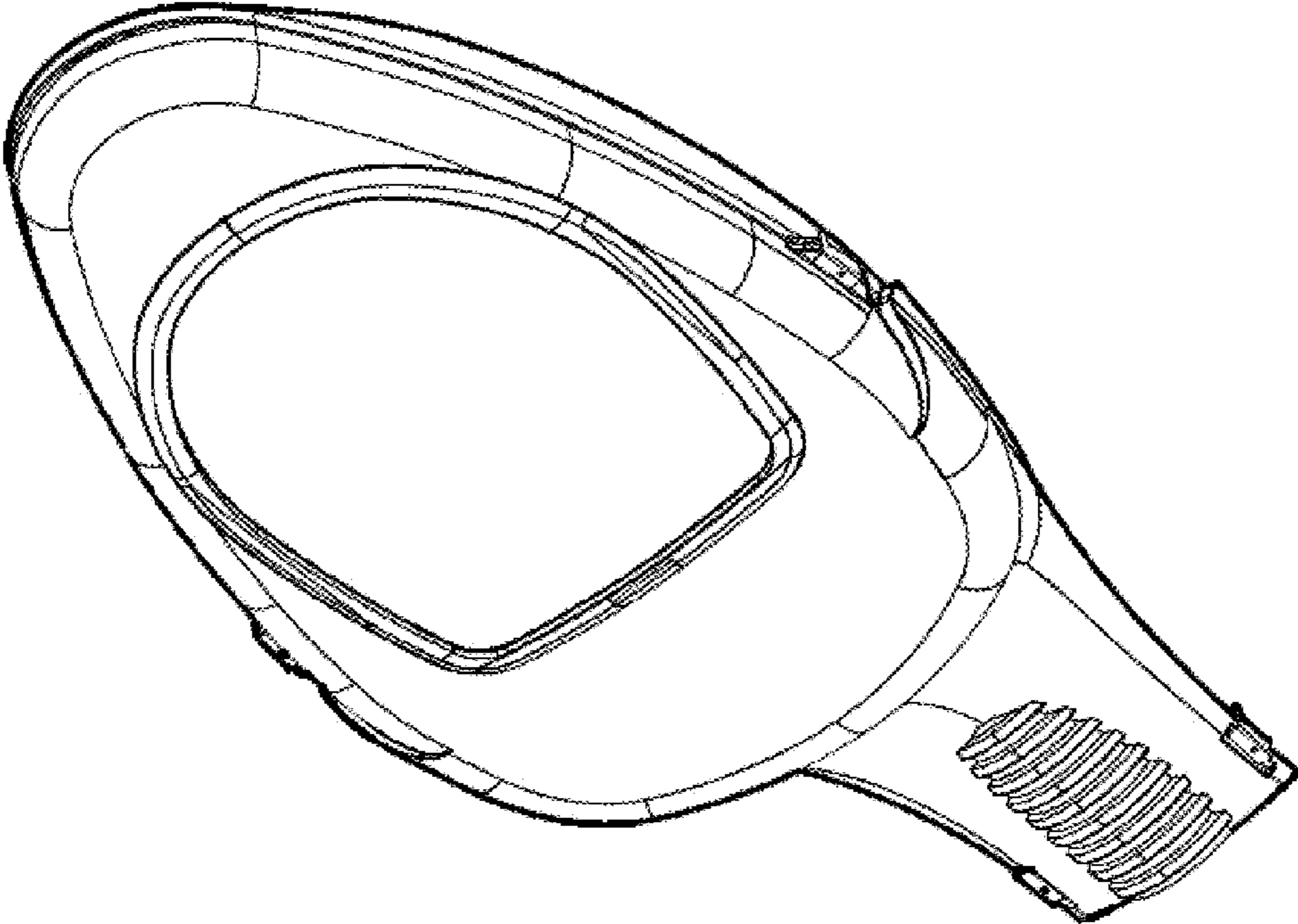

FIG. 1

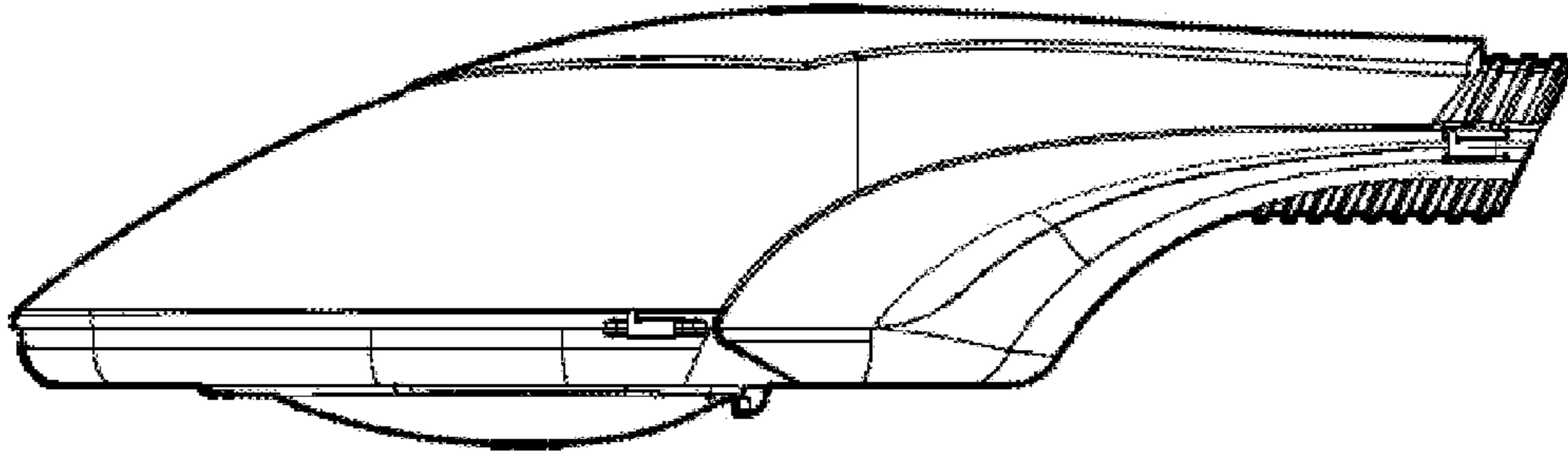

FIG. 2

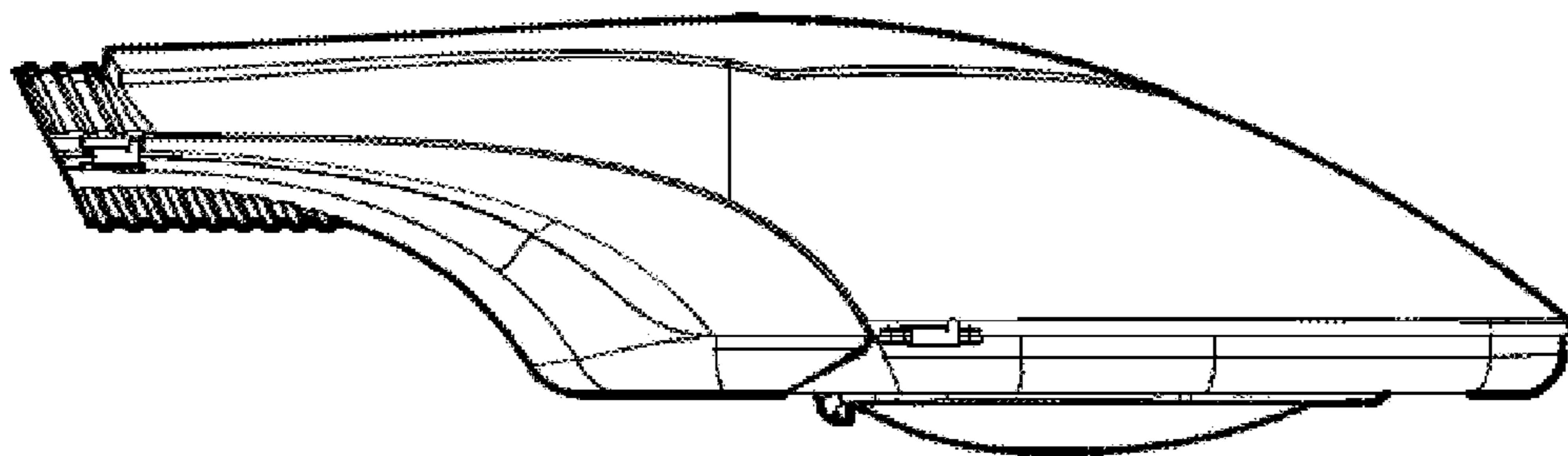

FIG. 3

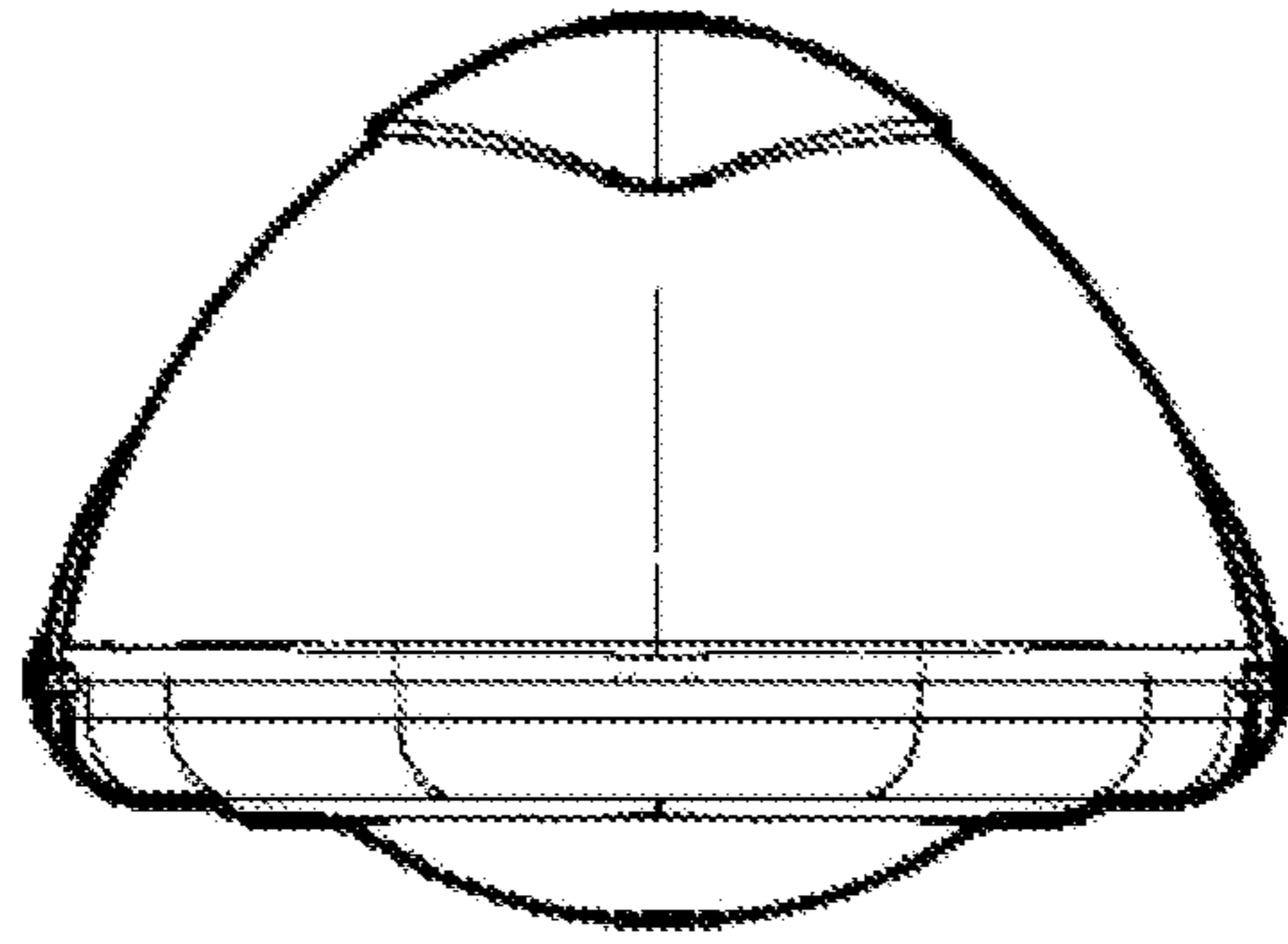

FIG. 4

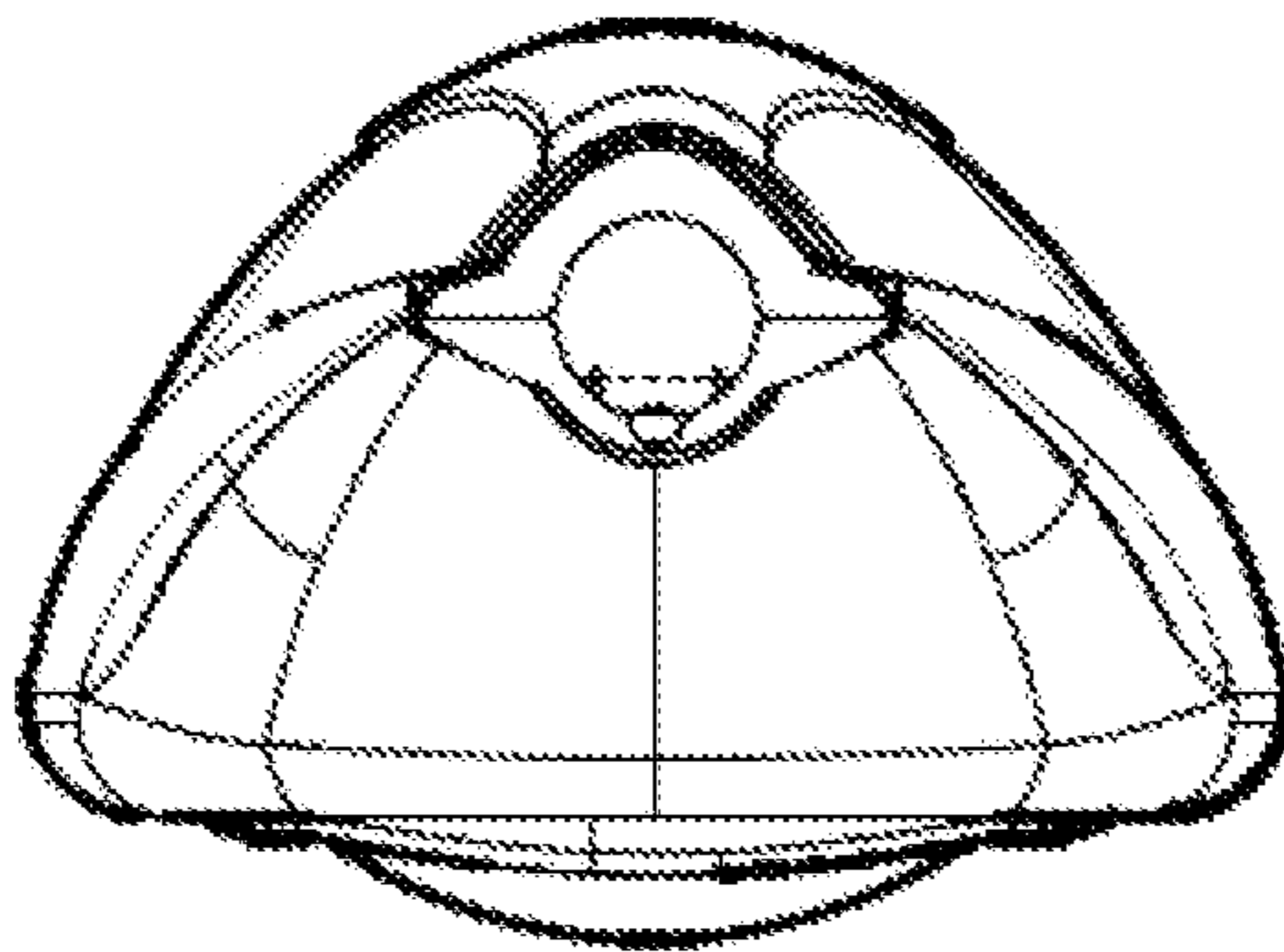

FIG. 5

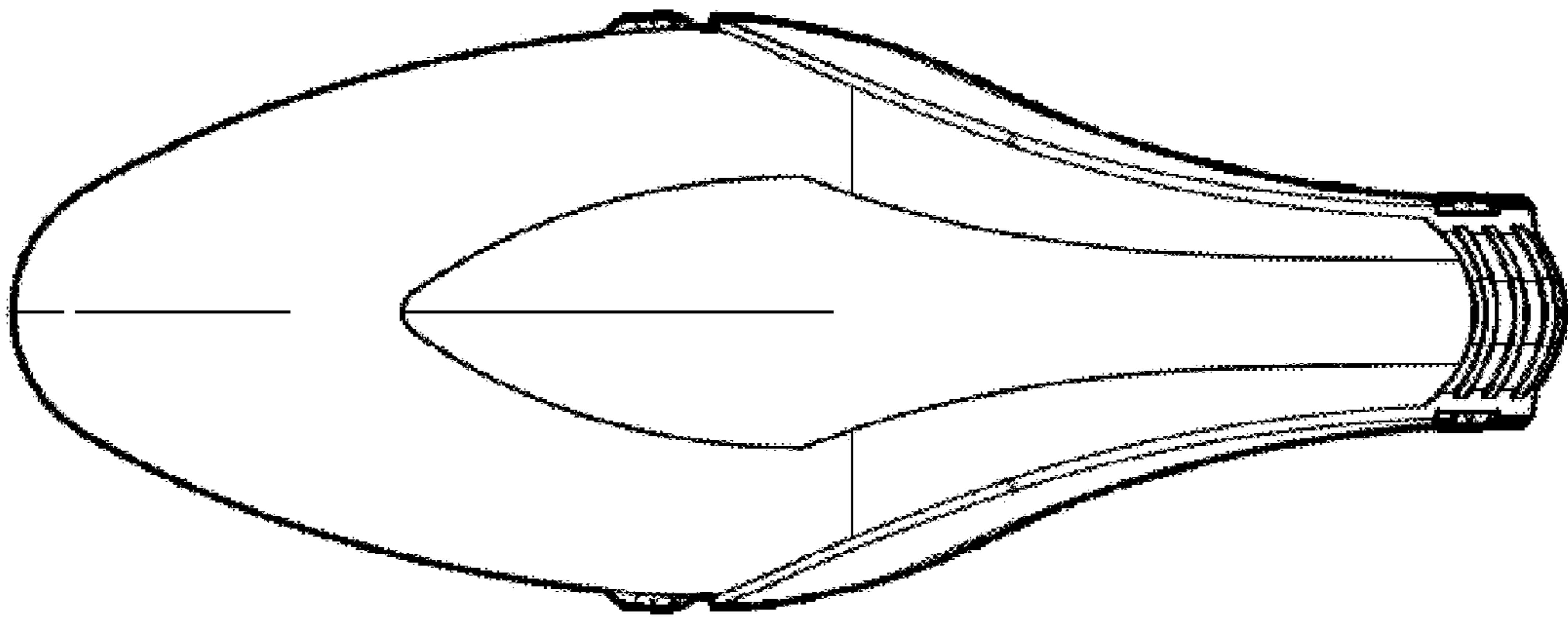

FIG. 6

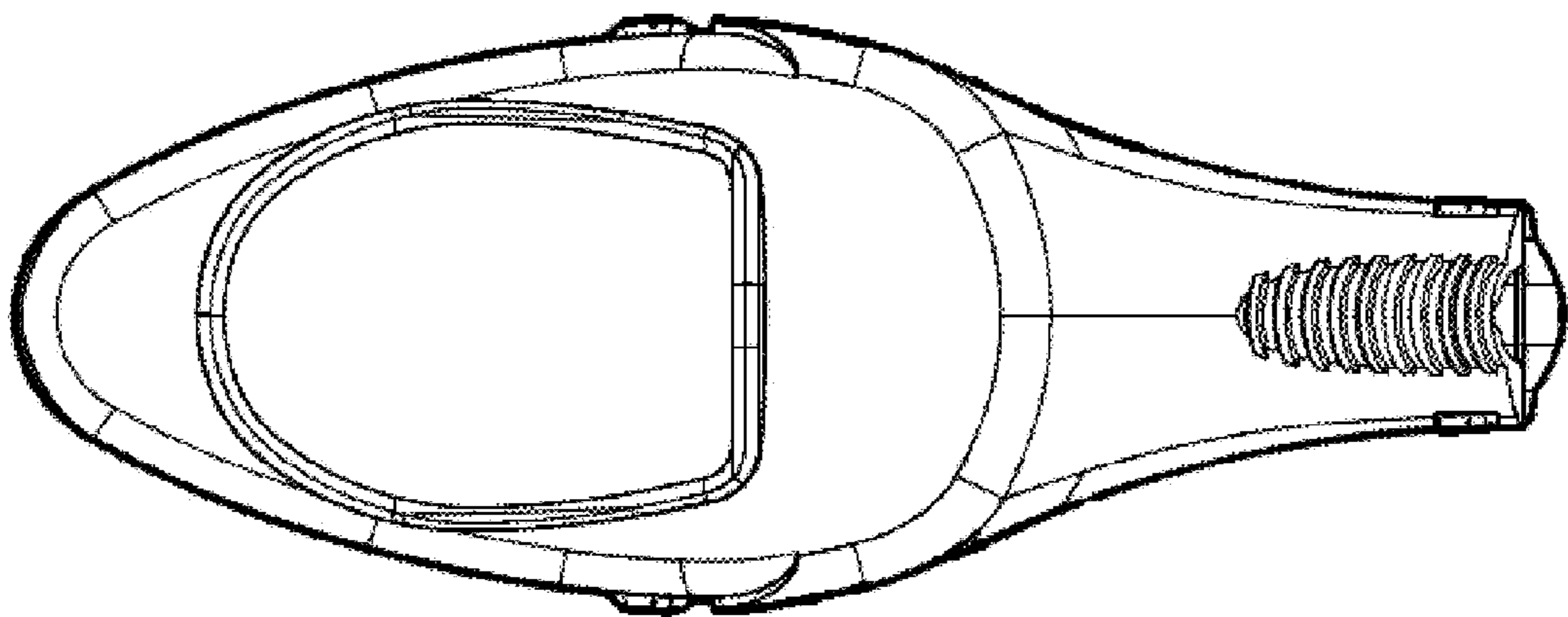

FIG. 7

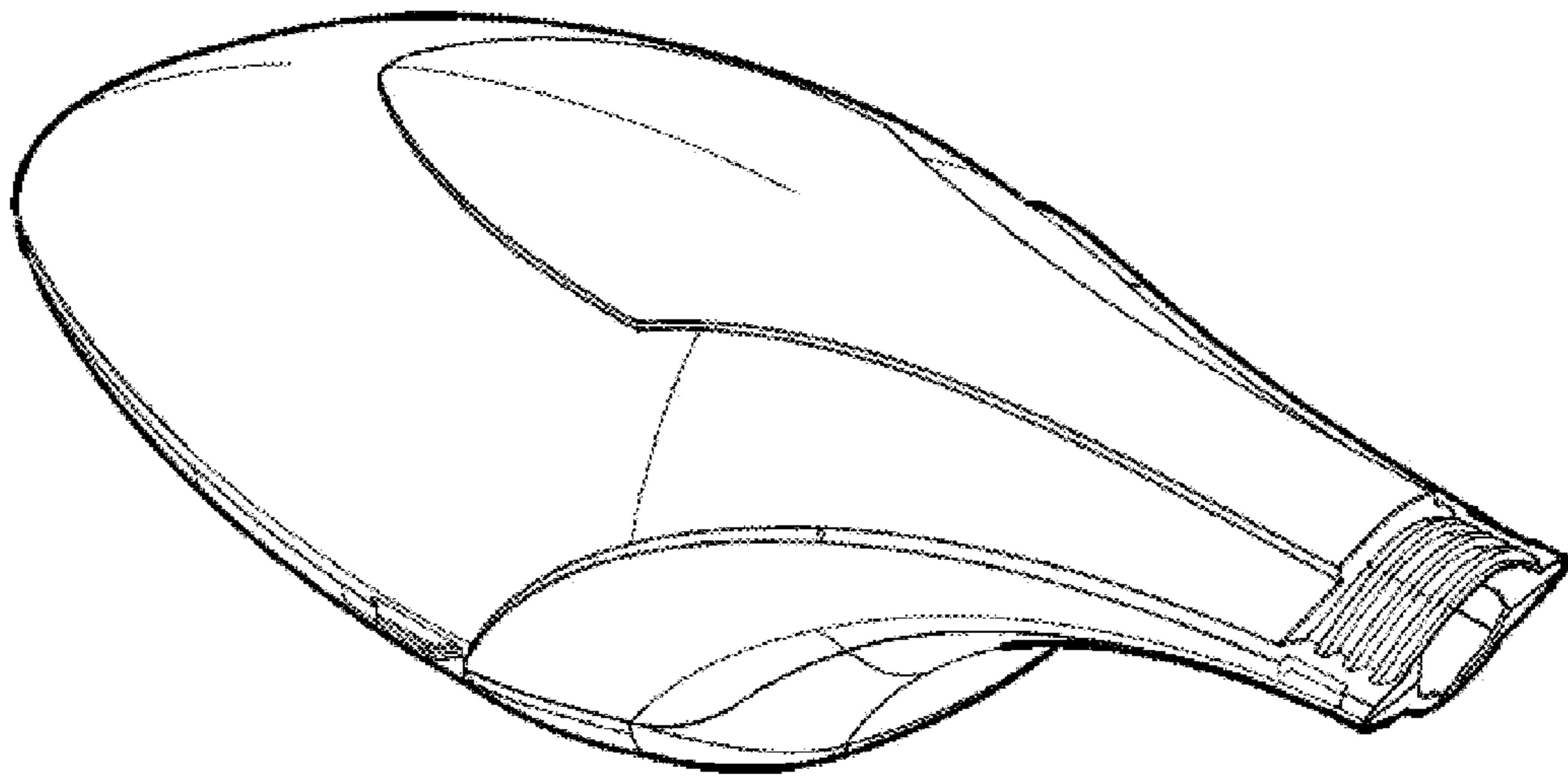

FIG. 8