



US00D647199S

(12) **United States Design Patent**  
**Kroiss**

(10) **Patent No.:** **US D647,199 S**  
(45) **Date of Patent:** **\*\* Oct. 18, 2011**

(54) **VOMIT CONTAINER**

(76) Inventor: **Cindy L. Kroiss**, Snoqualmie, WA (US)

(\*\*) Term: **14 Years**

(21) Appl. No.: **29/338,531**

(22) Filed: **Jun. 12, 2009**

D404,241	S	*	1/1999	Bagley	.....	D7/513
6,126,632	A	*	10/2000	Verbovszky et al.	.....	604/78
D452,416	S	*	12/2001	Hagerty	.....	D7/534
D454,642	S	*	3/2002	Hakim	.....	D24/197
D460,322	S	*	7/2002	Orr et al.	.....	D7/510
D495,558	S	*	9/2004	Tollman	.....	D7/510
D552,932	S	*	10/2007	Carlson	.....	D7/536
D574,671	S	*	8/2008	Chiang et al.	.....	D7/629
D630,060	S	*	1/2011	DelVecchio	.....	D7/534
2007/0045323	A1	*	3/2007	Kroiss	.....	220/495.06

**Related U.S. Application Data**

(63) Continuation of application No. 11/466,752, filed on Aug. 23, 2006, now abandoned.

(51) **LOC (9) Cl.** ..... **24-02**

(52) **U.S. Cl.** ..... **D24/123**

(58) **Field of Classification Search** ..... D7/317,  
D7/507, 510, 511, 513, 534, 536, 543, 548;  
D24/121, 123, 197; 215/11.1, 398; 220/495.06,  
220/603; 604/317, 398

See application file for complete search history.

(56) **References Cited**

**U.S. PATENT DOCUMENTS**

D139,711	S	*	12/1944	Pannhausen et al.	.....	D24/123
D155,304	S	*	9/1949	McKay	.....	D7/534
D162,610	S	*	3/1951	Aitken	.....	D24/123
D166,832	S	*	5/1952	Thompson et al.	.....	D7/534
2,792,696	A	*	5/1957	Stayart	.....	215/11.1
D194,622	S	*	2/1963	Swett	.....	D7/317
D233,972	S	*	12/1974	Juhlin	.....	D7/511
D244,246	S	*	5/1977	Daenen	.....	D7/540
D258,037	S	*	1/1981	Conti	.....	D7/598
D279,752	S	*	7/1985	Jagger	.....	D7/510
D283,002	S	*	3/1986	Daenen	.....	D7/319
D283,193	S	*	4/1986	Daenen	.....	D7/317
4,810,245	A	*	3/1989	Aagesen	.....	604/78
D307,477	S	*	4/1990	Gonzalez et al.	.....	D24/197
D315,213	S	*	3/1991	Ohnuki	.....	D24/197
D343,763	S	*	2/1994	Zimmerman	.....	D7/548
D346,932	S	*	5/1994	Cautereels et al.	.....	D7/507
D352,201	S	*	11/1994	Spence, Jr.	.....	D7/534
D366,988	S	*	2/1996	Nowak	.....	D7/534

**OTHER PUBLICATIONS**

Sick Bear Bowl, as pictured in article, "Apr. 2007 New Toys—Preschool," [on-line]; [posted to the Internet Apr. 2007]; [retrieved from the Internet Feb. 8, 2011]; URL: <http://www.toydirectory.com/monthly/newtoys/apr07/...>. (8 pages).\*

Sick Bear Bowl, as pictured in article, "Sick Bear Contest," [on-line]; [posted to Internet on Apr. 12, 2007]; [retrieved from the Internet on Feb. 8, 2011]; URL: <www.5minutesformom.com/1411/sick-bear-contest/>. (2 pages).\*

(Continued)

*Primary Examiner* — Karen E Eldridge Powers

(74) *Attorney, Agent, or Firm* — ÆON Law; Adam L. K. Philipp

(57) **CLAIM**

The ornamental design for a vomit container, as shown and described.

**DESCRIPTION**

FIG. 1 is a front view of a vomit container showing my new design.

FIG. 2 is a rear view thereof.

FIG. 3 is a left side view thereof.

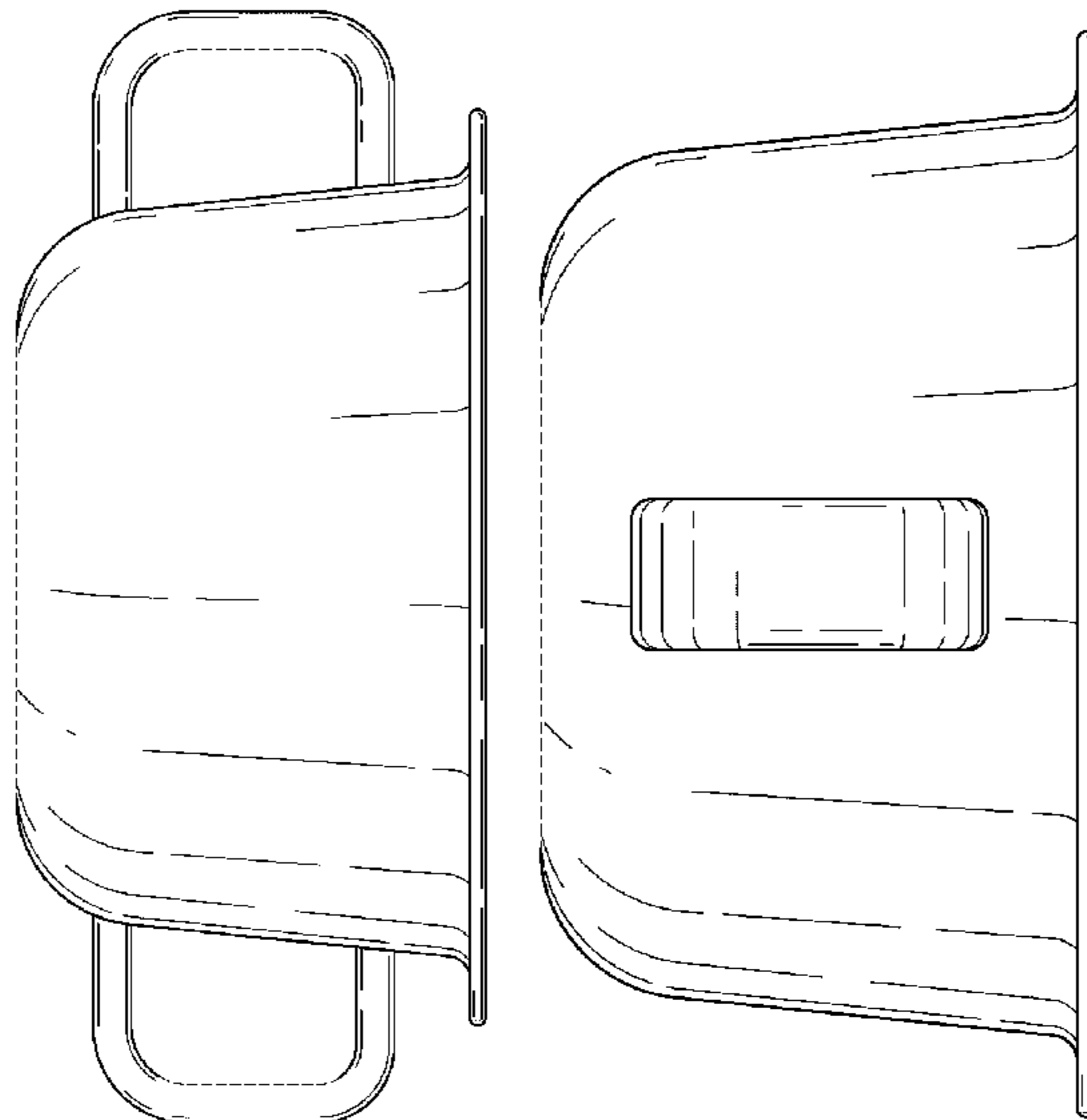
FIG. 4 is a right side view thereof.

FIG. 5 is a bottom view thereof; and,

FIG. 6 is top view thereof.

The details shown in broken lines form no part of the claimed design.

**1 Claim, 6 Drawing Sheets**

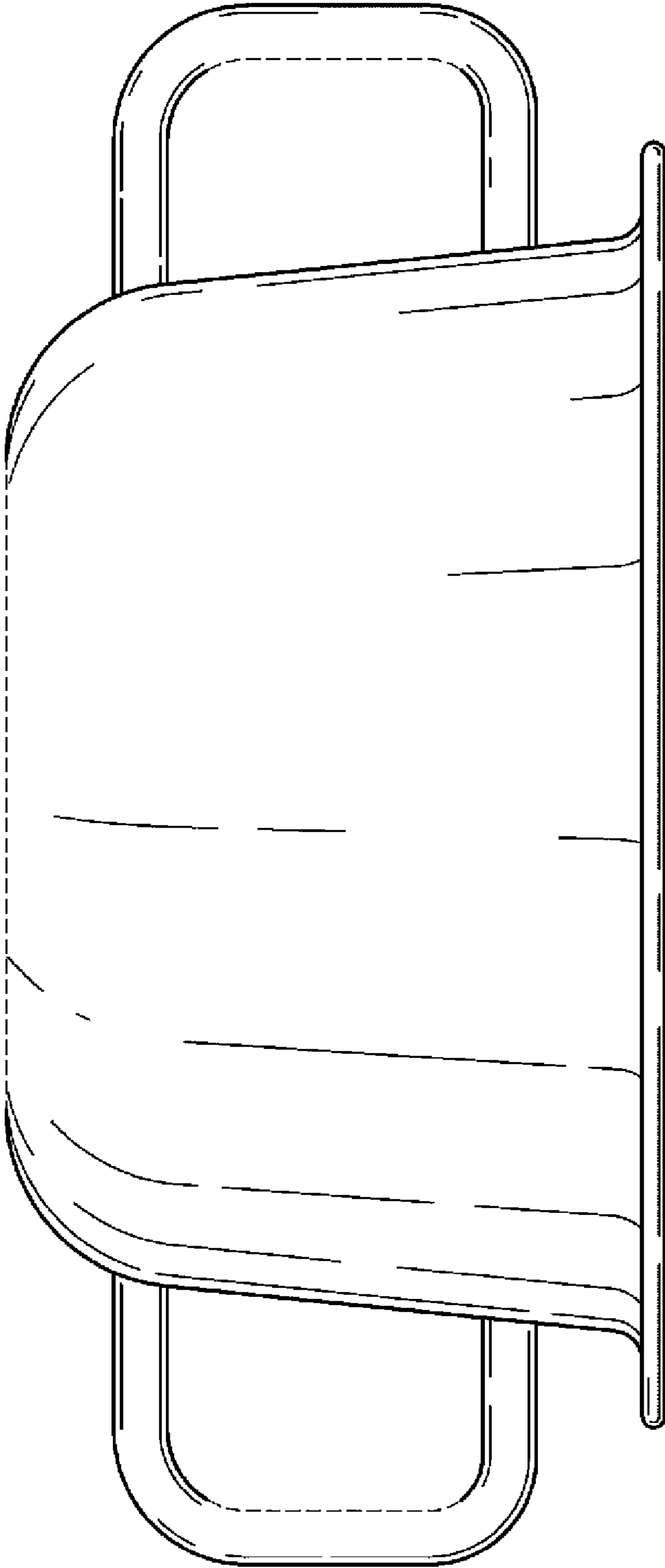


OTHER PUBLICATIONS

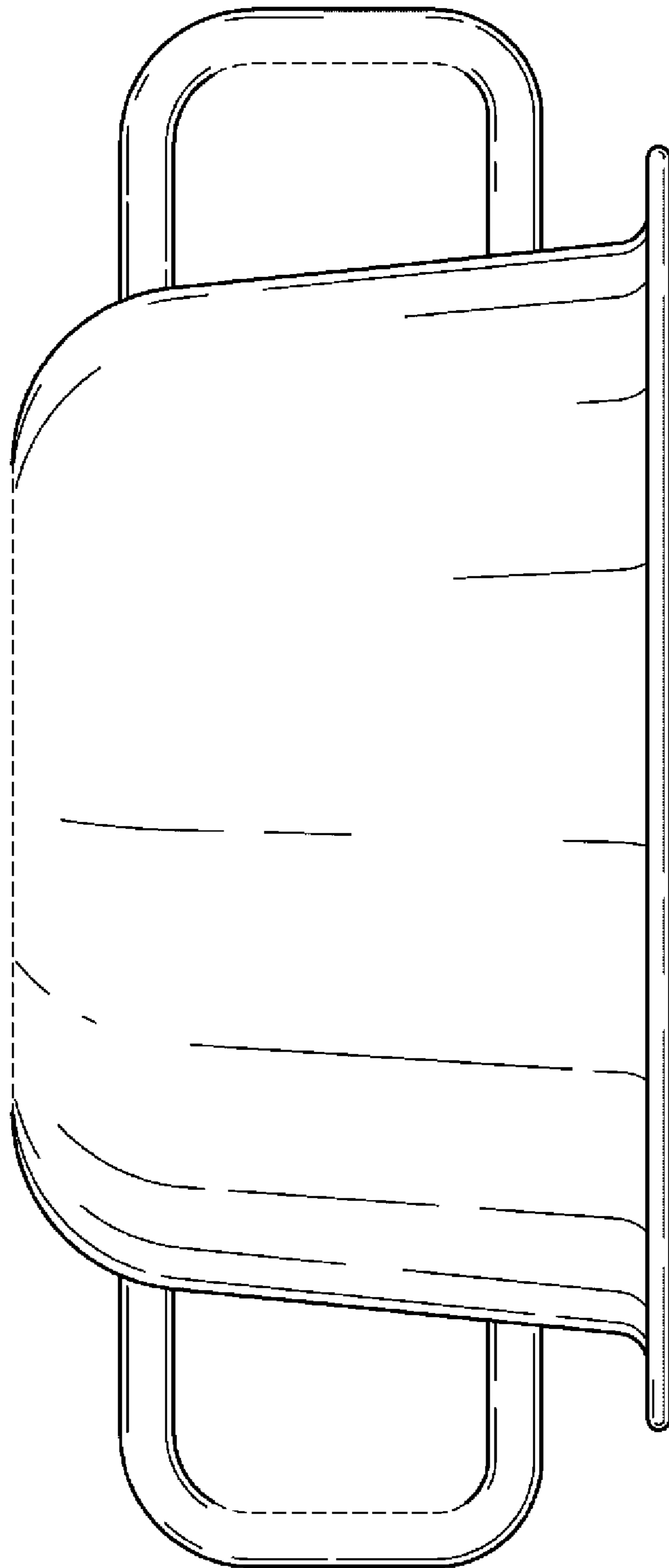
Sick Bear Bowl, as shown on Best Products Media Guide, [on-line];  
[retrieved from the Internet on Feb. 8, 2011]; URL: <http://

bestproductsmediaguide.info/product\_images/817/hi\_res.jpg>. (4  
pages; close-up shown on p. 4).\*

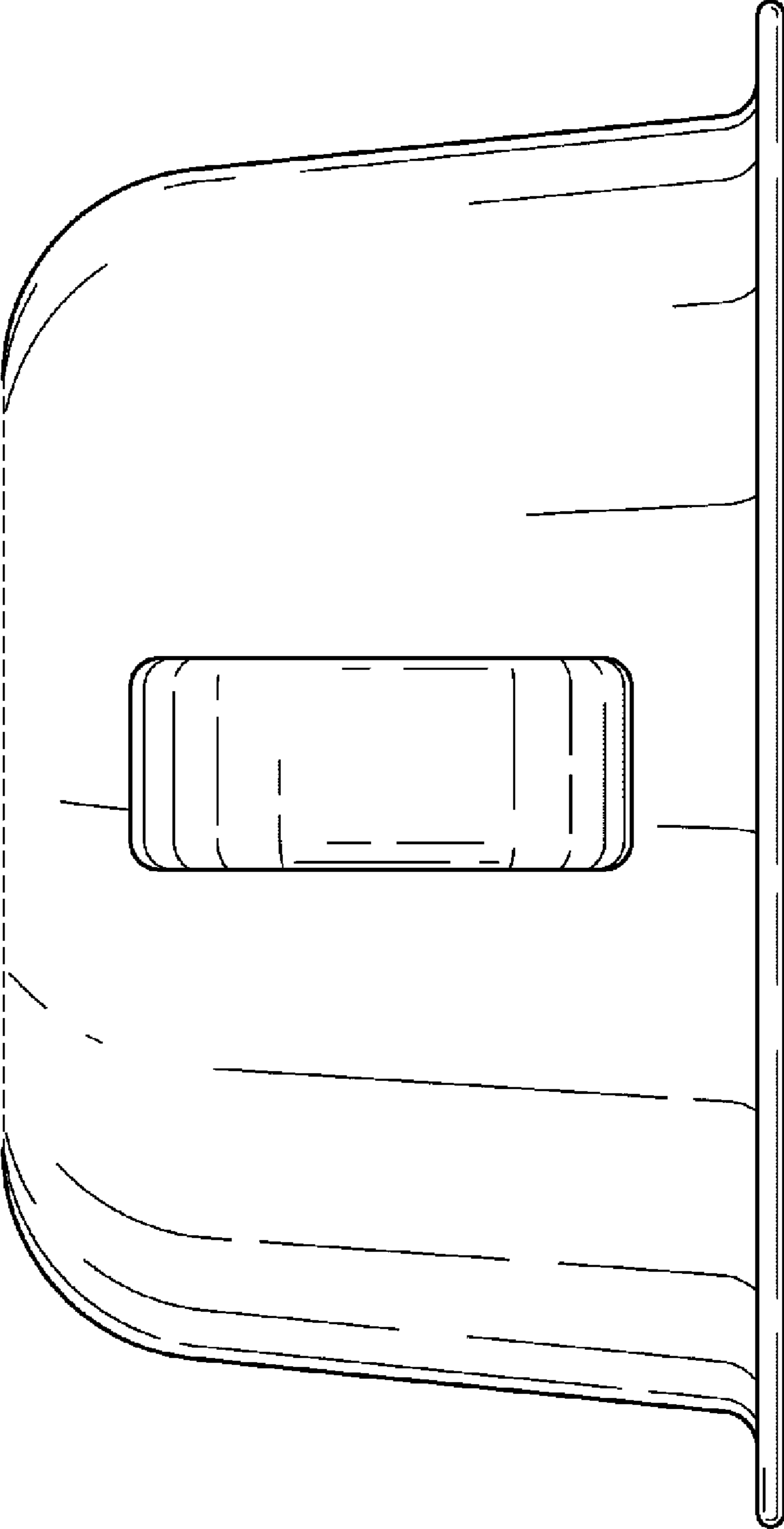
\* cited by examiner



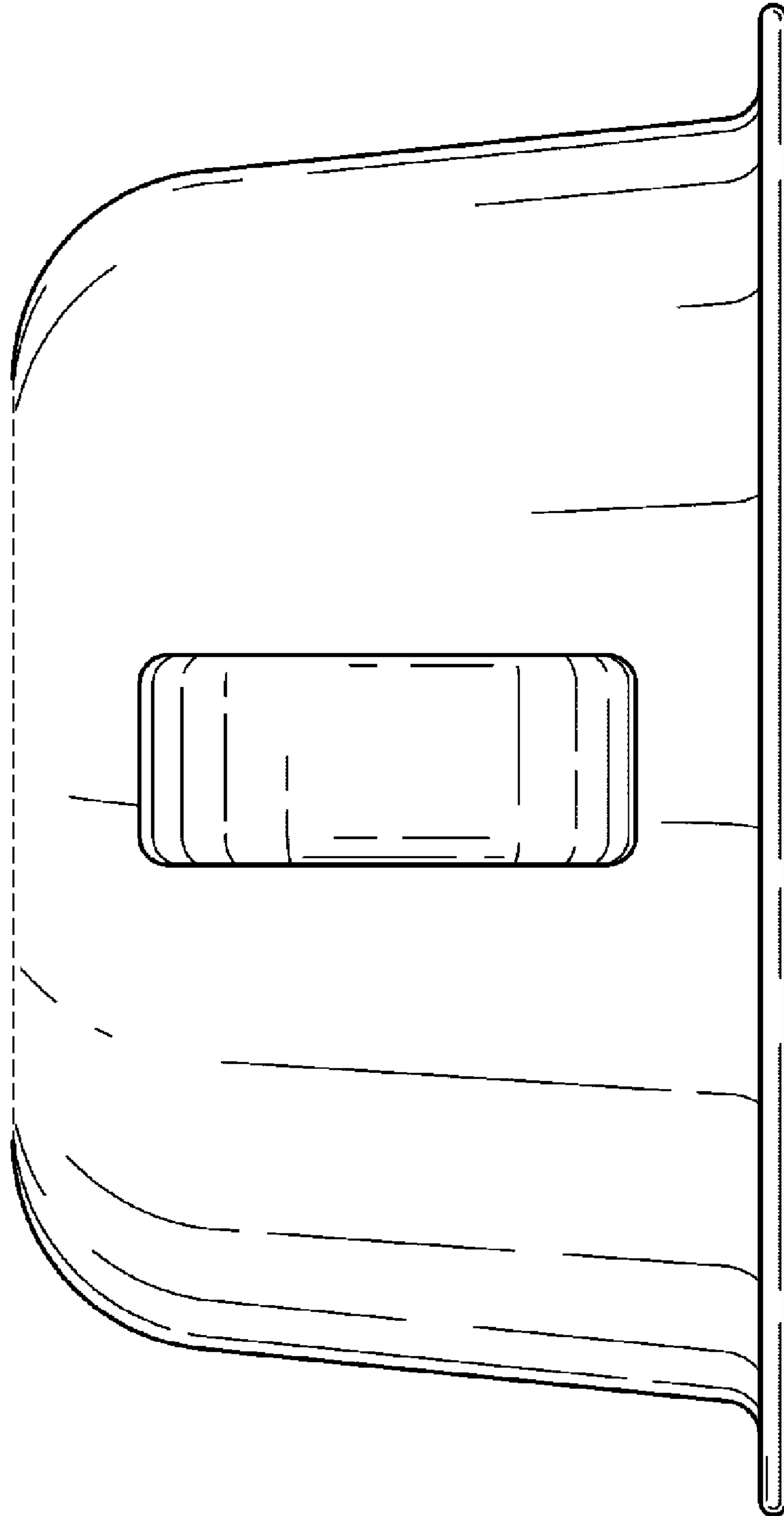
*Fig. 1*



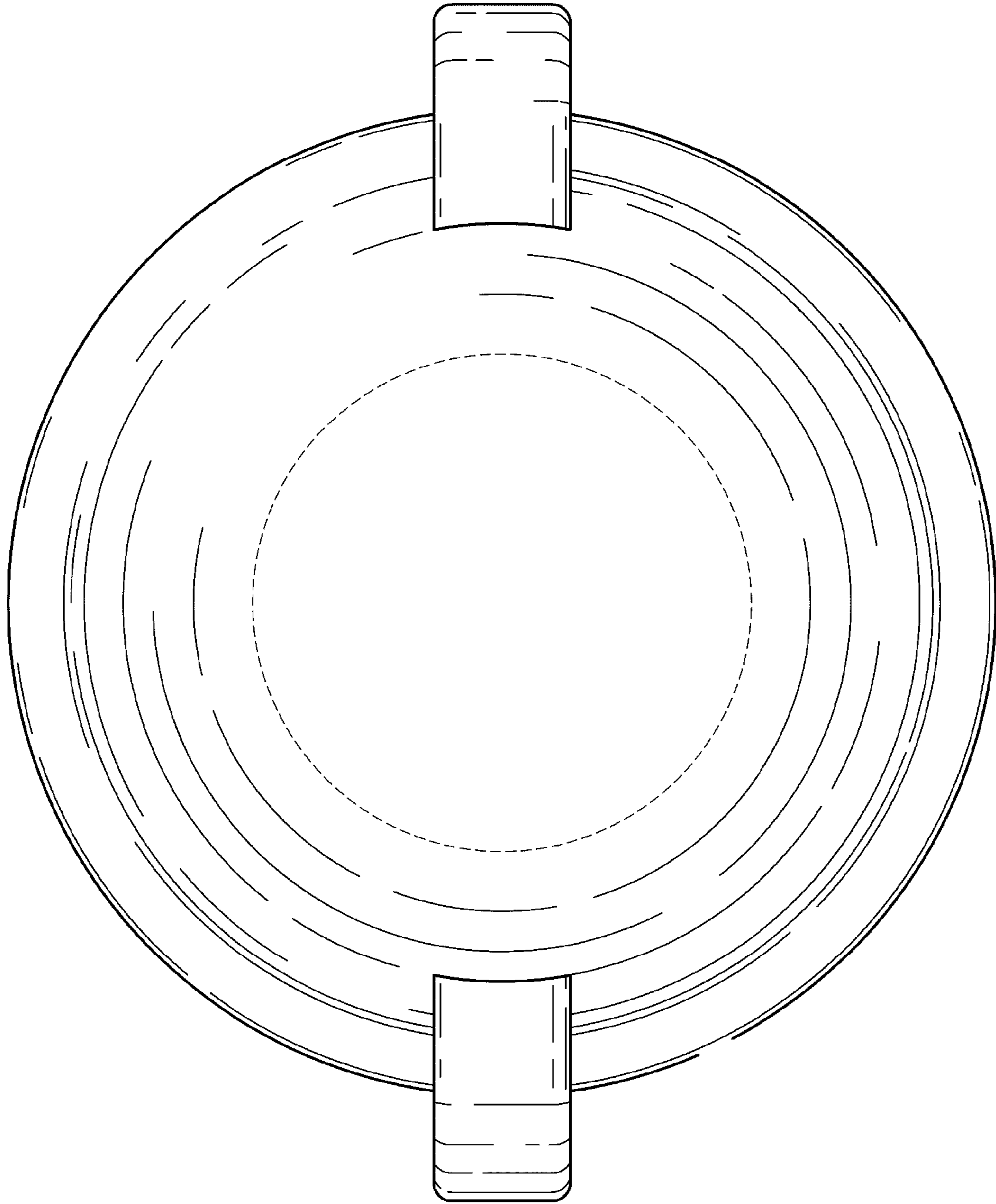
*Fig. 2*



*Fig. 3*

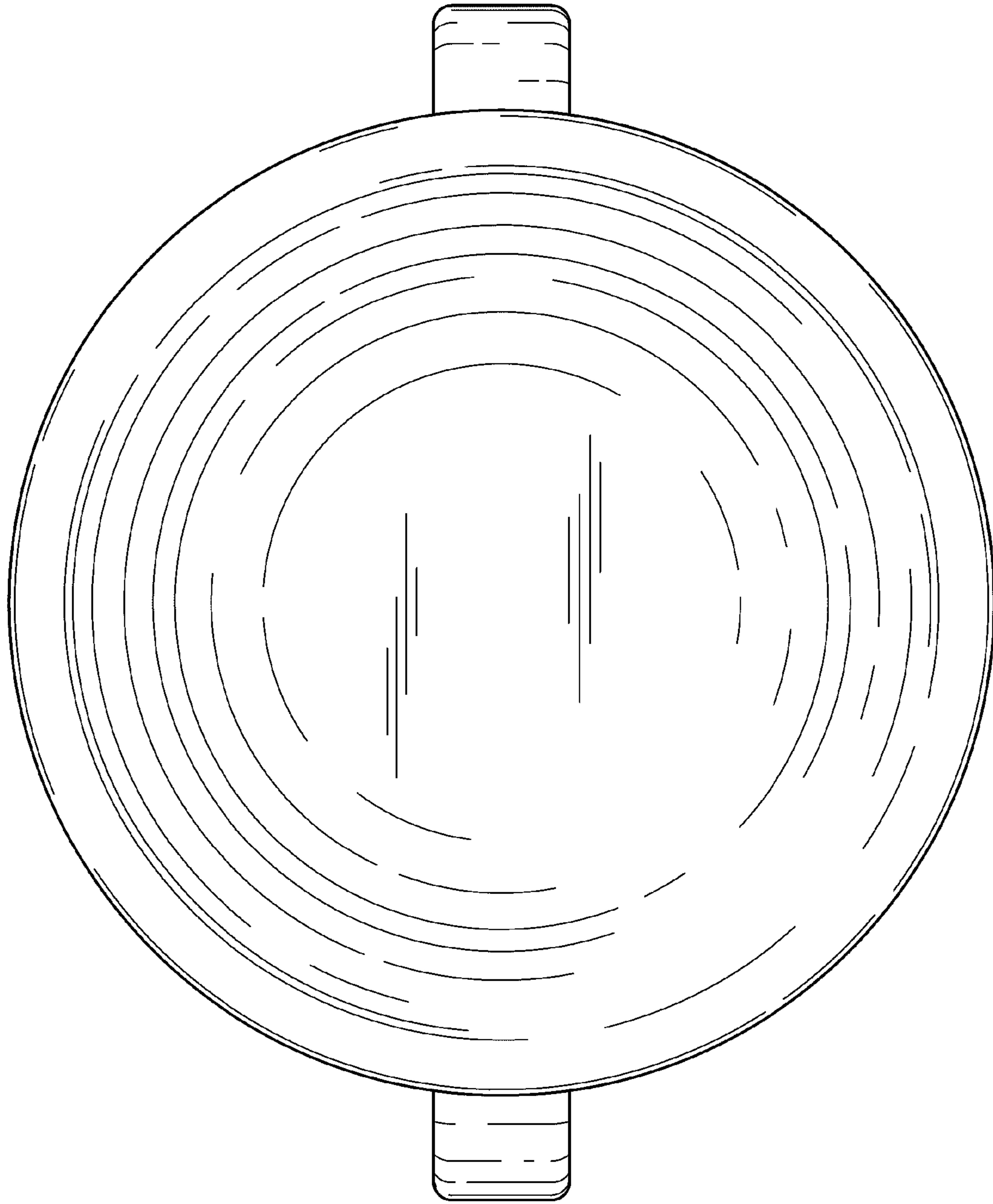


*Fig. 4*



*Fig. 5*





*Fig. 6*