



US00D647117S

(12) **United States Design Patent**  
**Omi**

(10) **Patent No.:** **US D647,117 S**

(45) **Date of Patent:** **\*\* Oct. 18, 2011**

(54) **HOLE CUTTER TIP**

(75) Inventor: **Shohei Omi**, Anjo (JP)

(73) Assignee: **Omi Kogyo Co., Ltd.**, Aichi-ken (JP)

(\*\*) Term: **14 Years**

(21) Appl. No.: **29/387,673**

(22) Filed: **Mar. 16, 2011**

(30) **Foreign Application Priority Data**

Sep. 30, 2010 (JP) ..... 2010-023457

(51) **LOC (9) Cl.** ..... **15-09**

(52) **U.S. Cl.** ..... **D15/139**

(58) **Field of Classification Search** ..... D8/16,  
D8/19, 20, 64, 66, 70, 90-99; D15/127,  
D15/133, 138, 139, 140; D22/117, 118;  
D24/146, 147; 7/118, 148; 30/142, 144,  
30/165, 166.3, 272.1, 314, 320, 346, 346.5,  
30/346.55, 346.56, 351, 355, 357, 346.6,  
30/349; 83/676, 835, 837-850; 403/331,  
403/381; 407/9, 33, 34, 42, 54, 63, 110,  
407/113, 114, 115; 408/204, 205, 224, 226-230  
See application file for complete search history.

(56) **References Cited**

**U.S. PATENT DOCUMENTS**

|           |     |         |                    |          |
|-----------|-----|---------|--------------------|----------|
| 3,154,839 | A * | 11/1964 | Kleber, Jr. et al. | 83/661   |
| 3,176,732 | A * | 4/1965  | Henderson          | 83/852   |
| 4,208,154 | A * | 6/1980  | Gundy              | 408/204  |
| 5,007,775 | A * | 4/1991  | Pantzar            | 407/113  |
| 5,218,888 | A * | 6/1993  | Merrill            | 76/108.1 |
| D481,045  | S * | 10/2003 | Ahn                | D15/139  |
| D541,831  | S * | 5/2007  | Miyanaga           | D15/139  |
| D560,699  | S   | 1/2008  | Omi                |          |
| D595,751  | S * | 7/2009  | Sakata et al.      | D15/139  |
| D616,003  | S * | 5/2010  | Ueda et al.        | D15/139  |

|              |      |         |               |          |
|--------------|------|---------|---------------|----------|
| 2001/0051075 | A1 * | 12/2001 | Focken et al. | 407/34   |
| 2007/0257544 | A1 * | 11/2007 | Baker et al.  | 299/81.2 |
| 2009/0052997 | A1 * | 2/2009  | Shimizu       | 407/34   |

**FOREIGN PATENT DOCUMENTS**

|    |        |        |
|----|--------|--------|
| JP | 608009 | 9/1983 |
| JP | 670050 | 1/1986 |
| JP | 701393 | 3/1987 |

(Continued)

**OTHER PUBLICATIONS**

Application and File History of U.S. Appl. No. 29/387,670, Inventor Shohei Omi, filed Mar. 16, 2011.

(Continued)

*Primary Examiner* — Patricia Palasik

(74) *Attorney, Agent, or Firm* — Patterson Thuent Christensen Pedersen P.A.

(57) **CLAIM**

The ornamental design for a hole cutter tip, as shown and described.

**DESCRIPTION**

FIG. 1 is a front perspective view of a hole cutter tip showing my new design;  
FIG. 2 is a rear perspective view thereof;  
FIG. 3 is a front view thereof;  
FIG. 4 is a rear view thereof;  
FIG. 5 is a top plan view thereof;  
FIG. 6 is a bottom plan view thereof;  
FIG. 7 is a right side view thereof;  
FIG. 8 is a left side view thereof;  
FIG. 9 is an enlarged cross-sectional view taken along line 9-9 in FIG. 3; and,  
FIG. 10 is a referential perspective view of the front and rear of a hole cutter tip showing the article in use in broken lines. The broken lines are shown for illustrative purposes only and form no part of the claimed design.

**1 Claim, 4 Drawing Sheets**

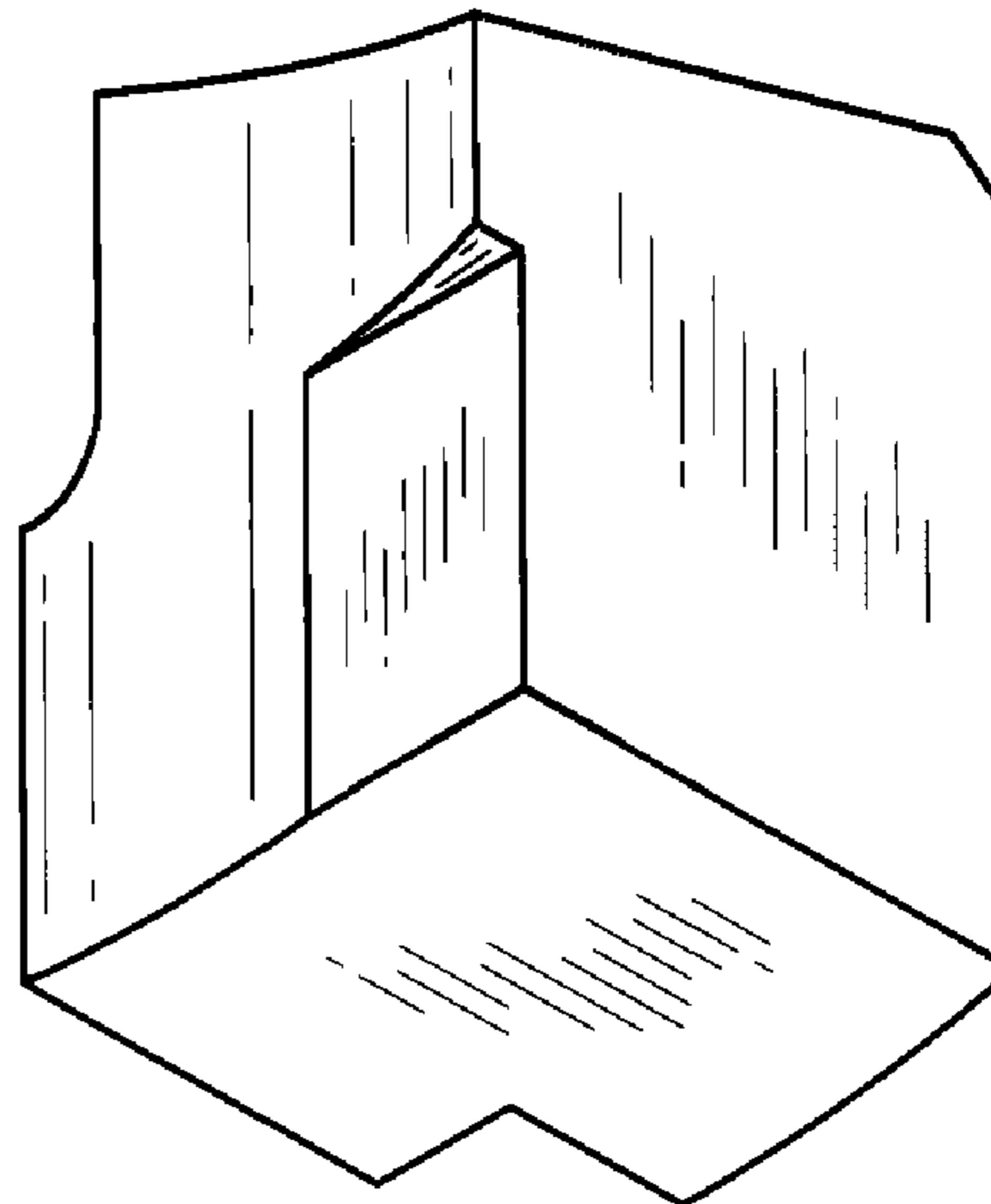
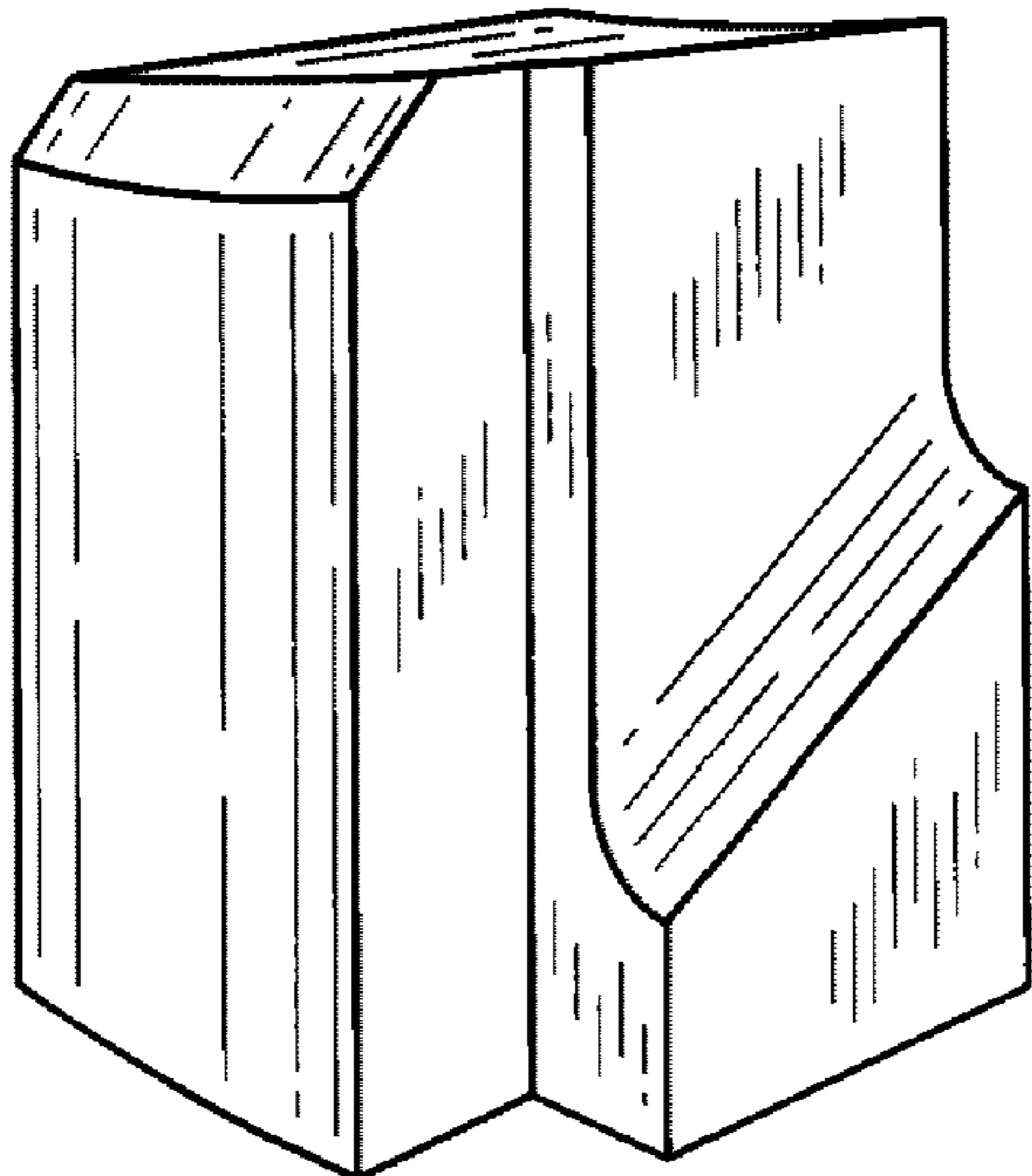

# US D647,117 S

Page 2

---

## FOREIGN PATENT DOCUMENTS

|    |           |         |
|----|-----------|---------|
| JP | 938384    | 11/1995 |
| JP | 938385    | 11/1995 |
| JP | 938390    | 11/1995 |
| JP | 938392    | 11/1995 |
| JP | 938396    | 11/1995 |
| JP | 938397    | 11/1995 |
| JP | 938409    | 11/1995 |
| JP | 8-11096   | 1/1996  |
| JP | 616242-14 | 5/1997  |
| JP | 1082709   | 8/2000  |
| JP | 1259039   | 12/2005 |

|    |                   |         |
|----|-------------------|---------|
| JP | 1320279           | 1/2008  |
| JP | 1320413           | 1/2008  |
| JP | 1320414           | 1/2008  |
| JP | 1320415           | 1/2008  |
| JP | 1320416           | 1/2008  |
| WO | WO 2004/108333 A1 | 12/2004 |

## OTHER PUBLICATIONS

Application and File History of U.S. Appl. No. 29/387,677, Inventor Shohei Omi, filed Mar. 16, 2011.

\* cited by examiner

**Fig. 1**

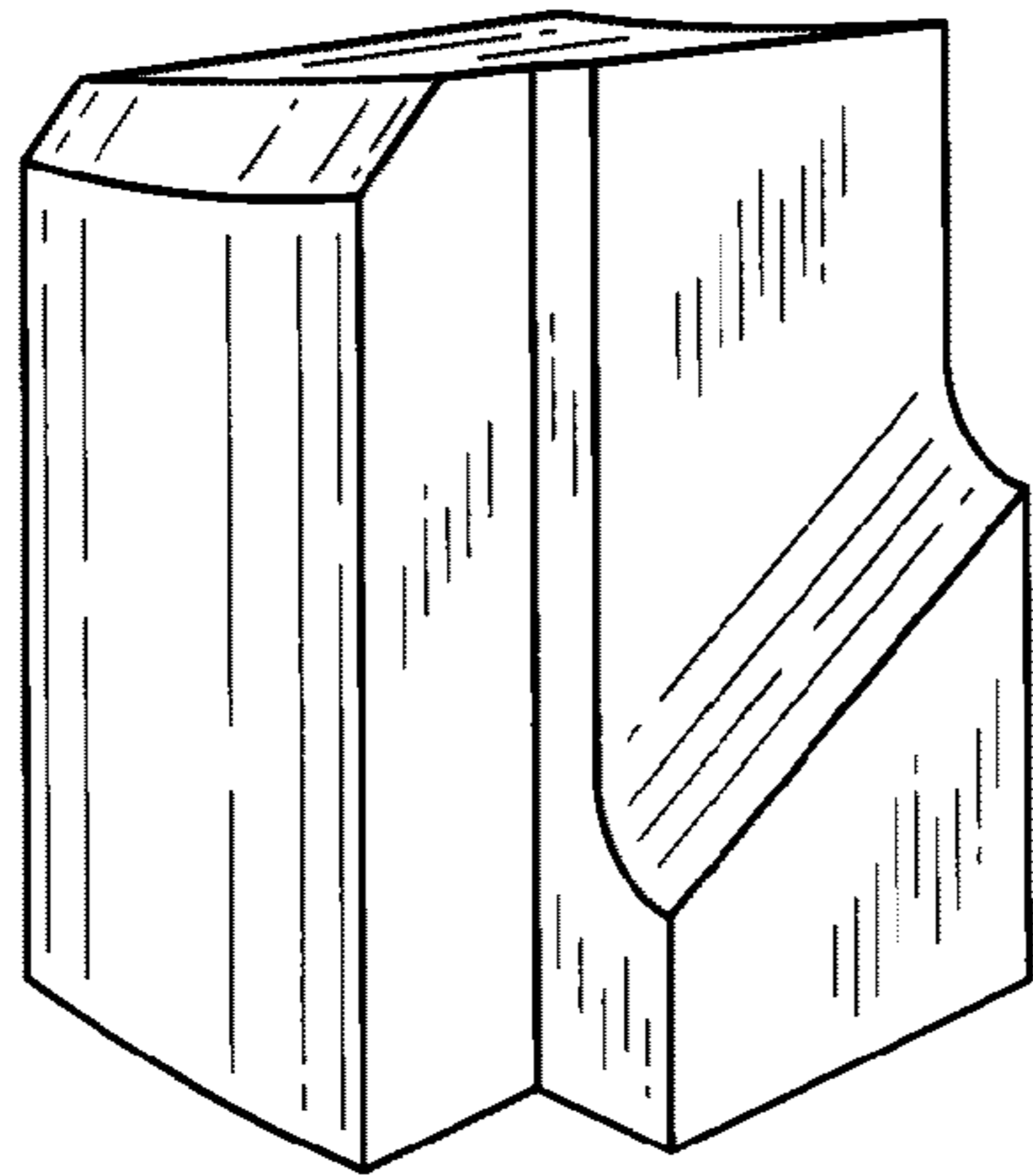

**Fig. 2**

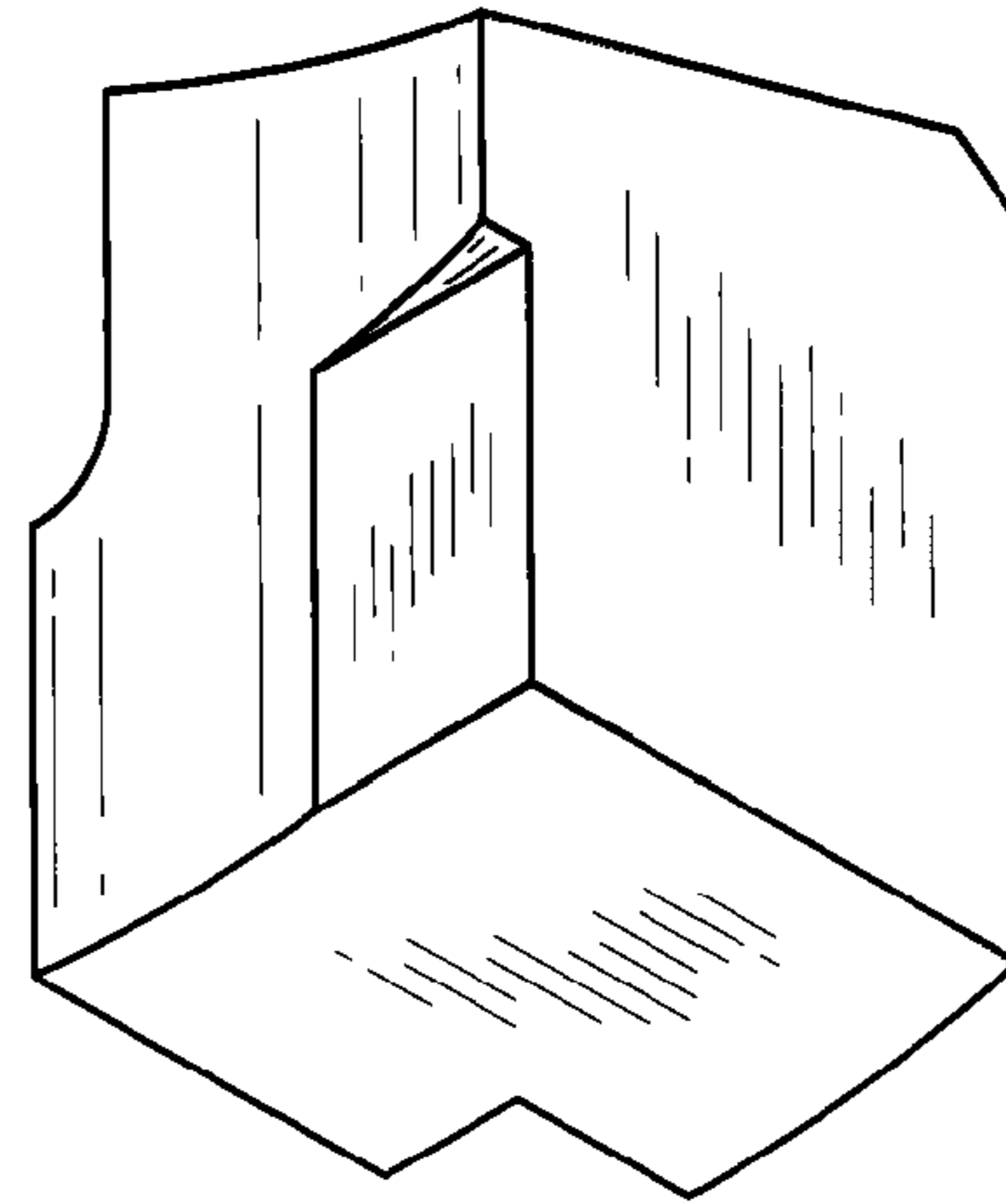

**Fig. 3**

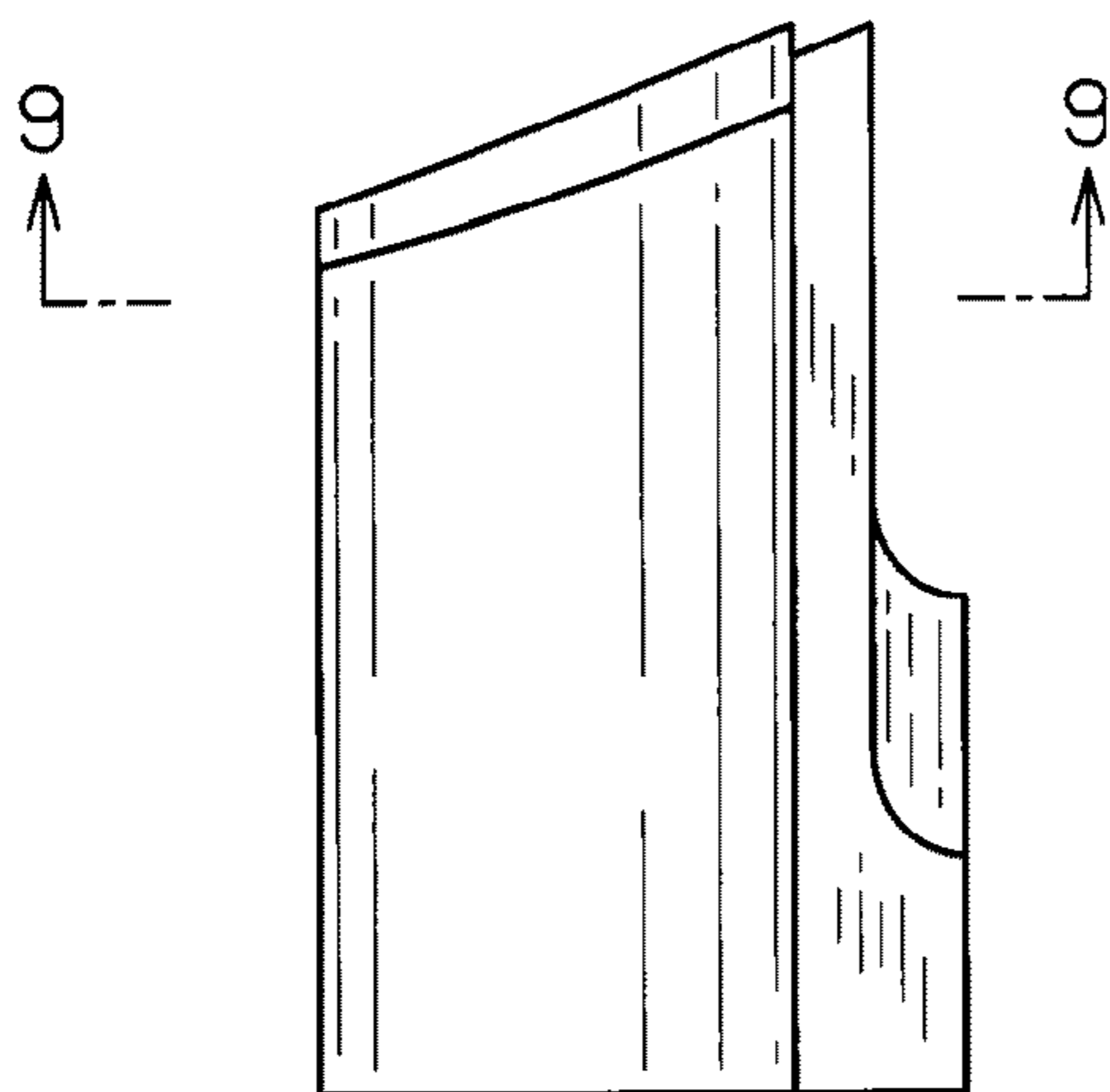

**Fig. 4**

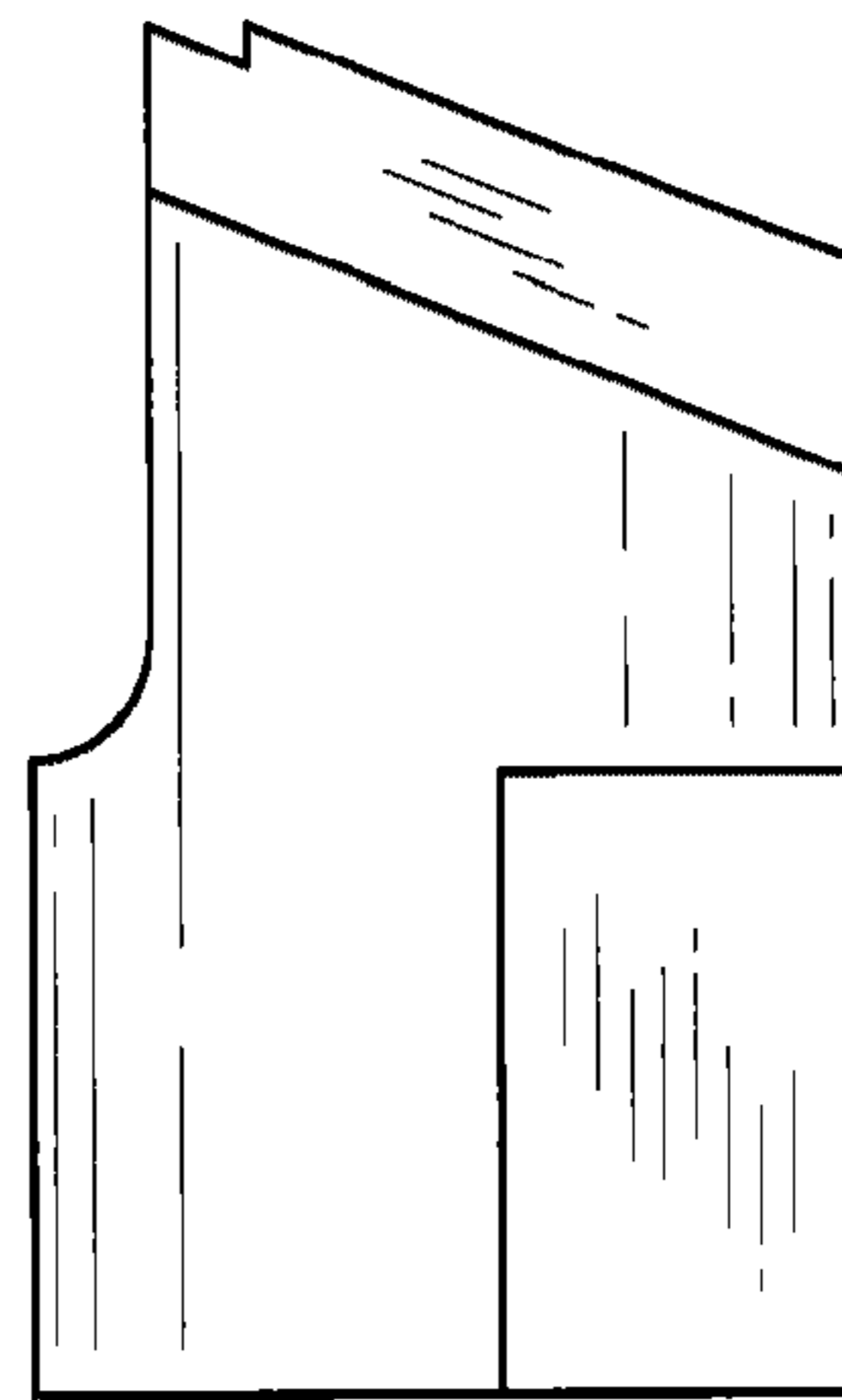

**Fig. 5**

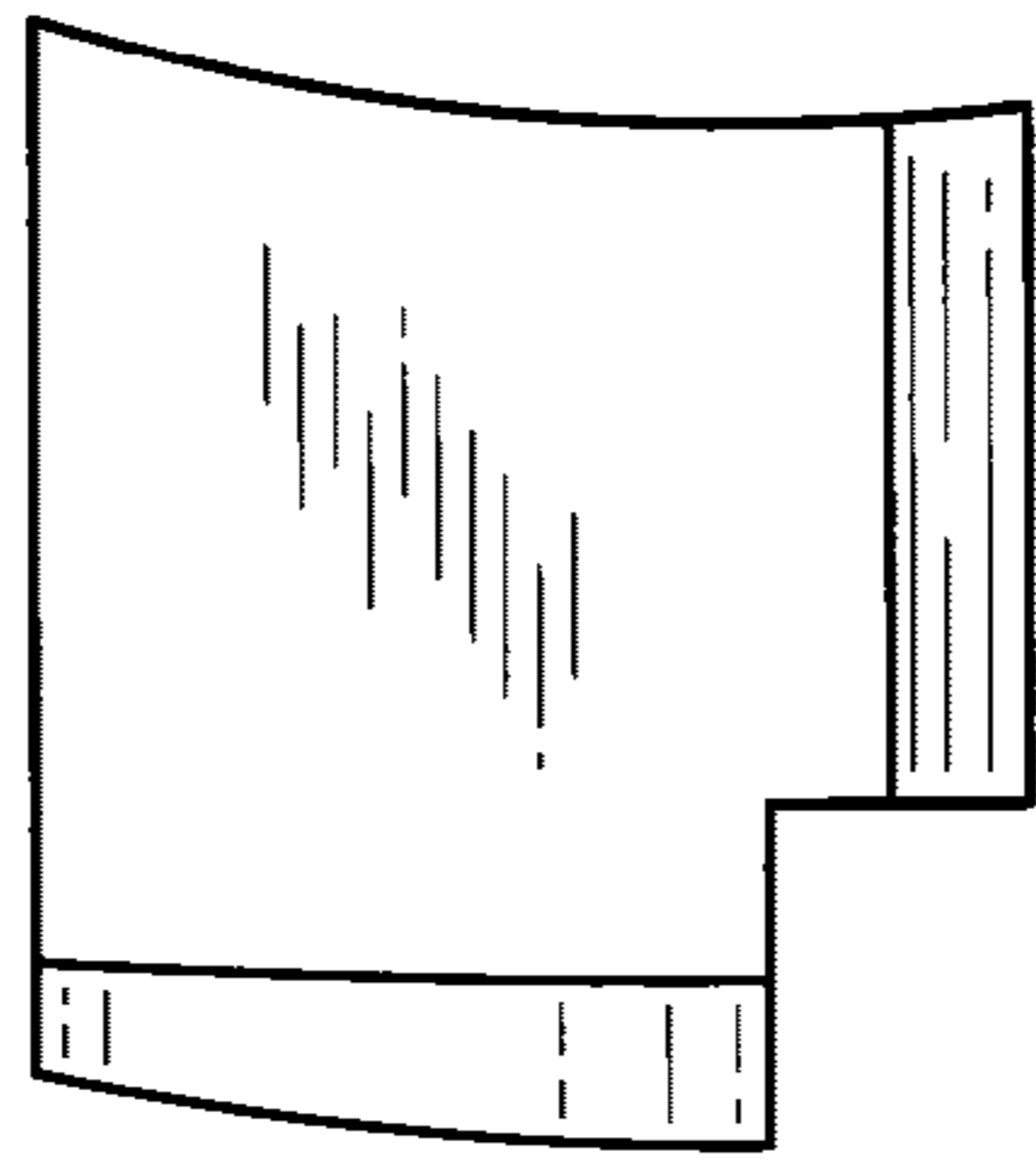

**Fig. 6**

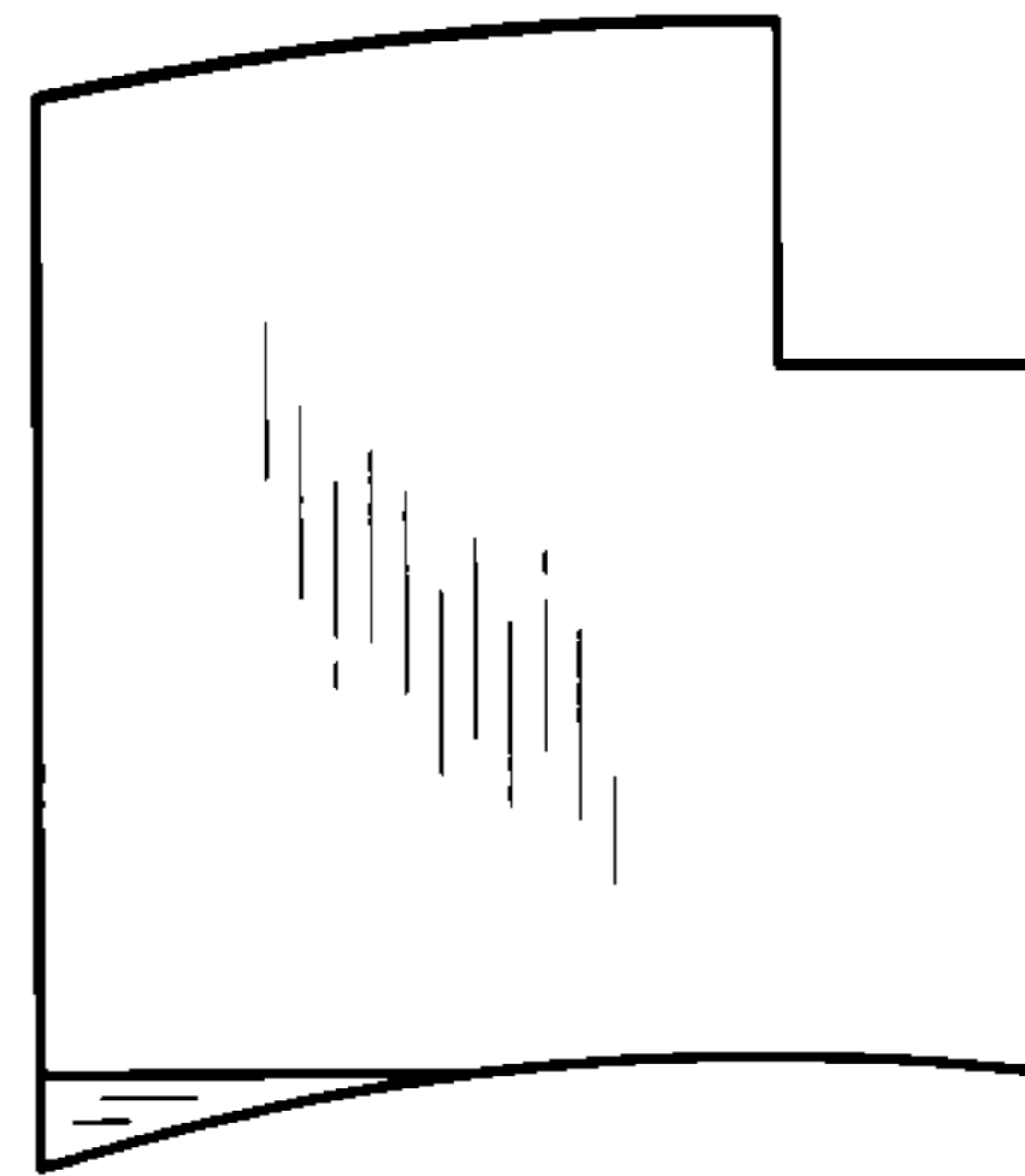

**Fig. 7**

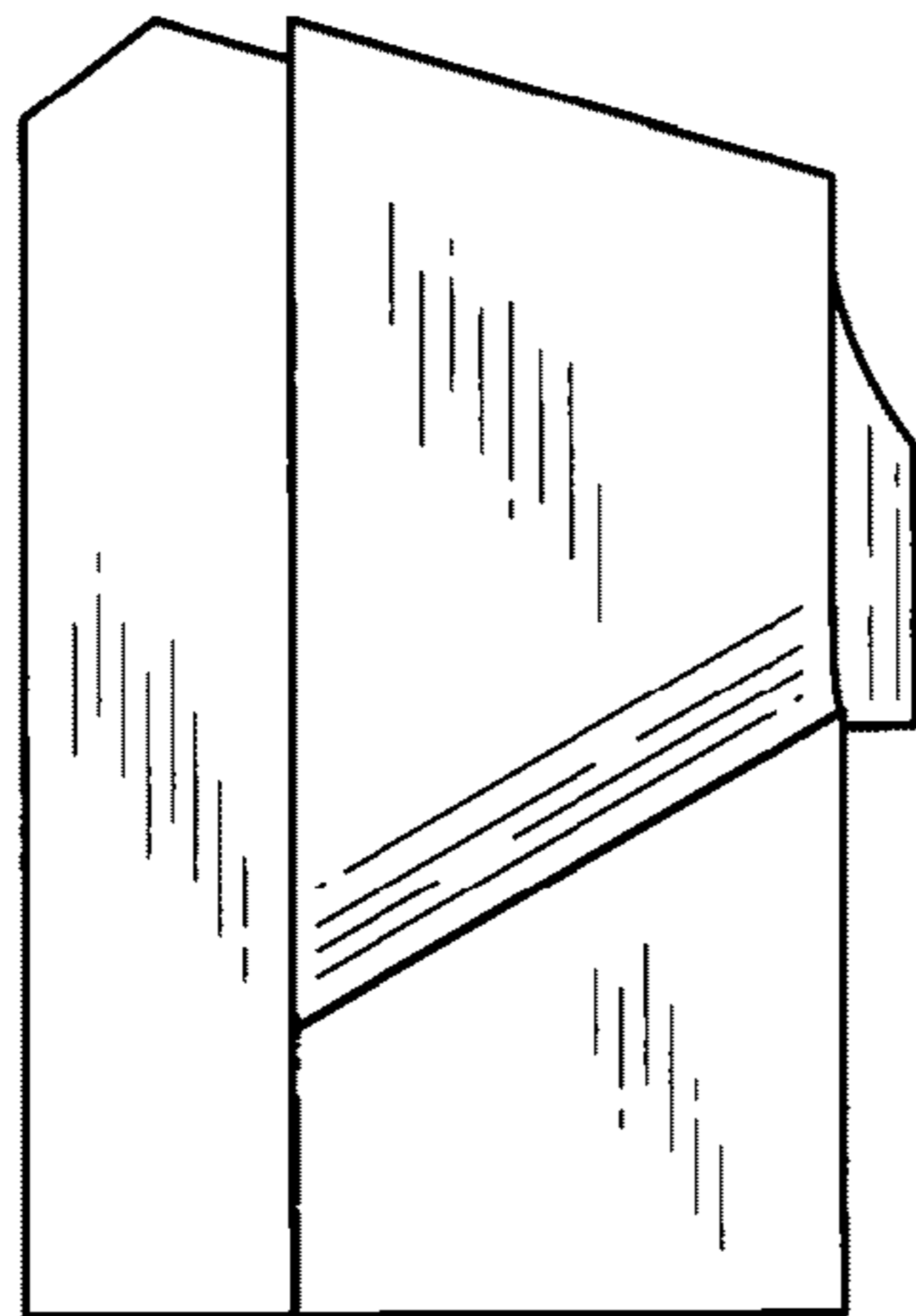

**Fig. 8**

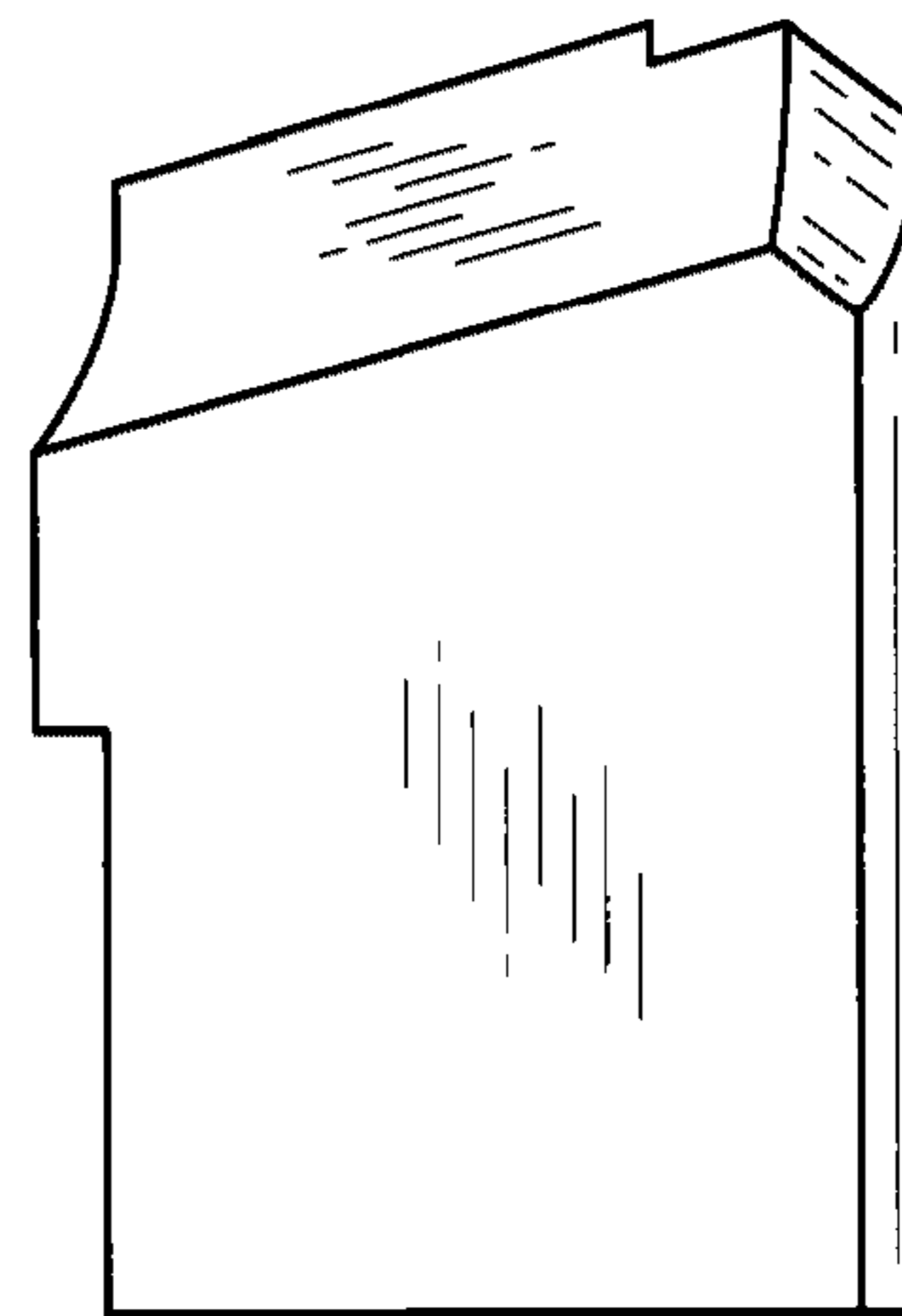

**Fig. 9**

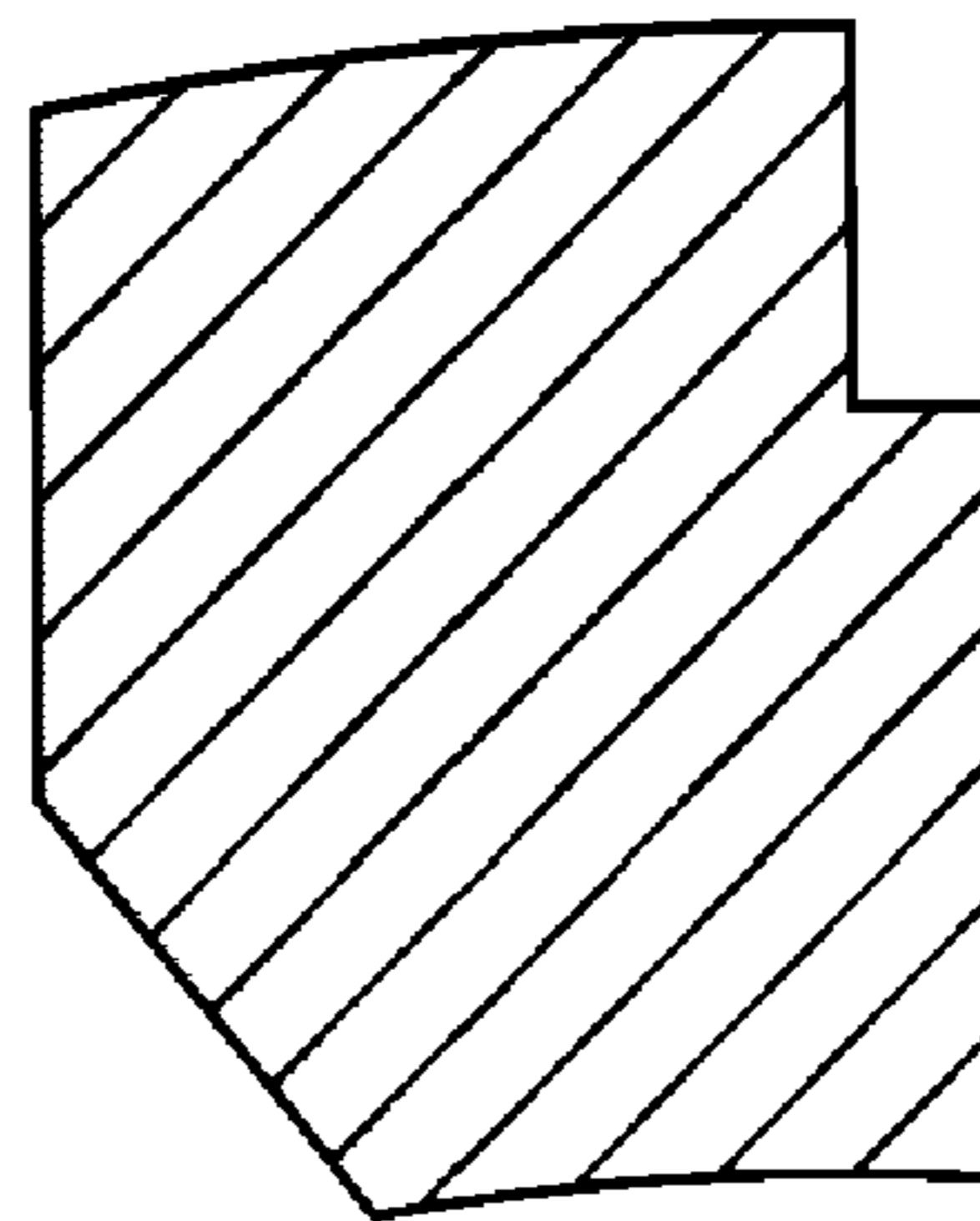

**Fig.10**

