



US00D647116S

(12) **United States Design Patent**
Omi

(10) **Patent No.:** **US D647,116 S**

(45) **Date of Patent:** **** Oct. 18, 2011**

(54) **HOLE CUTTER TIP**

(75) Inventor: **Shohei Omi**, Anjo (JP)

(73) Assignee: **Omi Kogyo Co., Ltd.**, Aichi-ken (JP)

(**) Term: **14 Years**

(21) Appl. No.: **29/387,670**

(22) Filed: **Mar. 16, 2011**

(30) **Foreign Application Priority Data**

Sep. 30, 2010 (JP) 2010-023456

(51) **LOC (9) Cl.** **15-09**

(52) **U.S. Cl.** **D15/139**

(58) **Field of Classification Search** D8/16,
D8/19, 20, 64, 66, 70, 90-99; D15/127,
D15/133, 138, 139, 140; D22/117, 118;
D24/146, 147; 7/118, 148; 30/142, 144,
30/165, 166.3, 272.1, 314, 320, 346, 346.5,
30/346.55, 346.56, 346.6, 349, 351, 355,
30/357; 83/676, 835, 837-850; 403/331,
403/381; 407/9, 33, 34, 42, 54, 63, 110,
407/113, 114, 115; 408/204, 205, 224, 226-230
See application file for complete search history.

(56) **References Cited**

U.S. PATENT DOCUMENTS

3,154,839 A * 11/1964 Kleber, Jr. et al. 83/661
3,176,732 A * 4/1965 Henderson 83/852
4,208,154 A * 6/1980 Gundy 408/204
5,007,775 A * 4/1991 Pantzar 407/113
5,218,888 A * 6/1993 Merrill 76/108.1
D481,045 S * 10/2003 Ahn D15/139
D541,831 S * 5/2007 Miyanaga D15/139
D560,699 S 1/2008 Omi
D595,751 S * 7/2009 Sakata et al. D15/139
D616,003 S * 5/2010 Ueda et al. D15/139

2001/0051075 A1* 12/2001 Focken et al. 407/34
2007/0257544 A1* 11/2007 Baker et al. 299/81.2
2009/0052997 A1* 2/2009 Shimizu 407/34

FOREIGN PATENT DOCUMENTS

JP 608009 9/1983

(Continued)

OTHER PUBLICATIONS

Application and File History of U.S. Appl. No. 29/387,673, Inventor Shohei Omi, filed Mar. 16, 2011, www.uspto.gov.

(Continued)

Primary Examiner — Patricia Palasik

(74) *Attorney, Agent, or Firm* — Patterson Thuent Christensen Pedersen P.A.

(57) **CLAIM**

The ornamental design for a hole cutter tip, as shown and described.

DESCRIPTION

FIG. 1 is a front perspective view of a hole cutter tip showing my new design;

FIG. 2 is a rear perspective view thereof;

FIG. 3 is a front view thereof;

FIG. 4 is a rear view thereof;

FIG. 5 is a top plan view thereof;

FIG. 6 is a bottom plan view thereof;

FIG. 7 is a right side view thereof;

FIG. 8 is a left side view thereof;

FIG. 9 is an enlarged cross-sectional view taken along line 9-9 in FIG. 3; and,

FIG. 10 is a referential perspective view of the front and rear of an identical hole cutter tip showing the tip in use on a hole cutter shown in broken lines.

The broken lines are shown for illustrative purposes only and form no part of the claimed design.

1 Claim, 4 Drawing Sheets

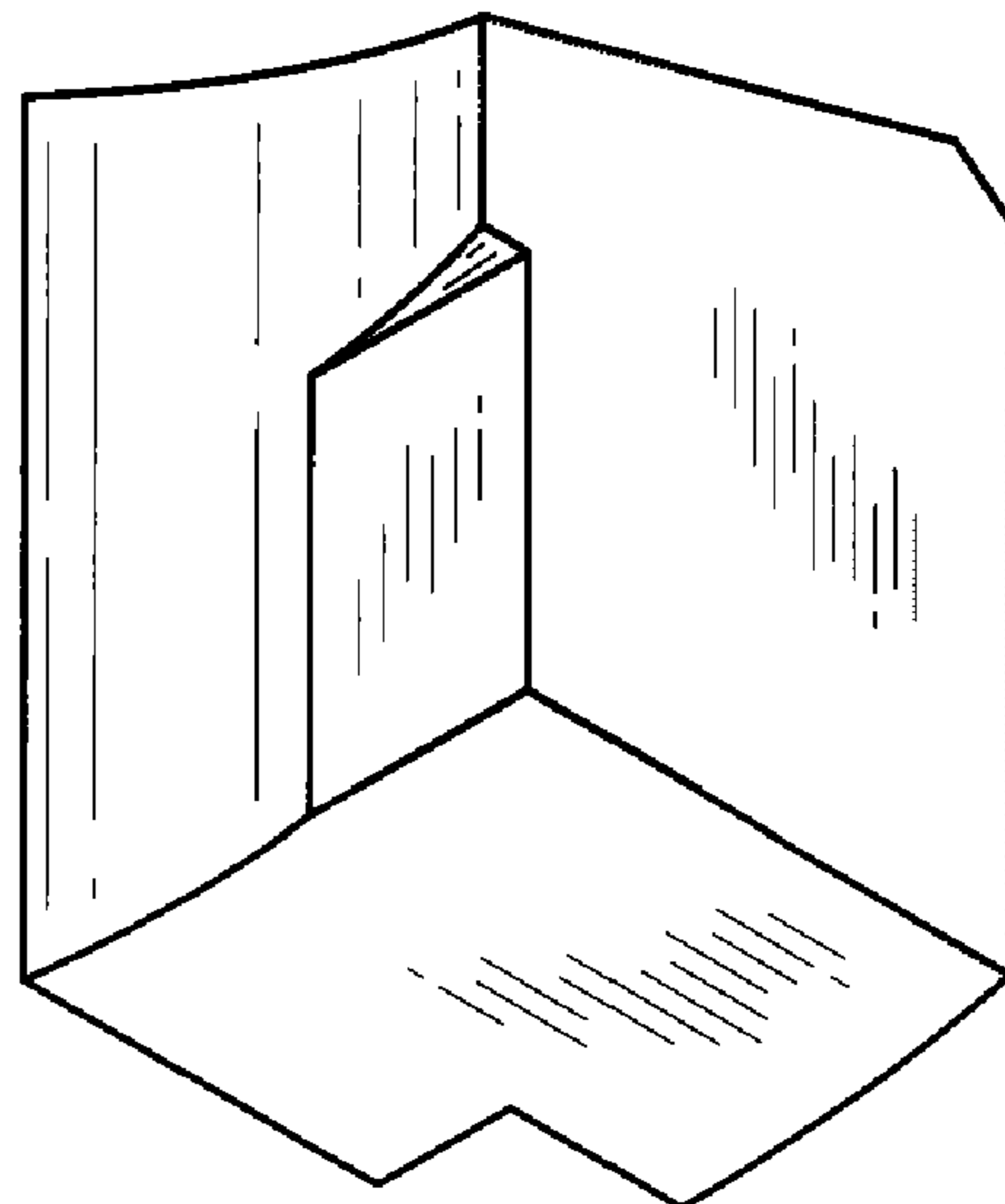
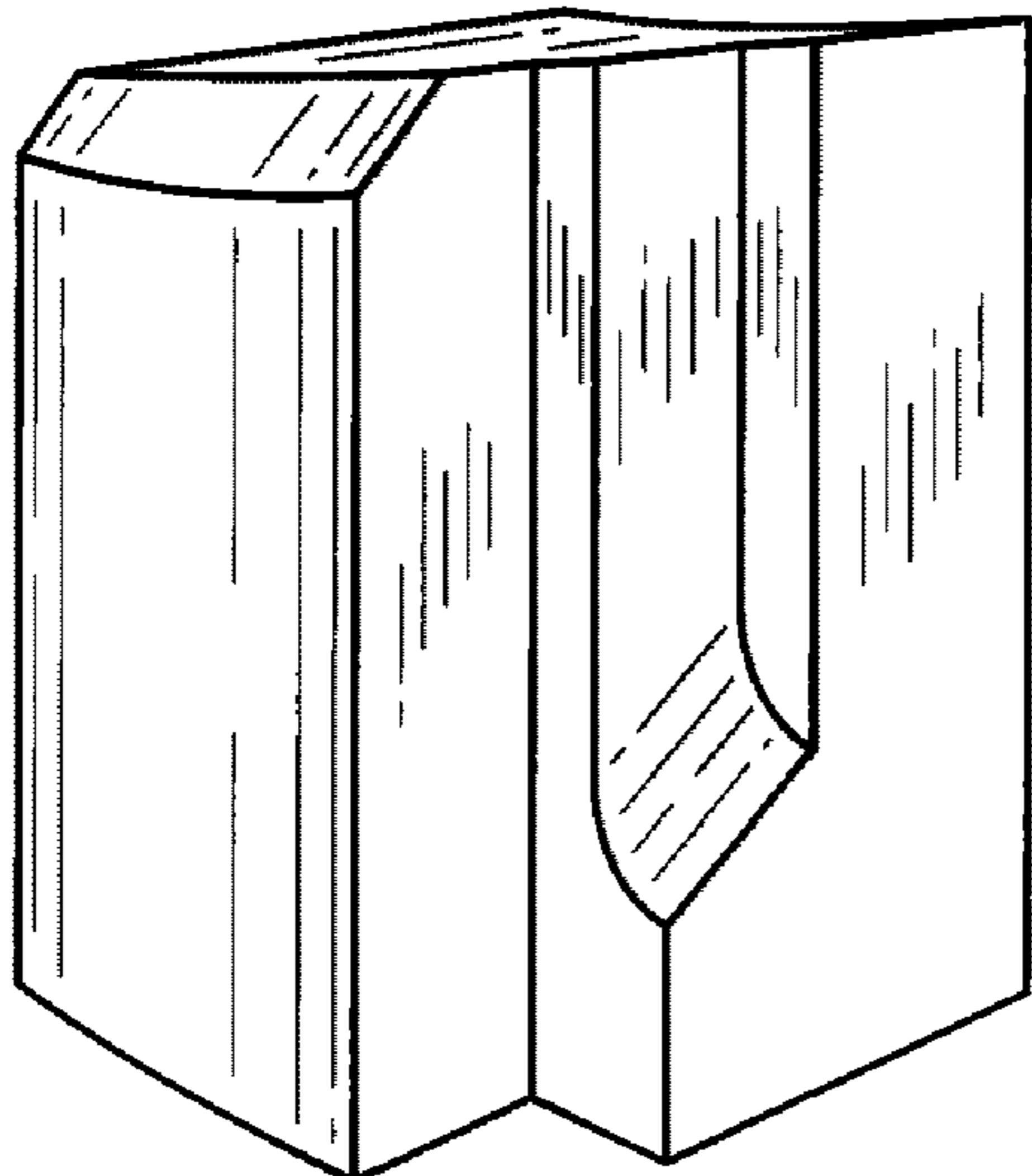

US D647,116 S

Page 2

FOREIGN PATENT DOCUMENTS		
JP	670050	1/1986
JP	701393	3/1987
JP	938384	11/1995
JP	938385	11/1995
JP	938390	11/1995
JP	938392	11/1995
JP	938396	11/1995
JP	938397	11/1995
JP	938409	11/1995
JP	8-11096	1/1996
JP	616242-14	5/1997
JP	1082709	8/2000

JP	1259039	12/2005
JP	1320279	1/2008
JP	1320413	1/2008
JP	1320414	1/2008
JP	1320415	1/2008
JP	1320416	1/2008
WO	WO 2004/108333 A1	12/2004

OTHER PUBLICATIONS

Application and File History of U.S. Appl. No. 29/387,677, Inventor Shohei Omi, filed Mar. 16, 2011, www.uspto.gov.

* cited by examiner

Fig. 1

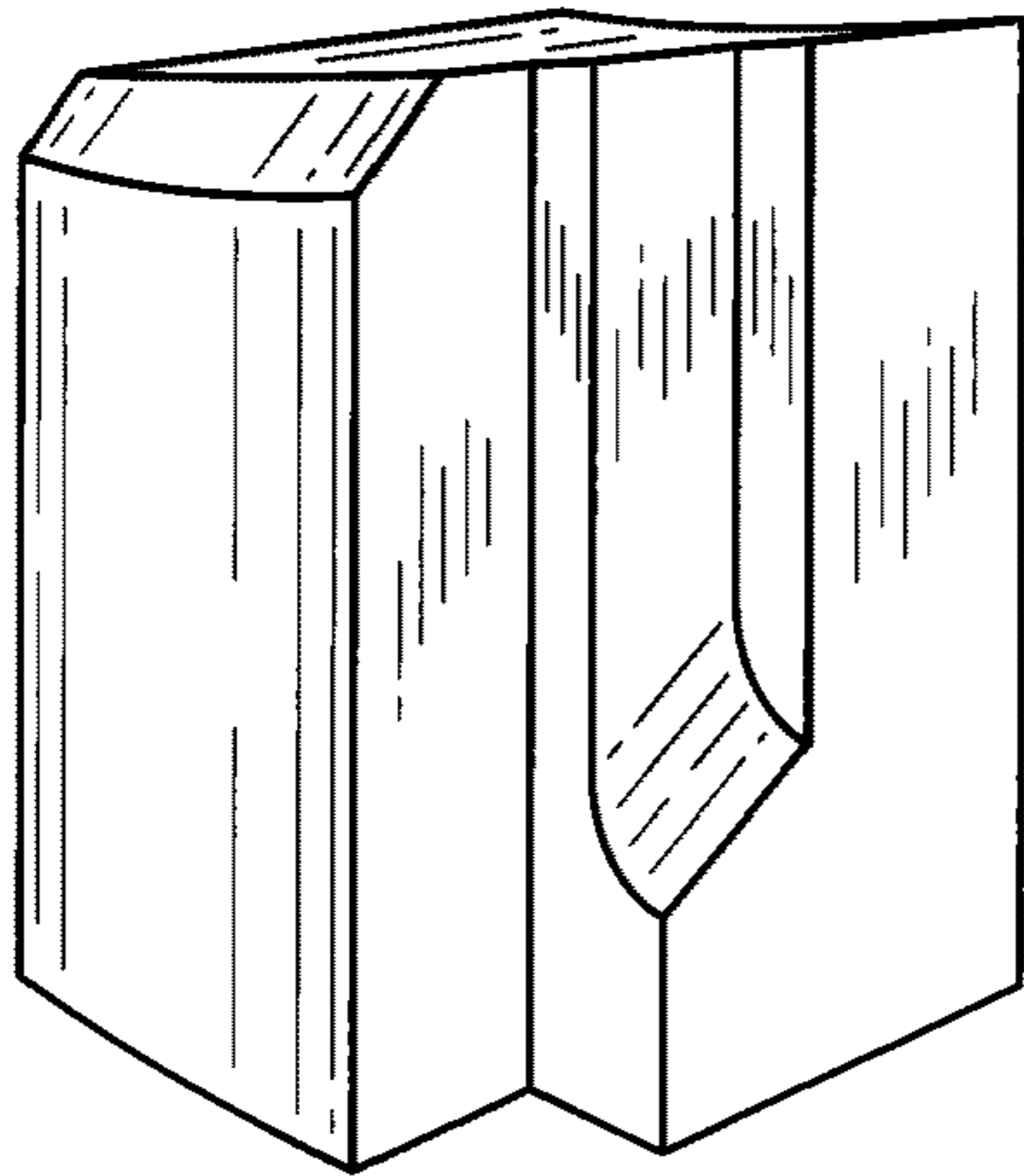

Fig. 2

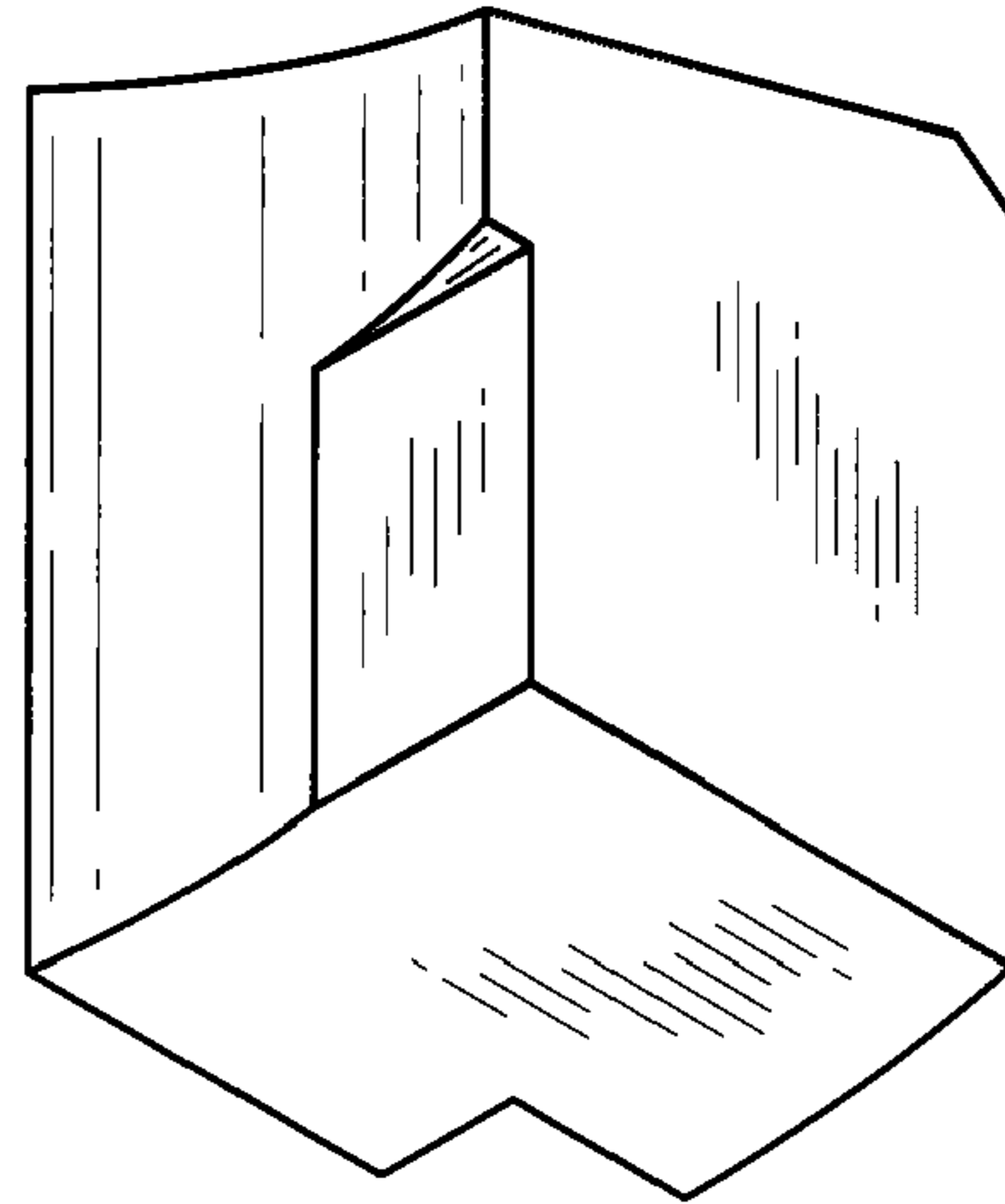

Fig. 3

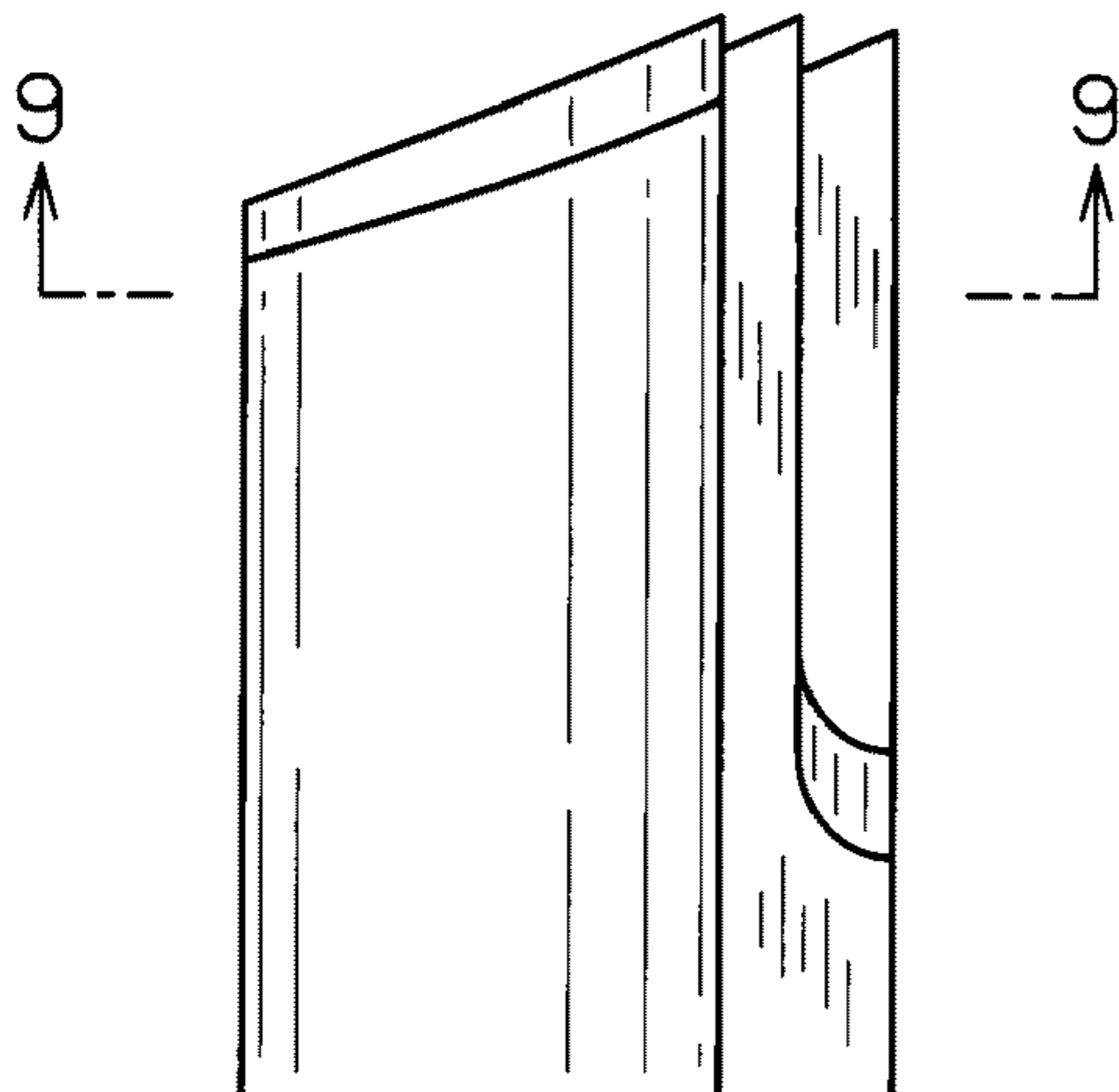

Fig. 4

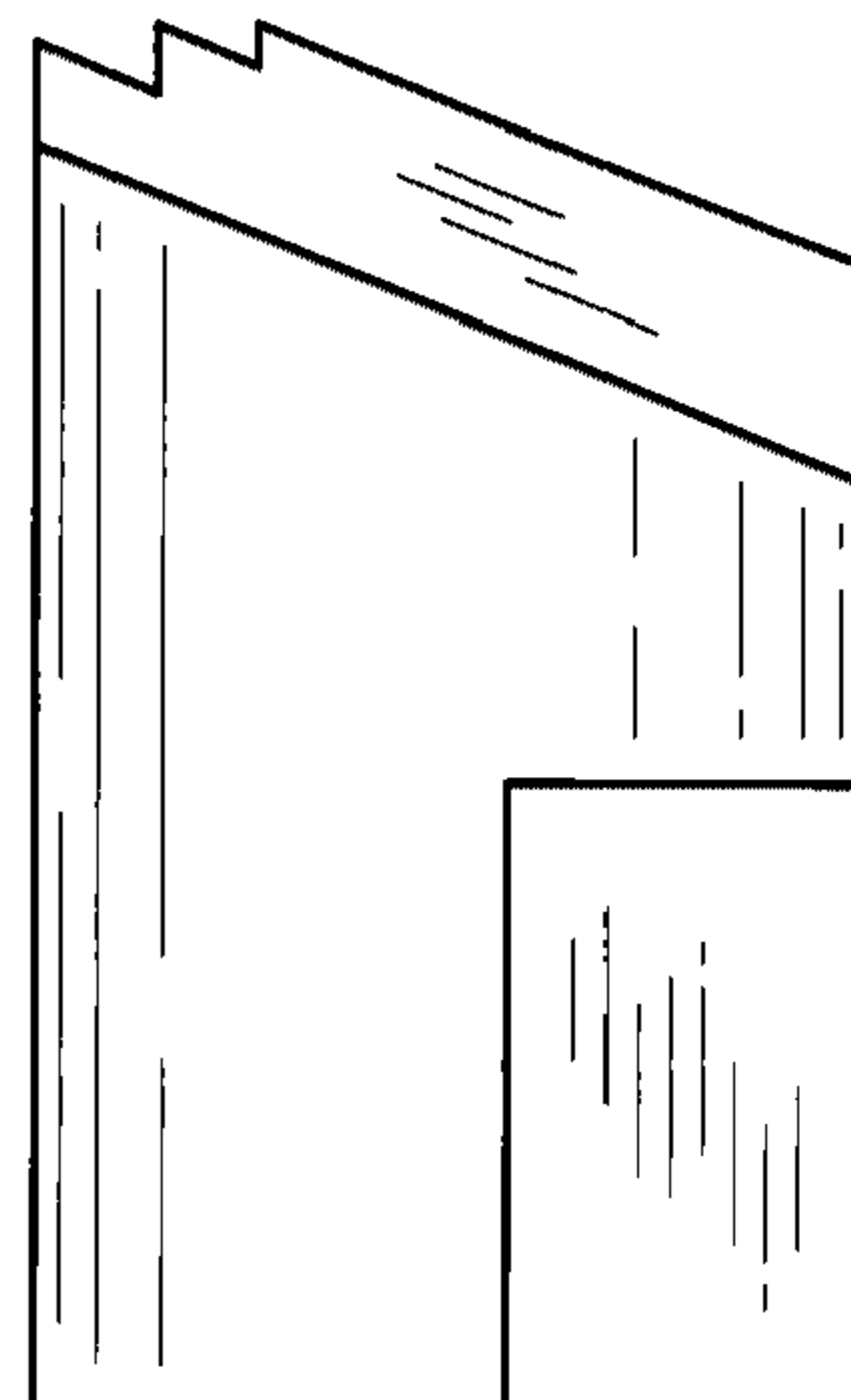

Fig. 5

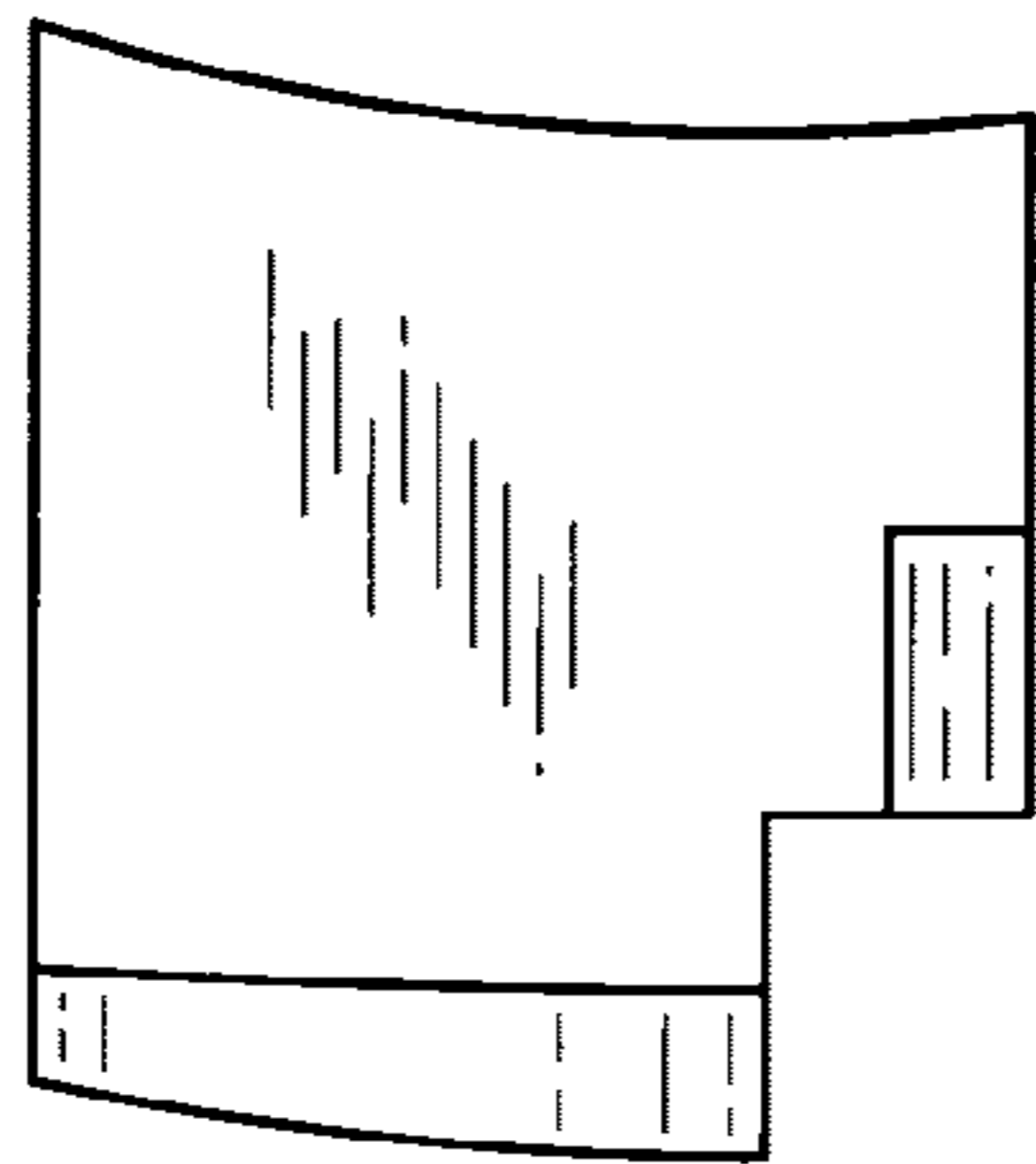

Fig. 6

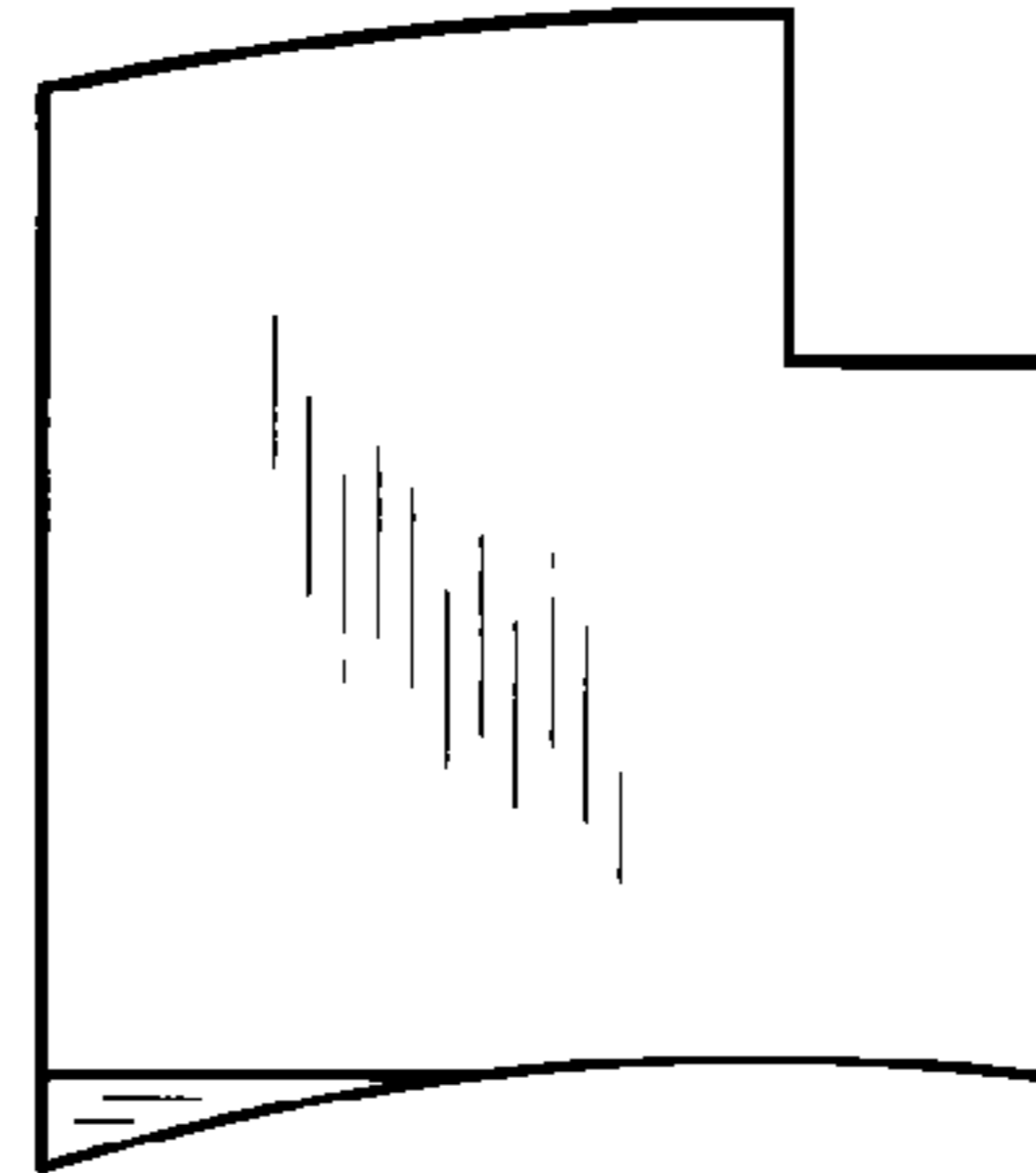

Fig. 7

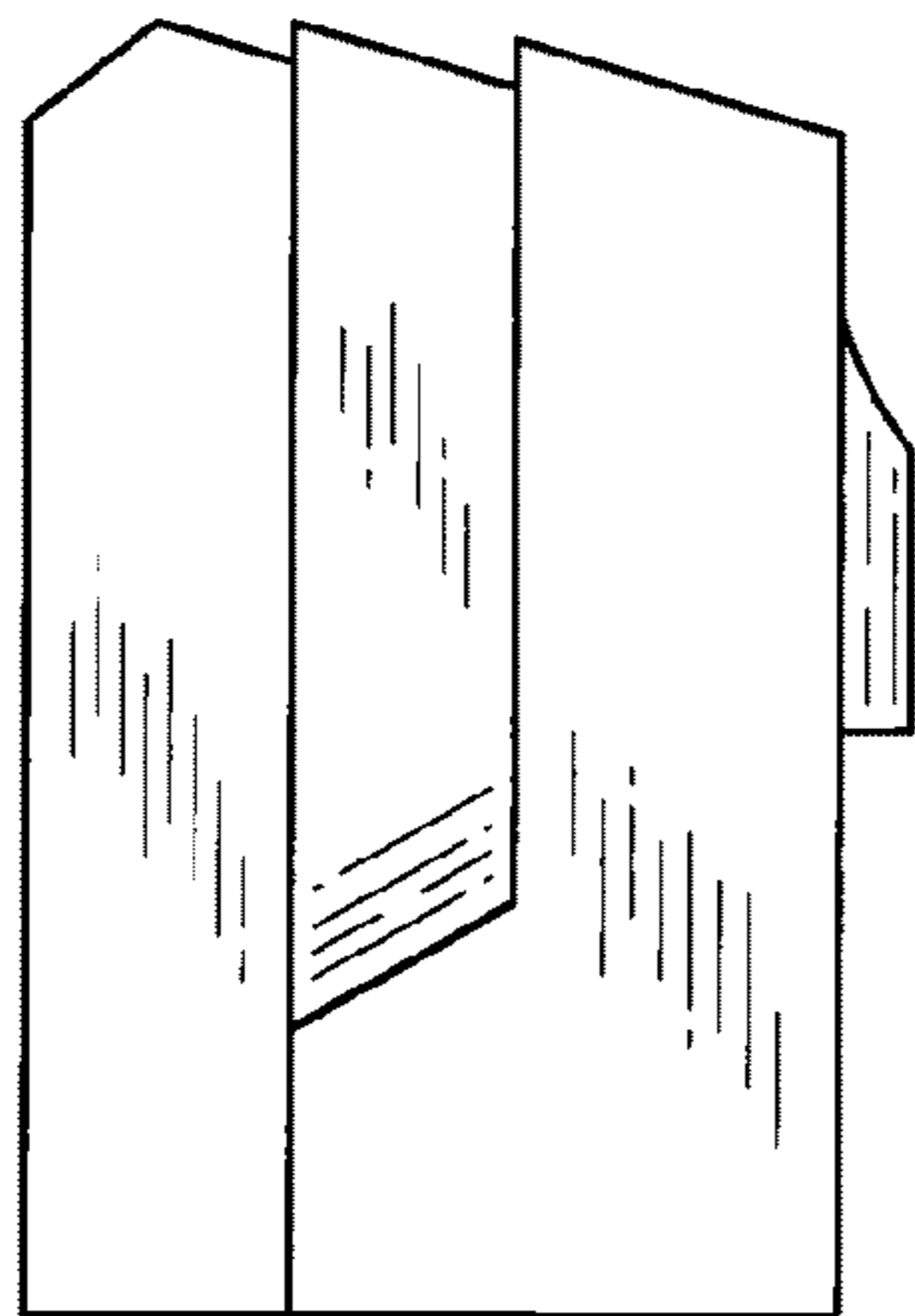

Fig. 8

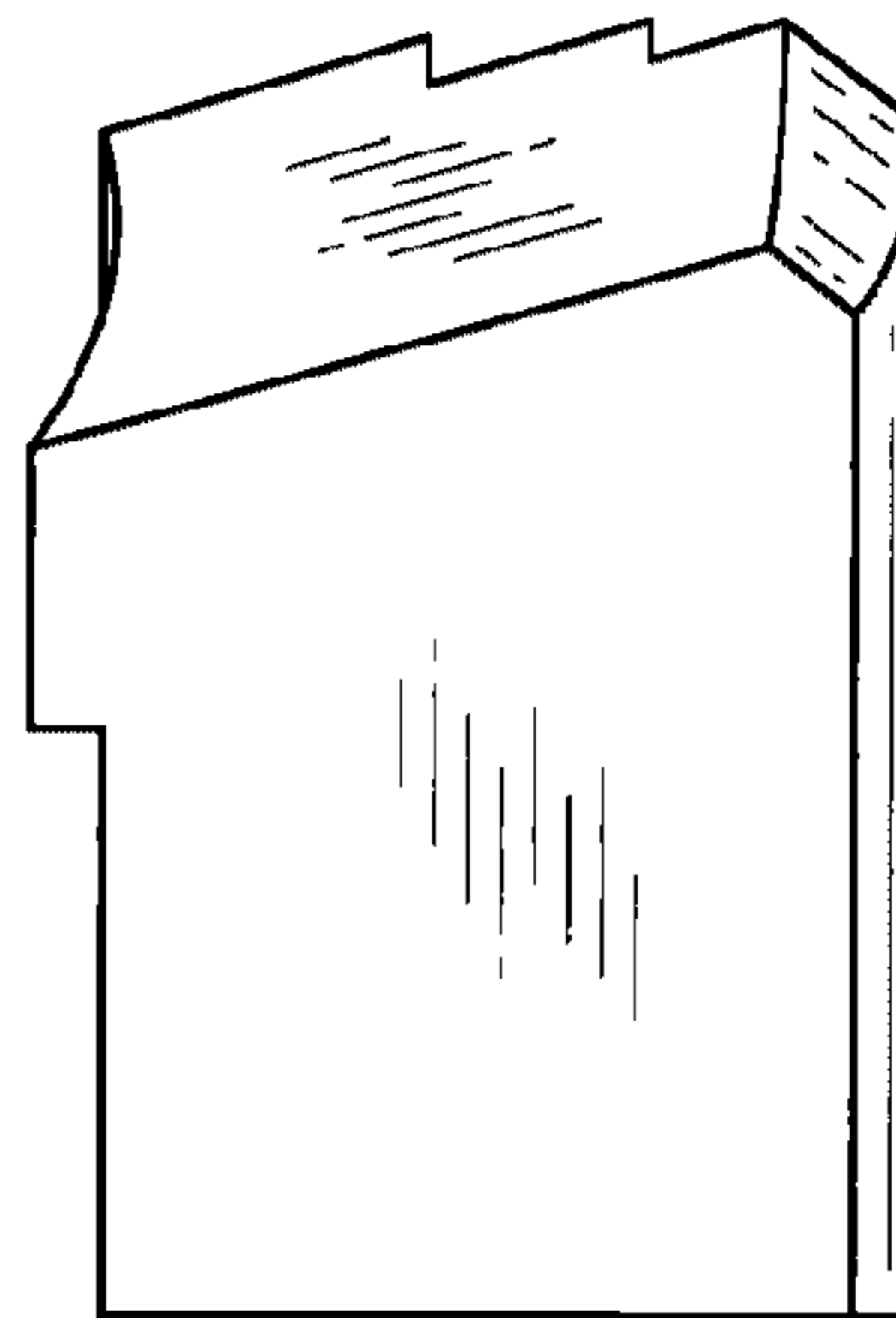

Fig. 9

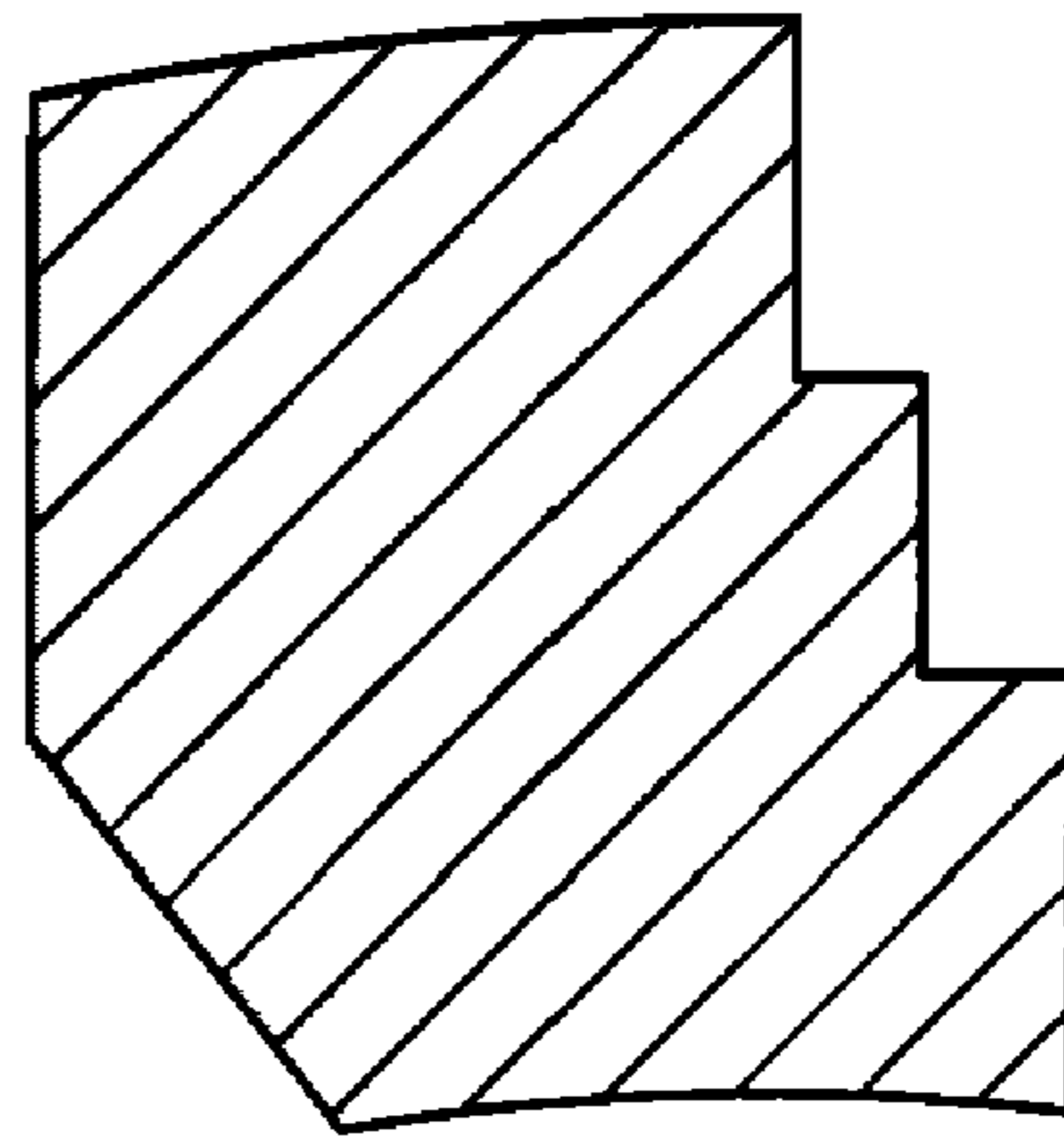

Fig. 10

