



US00D647008S

(12) **United States Design Patent**  
**Takano et al.**

(10) **Patent No.:** **US D647,008 S**  
(45) **Date of Patent:** **\*\* Oct. 18, 2011**

(54) **VEHICULAR TRACTION HOOK AND FORMS**

(75) Inventors: **Takeji Takano**, Kawasaki (JP);  
**Tsutomu Uchida**, Kawasaki (JP)

(73) Assignee: **Faltec Co., Ltd.**, Kanagawa (JP)

(\*\*) Term: **14 Years**

(21) Appl. No.: **29/345,823**

(22) Filed: **Oct. 22, 2009**

(30) **Foreign Application Priority Data**

Aug. 19, 2009 (JP) ..... 2009-018878

(51) **LOC (9) Cl.** ..... **12-16**

(52) **U.S. Cl.** ..... **D12/162**

(58) **Field of Classification Search** ..... D8/387,  
D8/397; D12/161-162; 411/378, 402-403,  
411/410-411, 911

See application file for complete search history.

(56) **References Cited**

**U.S. PATENT DOCUMENTS**

1,715,975	A *	6/1929	Angell	411/81
2,202,867	A *	6/1940	Rankin	280/508
3,823,962	A *	7/1974	Martin, Jr.	280/514
D234,486	S *	3/1975	Hale	D8/397
D239,504	S *	4/1976	Hale	D8/397
D243,154	S *	1/1977	Dieme	D8/387
4,044,647	A *	8/1977	Takahashi	411/39
4,411,570	A *	10/1983	Juric	411/271
4,616,535	A *	10/1986	Chiavon	81/121.1
D374,814	S *	10/1996	Saito	D8/387
D397,030	S *	8/1998	Lawson	D8/387
D397,607	S *	9/1998	Lawson	D8/397
D412,435	S *	8/1999	Cultice, Jr.	D8/397
D415,016	S *	10/1999	Murguia	D8/387
D423,341	S *	4/2000	Swanstrom	D8/387
6,382,654	B1 *	5/2002	Mahncke	280/491.1
D478,806	S *	8/2003	McDonough et al.	D8/387
D496,260	S *	9/2004	Echazabal	D8/387

6,971,662	B2 *	12/2005	Frischkorn et al.	280/491.5
D576,027	S *	9/2008	Lanz	D8/387
D592,043	S *	5/2009	Suehiro et al.	D8/387
D615,855	S *	5/2010	Gaudron et al.	D8/387
2006/0024146	A1 *	2/2006	Fink et al.	411/103
2010/0003103	A1 *	1/2010	Takano	411/103

**FOREIGN PATENT DOCUMENTS**

JP	4-39911	4/1992
JP	2003-002136	1/2003
WO	WO-2008/129860	4/2008

\* cited by examiner

*Primary Examiner* — T. Chase Nelson

*Assistant Examiner* — Kathleen M Sims

(74) *Attorney, Agent, or Firm* — Jordan and Hamburg LLP

(57) **CLAIM**

The ornamental design for a vehicular traction hook and forms, as shown and described.

**DESCRIPTION**

FIG. 1 is a right side elevational view of a vehicular traction hook and forms showing our new design;  
 FIG. 2 is a left side elevational view thereof;  
 FIG. 3 is a top plan view thereof;  
 FIG. 4 is a bottom plan view thereof;  
 FIG. 5 is a front elevational view thereof;  
 FIG. 6 is a rear elevational view thereof;  
 FIG. 7 is a view of surrounding environmental matter while the design is in use;  
 FIG. 8 is a view of surrounding environmental matter while the design is in use; and,  
 FIG. 9 is an enlarged view thereof shown while in use.  
 The broken line showing of adjacent environmental matter shown throughout FIGS. 1-9 is included for the purpose of showing environmental portions of the vehicular traction hook and forms and a vehicle in use thereof and forms no part of the claimed design.

**1 Claim, 4 Drawing Sheets**

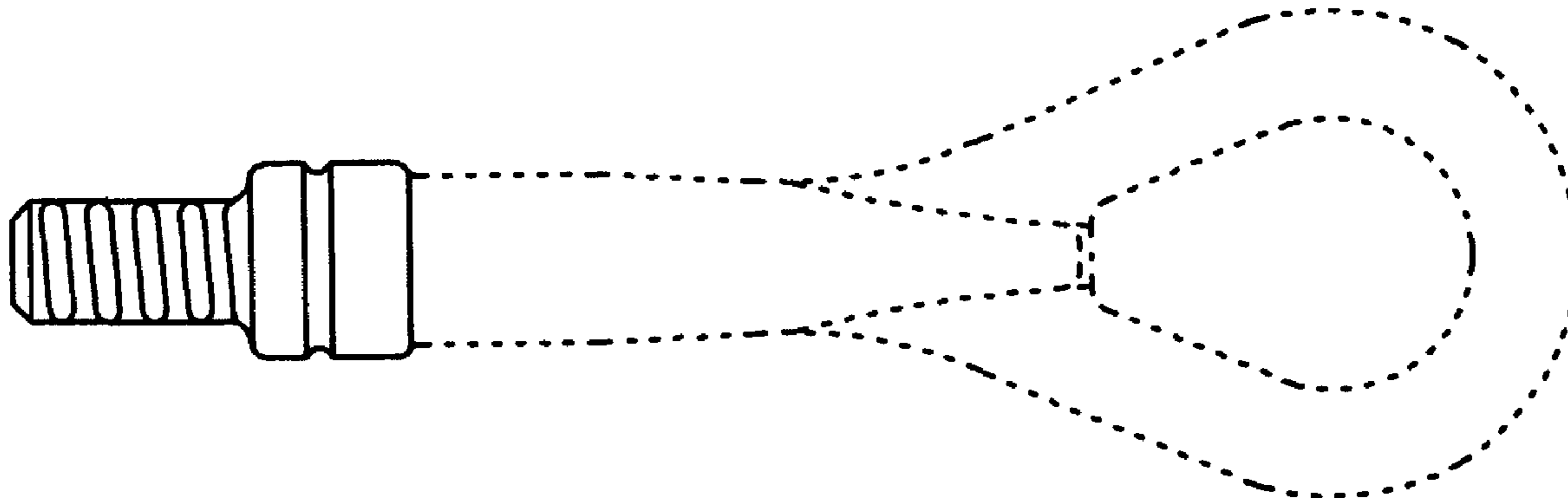

Fig. 1

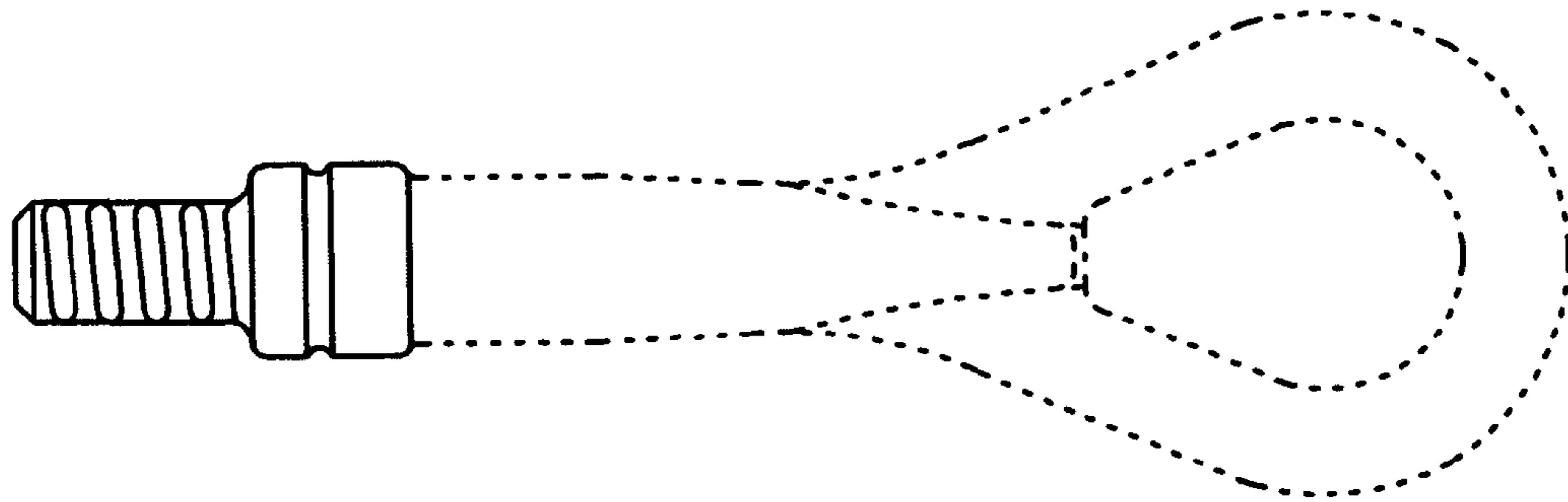

Fig. 2

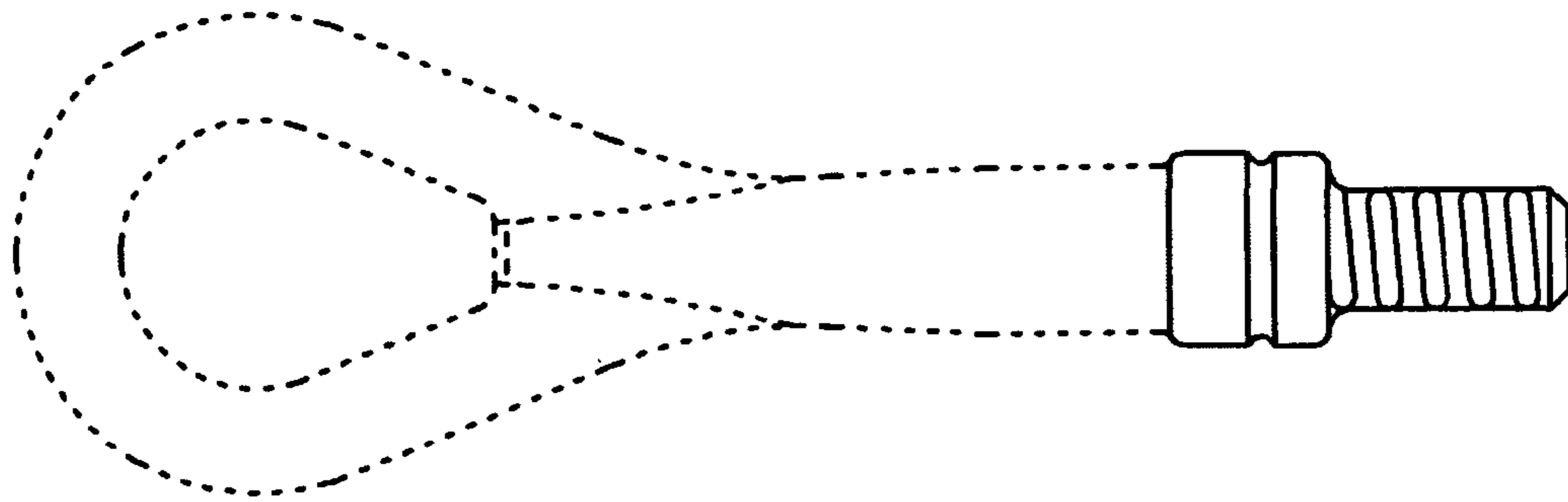

Fig. 3

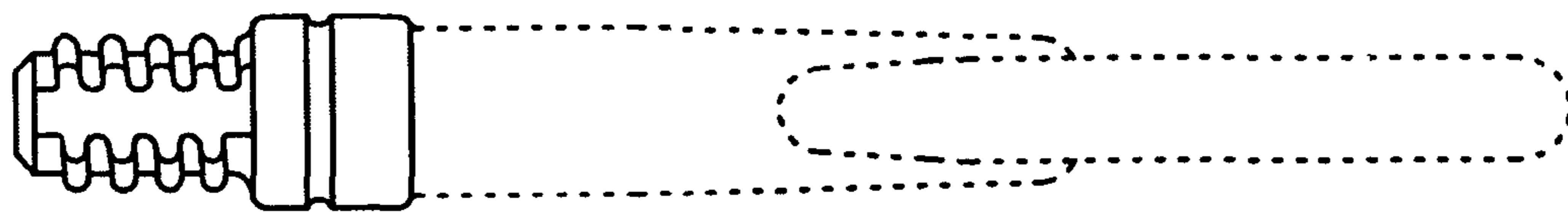

Fig. 4

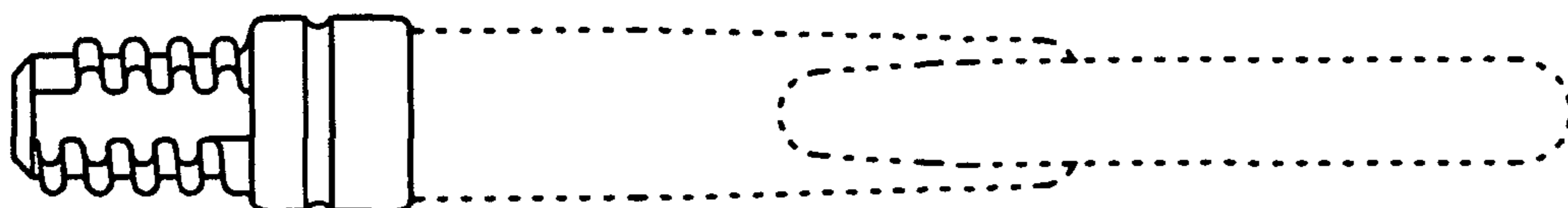

Fig. 5

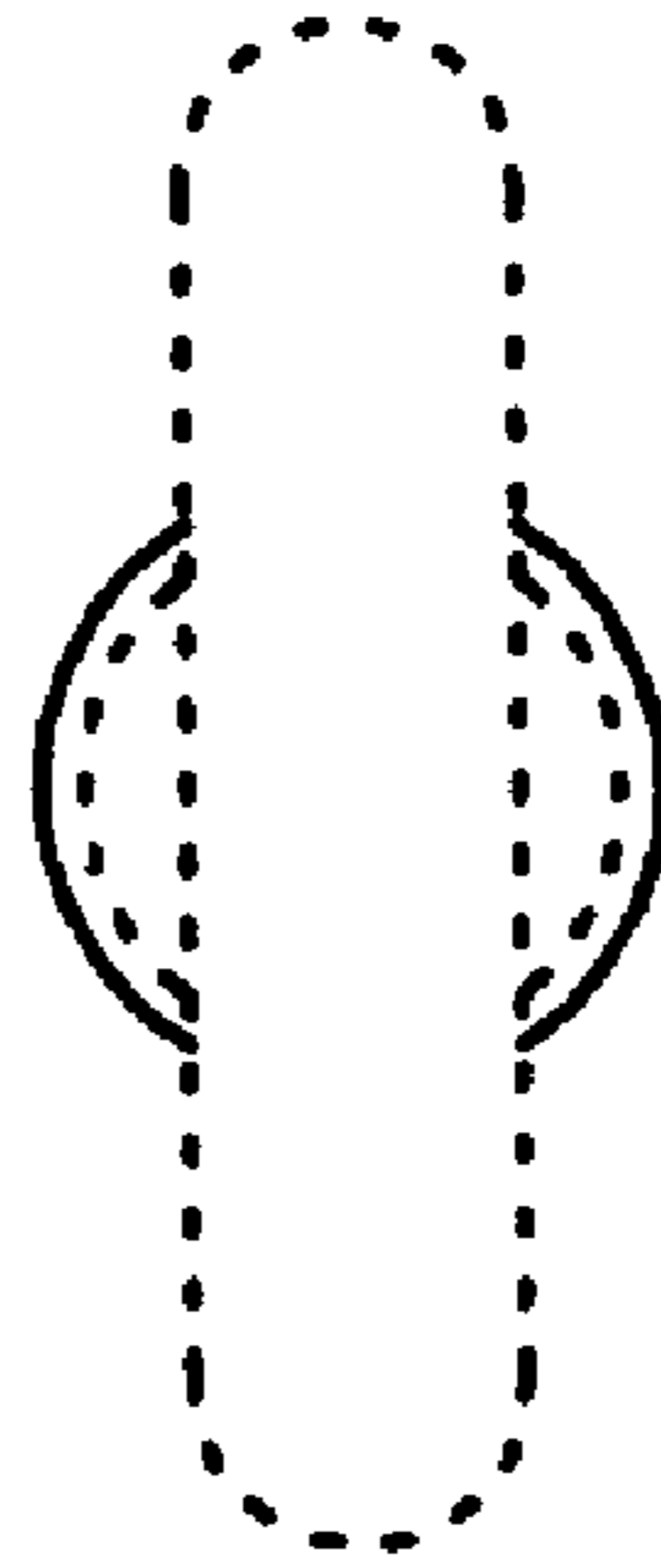

Fig. 6

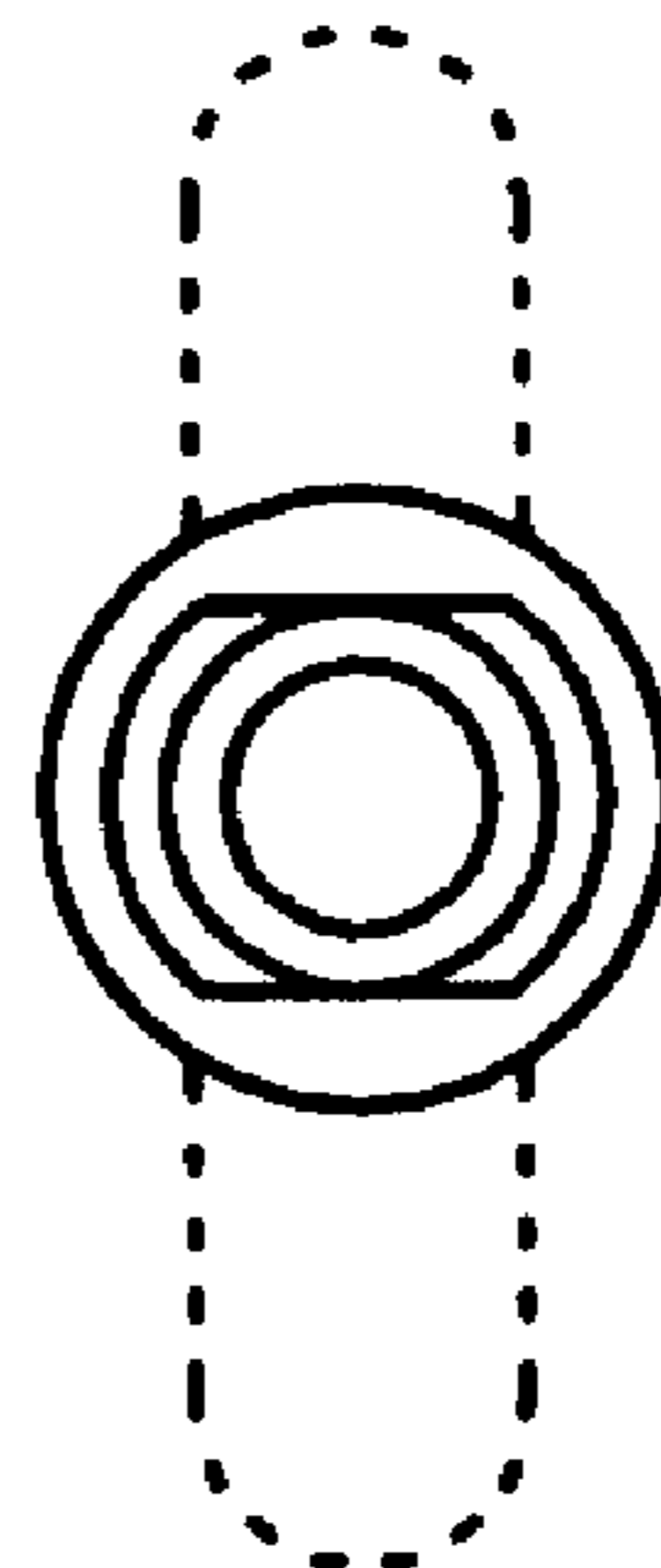

Fig. 7

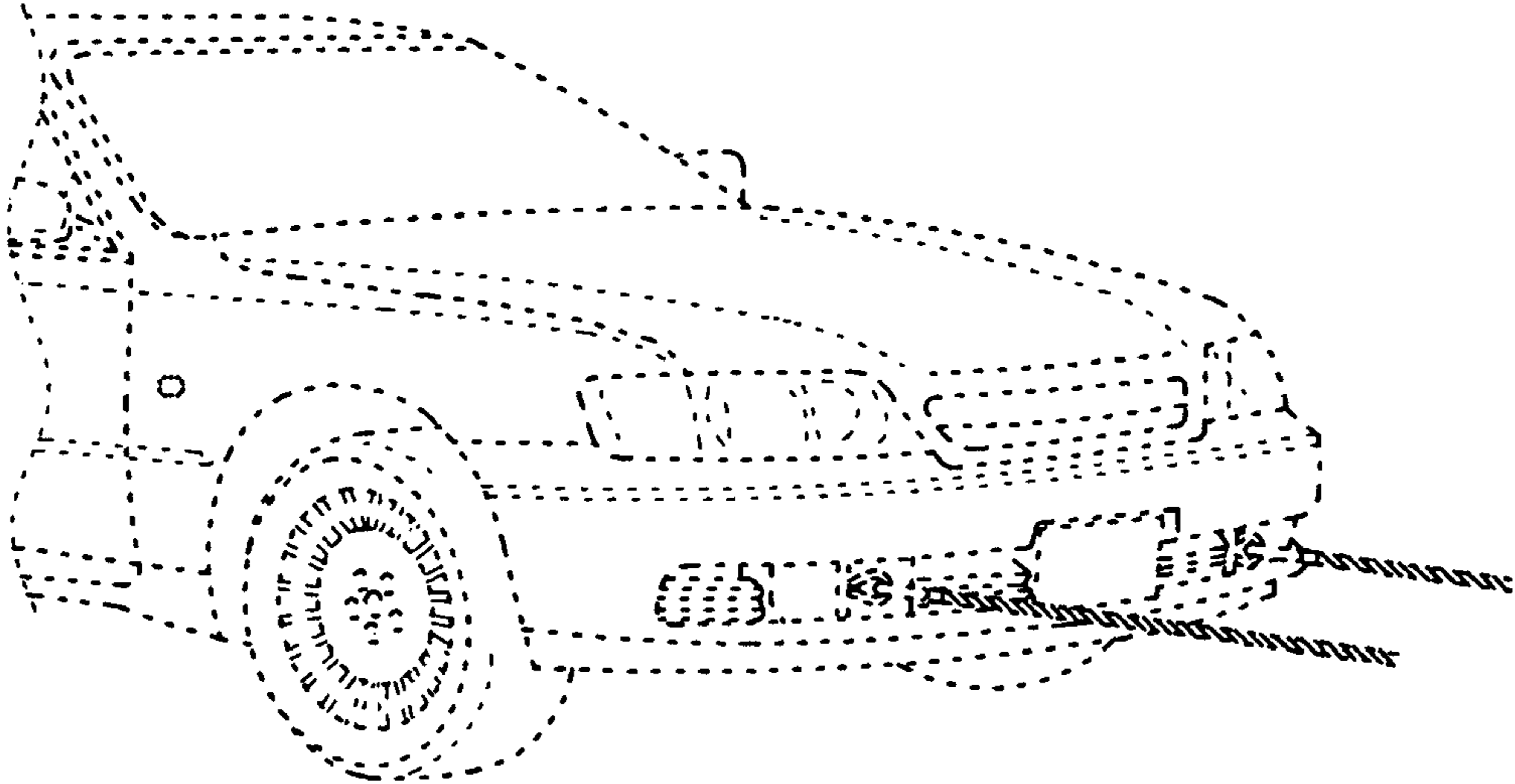

Fig. 8

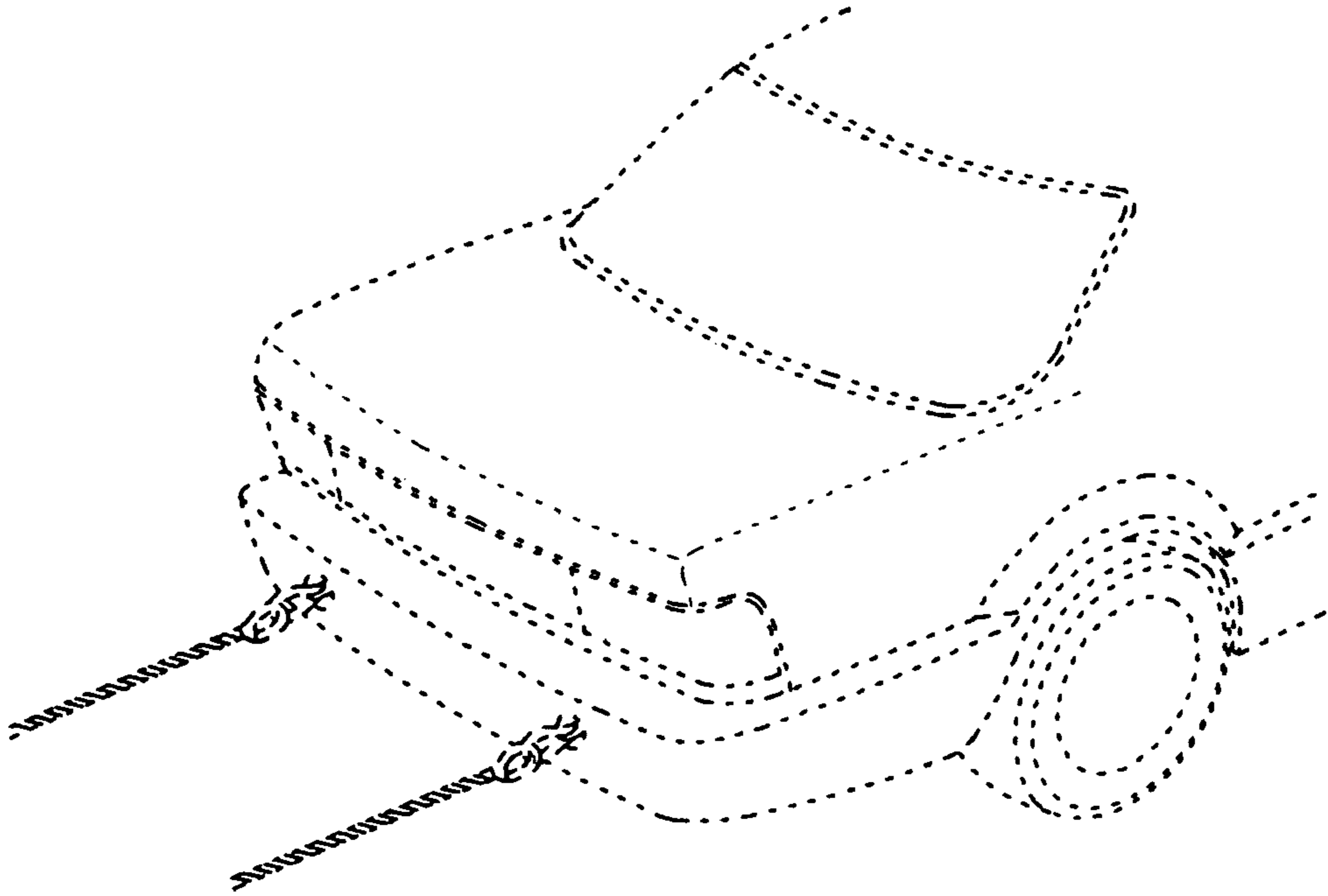

Fig. 9

