



US00D647006S

(12) **United States Design Patent**
Hung

(10) **Patent No.:** **US D647,006 S**

(45) **Date of Patent:** **** Oct. 18, 2011**

(54) **SCOOTER**

(75) **Inventor:** **Mu-Chen Hung**, Kaohsiung Hsien (TW)

(73) **Assignee:** **Taiwan Golden Bee Co., Ltd.**,
Kaohsiung Hsien (TW)

(**) **Term:** **14 Years**

(21) **Appl. No.:** **29/366,228**

(22) **Filed:** **Jul. 21, 2010**

(51) **LOC (9) Cl.** **12-11**

(52) **U.S. Cl.** **D12/110**

(58) **Field of Classification Search** D12/110;
180/219, 220

See application file for complete search history.

(56) **References Cited**

U.S. PATENT DOCUMENTS

D270,436 S * 9/1983 Gaddi D12/110
D287,834 S * 1/1987 Ito et al. D12/110

D491,492 S * 6/2004 Lu D12/110
D596,992 S * 7/2009 Yang D12/110
D602,813 S * 10/2009 Chao et al. D12/110
D602,815 S * 10/2009 Lin et al. D12/110

* cited by examiner

Primary Examiner — Susan M Lee

Assistant Examiner — Linda G. Brooks

(74) *Attorney, Agent, or Firm* — Leong C. Lei

(57) **CLAIM**

The ornamental design for a scooter, as shown and described.

DESCRIPTION

FIG. 1 is a perspective view of a scooter showing my new design;

FIG. 2 is a front elevational view thereof;

FIG. 3 is a rear elevational view thereof;

FIG. 4 is a left side elevational view thereof;

FIG. 5 is a right side elevational view thereof; and,

FIG. 6 is a top plan view thereof.

1 Claim, 6 Drawing Sheets

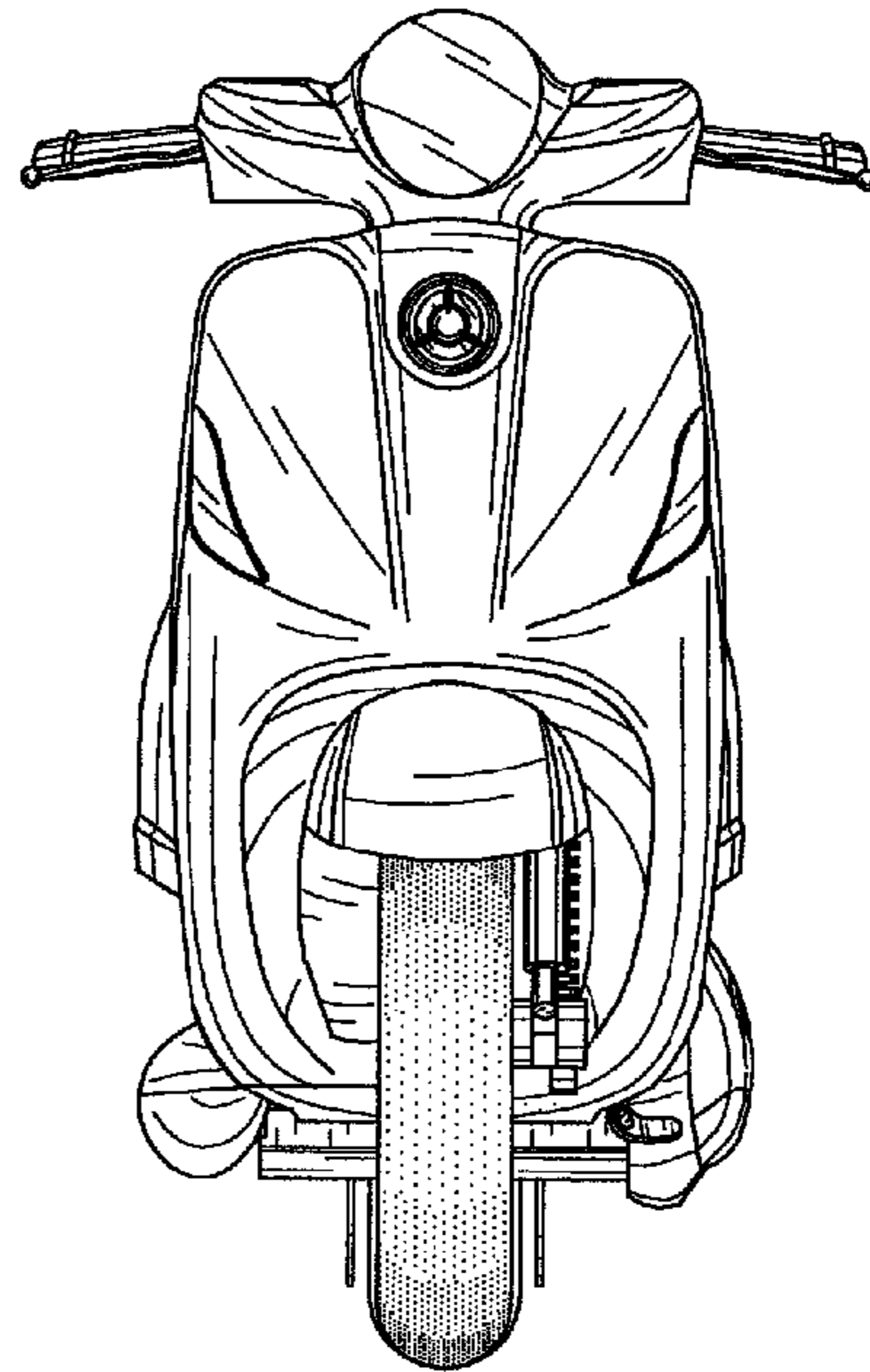
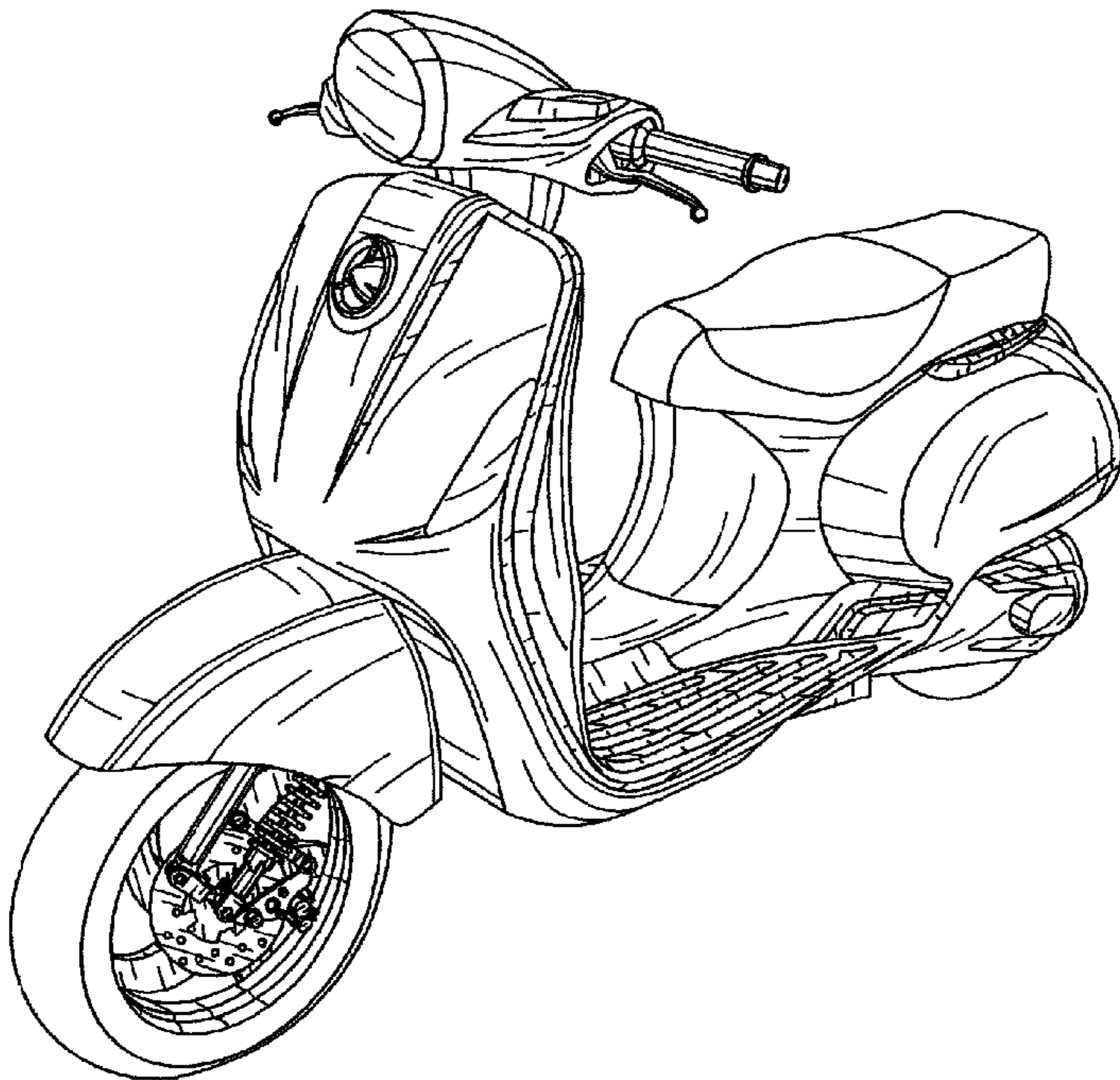

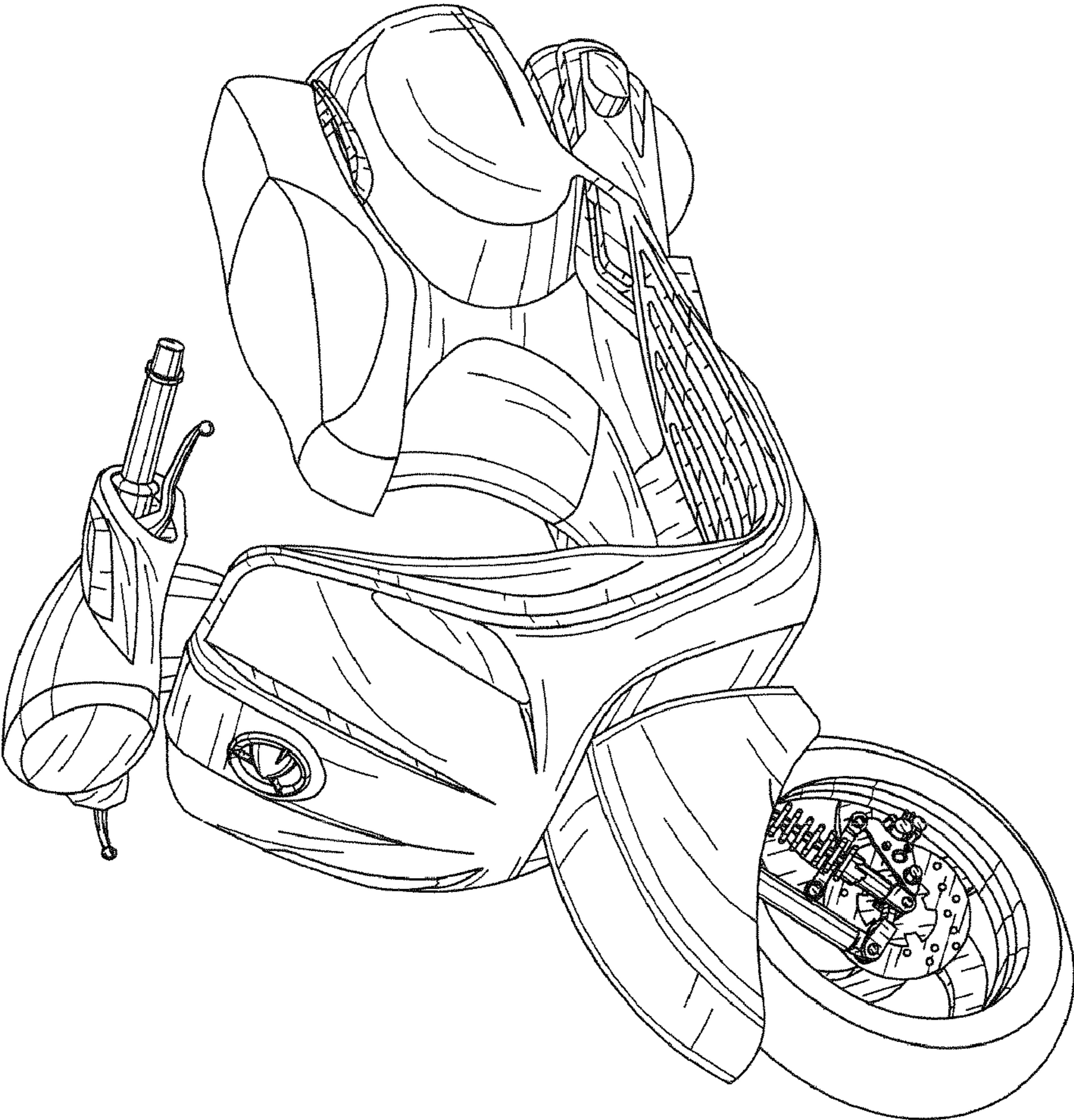

FIG. 1

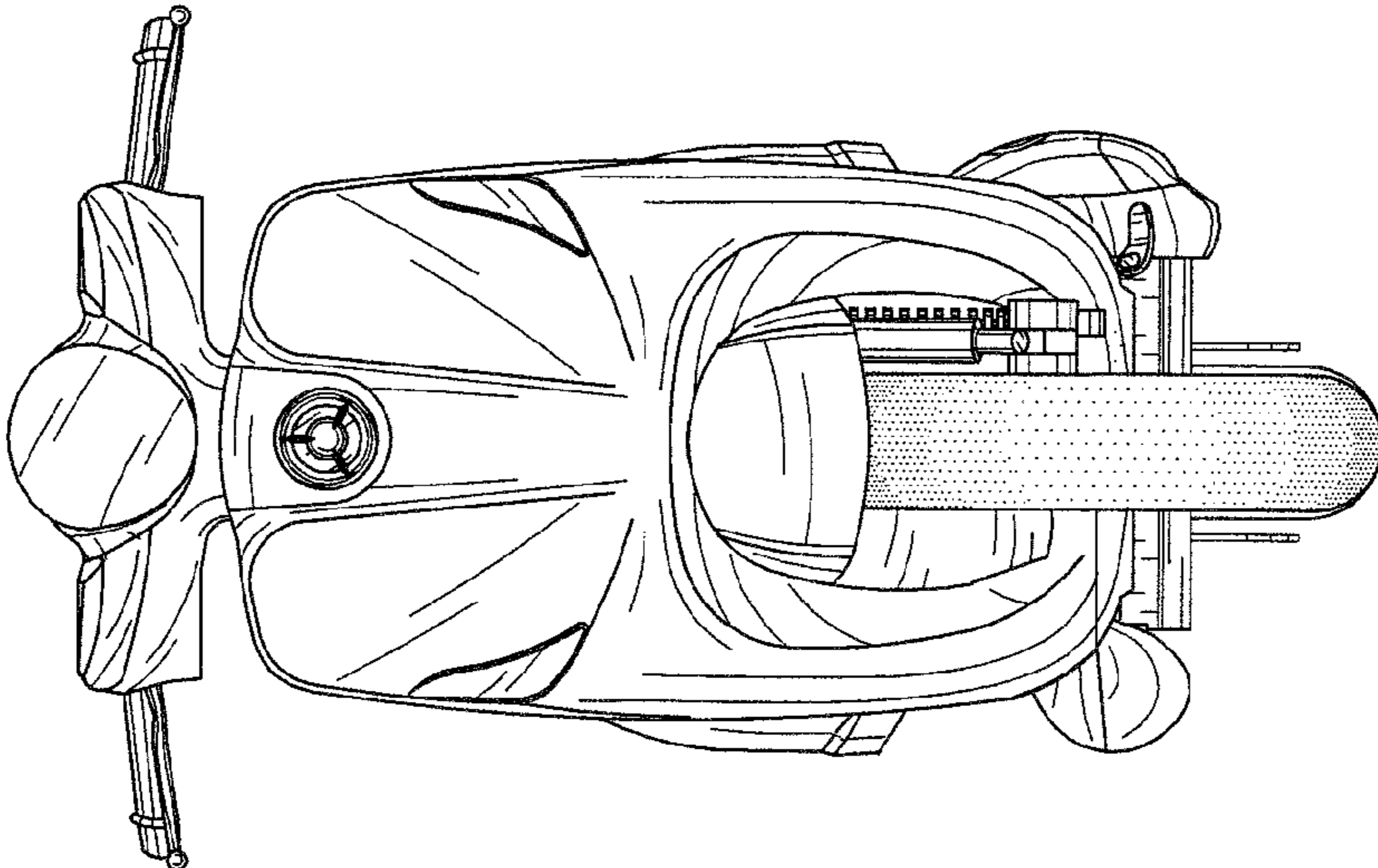

FIG. 2

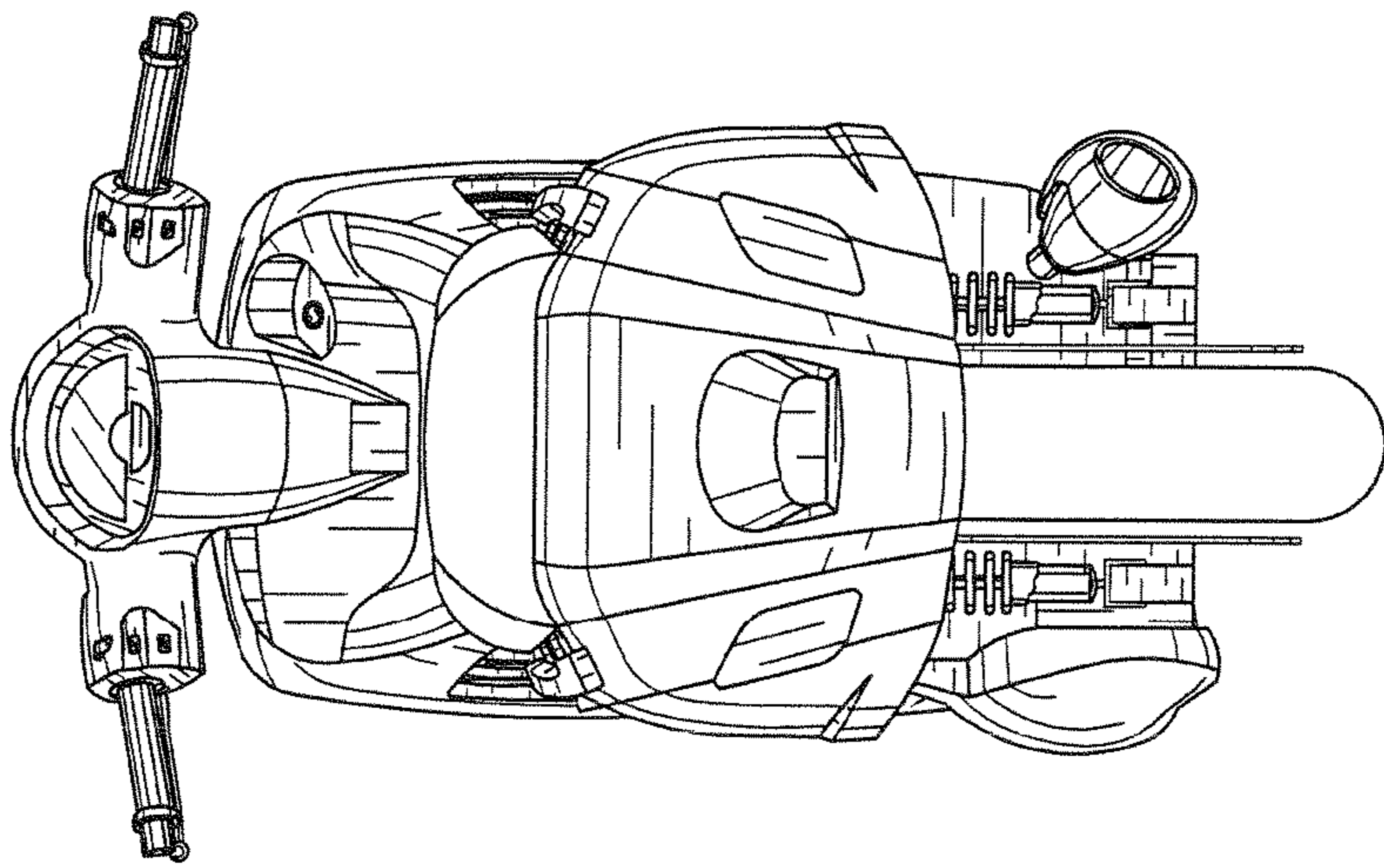

FIG.3

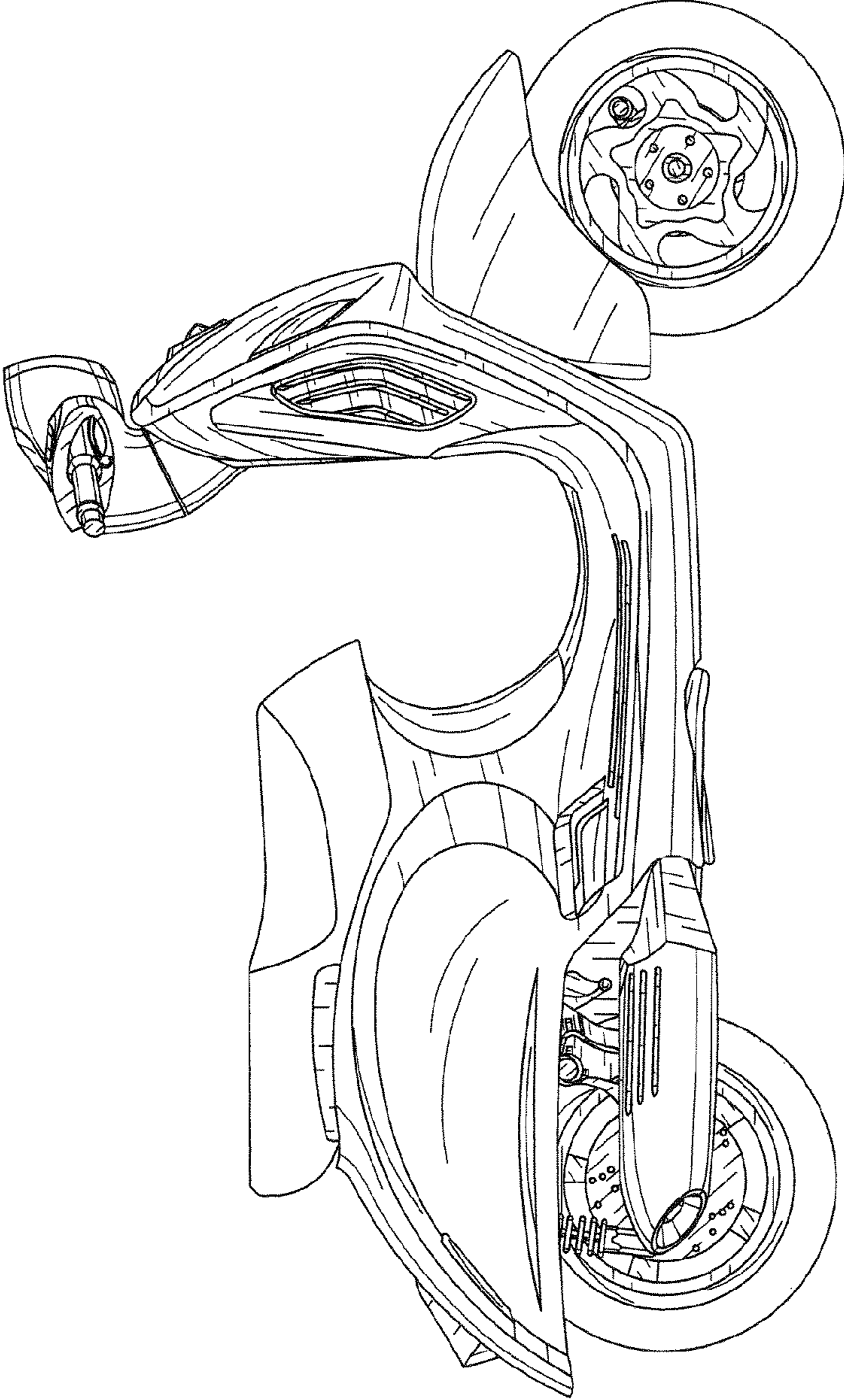

FIG.4

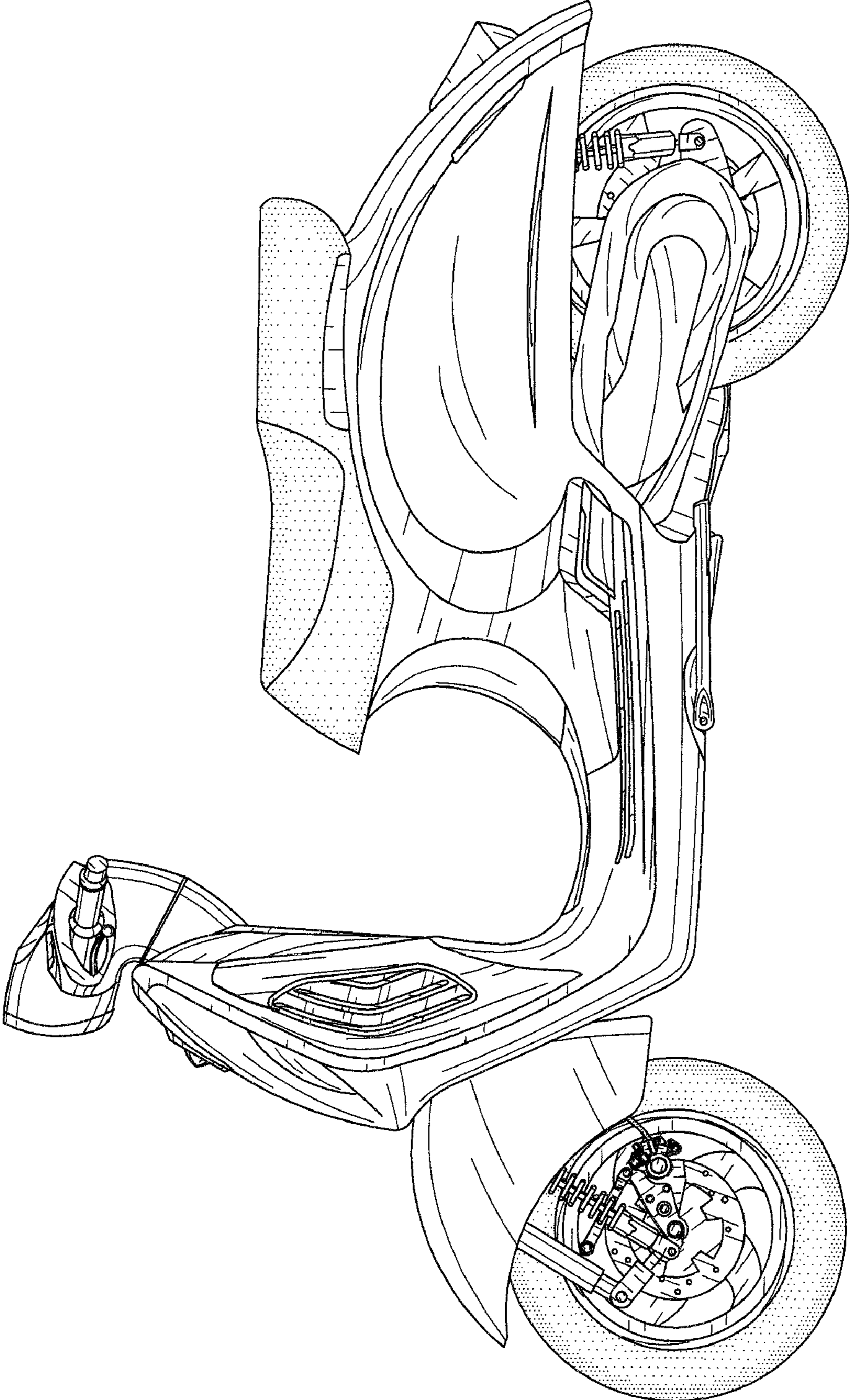

FIG. 5

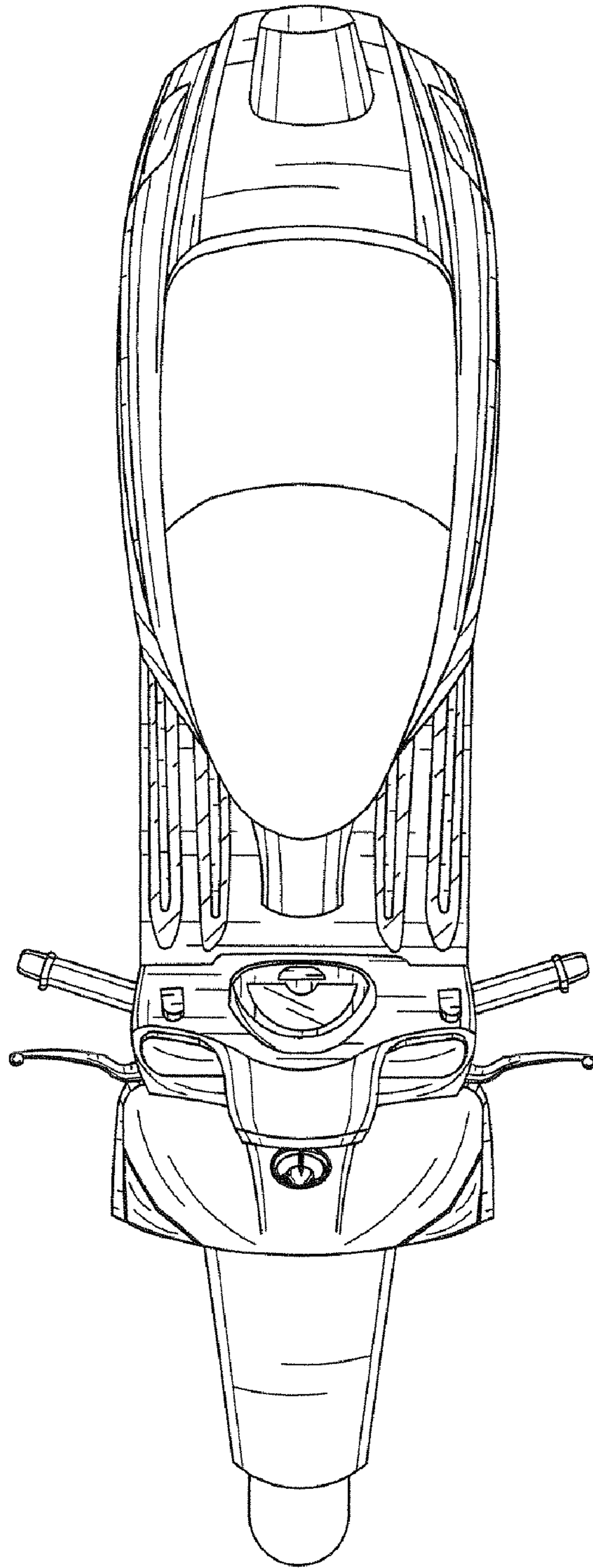

FIG.6