



US00D646996S

(12) **United States Design Patent**
Kawaguchi

(10) **Patent No.:** **US D646,996 S**
(45) **Date of Patent:** **** Oct. 18, 2011**

(54) **BUCKLE**

(75) Inventor: **Gaku Kawaguchi**, Yokohama (JP)

(73) Assignee: **NIFCO Inc.**, Yokohama-Shi,
Kanagawa-Ken (JP)

(**) Term: **14 Years**

(21) Appl. No.: **29/371,158**

(22) Filed: **Nov. 2, 2010**

(30) **Foreign Application Priority Data**

May 7, 2010 (JP) 2010-011091

(51) **LOC (9) Cl.** **02-07**

(52) **U.S. Cl.** **D11/216**

(58) **Field of Classification Search** D11/1-2,
D11/200-201, 206-210, 214-218; 24/163 R,
24/169-171, 173, 177-179, 191, 194-195,
24/197, 200, 614-616, 625; 240/169-171;
D3/318; 280/808

See application file for complete search history.

(56) **References Cited**

U.S. PATENT DOCUMENTS

D493,385 S * 7/2004 Uehara et al. D11/216
D495,971 S * 9/2004 Uehara et al. D11/216
D610,945 S * 3/2010 Pontaoe D11/216
D617,679 S * 6/2010 Wang et al. D11/216
D619,496 S * 7/2010 Paik D11/216

* cited by examiner

Primary Examiner — Ralf Seifert

(74) *Attorney, Agent, or Firm* — Manabu Kanesaka

(57) **CLAIM**

The ornamental design for a buckle, as shown and described.

DESCRIPTION

FIG. 1 is a perspective view of a buckle from the front, plan, and right side showing my new design;

FIG. 2 is a perspective view from the rear, bottom, and left side thereof;

FIG. 3 is a front view thereof;

FIG. 4 is a rear view thereof;

FIG. 5 is a plan view thereof;

FIG. 6 is a bottom view thereof;

FIG. 7 is a right side view thereof, a left side view being symmetrical to the right side view;

FIG. 8 is a reference front view thereof;

FIG. 9 is a cross-sectional view of line 9-9 in FIG. 8 thereof;

FIG. 10 is a perspective view of a male portion from the front, plane, and right side;

FIG. 11 is a perspective view from the rear, bottom, and left side thereof;

FIG. 12 is a front view thereof;

FIG. 13 is a rear view thereof;

FIG. 14 is a plan view thereof;

FIG. 15 is a bottom view thereof;

FIG. 16 is a right side view thereof; a left side view being symmetrical to the right side view;

FIG. 17 is a perspective view of a female portion from the front, plane, and right side;

FIG. 18 is a perspective view from the rear, bottom, and left side thereof;

FIG. 19 is a front view thereof;

FIG. 20 is a rear view thereof;

FIG. 21 is a plan view thereof;

FIG. 22 is a bottom view thereof; and,

FIG. 23 is a right side view thereof, a left side view being symmetrical to the right side view.

1 Claim, 9 Drawing Sheets

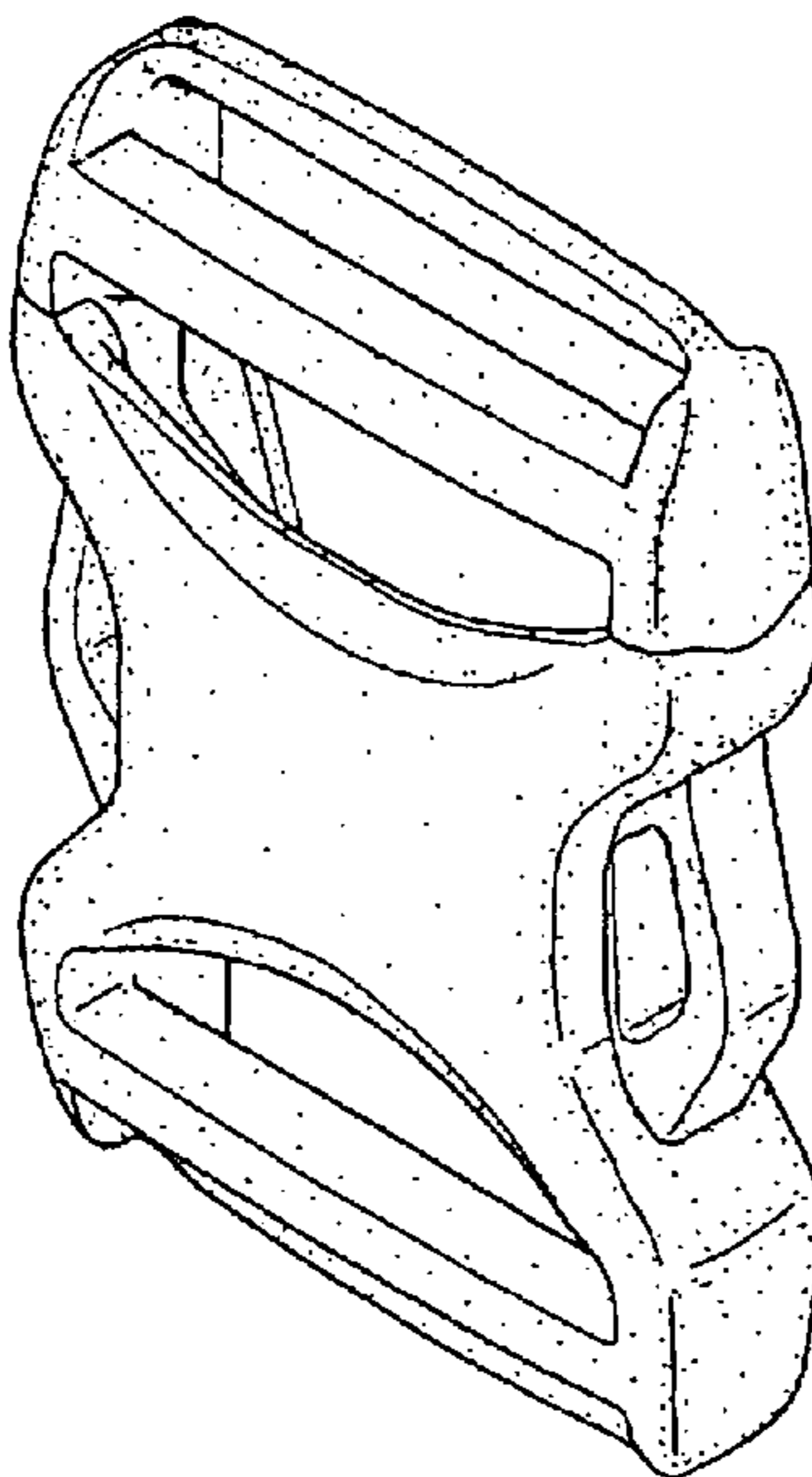

Fig. 1

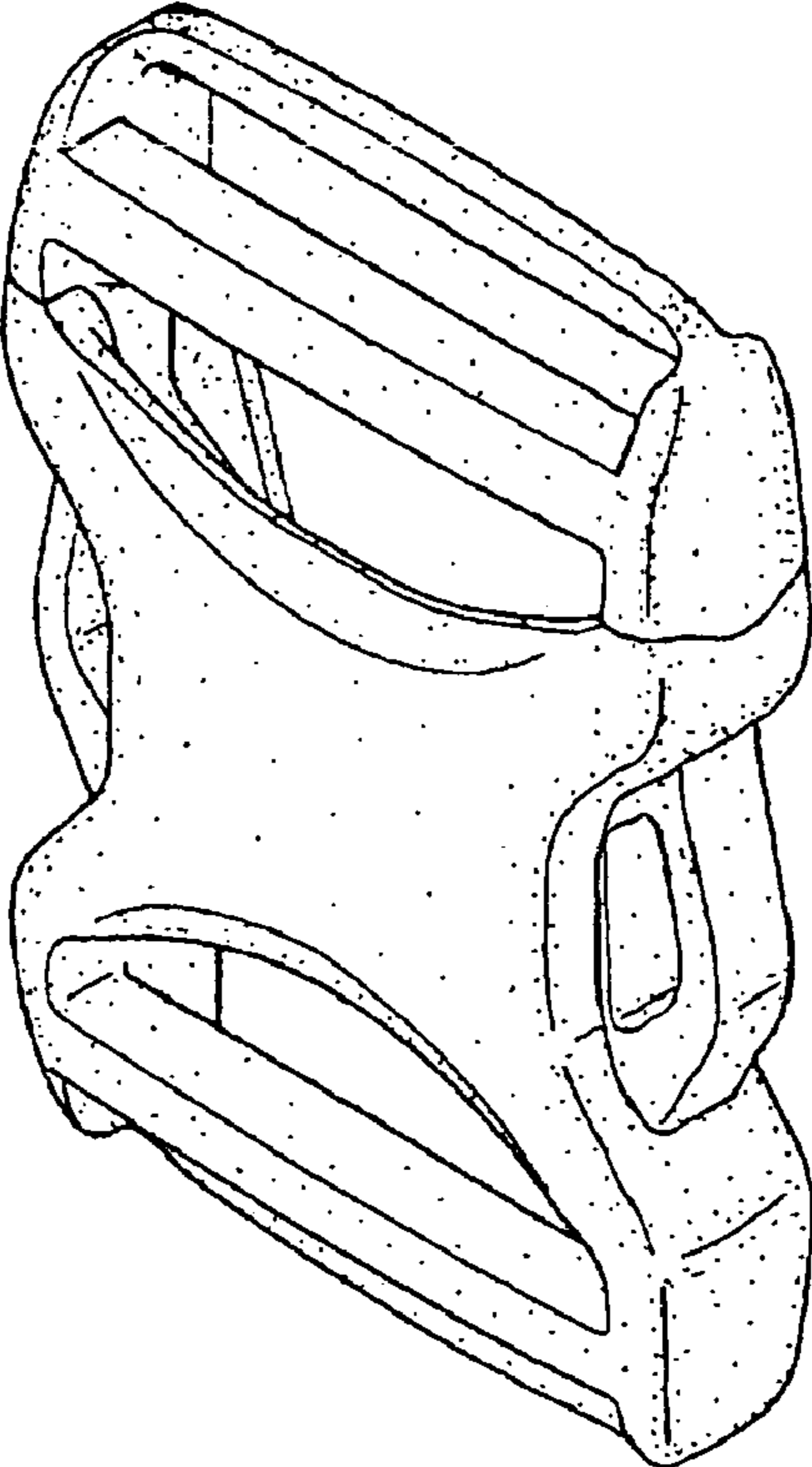

Fig. 2

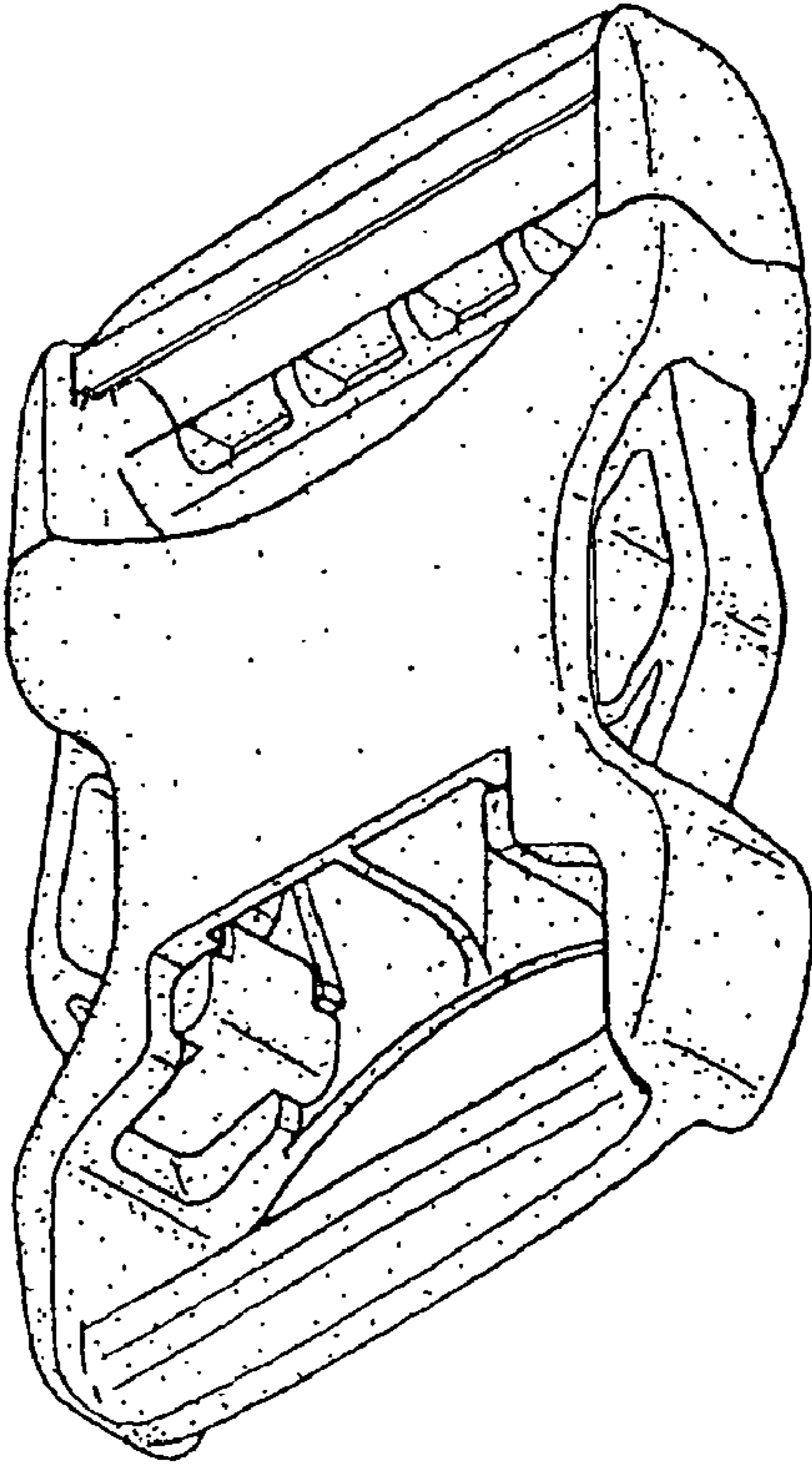

Fig. 3

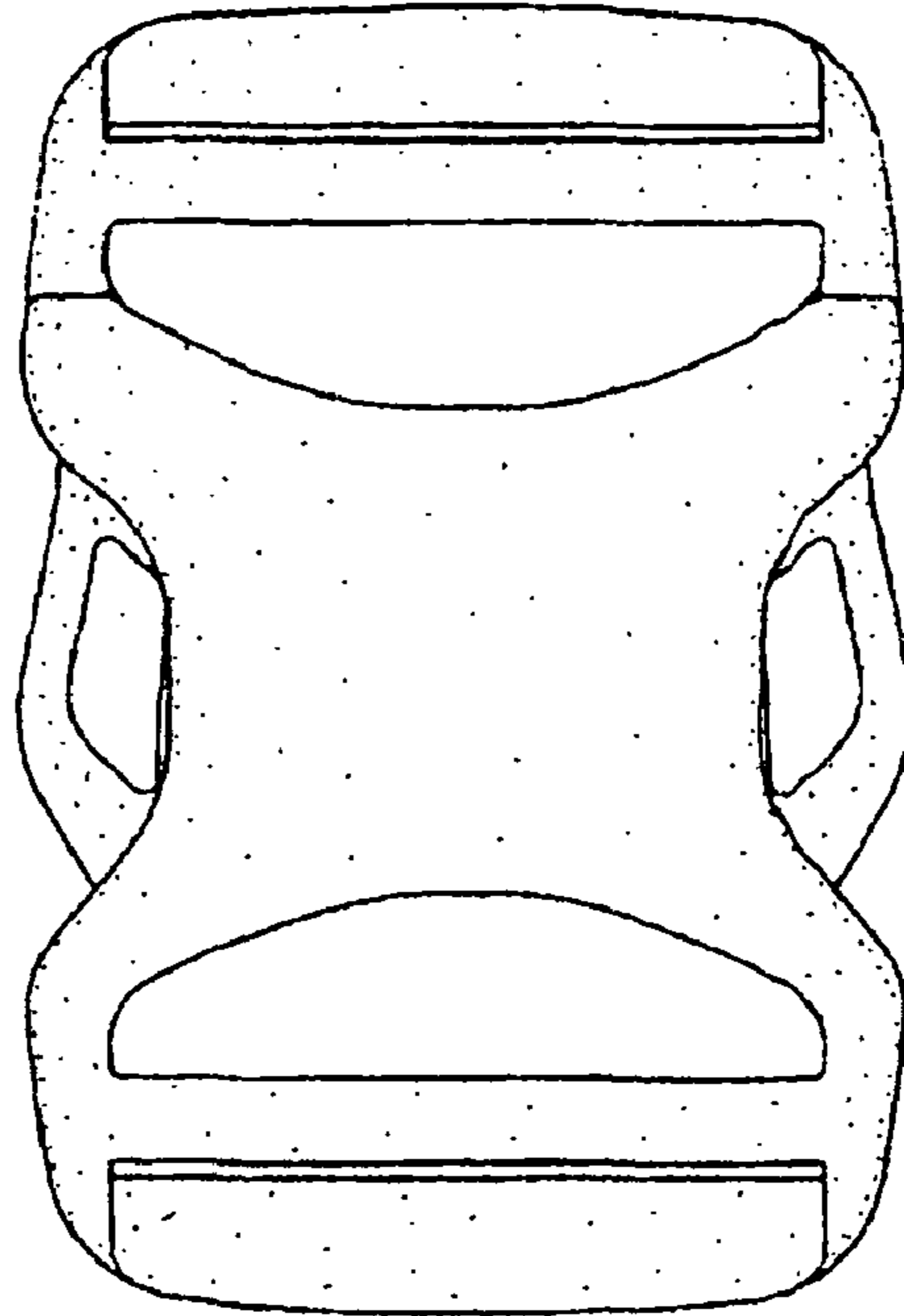

Fig. 4

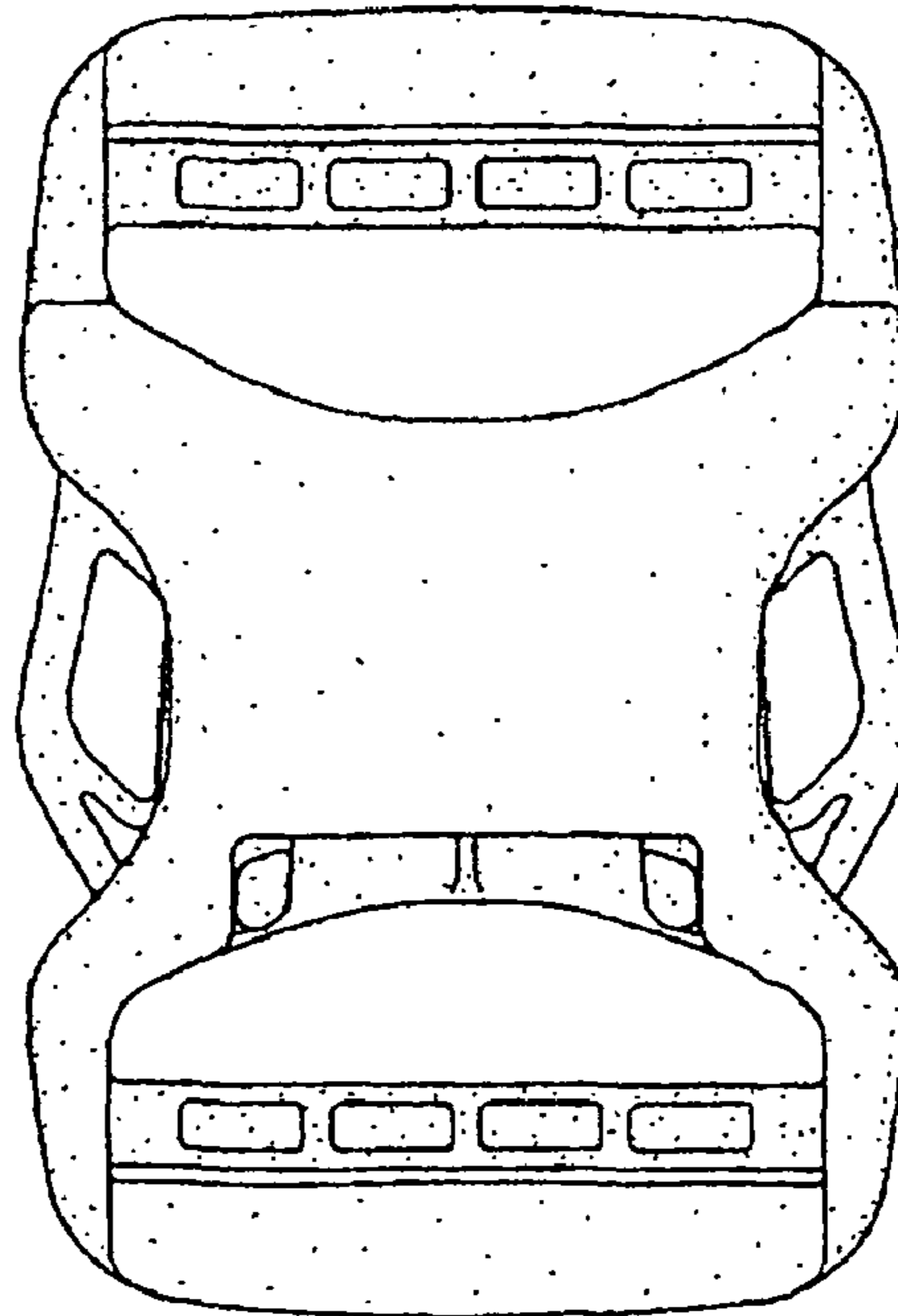

Fig. 5

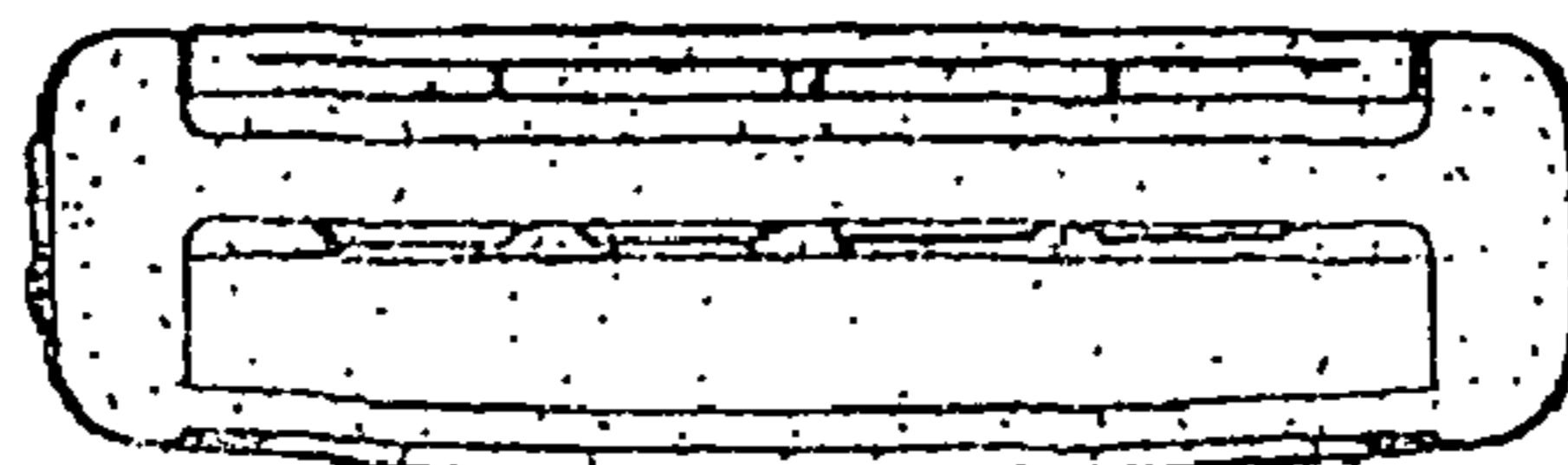

Fig. 6

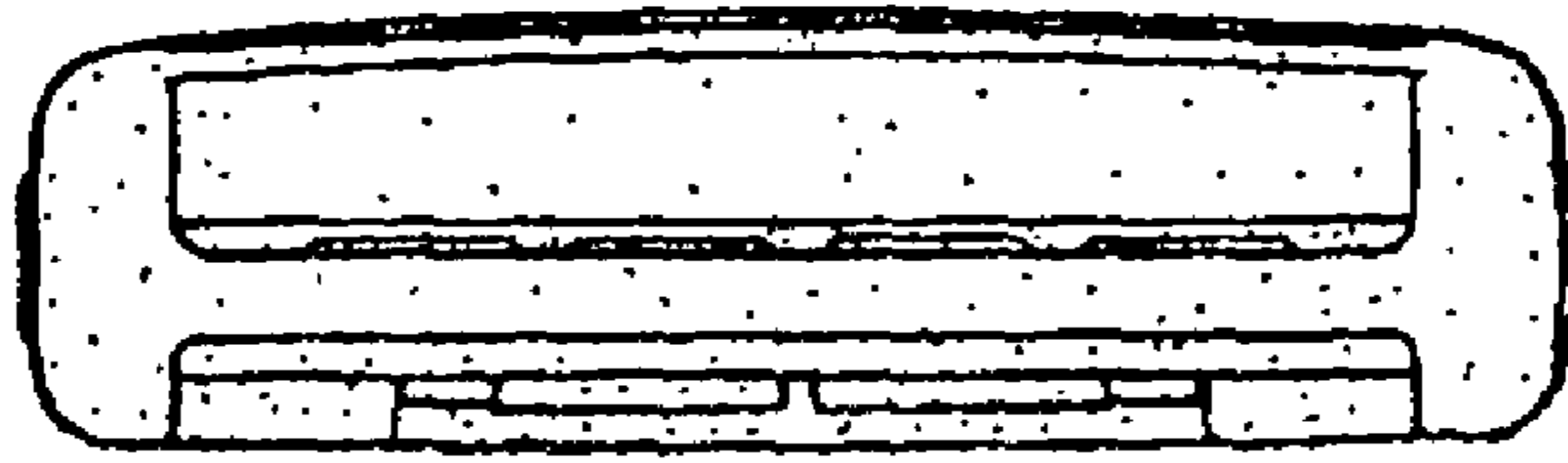

Fig. 7

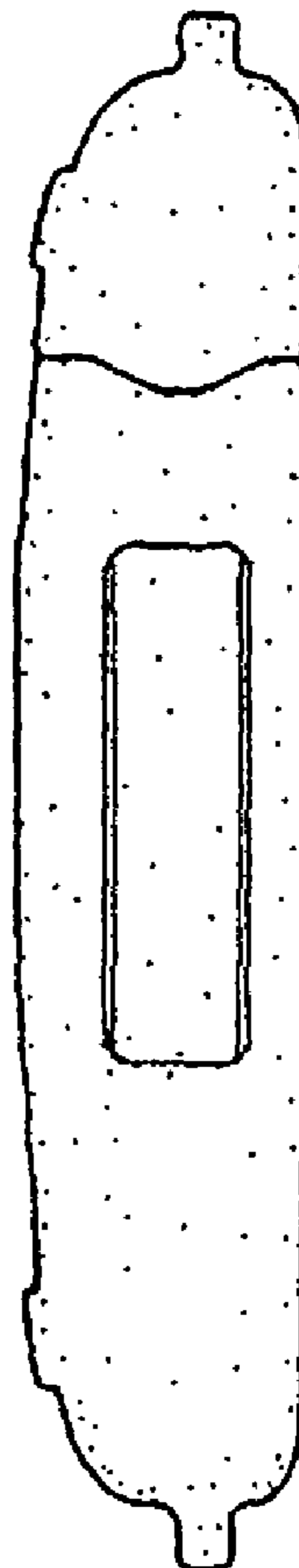

Fig. 8

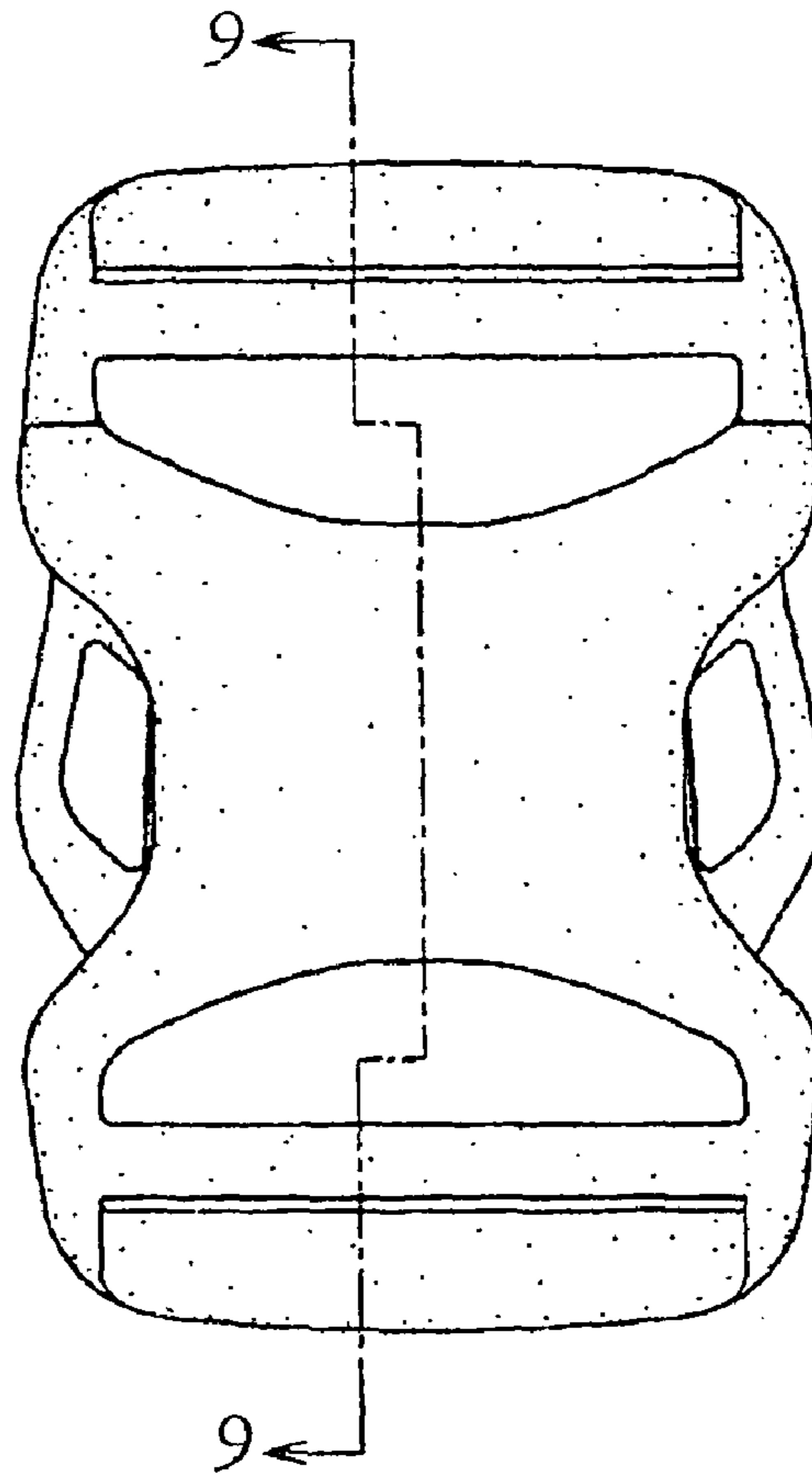

Fig. 9

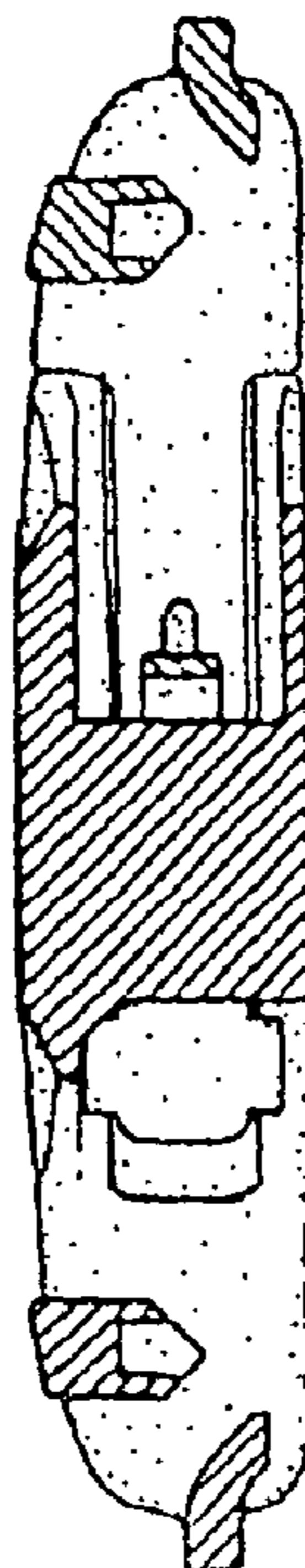

Fig. 10

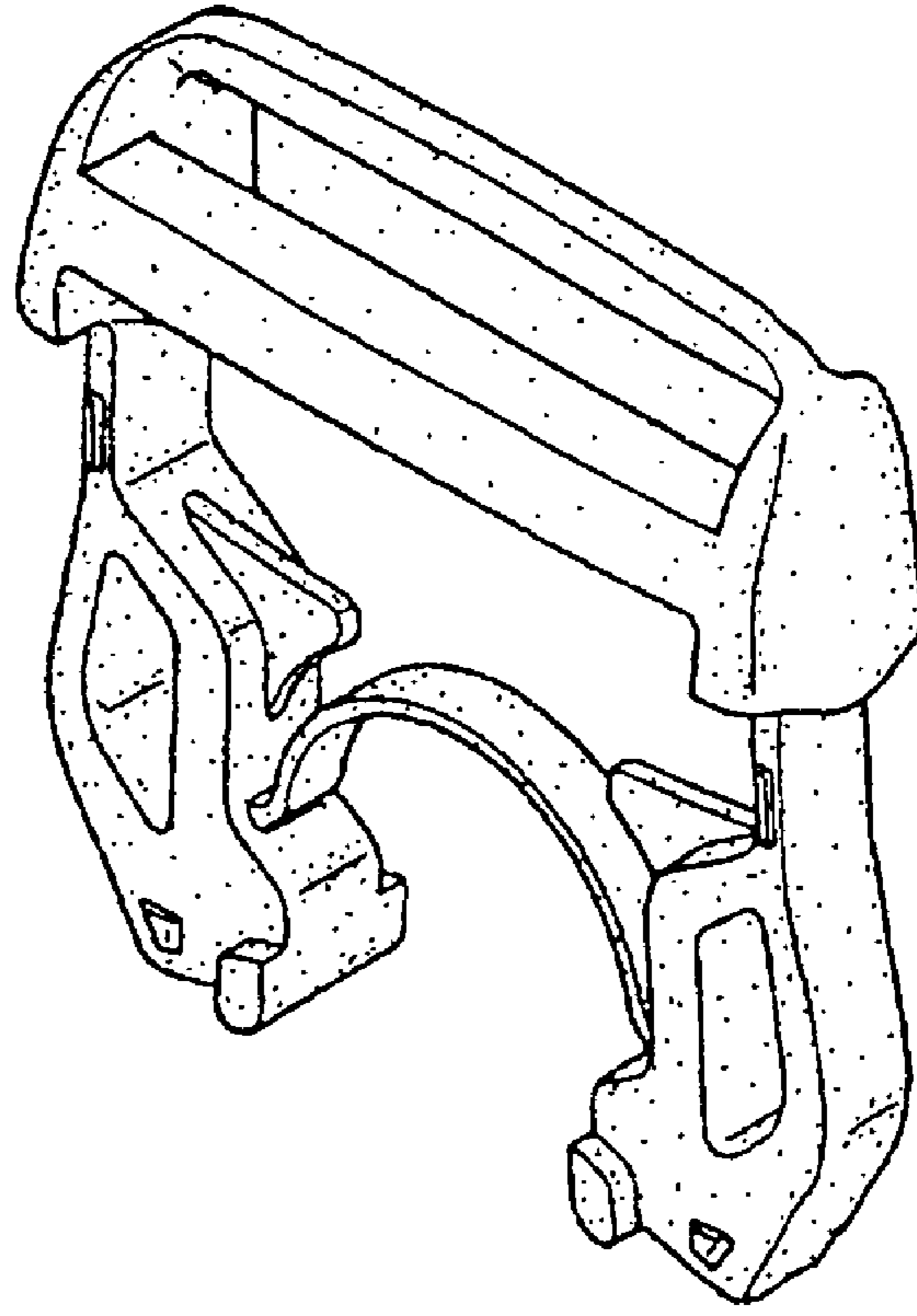

Fig. 11

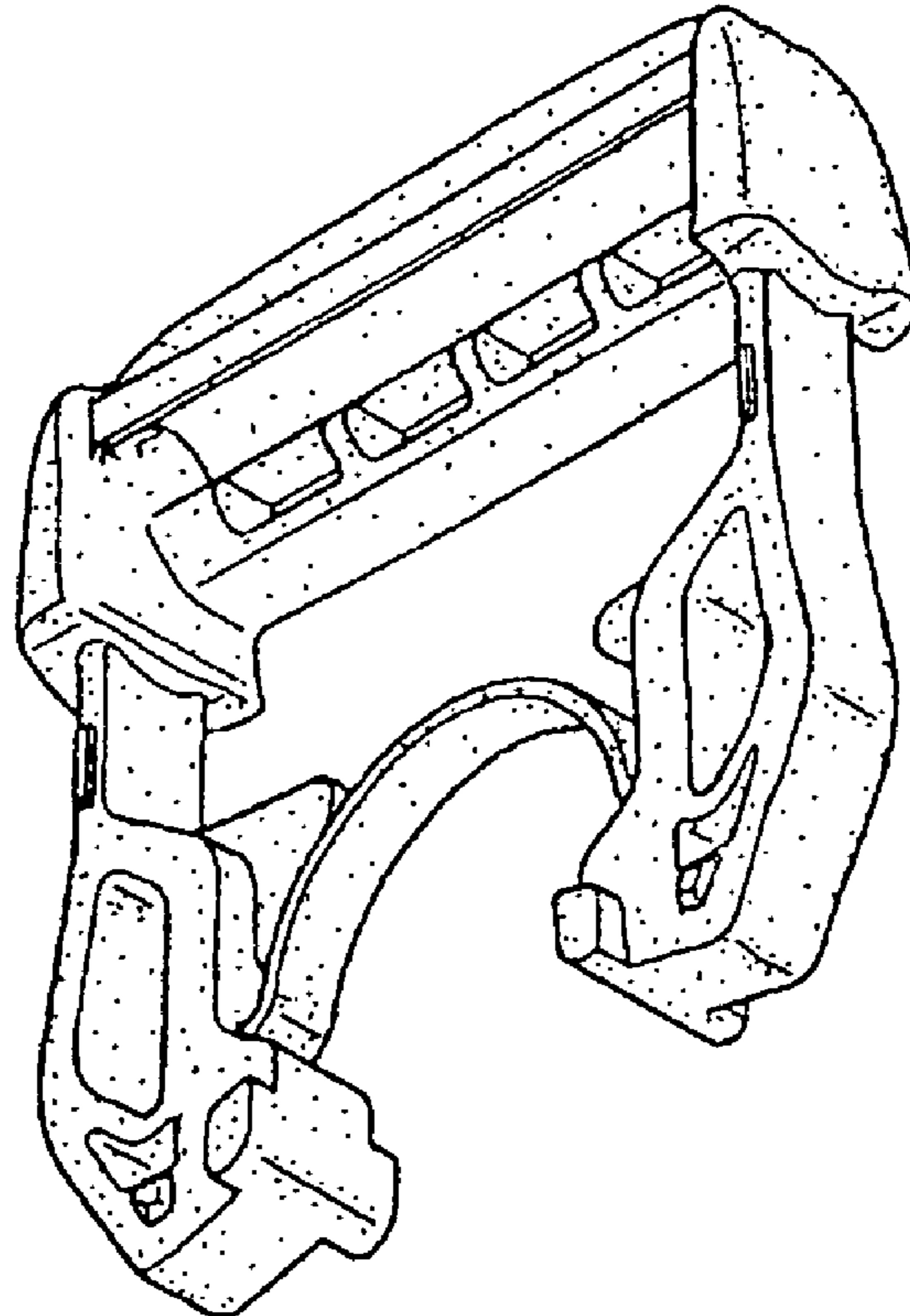

Fig. 12

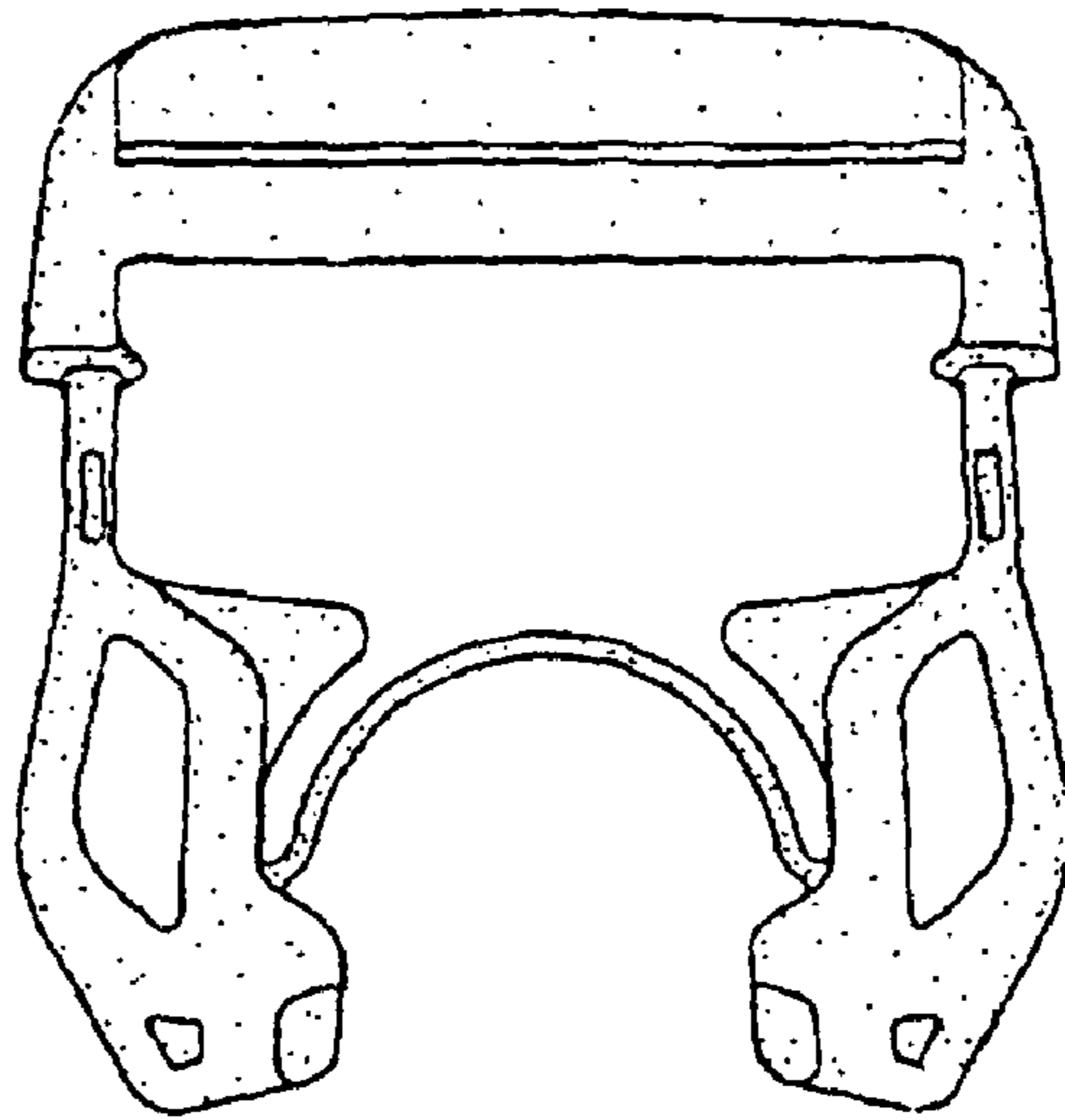

Fig. 13

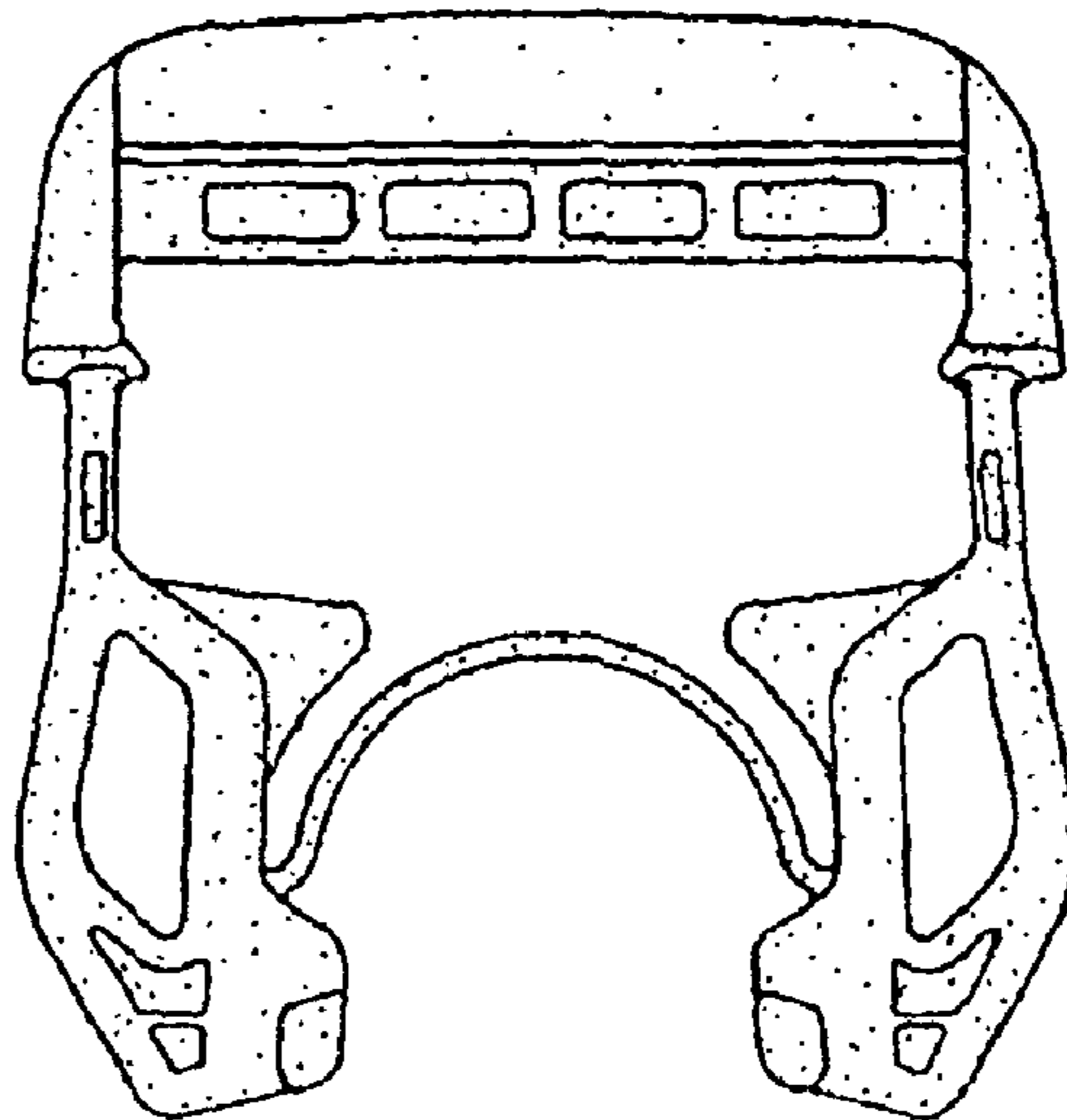

Fig. 14

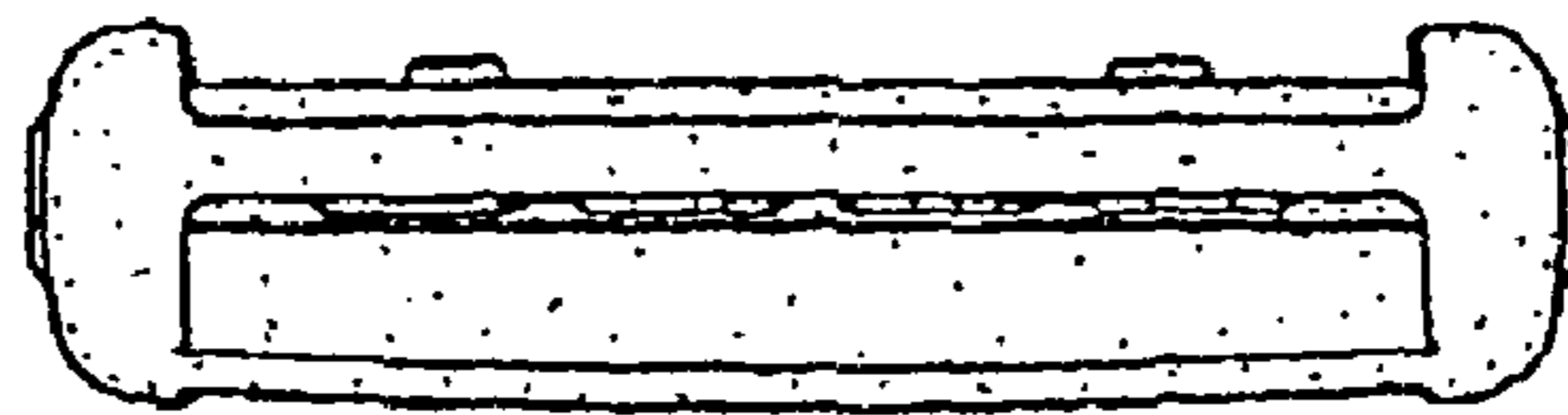

Fig. 15

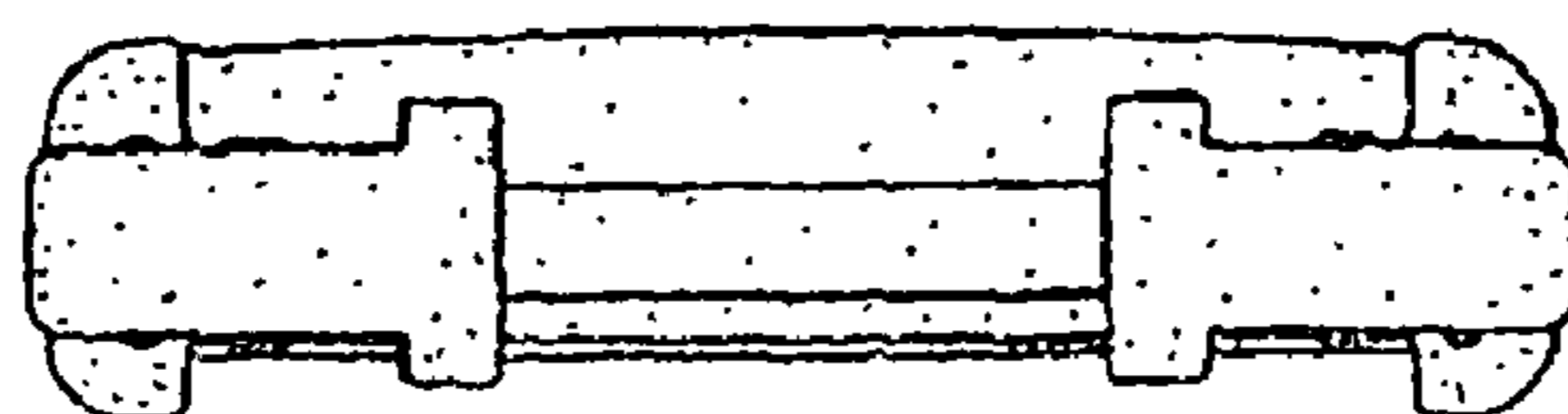

Fig. 16

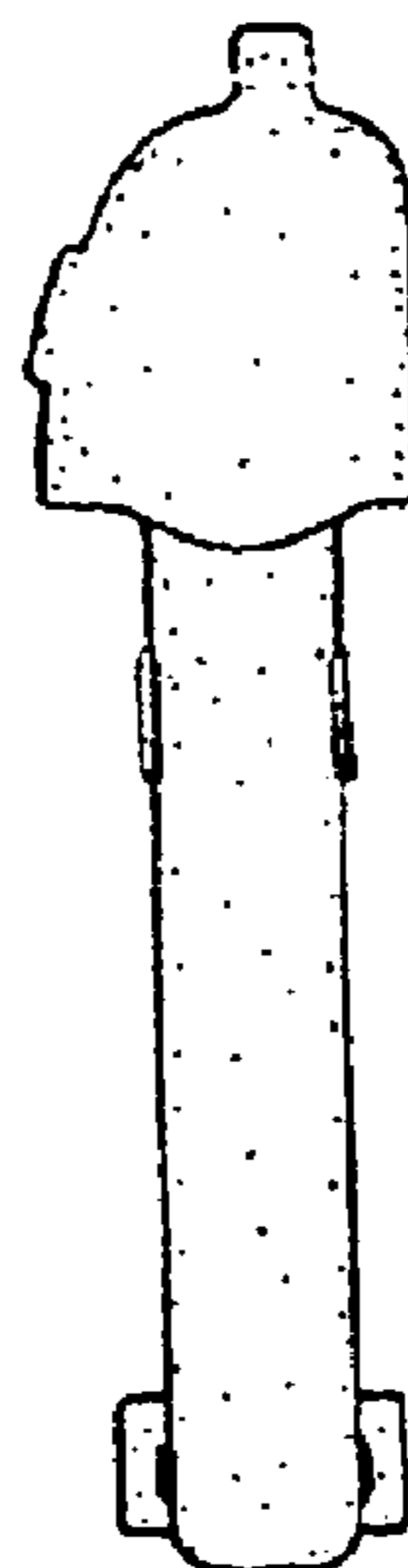

Fig. 17

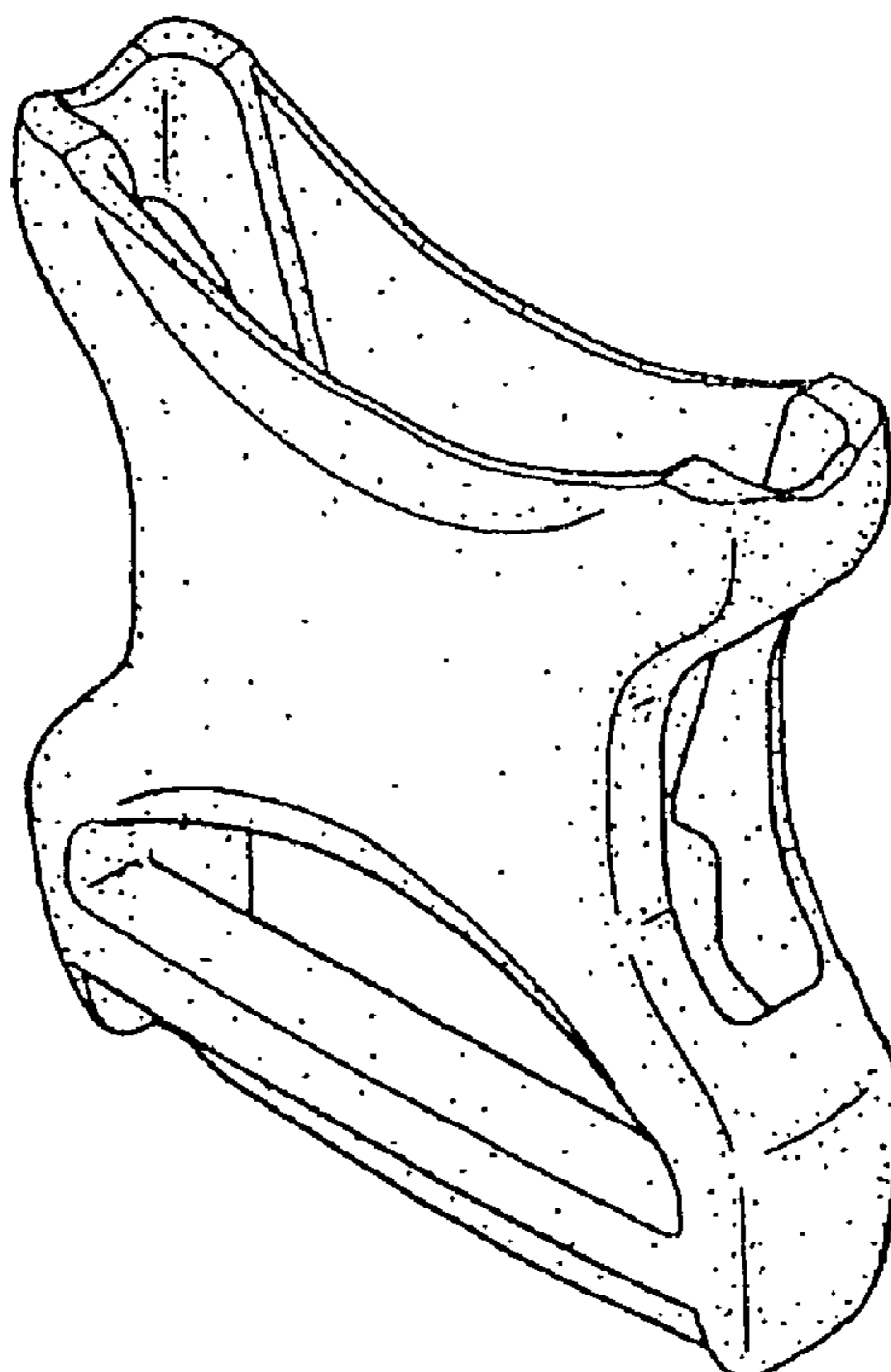

Fig. 18

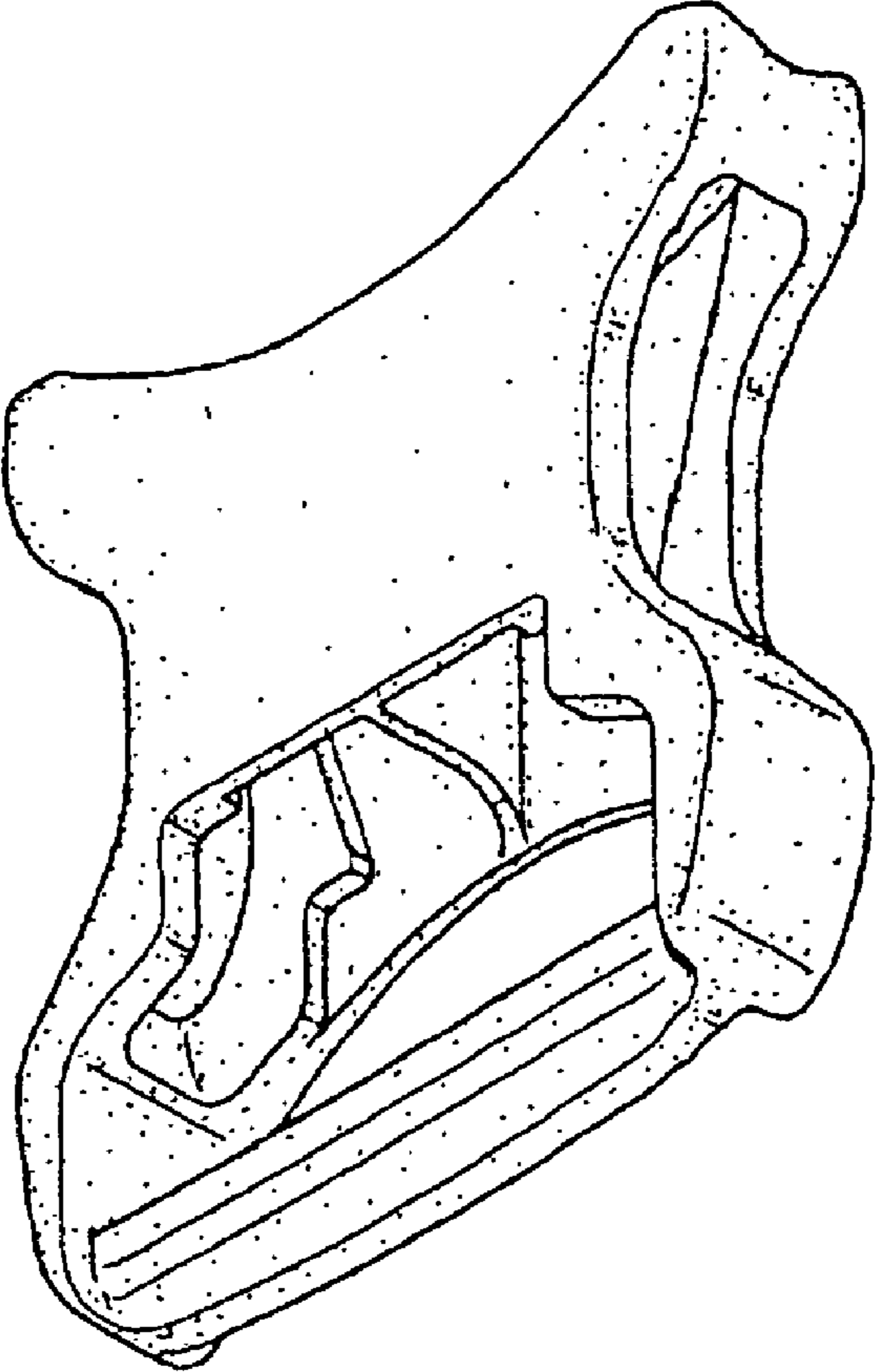

Fig. 19

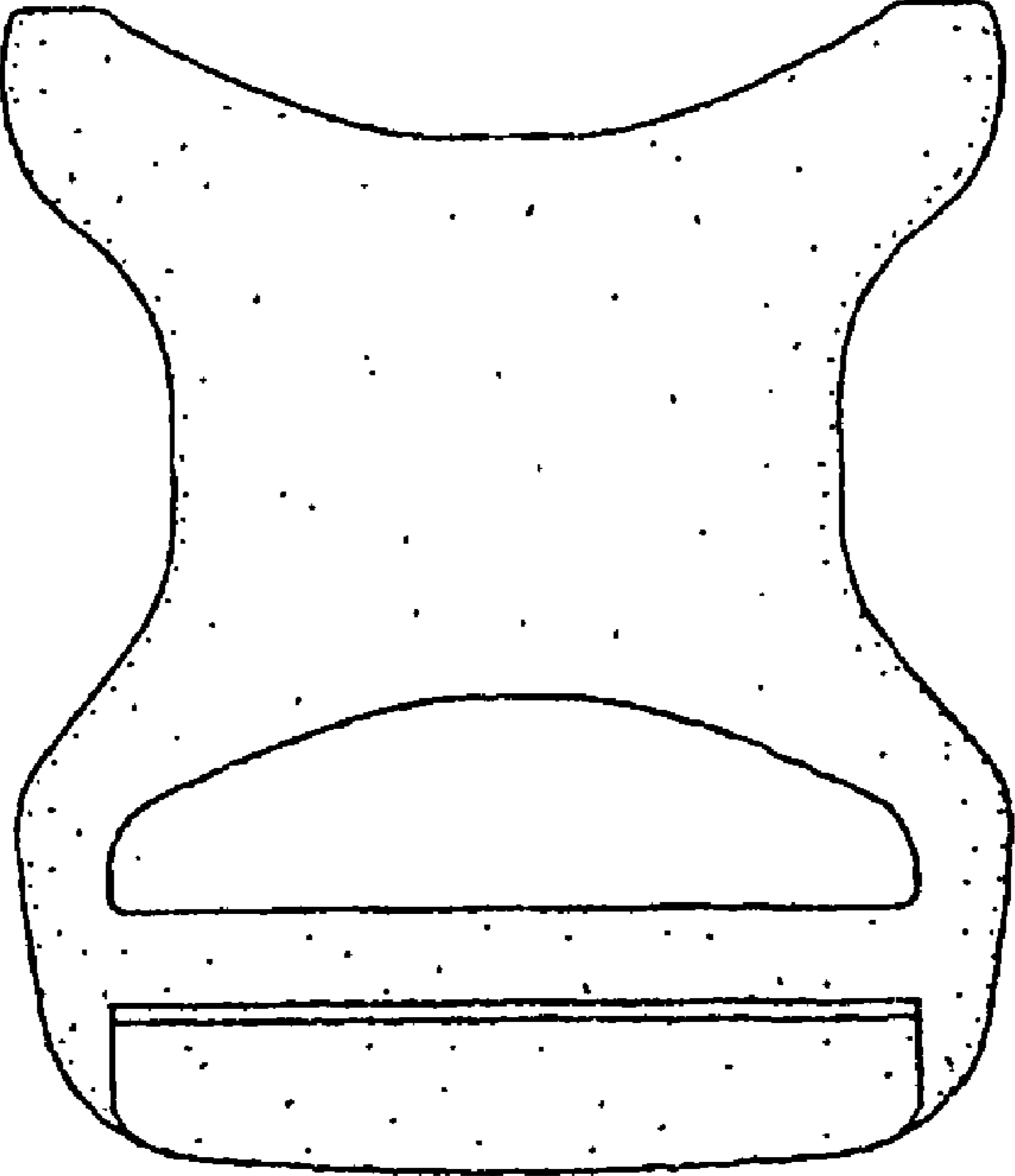

Fig. 20

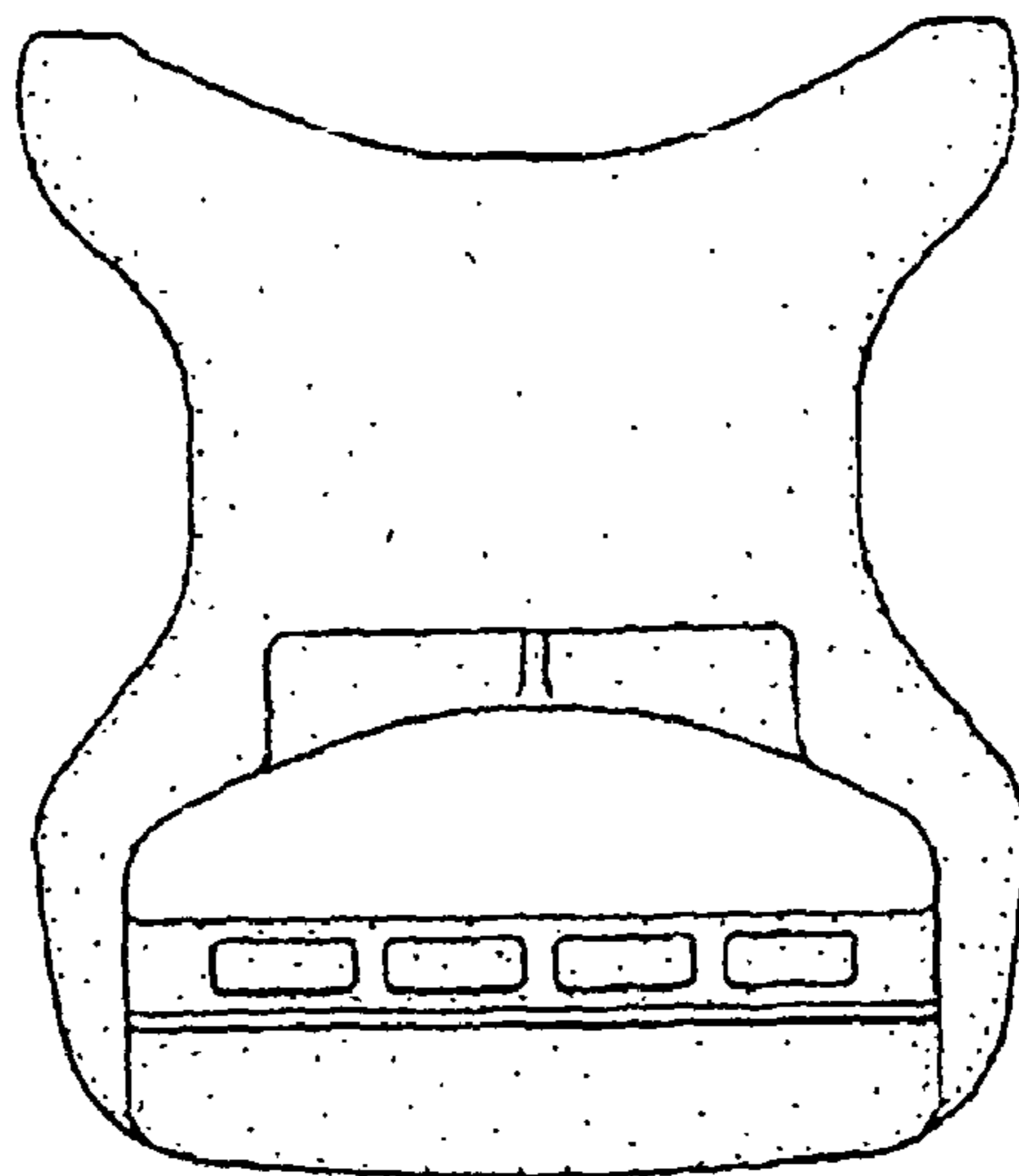

Fig. 21



Fig. 22

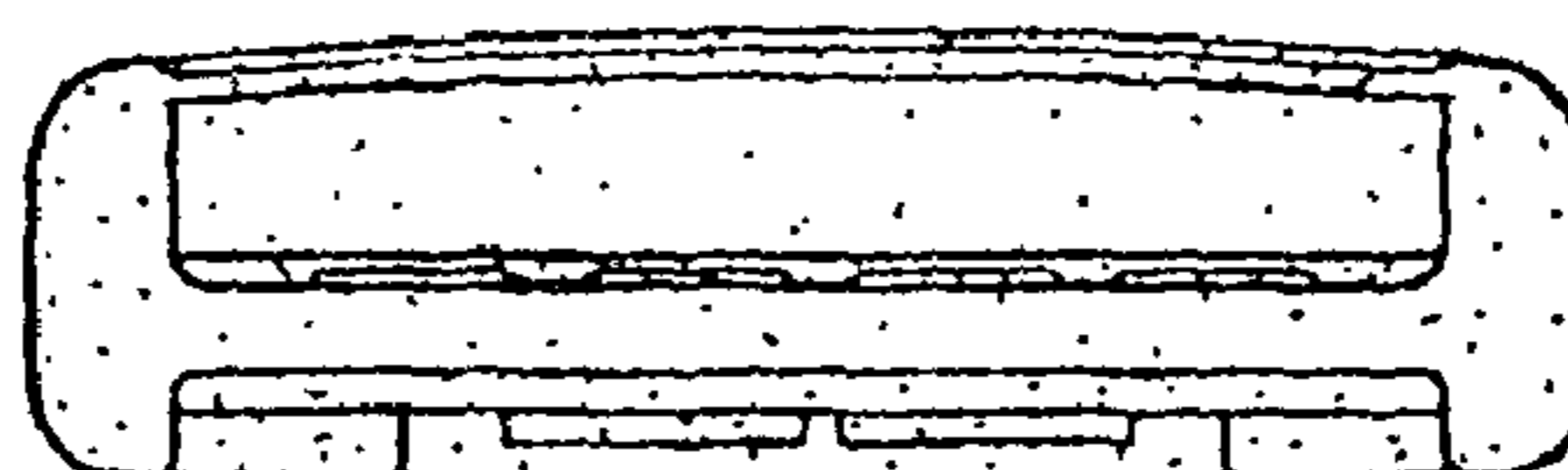

Fig. 23

