



US00D646877S

(12) **United States Design Patent**
LaRusso

(10) **Patent No.:** **US D646,877 S**

(45) **Date of Patent:** **** Oct. 18, 2011**

(54) **FOOTWEAR (FADE)**

(75) Inventor: **Nicholas LaRusso**, London (GB)

(73) Assignee: **J. Choo Limited**, London (GB)

(**) Term: **14 Years**

(21) Appl. No.: **29/370,013**

(22) Filed: **May 26, 2010**

(30) **Foreign Application Priority Data**

Nov. 26, 2009 (EP) 001181887-0007

(51) **LOC (9) Cl.** **02-99**

(52) **U.S. Cl.** **D2/971**

(58) **Field of Classification Search** D2/896,
D2/916-918, 925-942, 946, 969, 971; 36/1,
36/83, 8.3, 45-58, 104, 108, 76 R
See application file for complete search history.

(56) **References Cited**

U.S. PATENT DOCUMENTS

D88,313 S	11/1932	Miller	
D94,342 S	1/1935	Doring	
D166,890 S	5/1952	Stock	
D527,515 S	9/2006	Choi	
D536,166 S	2/2007	Choi	
D536,863 S *	2/2007	Choi	D2/971
D589,694 S *	4/2009	Guers-Neyraud	D2/971
D590,140 S *	4/2009	Della Valle	D2/925
D636,166 S *	4/2011	Guers-Neyraud	D2/971

* cited by examiner

Primary Examiner — Dominic Simone

(74) *Attorney, Agent, or Firm* — Fross Zelnick Lehrman & Zissu, P.C.; Lawrence E. Apolzon, Esq.

(57) **CLAIM**

The ornamental design for footwear (fade), as shown and described.

DESCRIPTION

FIG. 1 is a front perspective view of a shoe showing my footwear design;
 FIG. 2 is a left side view of the footwear shown in FIG. 1;
 FIG. 3 is a right side view of the footwear shown in FIG. 1;
 FIG. 4 is a front view of the footwear shown in FIG. 1;
 FIG. 5 is a rear view of the footwear shown in FIG. 1;
 FIG. 6 is a top view of the footwear shown in FIG. 1;
 FIG. 7 is a front perspective view of an alternative embodiment of the footwear shown in FIG. 1;
 FIG. 8 is a left side view of the alternative embodiment of the footwear shown in FIG. 7;
 FIG. 9 is a right side view of the alternative embodiment of the footwear shown in FIG. 7;
 FIG. 10 is a front view of the alternative embodiment of the footwear shown in FIG. 7;
 FIG. 11 is a rear view of the alternative embodiment of the footwear shown in FIG. 7; and,
 FIG. 12 is a top view of the alternative embodiment of the footwear shown in FIG. 7.
 The broken line showing of the sole, heel, heel cap, heel cup, rear portion of shoe upper, stitching, and footbed is for illustrative purposes only and forms no part of the claimed design.

1 Claim, 12 Drawing Sheets

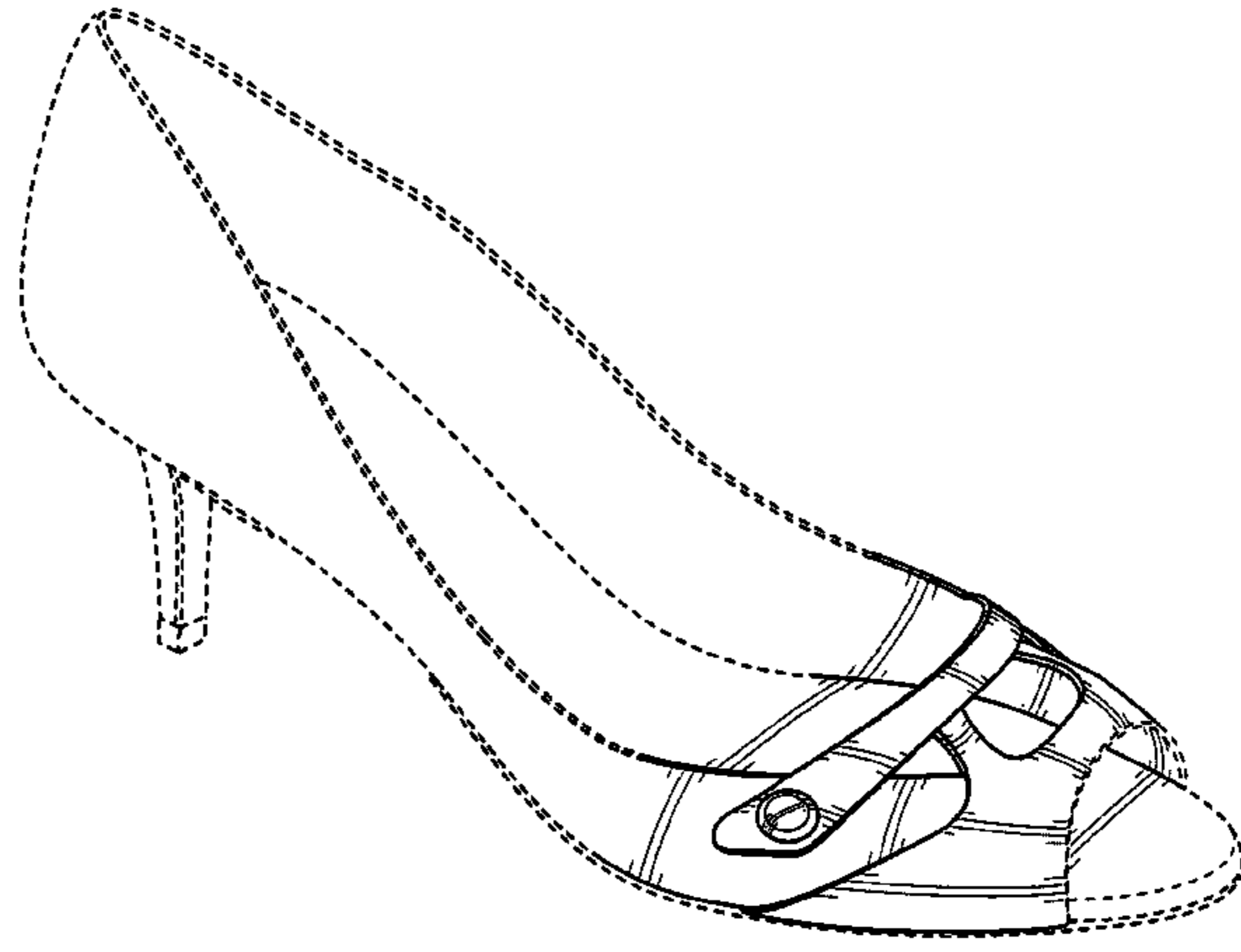
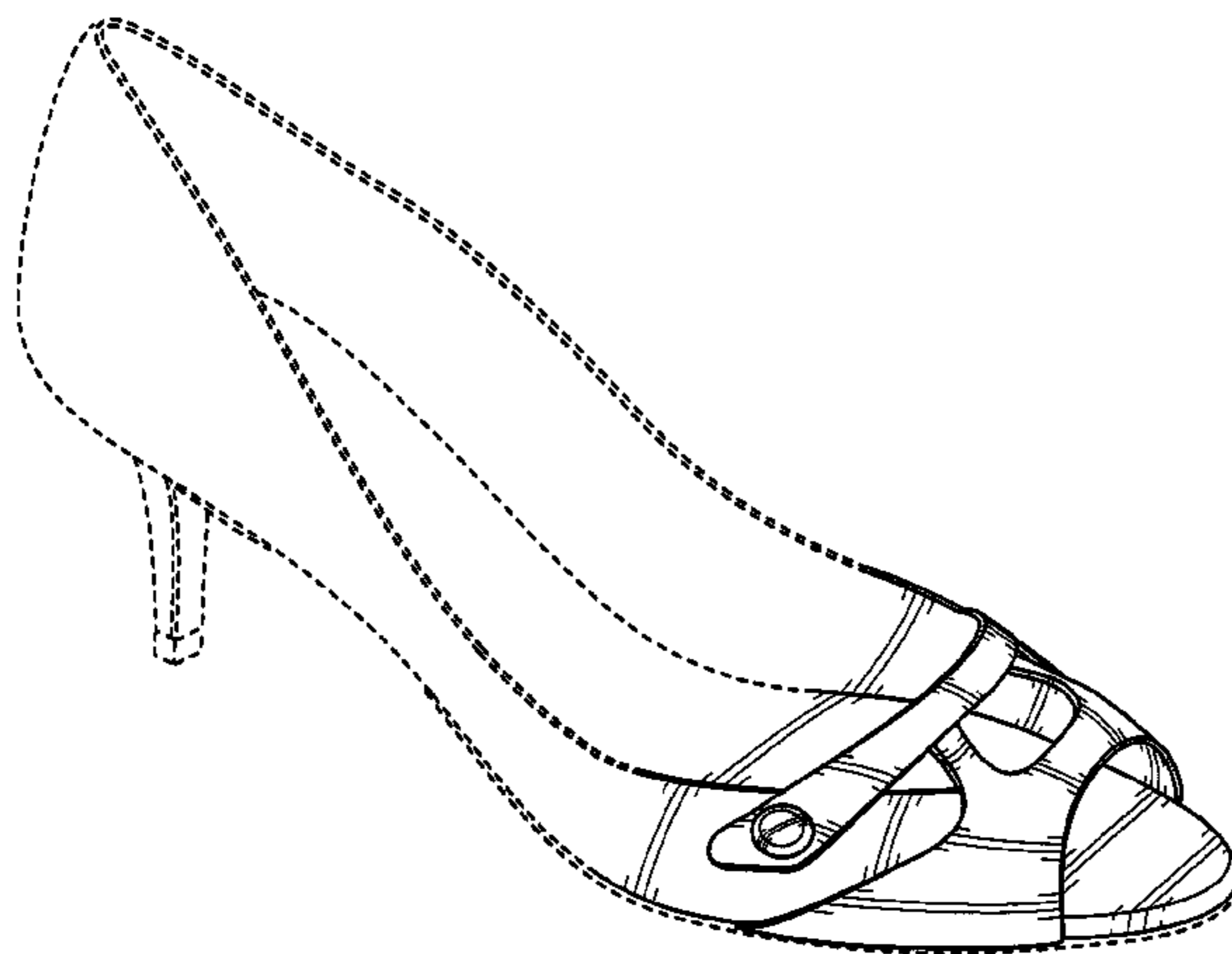

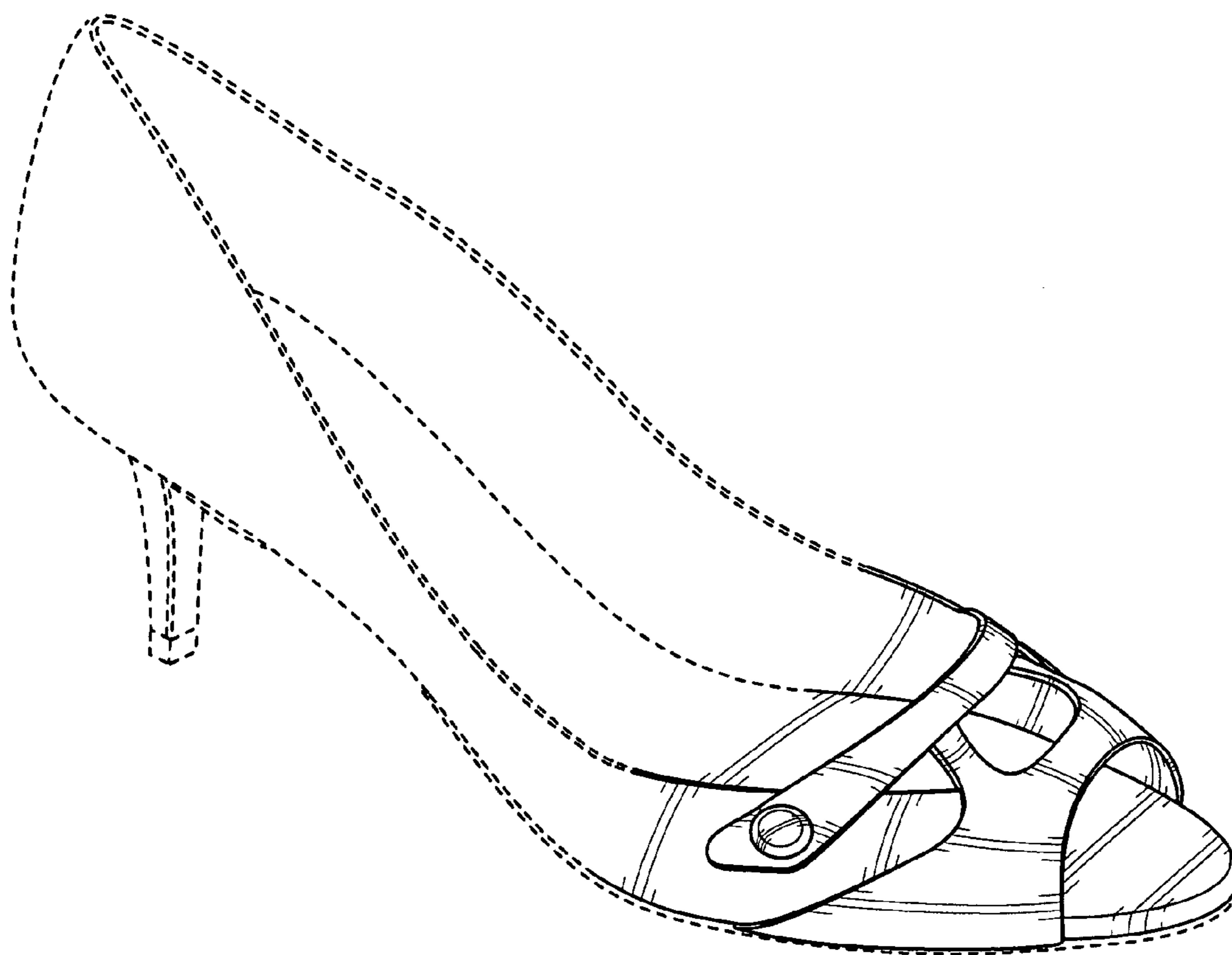

FIG. 1

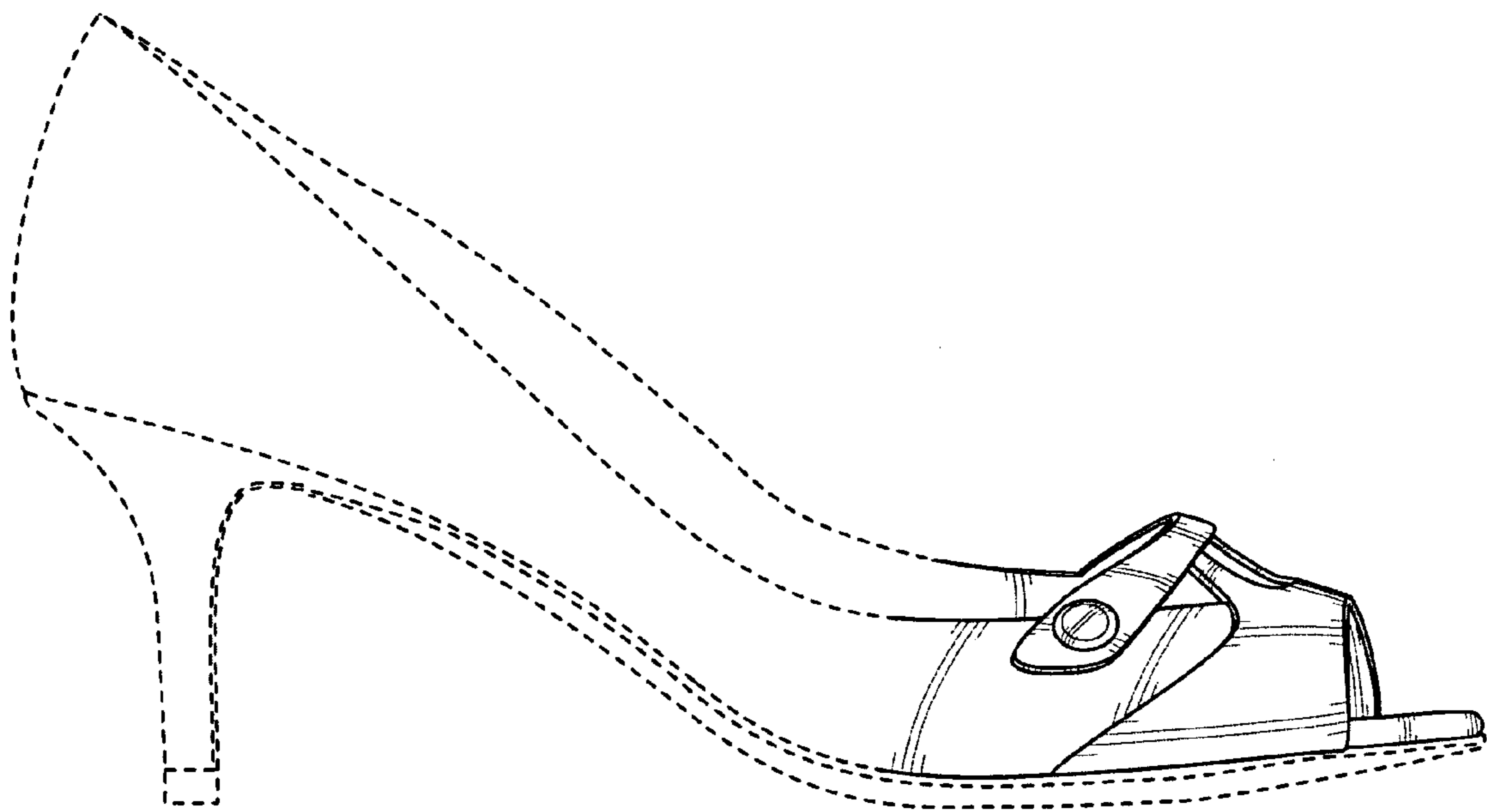

FIG. 2

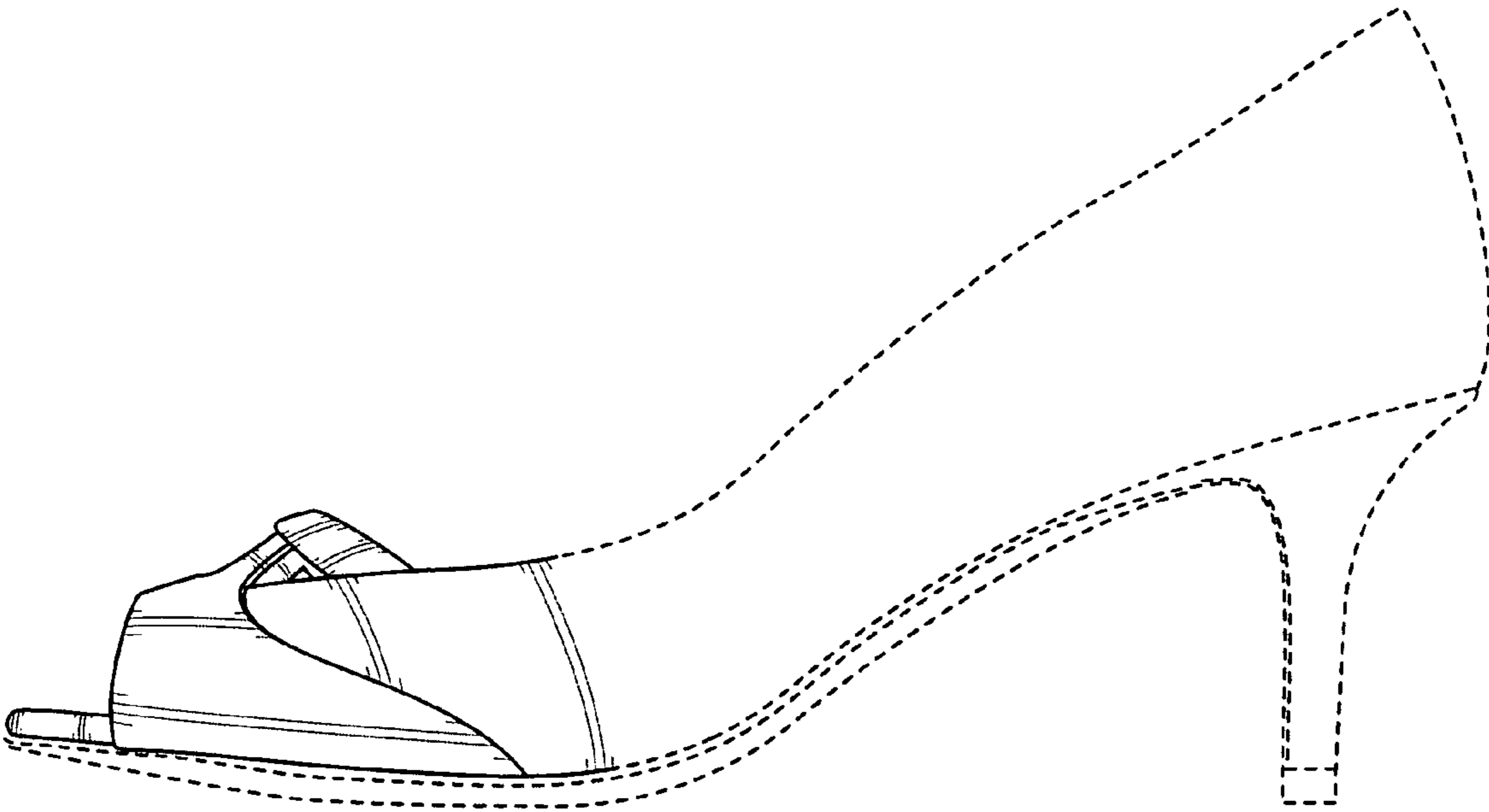

FIG. 3

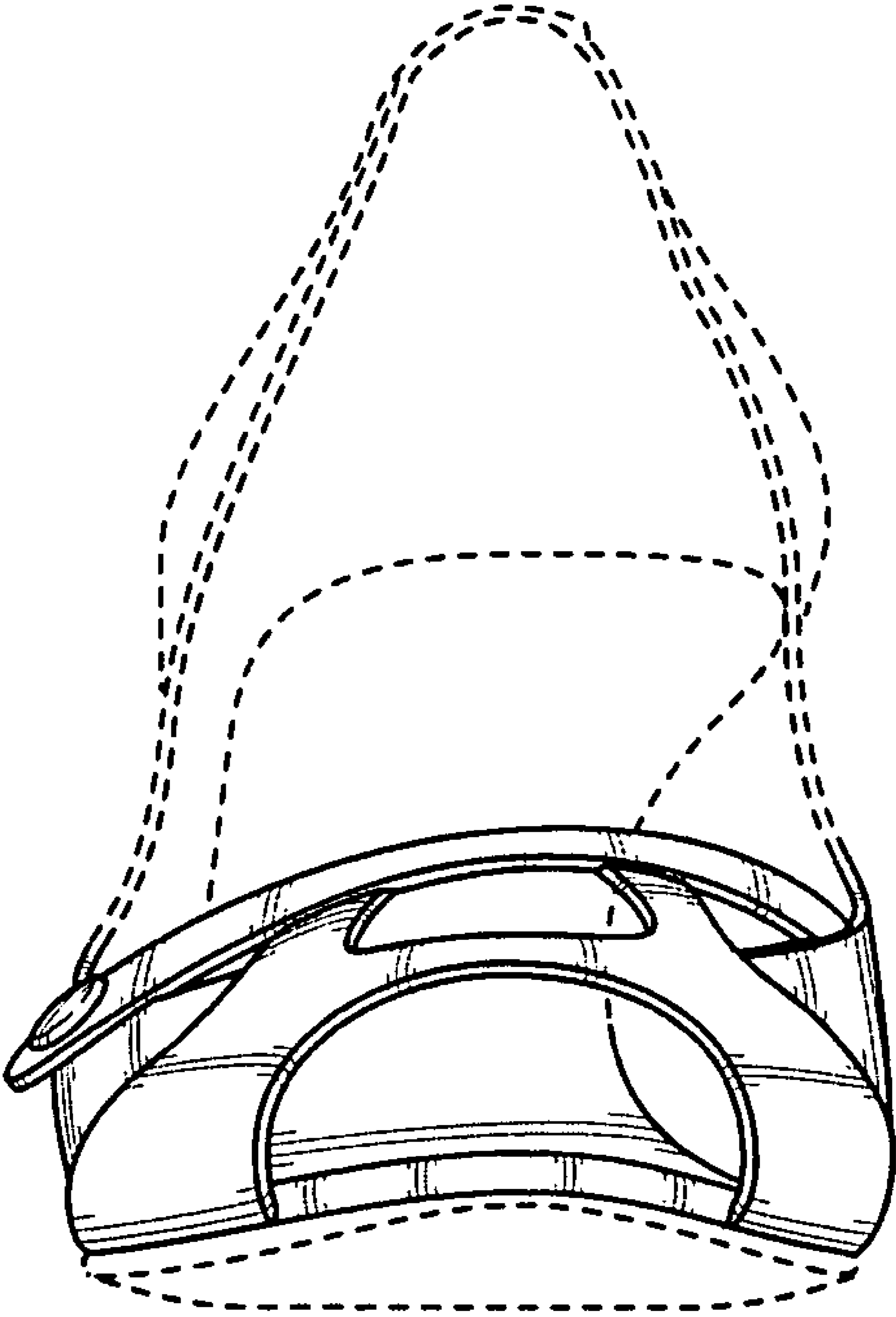

FIG. 4

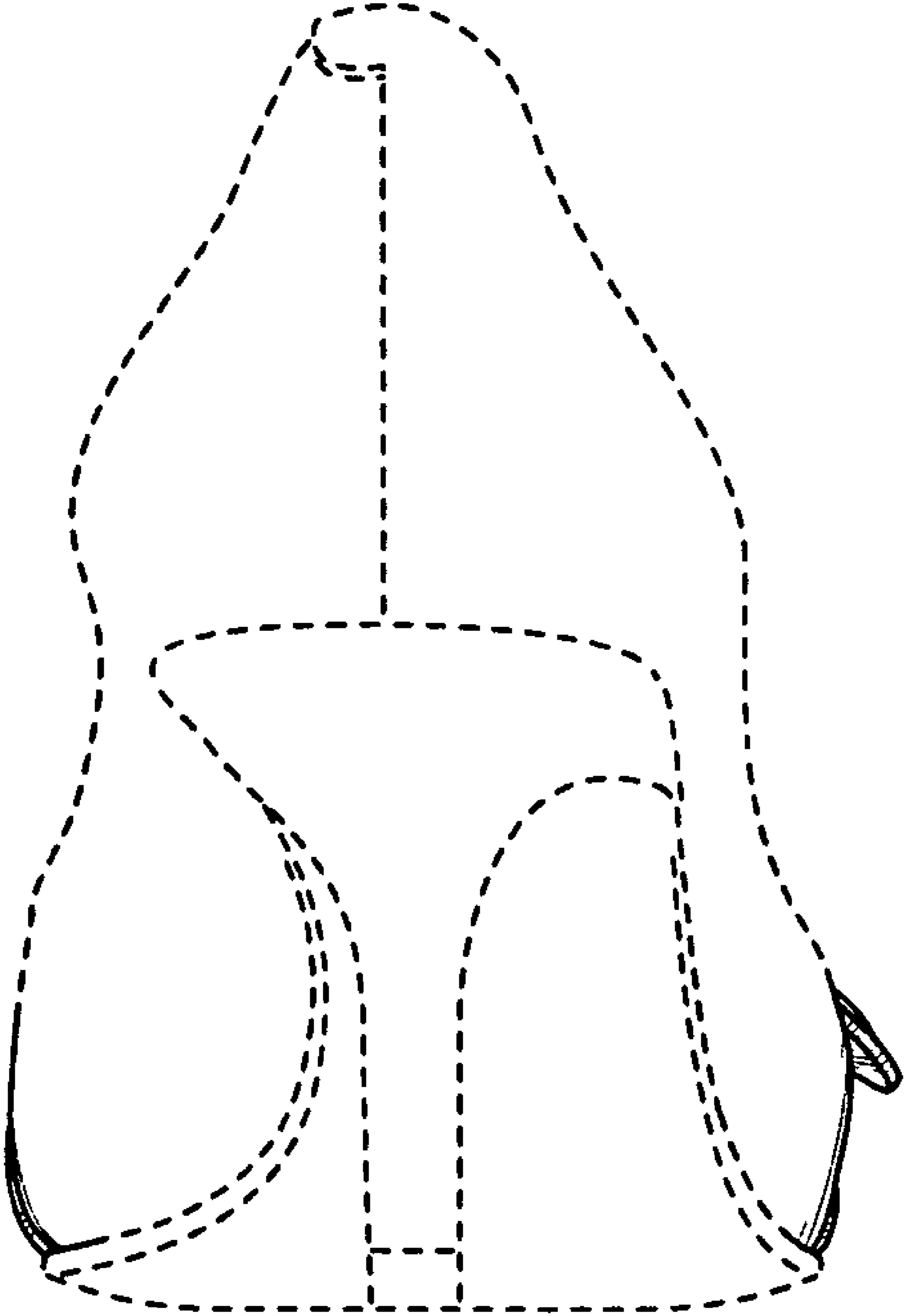

FIG. 5

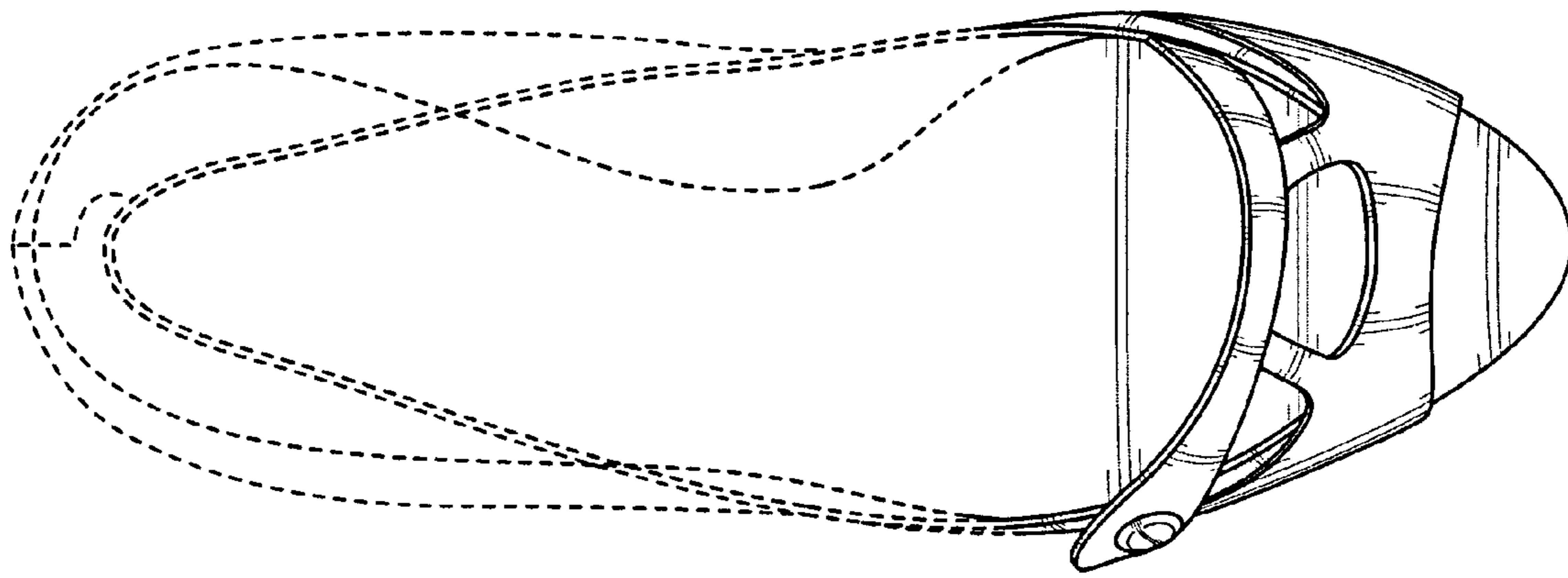

FIG. 6

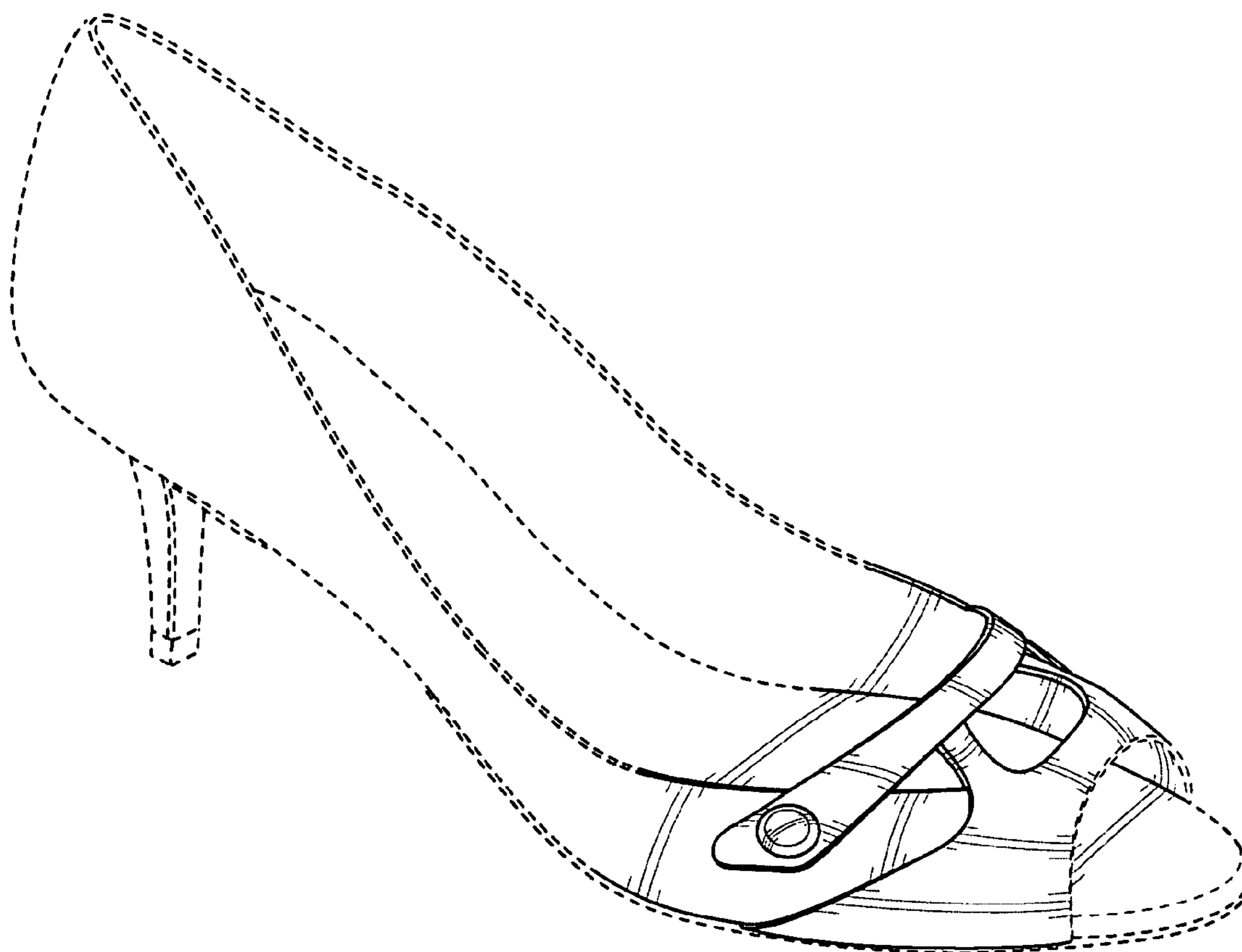

FIG. 7

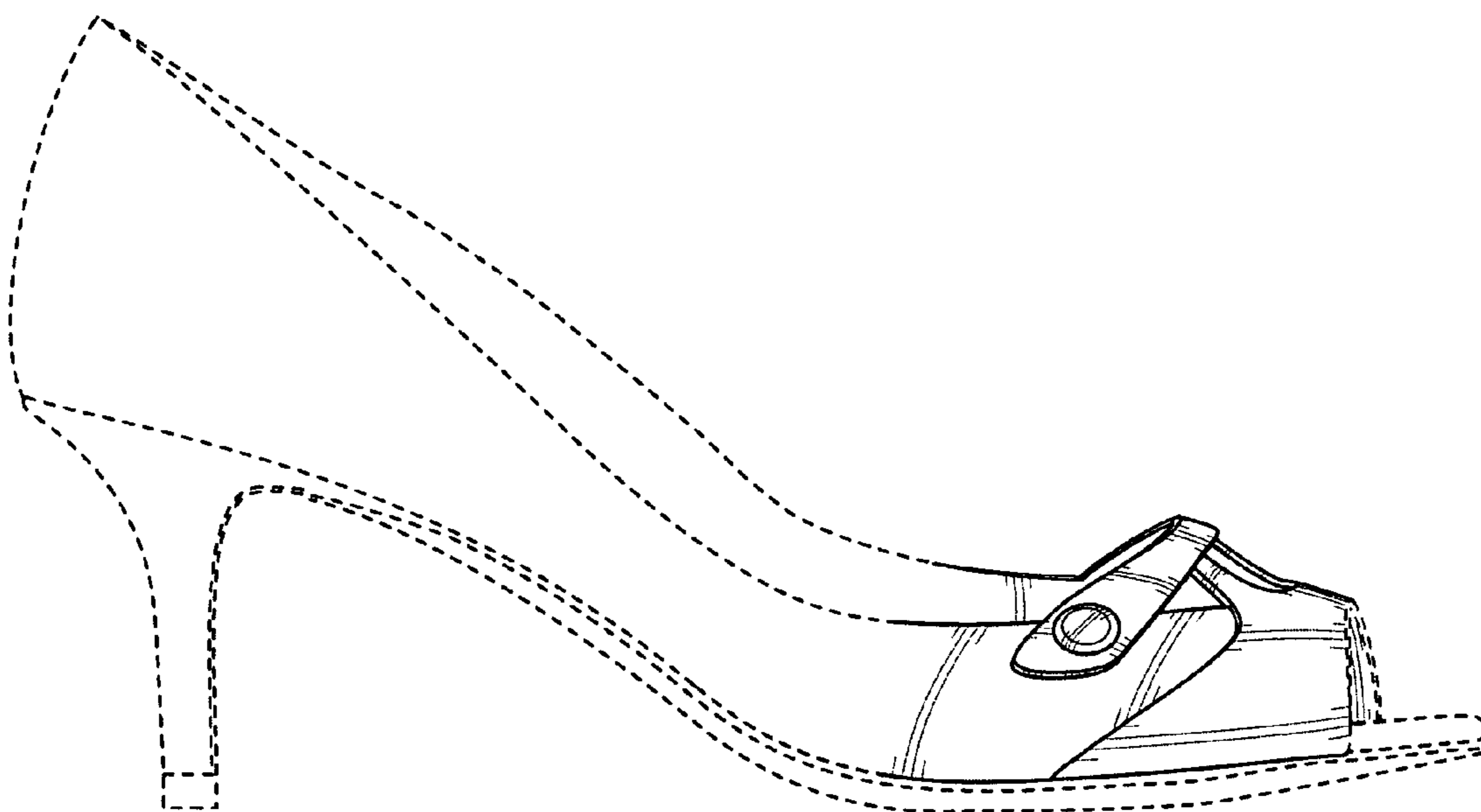

FIG. 8

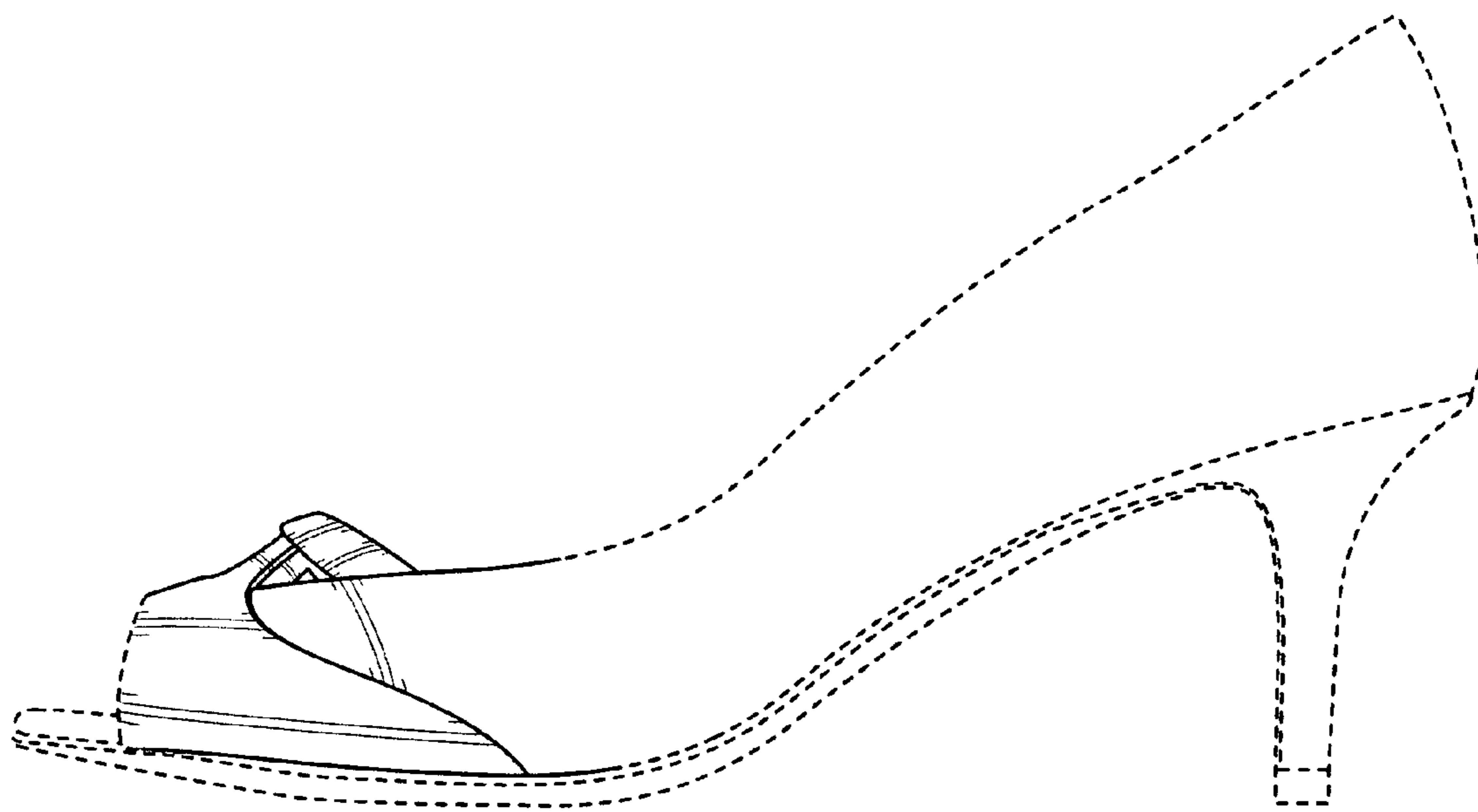

FIG. 9

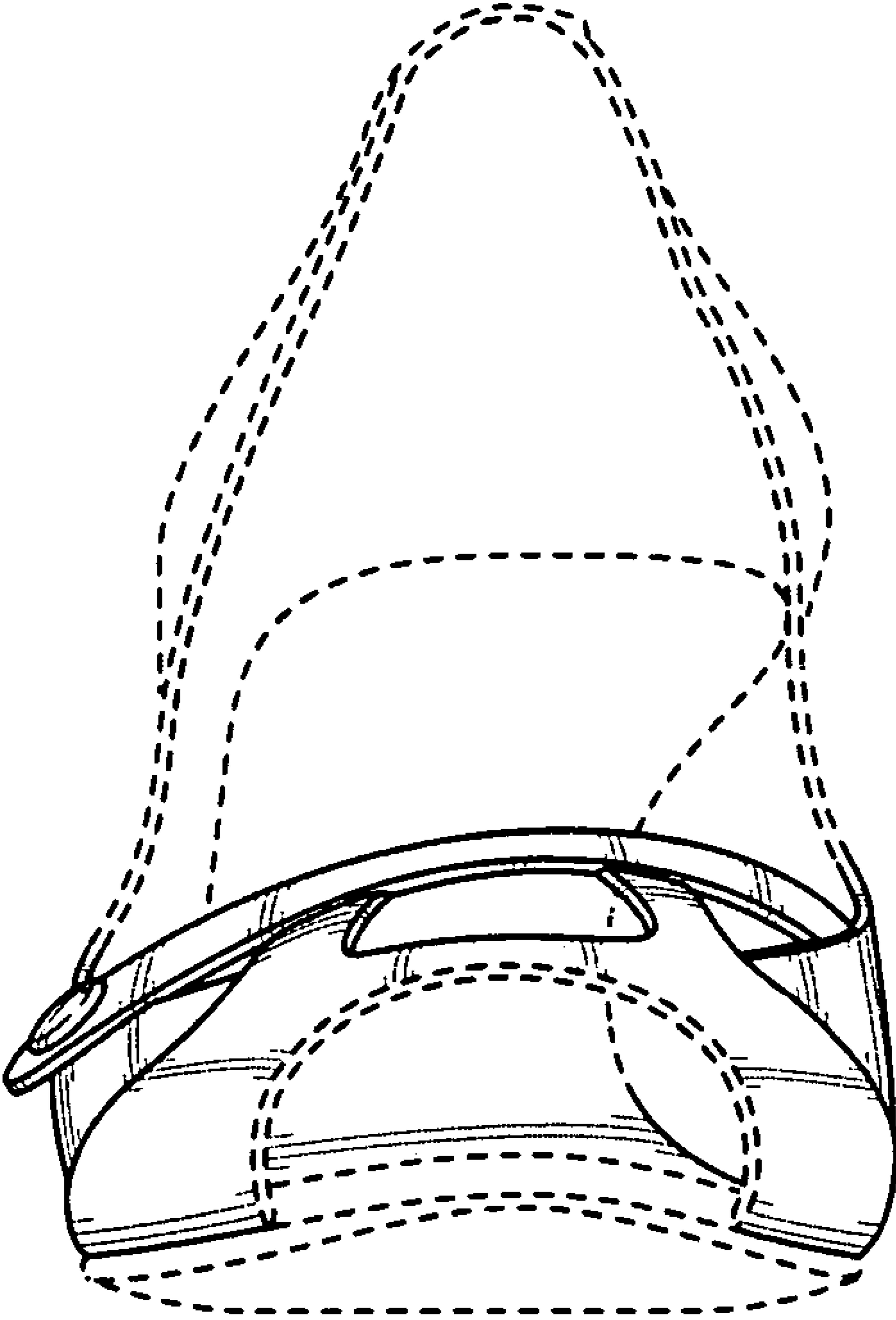

FIG. 10

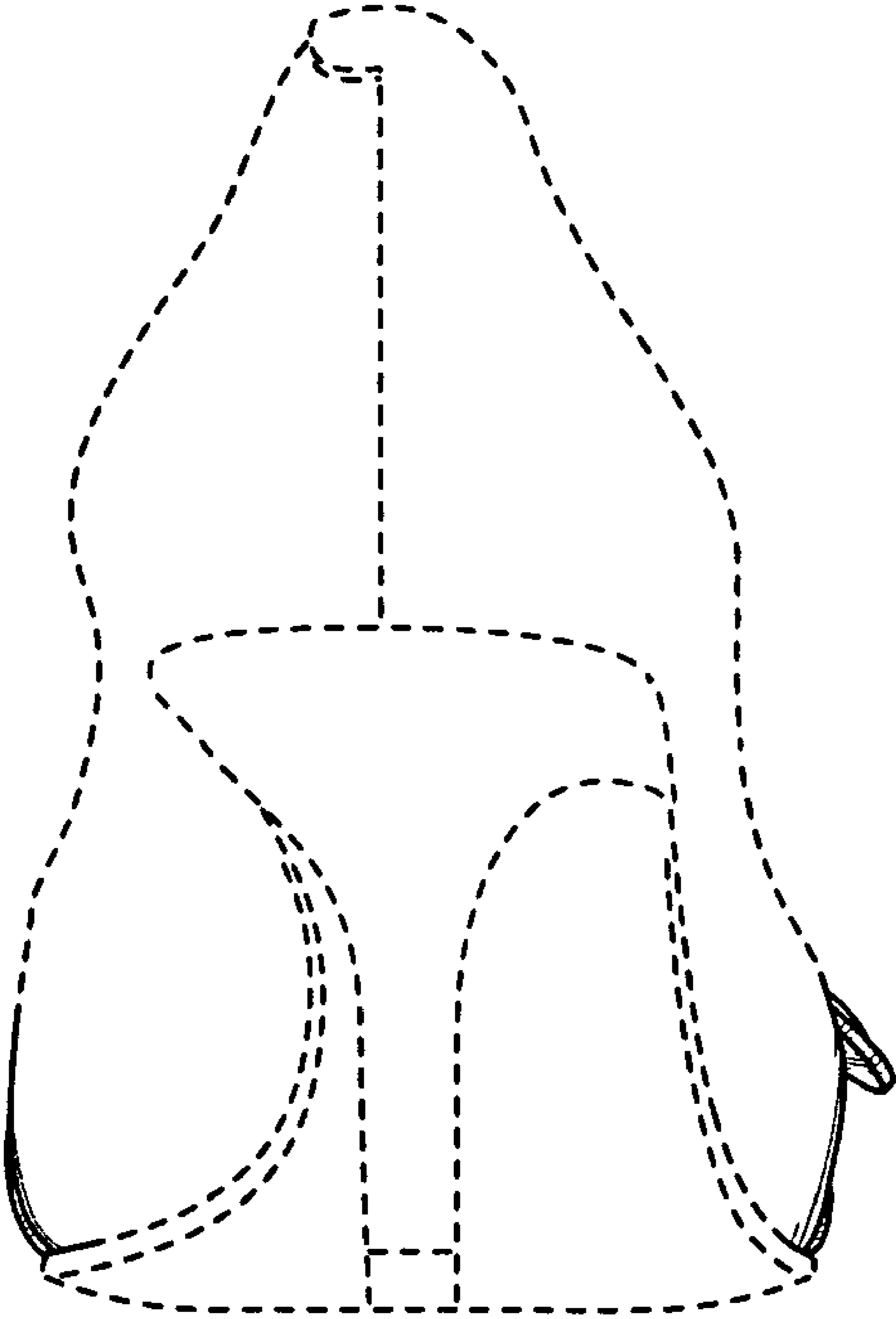

FIG. 11

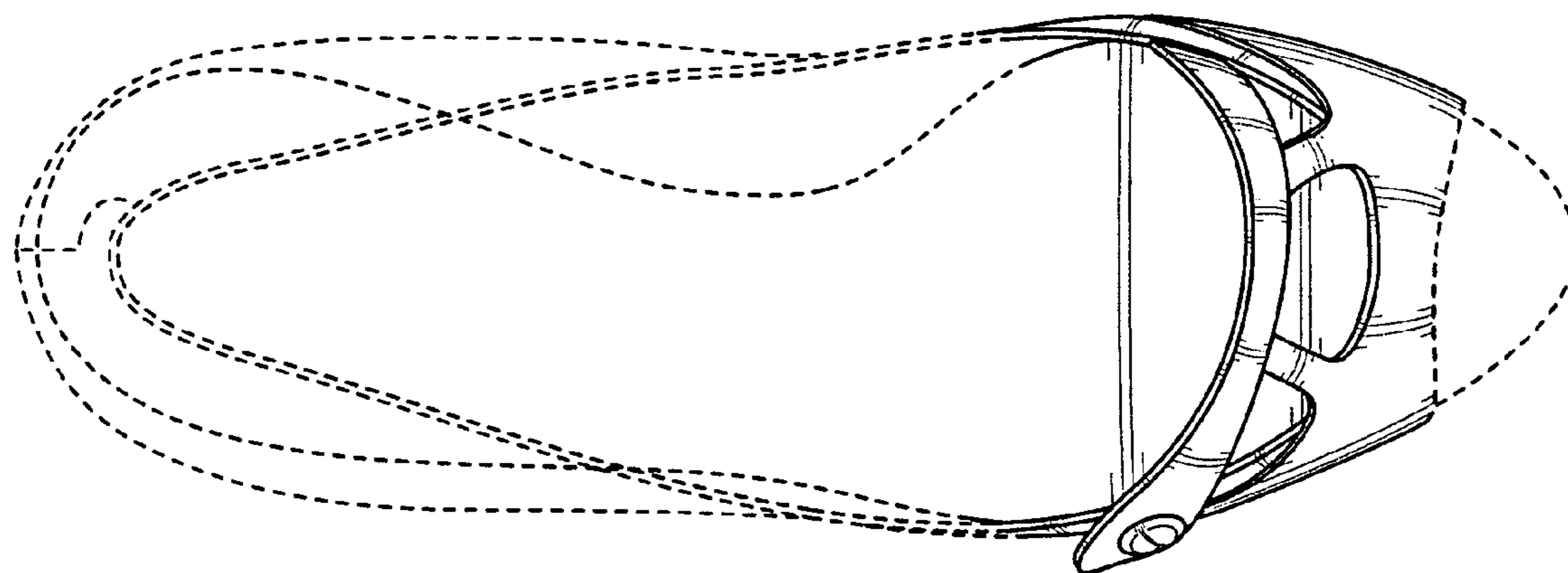

FIG. 12