



US00D646863S

(12) **United States Design Patent**
Hosoda et al.

(10) **Patent No.:** **US D646,863 S**

(45) **Date of Patent:** **** Oct. 11, 2011**

(54) **STEAM IRON**

(75) Inventors: **Syuuichi Hosoda**, Shiga (JP); **Kiyoaki Konno**, Nara (JP)

(73) Assignee: **Panasonic Corporation**, Osaka (JP)

(**) Term: **14 Years**

(21) Appl. No.: **29/388,680**

(22) Filed: **Mar. 31, 2011**

(51) **LOC (9) Cl.** **07-05**

(52) **U.S. Cl.** **D32/70**

(58) **Field of Classification Search** D32/73,
D32/72, 71, 70, 69, 68, 35; 392/404; 38/97,
38/96, 93, 88, 77.9, 77.83, 77.82, 77.81,
38/77.8, 77.7, 77.6, 77.5, 77.3, 77.1; 219/251,
219/245

See application file for complete search history.

(56) **References Cited**

U.S. PATENT DOCUMENTS

D386,863 S *	11/1997	Lin	D32/70
D409,807 S *	5/1999	Kondo	D32/70
D423,162 S *	4/2000	Sugimoto et al.	D32/70
D425,278 S *	5/2000	Yang	D32/70
D428,541 S *	7/2000	Bas	D32/70
D441,930 S *	5/2001	Choi	D32/70
D478,401 S *	8/2003	Lee	D32/70
D490,953 S *	6/2004	Fujita	D32/70
D509,936 S *	9/2005	Barquin Santillan	D32/70
D515,762 S *	2/2006	Kihara	D32/70
D516,764 S *	3/2006	Kihara	D32/70
D530,873 S *	10/2006	Poon	D32/70
D531,369 S *	10/2006	Archer et al.	D32/70
D537,593 S *	2/2007	Takahashi et al.	D32/70
D537,594 S *	2/2007	Takahashi et al.	D32/70
D538,498 S *	3/2007	Picozza et al.	D32/70
D582,620 S	12/2008	Brown	

D594,165 S *	6/2009	Mizoguchi	D32/70
D594,166 S *	6/2009	Mizoguchi	D32/70
D629,991 S *	12/2010	Day et al.	D32/70
D632,863 S *	2/2011	Massip et al.	D32/70
D634,090 S *	3/2011	Massip et al.	D32/70

FOREIGN PATENT DOCUMENTS

CN 200730113487.5 8/2007

* cited by examiner

Primary Examiner — Austin Murphy

(74) *Attorney, Agent, or Firm* — Brinks Hofer Gilson & Lione

(57) **CLAIM**

We claim the ornamental design for a steam iron, as shown and described.

DESCRIPTION

FIG. 1 is a top perspective view of a first embodiment of a steam iron of the present invention;
 FIG. 2 is a front view thereof;
 FIG. 3 is a rear view thereof;
 FIG. 4 is a first side view thereof;
 FIG. 5 is a second side view thereof;
 FIG. 6 is a top view thereof;
 FIG. 7 is a bottom view thereof;
 FIG. 8 is a top perspective view of a second embodiment of a steam iron of the present invention;
 FIG. 9 is a front view thereof;
 FIG. 10 is a rear view thereof;
 FIG. 11 is a first side view thereof;
 FIG. 12 is a second side view thereof;
 FIG. 13 is a top view thereof; and,
 FIG. 14 is a bottom view thereof.

The broken lines shown in FIGS. 7 and 14 represent portions of the iron that form no part of the claimed design.

1 Claim, 14 Drawing Sheets

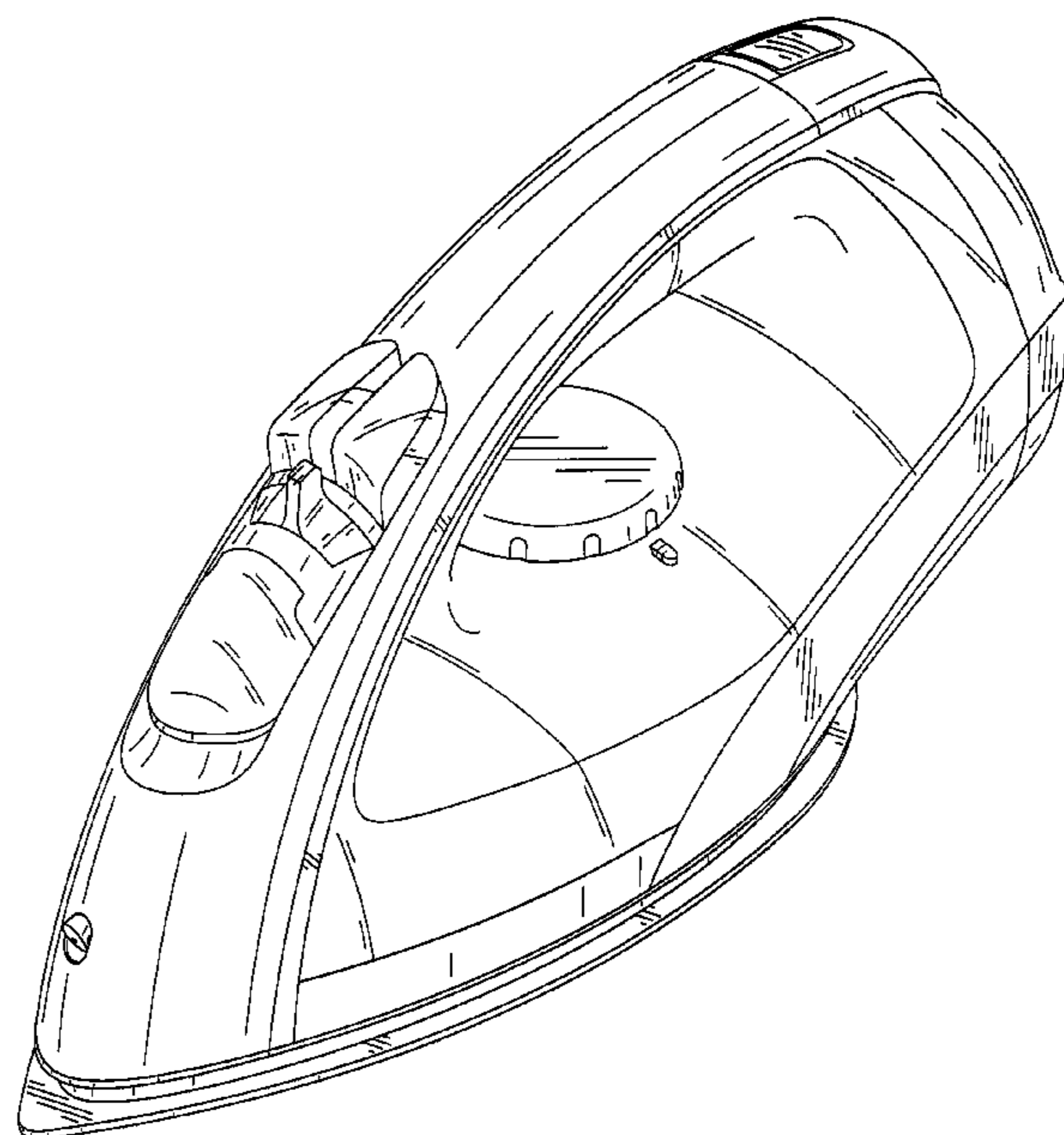
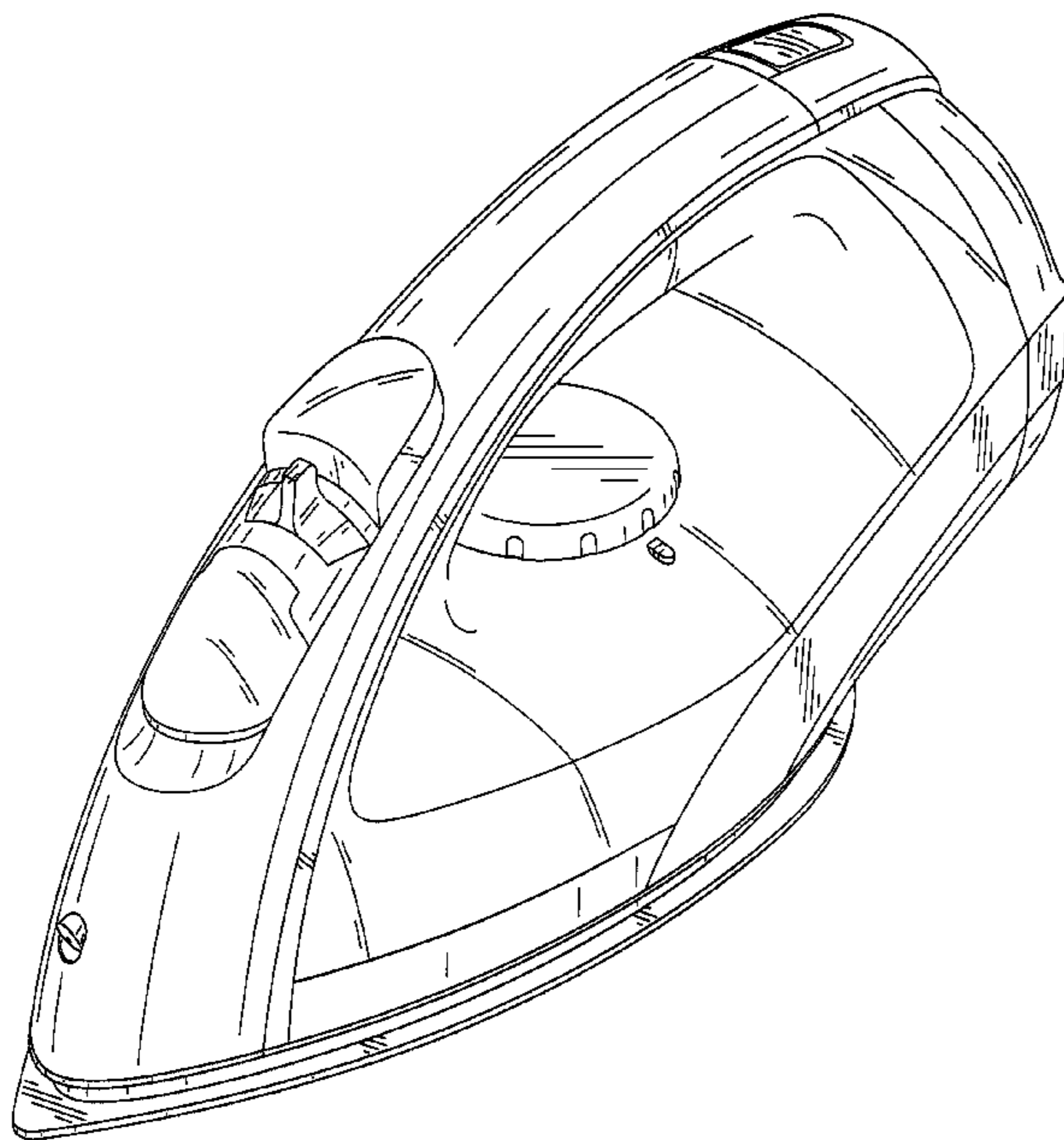

FIG.1

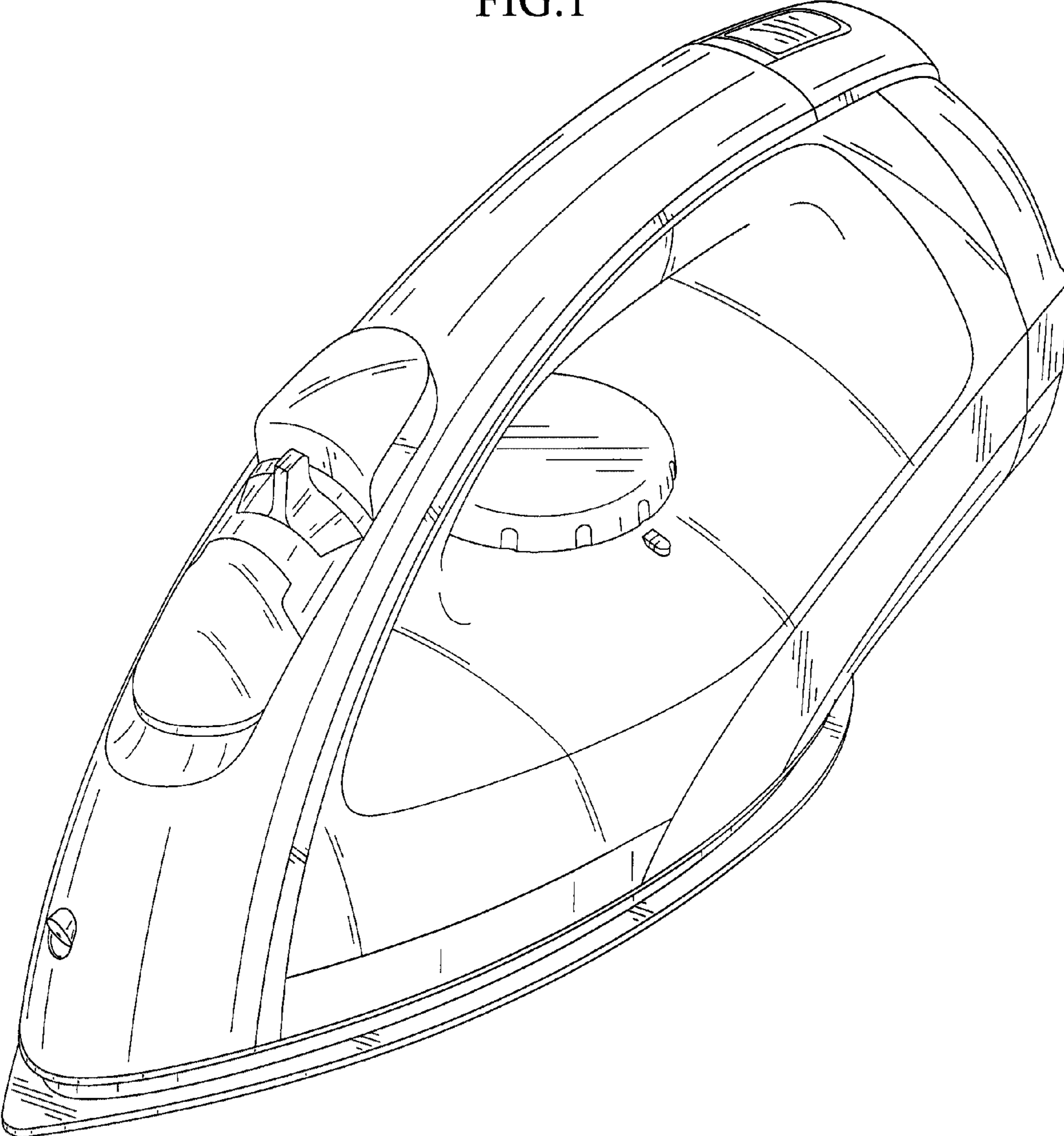

FIG.2

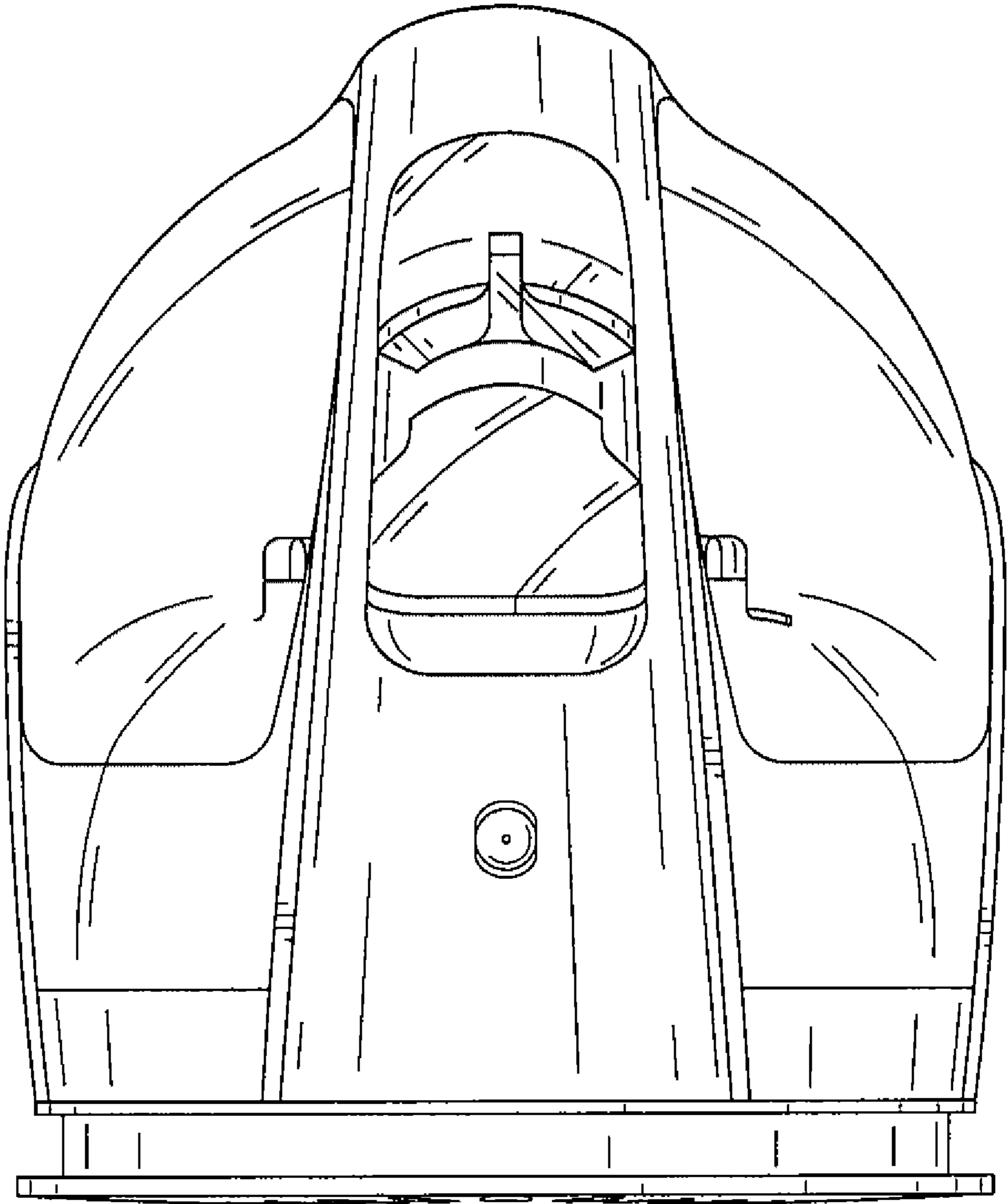

FIG.3

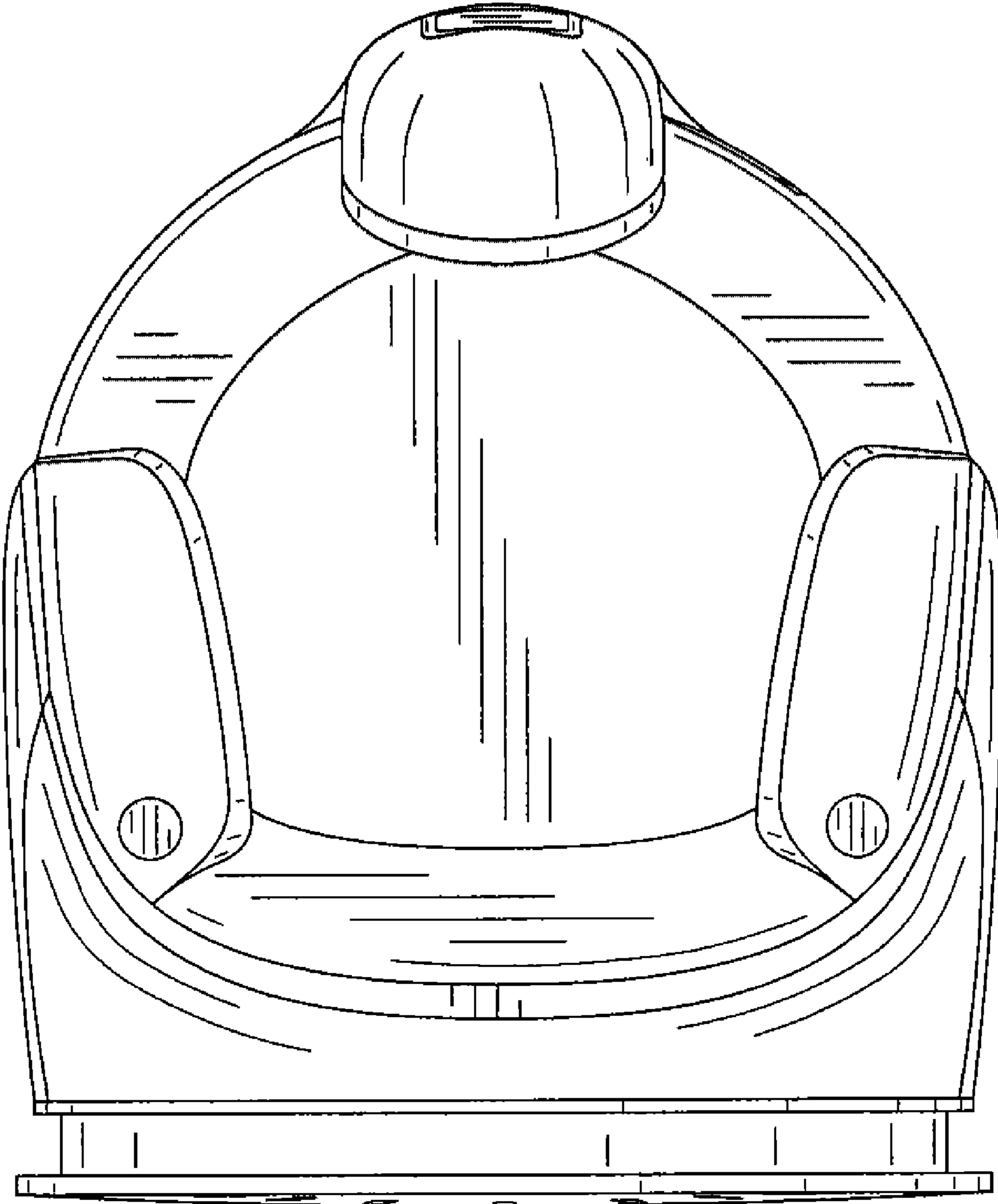

FIG.4

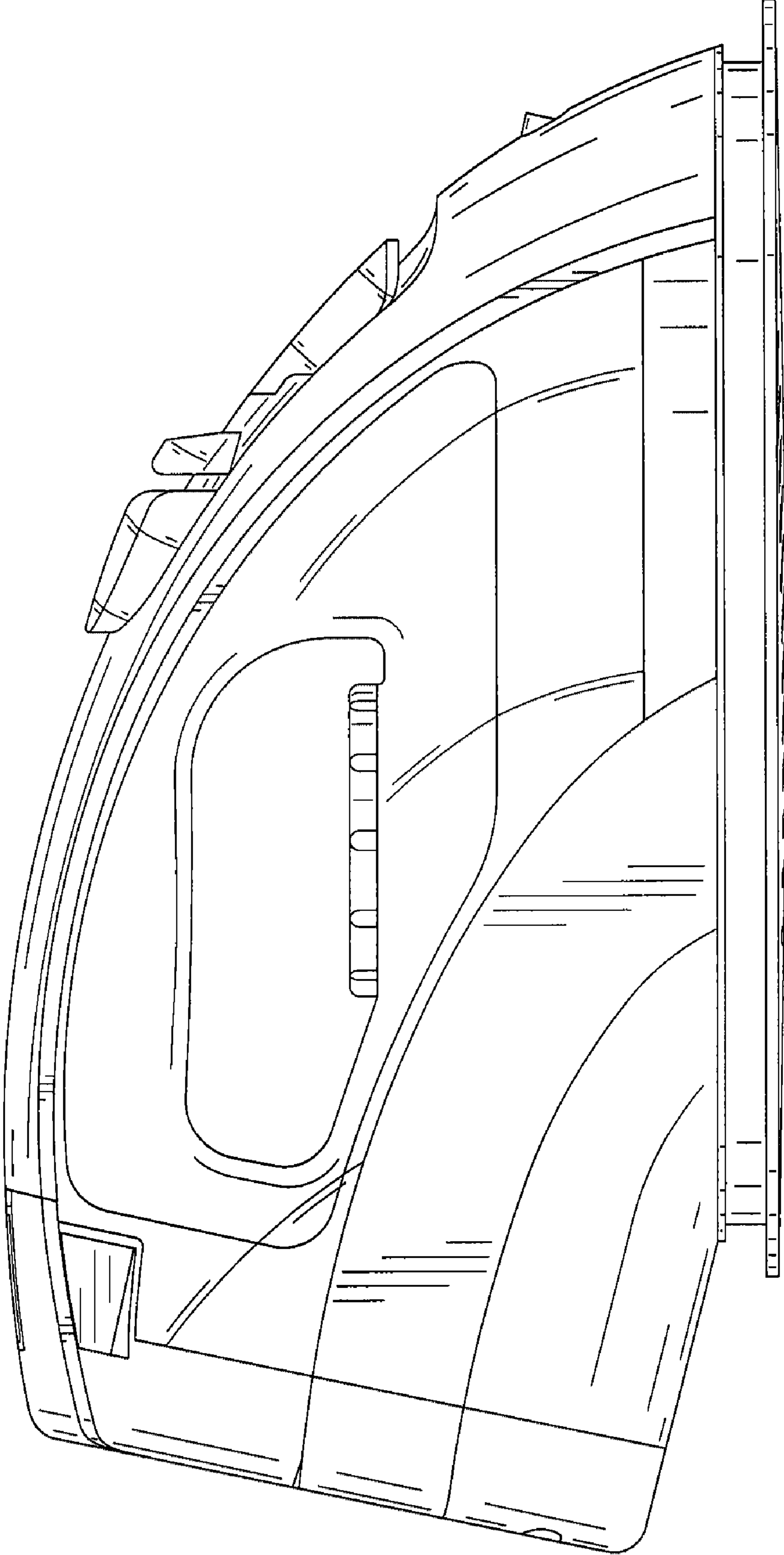

FIG. 5

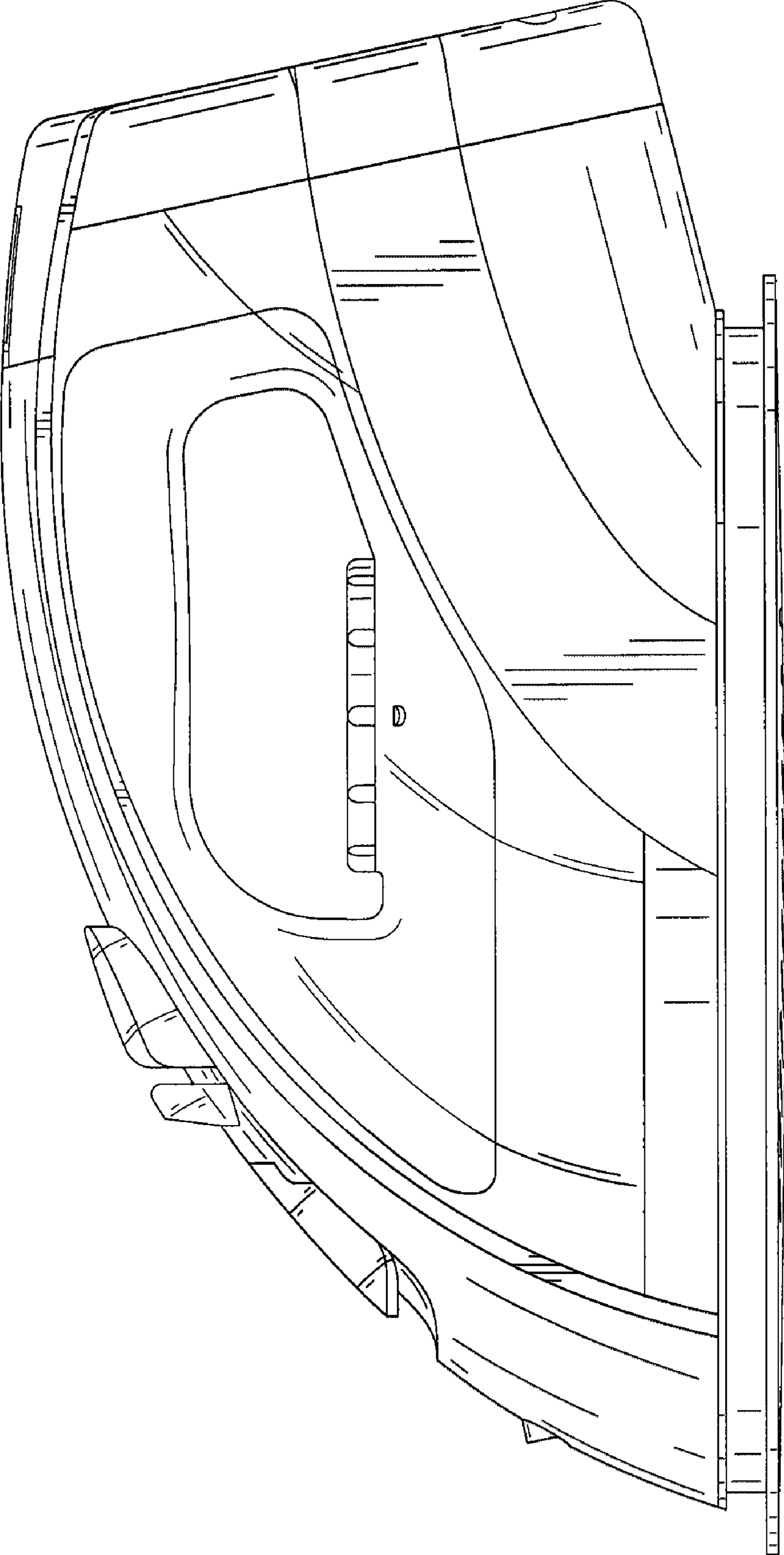

FIG.6

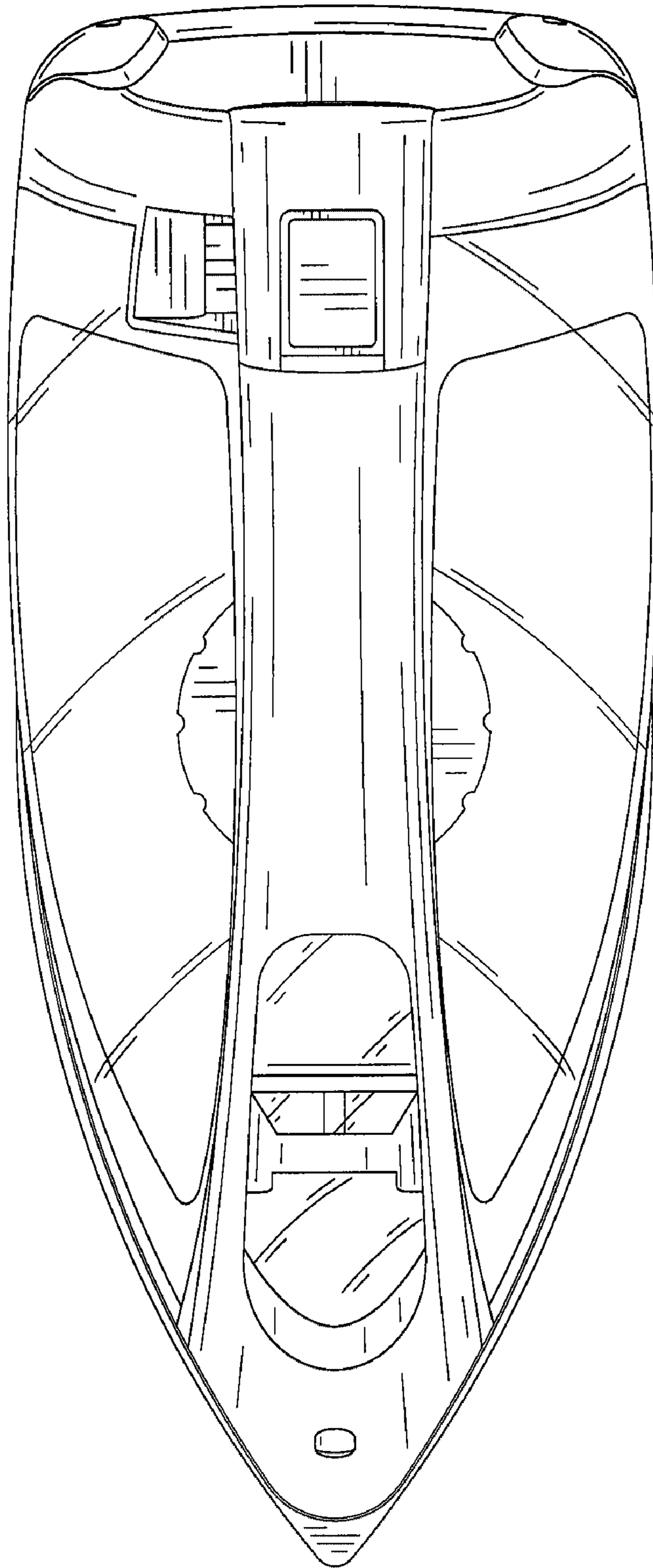

FIG. 7

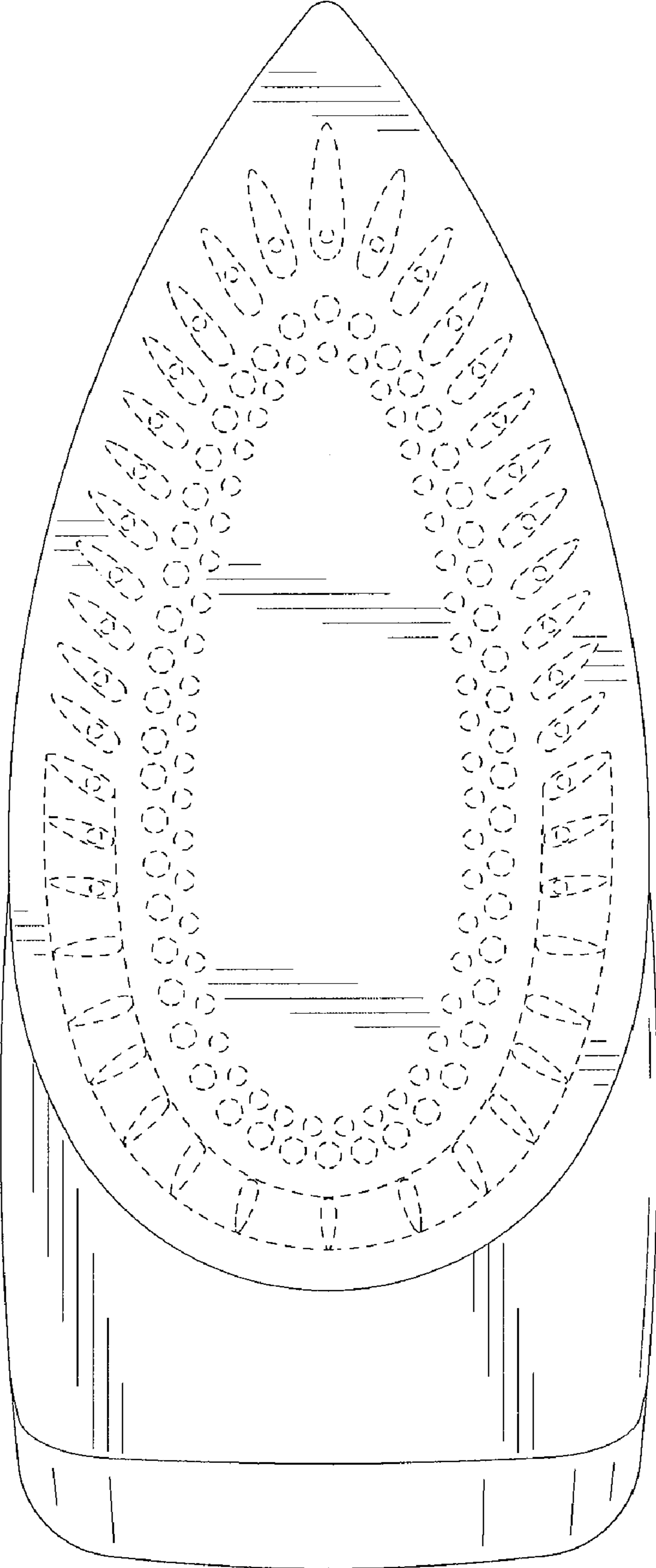

FIG.8

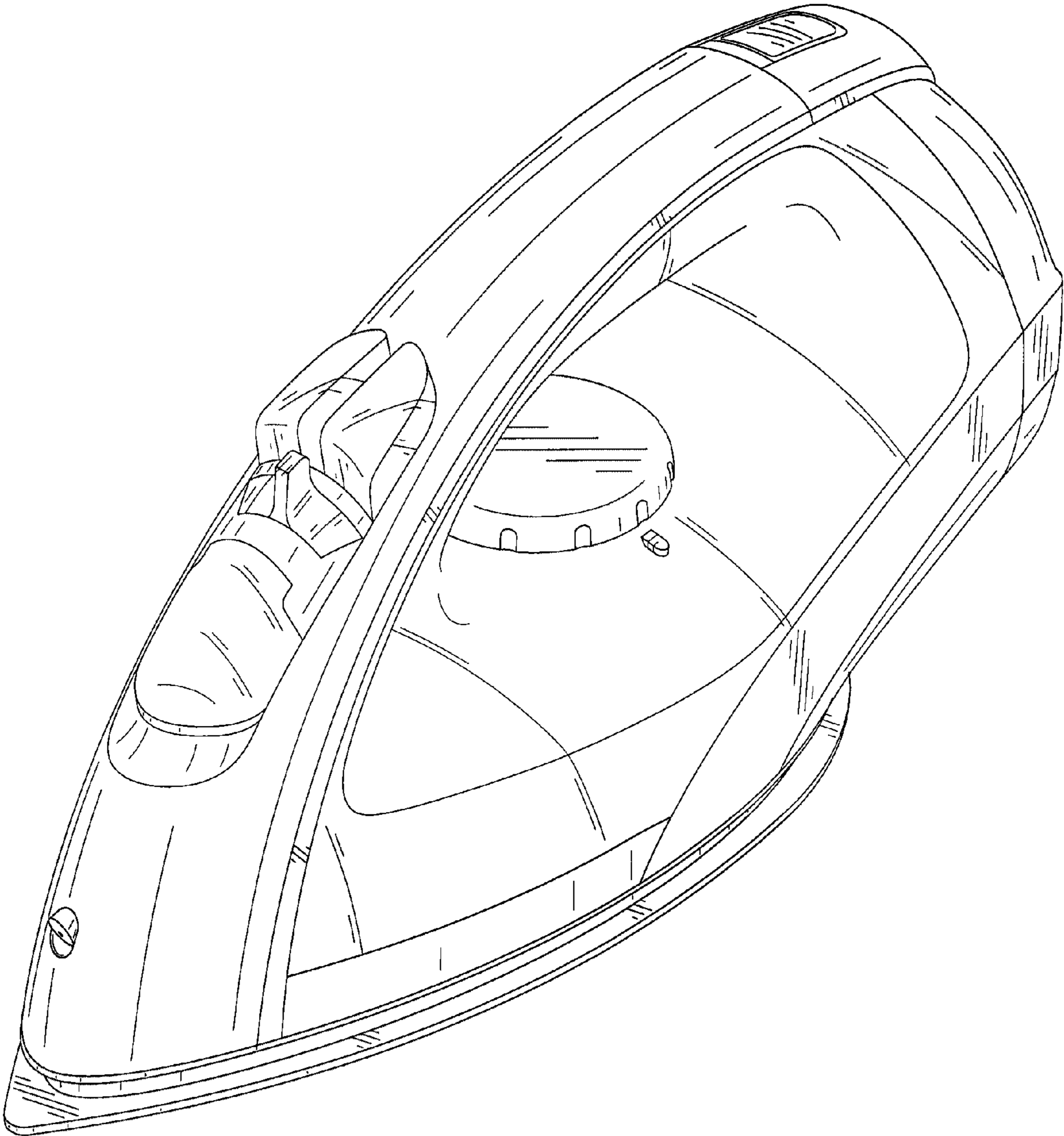

FIG.9

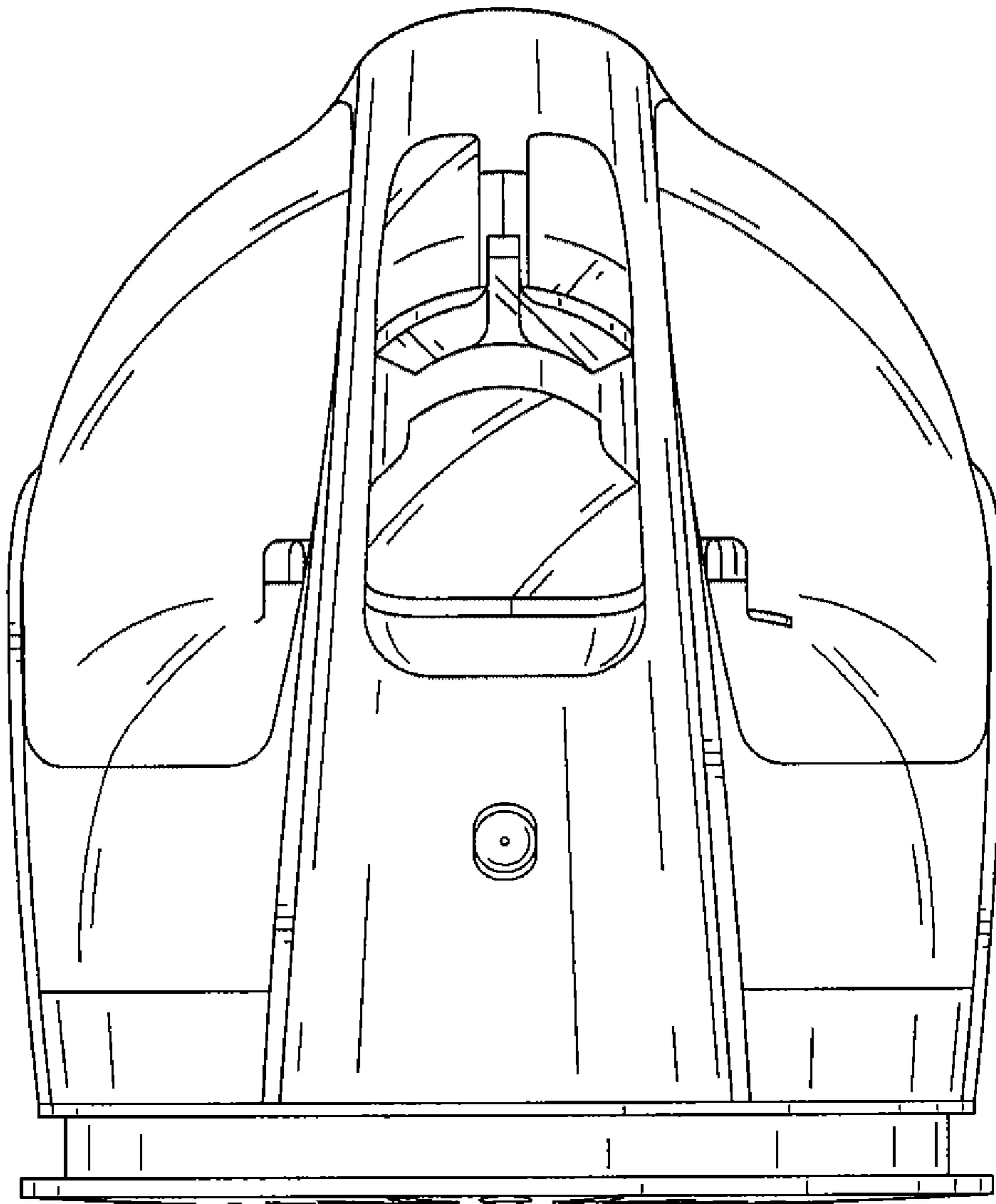

FIG. 10

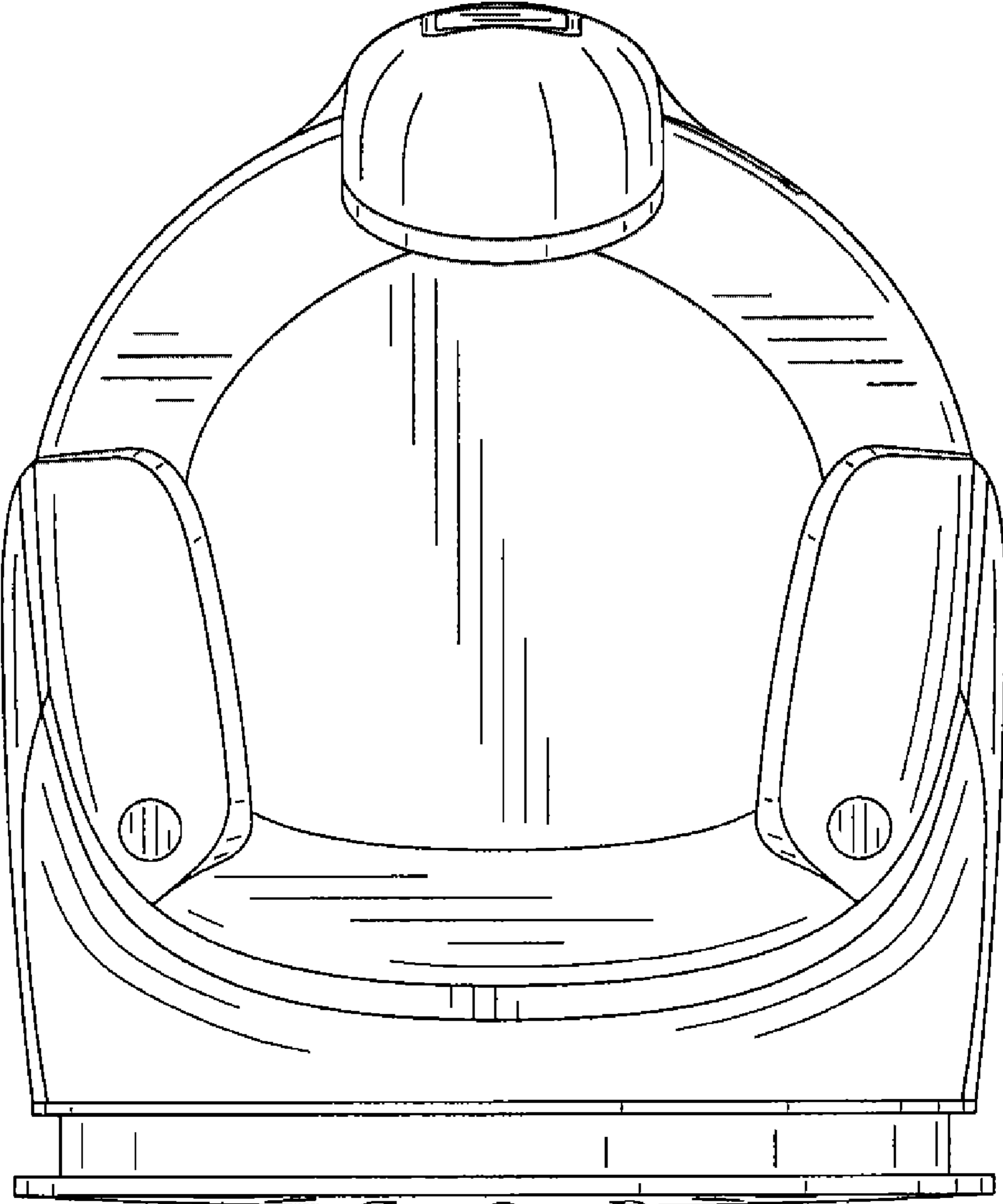

FIG.11

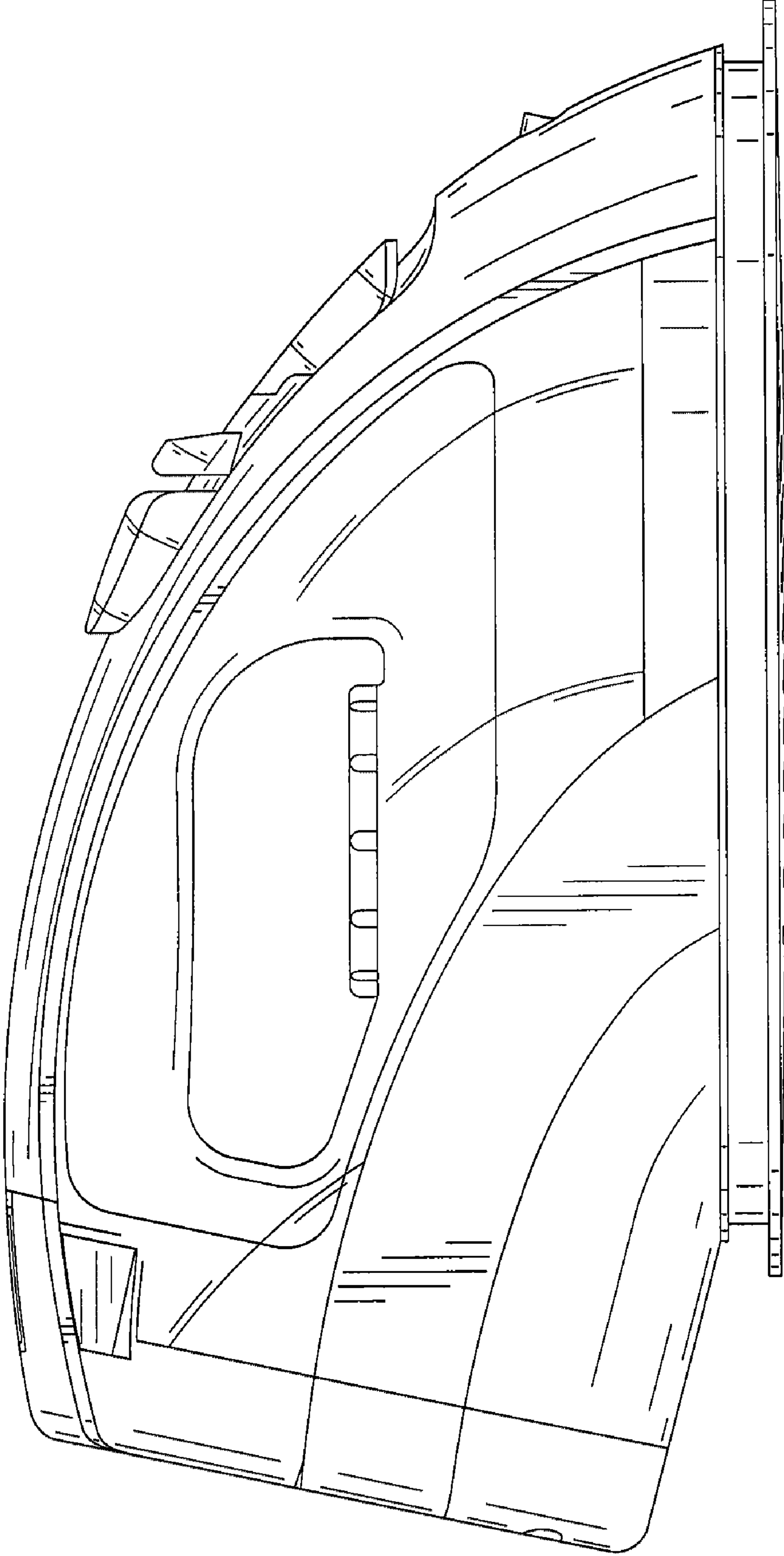

FIG.12

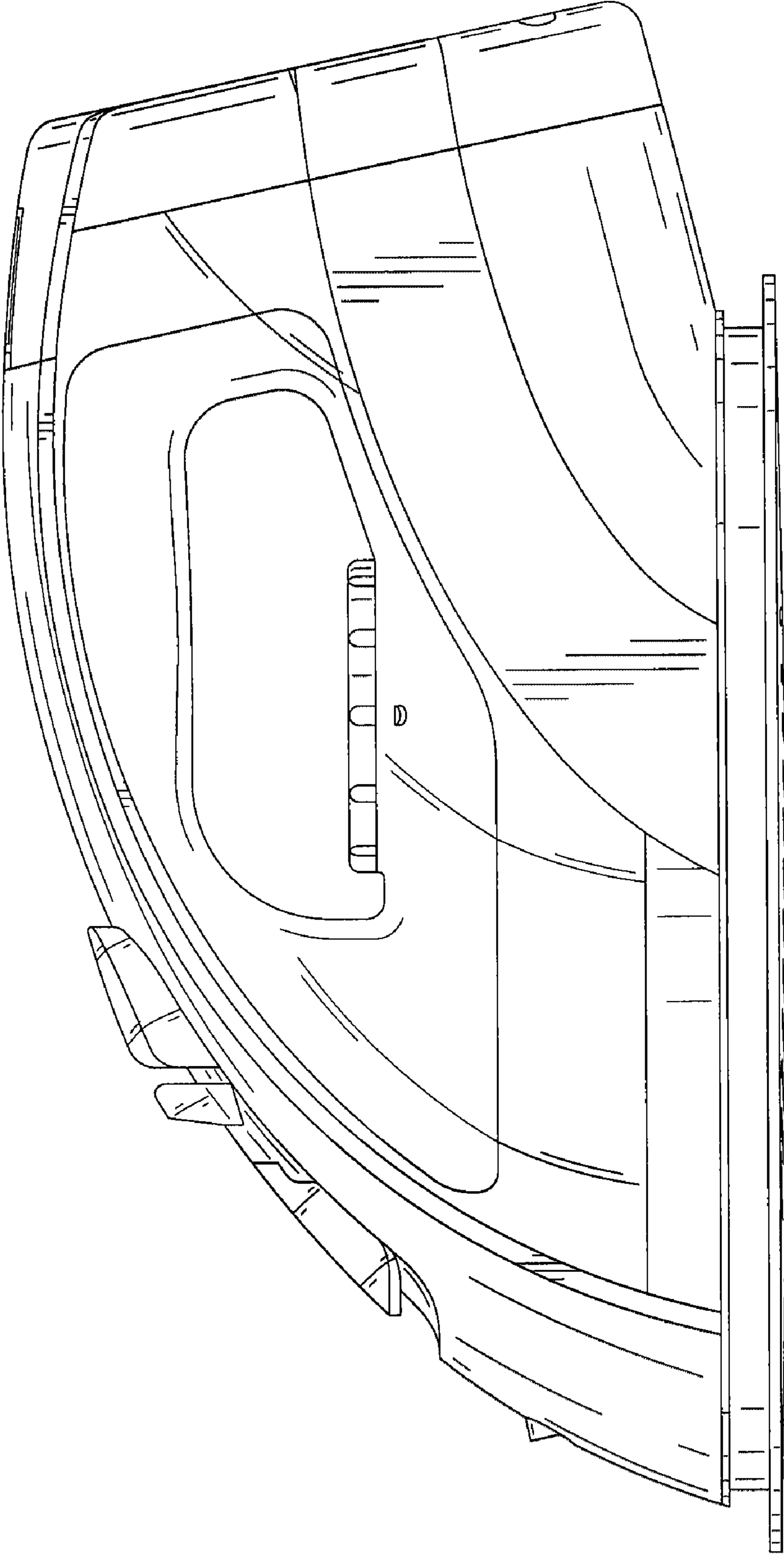

FIG.13

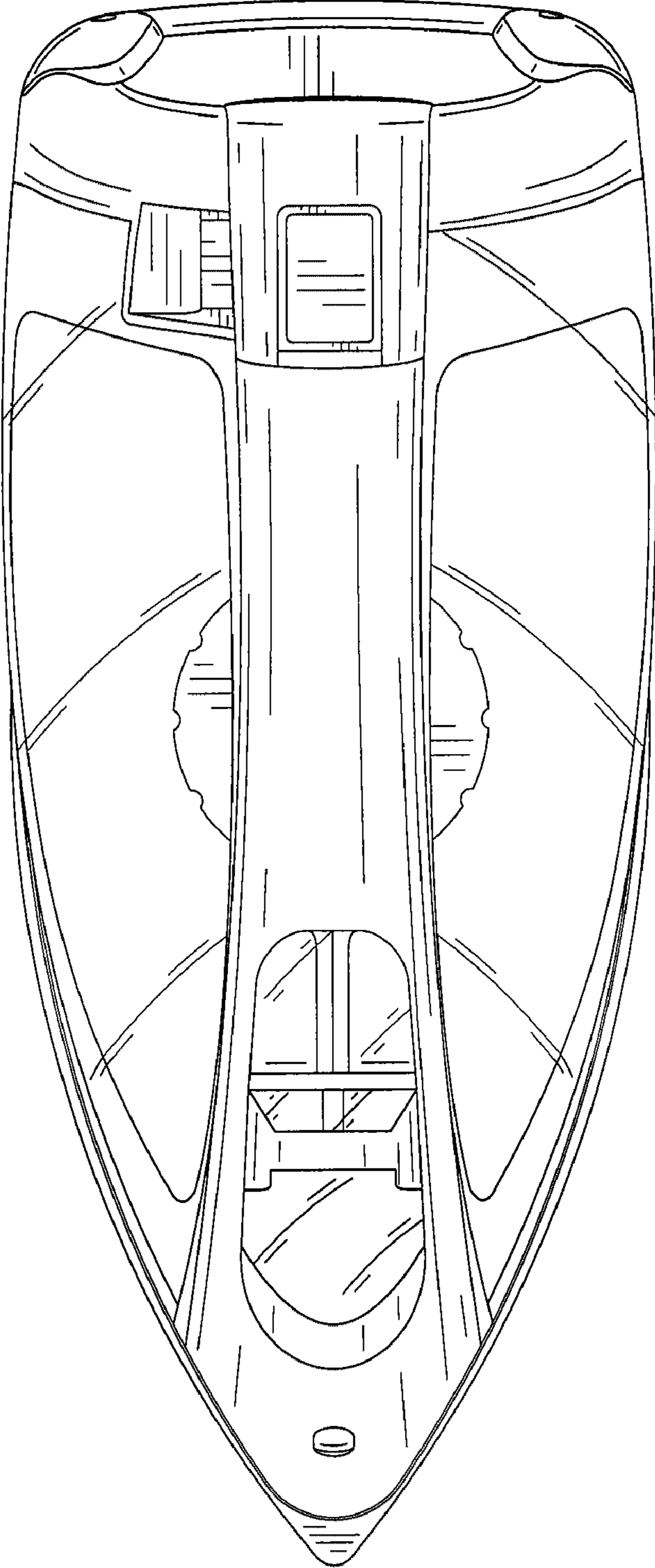

FIG. 14

