

US00D646805S

(12) **United States Design Patent**
Kim et al.

(10) **Patent No.:** **US D646,805 S**

(45) **Date of Patent:** **** Oct. 11, 2011**

(54) **LED LAMP**

(75) Inventors: **Taihong Kim**, Seoul (KR); **Jungjoo Yoo**, Seoul (KR); **Jaeseung Choi**, Seoul (KR); **Jongsun Jeon**, Seoul (KR); **Wonho Jin**, Seoul (KR)

(73) Assignee: **LG Electronics Inc.**, Seoul (KR)

(**) Term: **14 Years**

(21) Appl. No.: **29/382,232**

(22) Filed: **Dec. 30, 2010**

(30) **Foreign Application Priority Data**

Jul. 2, 2010 (KR) 30-2010-0029236

(51) **LOC (9) Cl.** **26-04**

(52) **U.S. Cl.** **D26/2**

(58) **Field of Classification Search** D26/1-4;
313/313, 315, 316, 317, 318, 493; 315/52,
315/53, 56, 57, 58

See application file for complete search history.

(56) **References Cited**

U.S. PATENT DOCUMENTS

D545,457 S * 6/2007 Chen D26/2
D584,428 S * 1/2009 Li et al. D26/2

D587,384 S * 2/2009 Wei D26/2
D592,766 S * 5/2009 Zhu et al. D26/2
D601,275 S * 9/2009 Ho et al. D26/2
D607,587 S * 1/2010 Ko D26/2
D610,275 S * 2/2010 Cho D26/2
D612,956 S * 3/2010 Moon D26/2
D613,433 S * 4/2010 Moon D26/2

* cited by examiner

Primary Examiner — Marcus Jackson

(74) *Attorney, Agent, or Firm* — Birch, Stewart, Kolasch & Birch, LLP

(57) **CLAIM**

The ornamental design for a LED lamp, as shown and described.

DESCRIPTION

FIG. 1 is a top, front, perspective view of a LED lamp showing our new design;
FIG. 2 is a front view thereof;
FIG. 3 is a rear view thereof;
FIG. 4 is a left side view thereof;
FIG. 5 is a right side view thereof;
FIG. 6 is a top view thereof;
FIG. 7 is a bottom view thereof; and,
FIG. 8 is a reference view thereof.

1 Claim, 8 Drawing Sheets

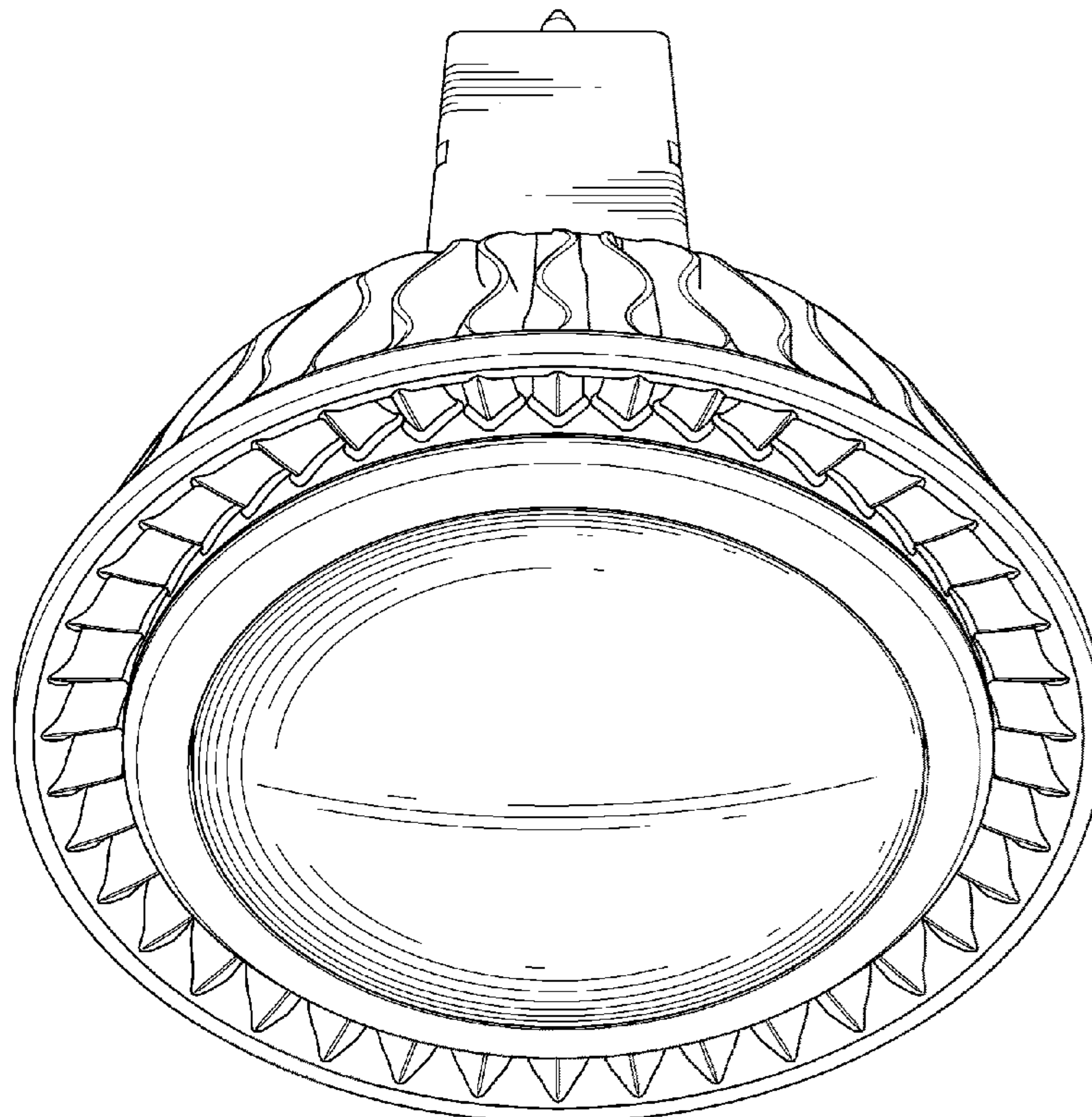

FIG. 1

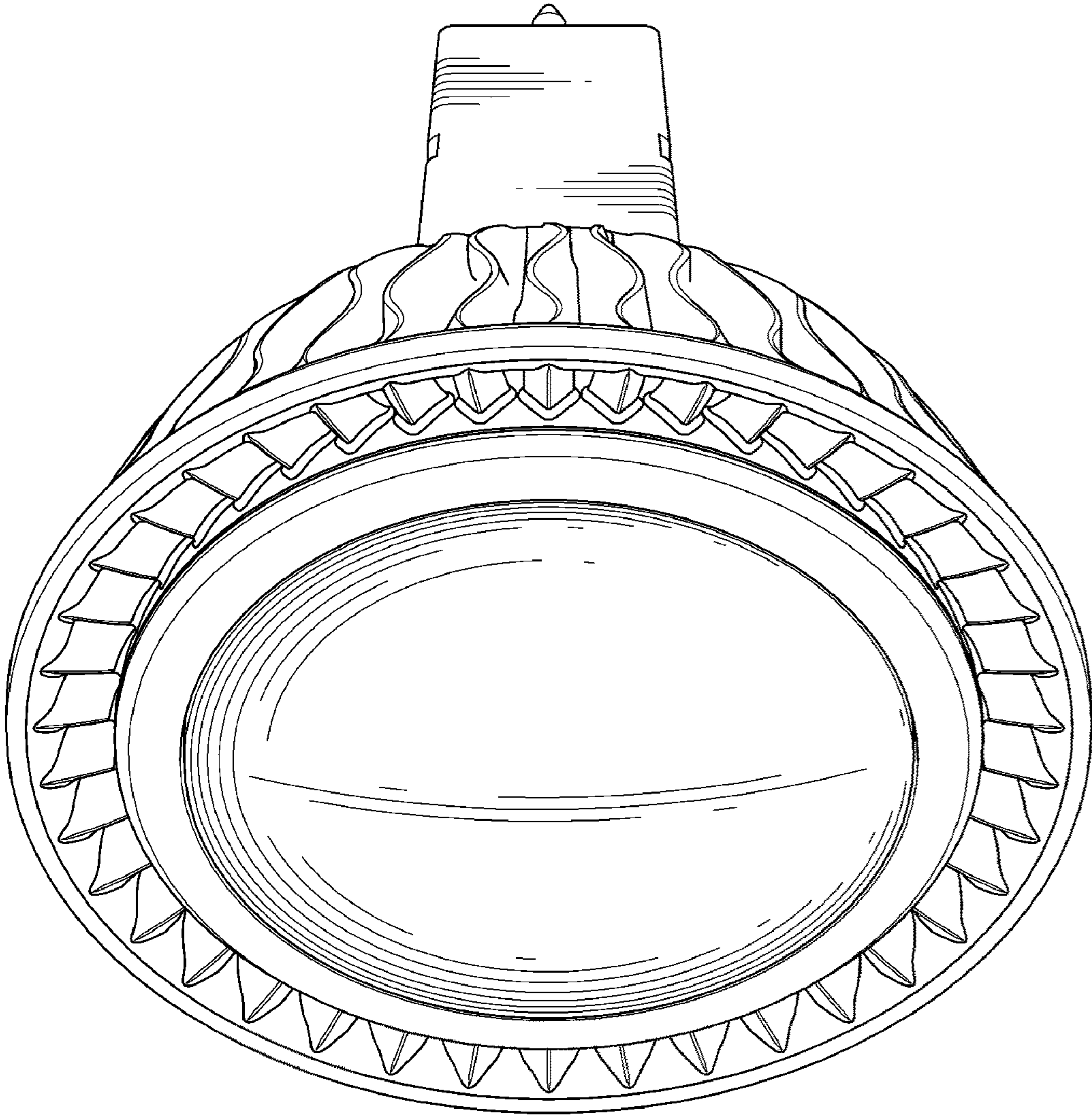

FIG. 2

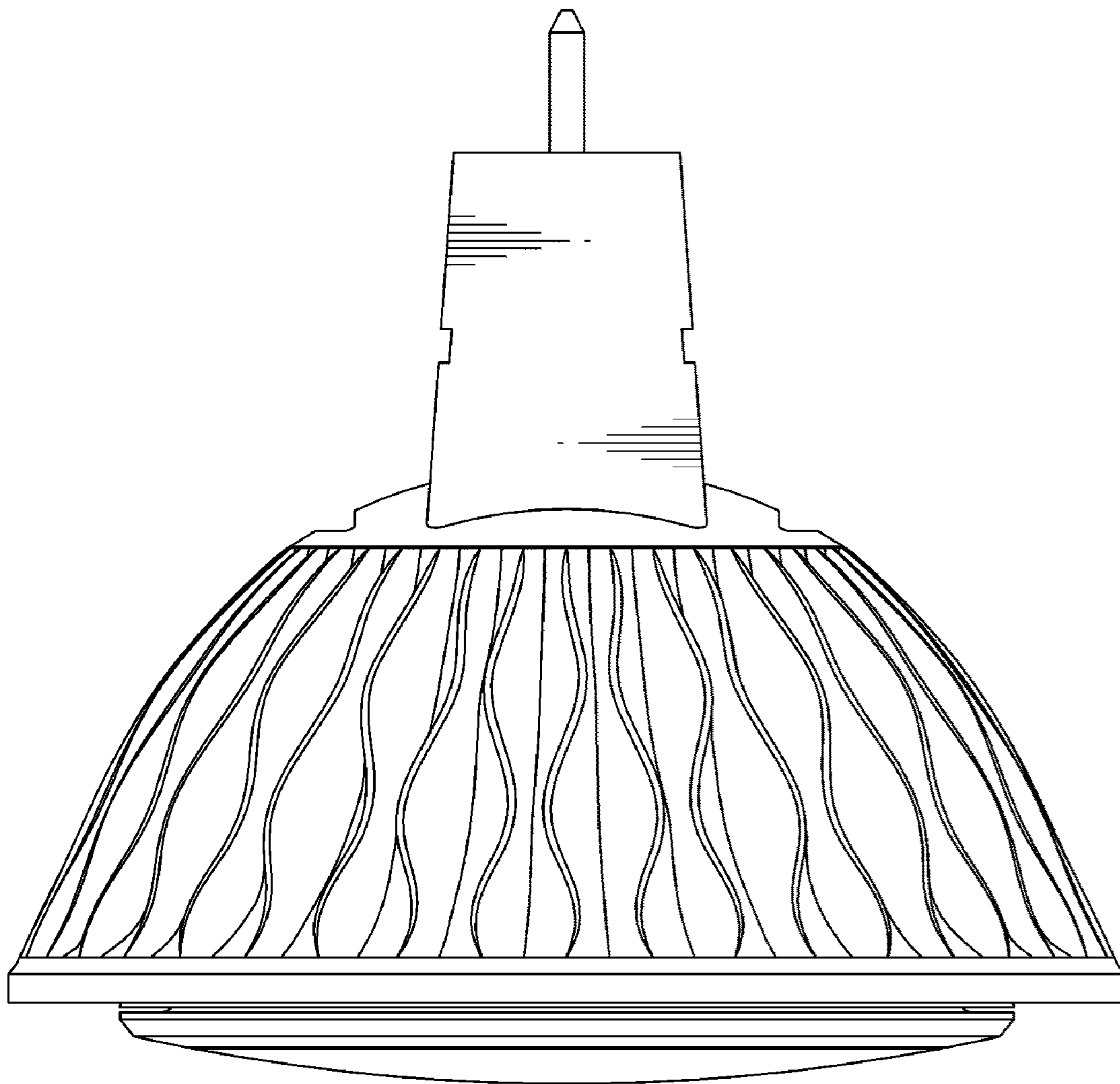

FIG. 3

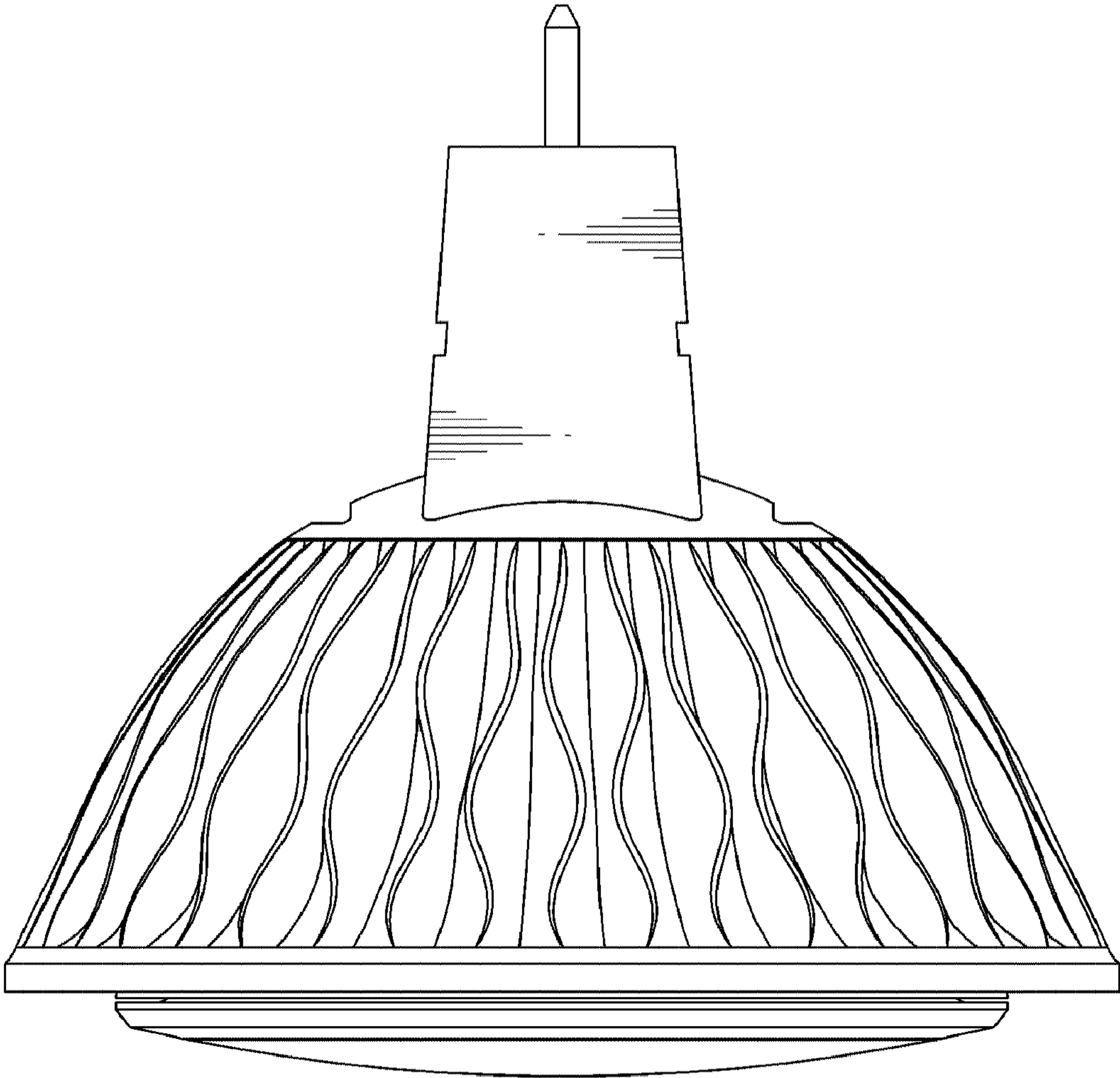

FIG. 4

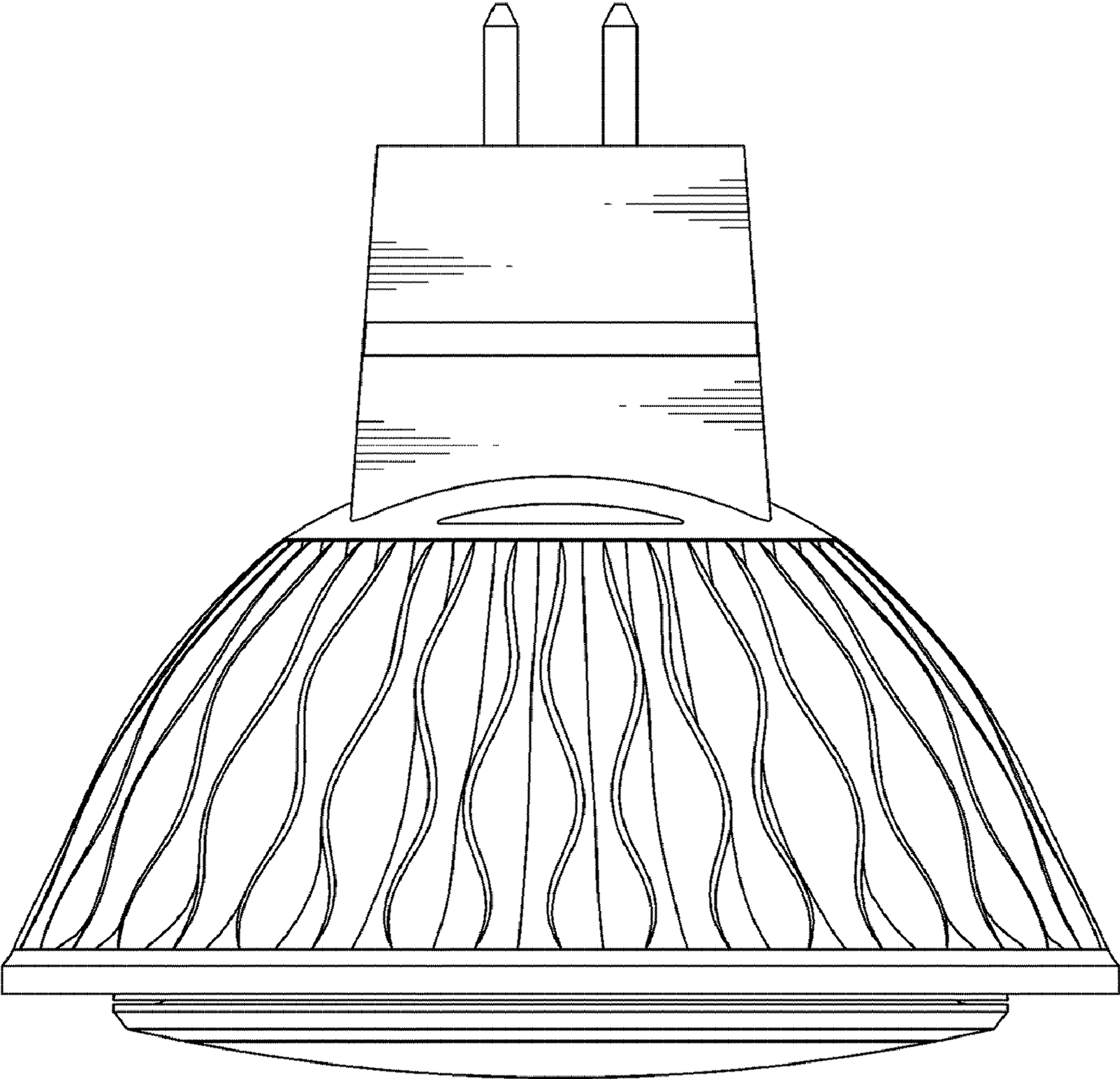

FIG. 5

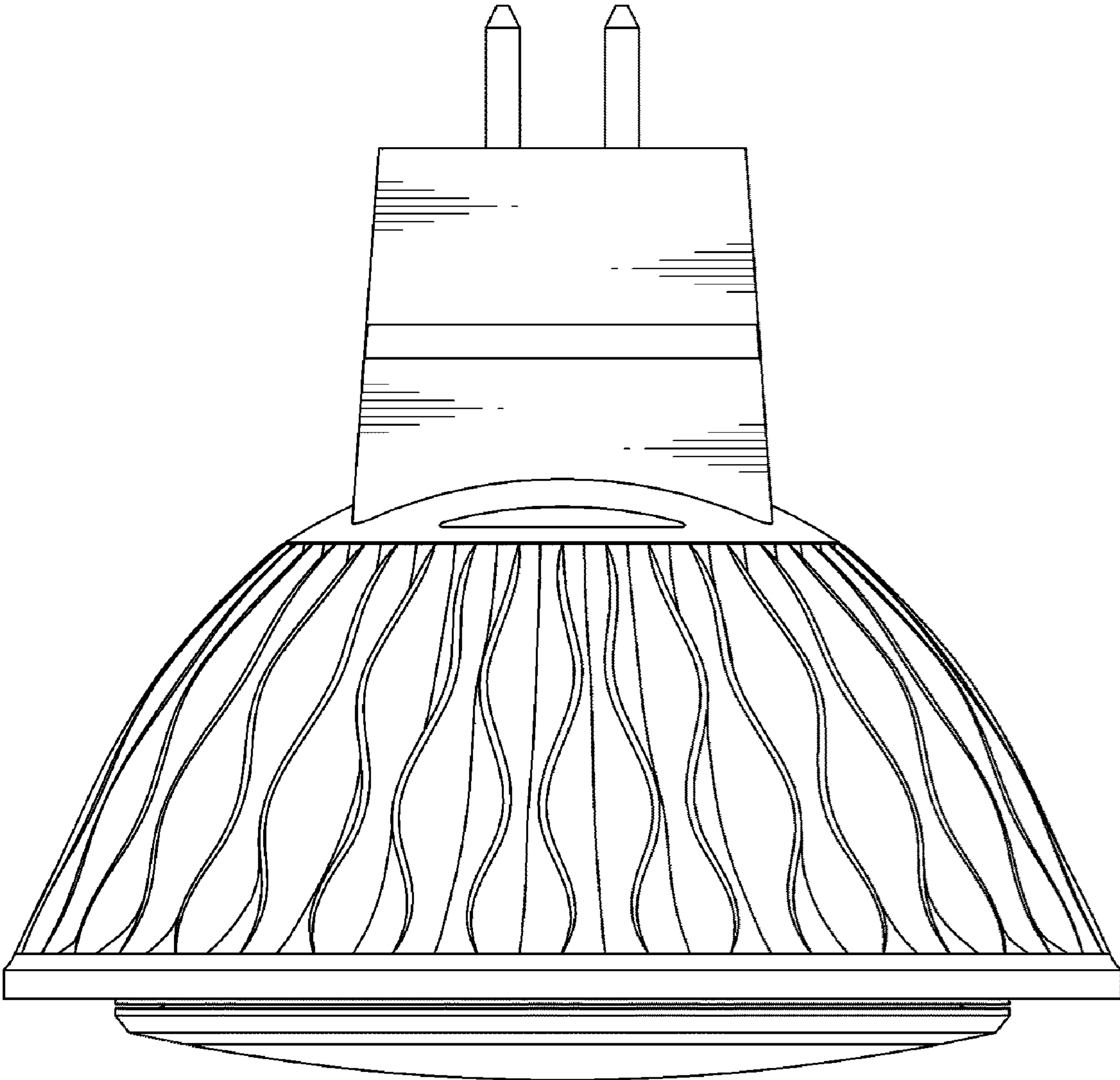

FIG. 6

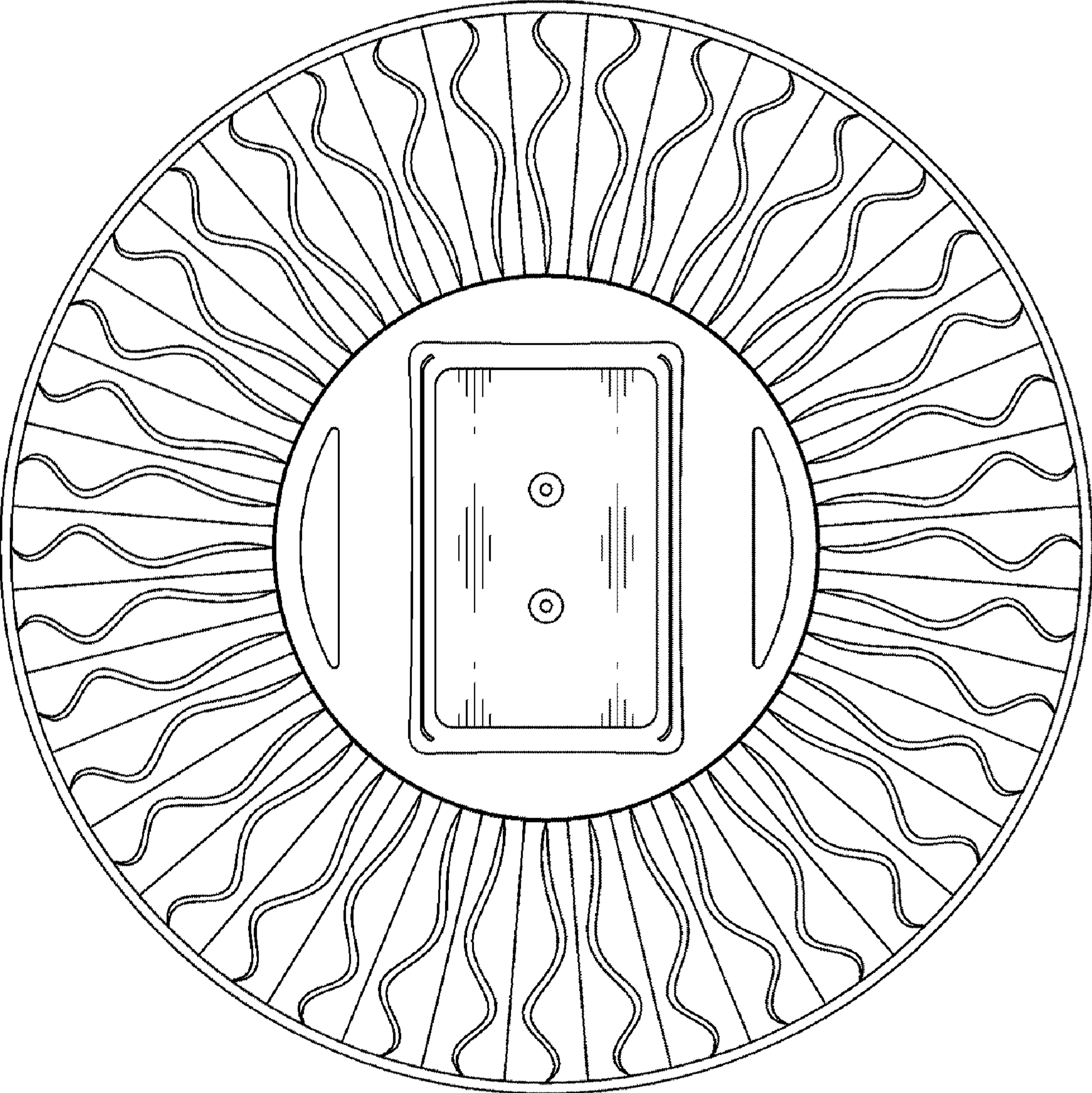

FIG. 7

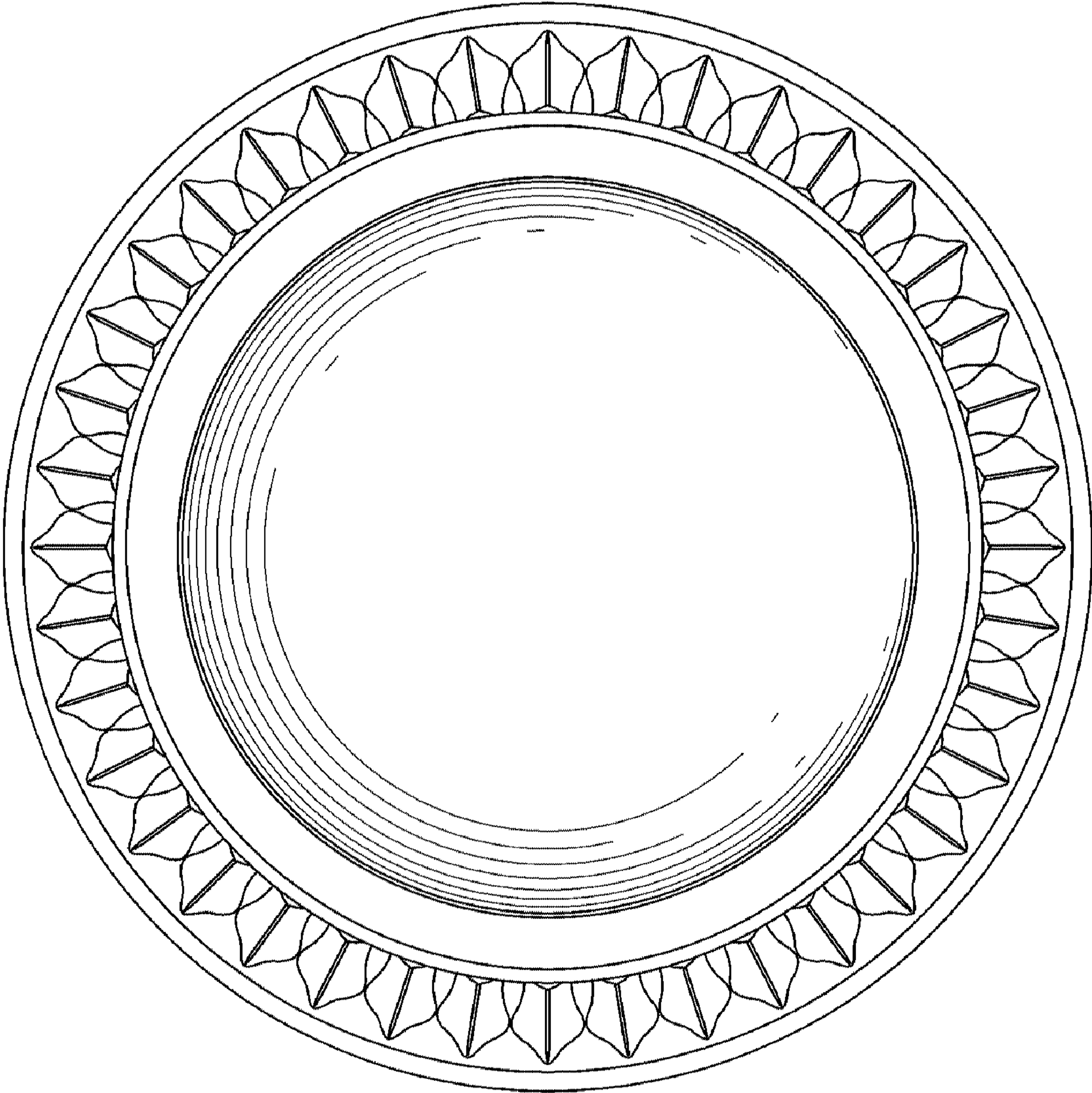

FIG. 8

