



US00D646670S

(12) **United States Design Patent**  
**Tyssø**

(10) **Patent No.:** **US D646,670 S**  
(45) **Date of Patent:** **\*\* Oct. 11, 2011**

(54) **CODEC**

(75) Inventor: **Jorunn Tyssø**, Oslo (NO)

(73) Assignee: **Tandberg Telecom AS**, Lysaker (NO)

(\*\*) Term: **14 Years**

(21) Appl. No.: **29/347,508**

(22) Filed: **Feb. 16, 2010**

(30) **Foreign Application Priority Data**

Aug. 14, 2009 (NO) ..... 20090413

(51) **LOC (9) Cl.** ..... **14-03**

(52) **U.S. Cl.** ..... **D14/250**

(58) **Field of Classification Search** ..... D14/250,  
D14/440, 496, 498, 500, 502, 505; 360/99.02,  
360/99.07; 369/75.11, 75.21, 77.11, 77.21;  
720/601, 612, 619, 647, 649, 655; 455/344,  
455/347-351; D3/201, 218, 269, 301, 273;  
D13/103; 220/4.02

See application file for complete search history.

(56) **References Cited**

U.S. PATENT DOCUMENTS

D620,497	S	*	7/2010	Hwang Bo et al.	.....	D14/505
D624,559	S	*	9/2010	Chung	.....	D14/502
D637,592	S	*	5/2011	Magness et al.	.....	D14/250
D638,005	S	*	5/2011	Richardson et al.	.....	D14/250
D638,412	S	*	5/2011	Lee	.....	D14/250
D639,307	S	*	6/2011	Lee et al.	.....	D14/500

\* cited by examiner

*Primary Examiner* — Susan Bennett Hattan

*Assistant Examiner* — Barbara B Lohr

(74) *Attorney, Agent, or Firm* — Oblon, Spivak,  
McClelland, Maier & Neustadt, L.L.P.

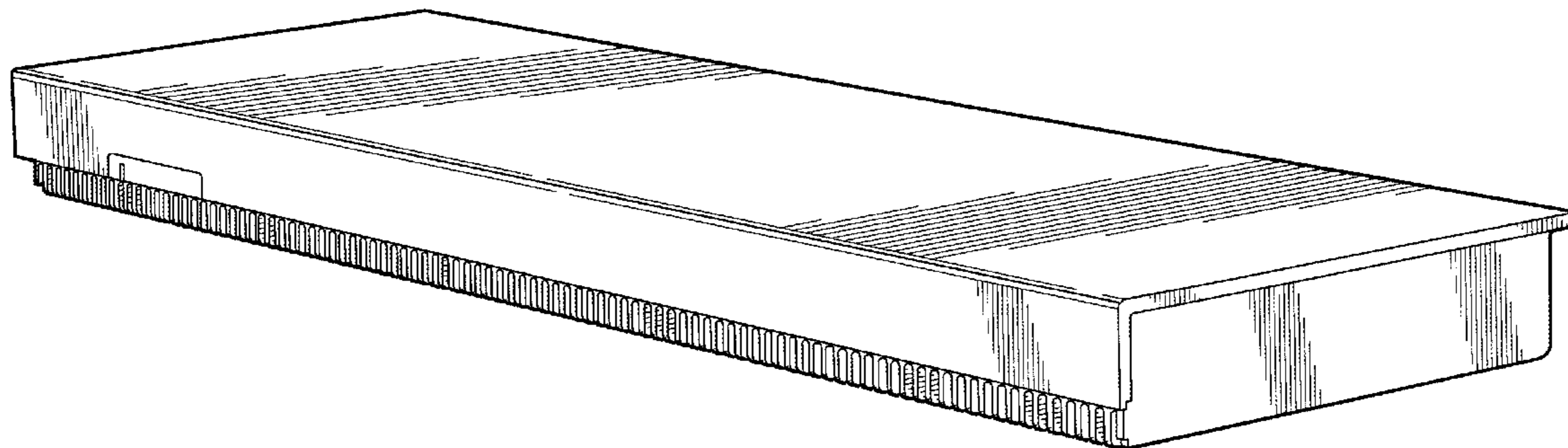
(57) **CLAIM**

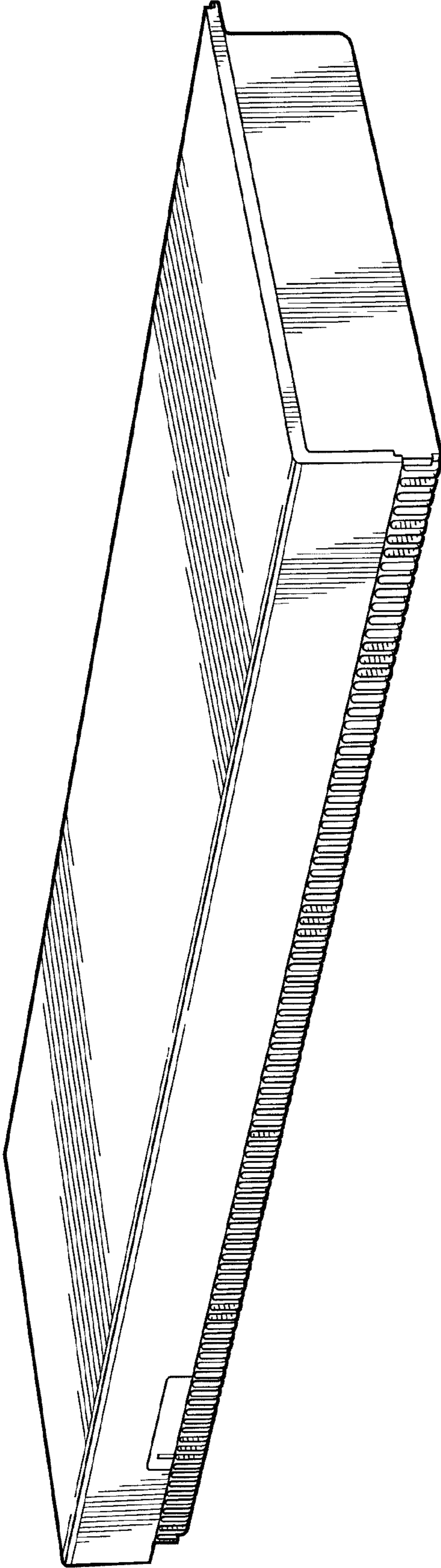
The ornamental design for a codec, as shown.

**DESCRIPTION**

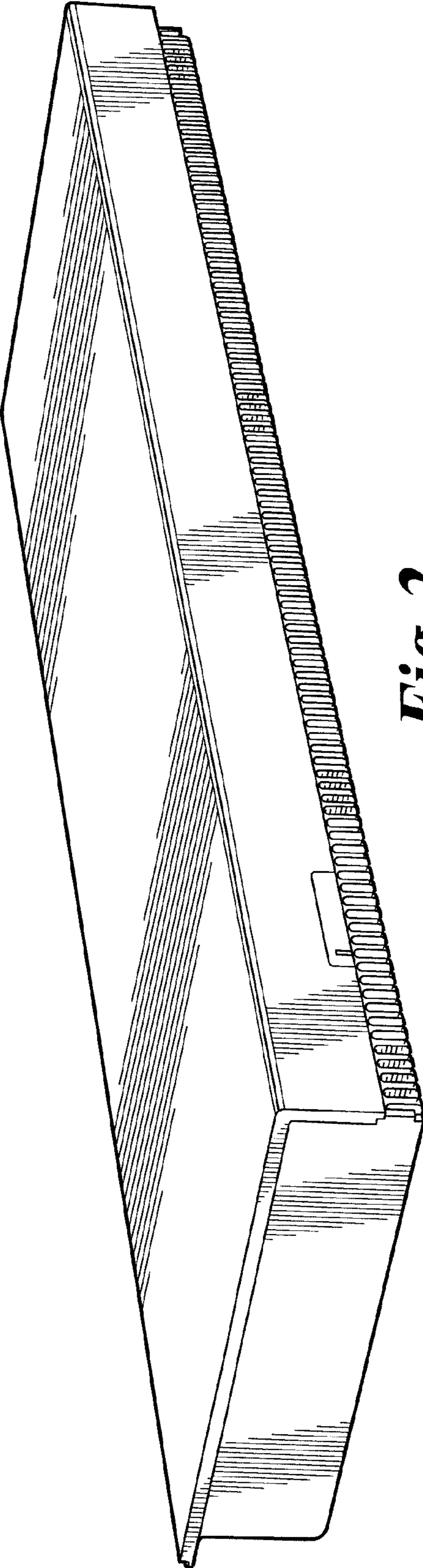
FIG. 1 is a front, top, and right side perspective view of a codec;  
FIG. 2 is a front, top, and left side perspective view thereof;  
FIG. 3 is a front elevational view thereof;  
FIG. 4 is a rear elevational view thereof;  
FIG. 5 is a bottom plan view thereof;  
FIG. 6 is a top plan view thereof;  
FIG. 7 is a left side elevational view thereof; and,  
FIG. 8 is a right side elevational view thereof.

**1 Claim, 6 Drawing Sheets**

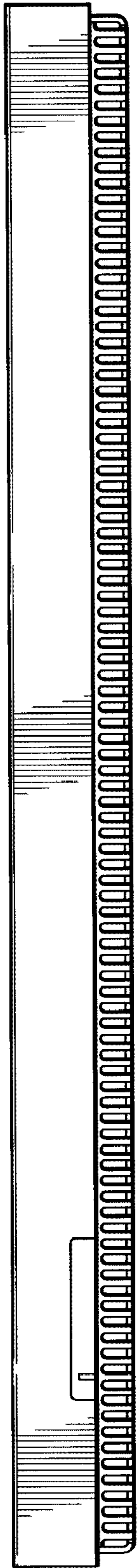




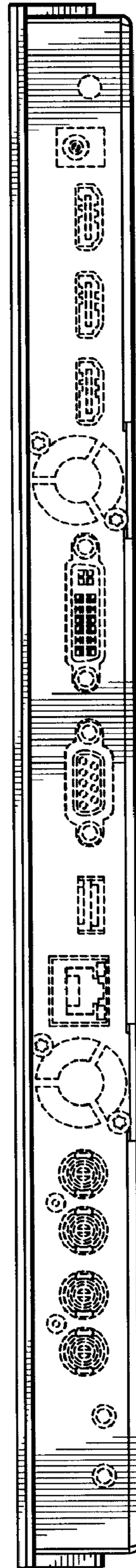
*Fig. 1*



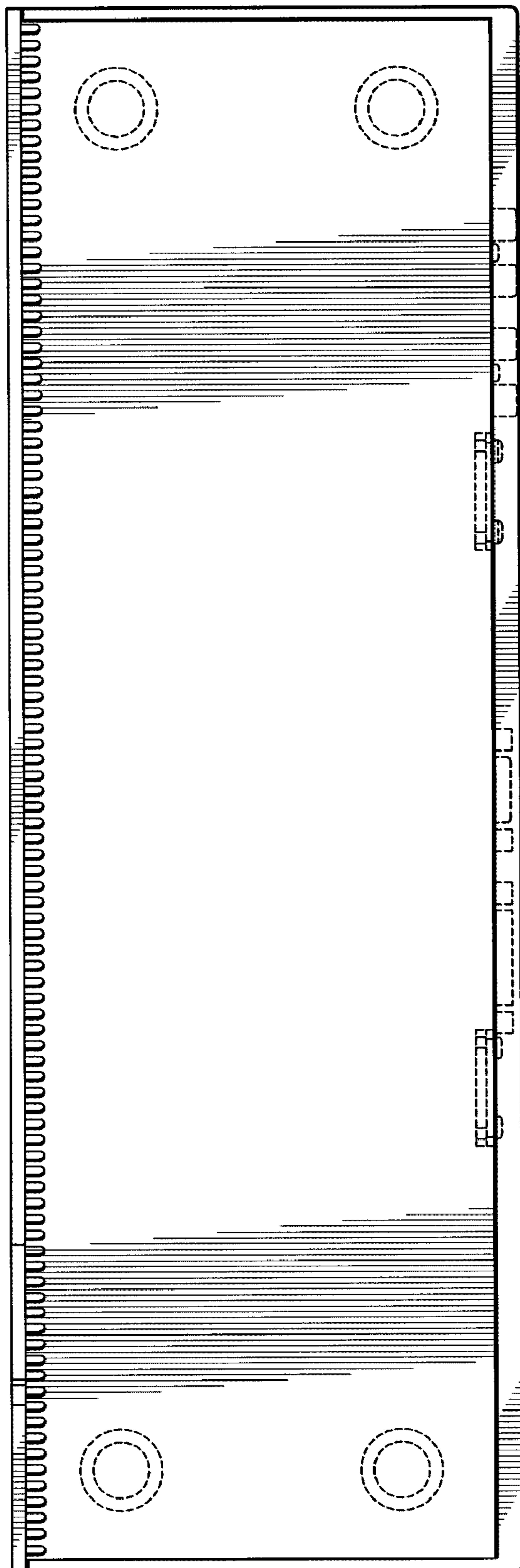
*Fig. 2*



*Fig. 3*

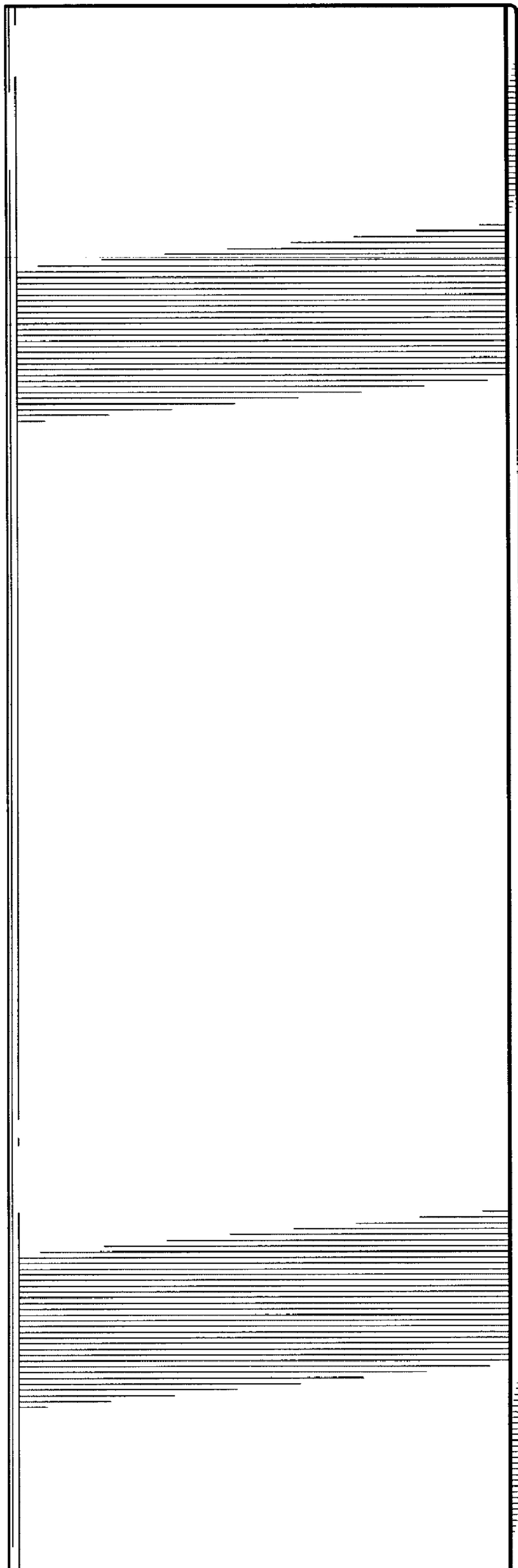


*Fig. 4*

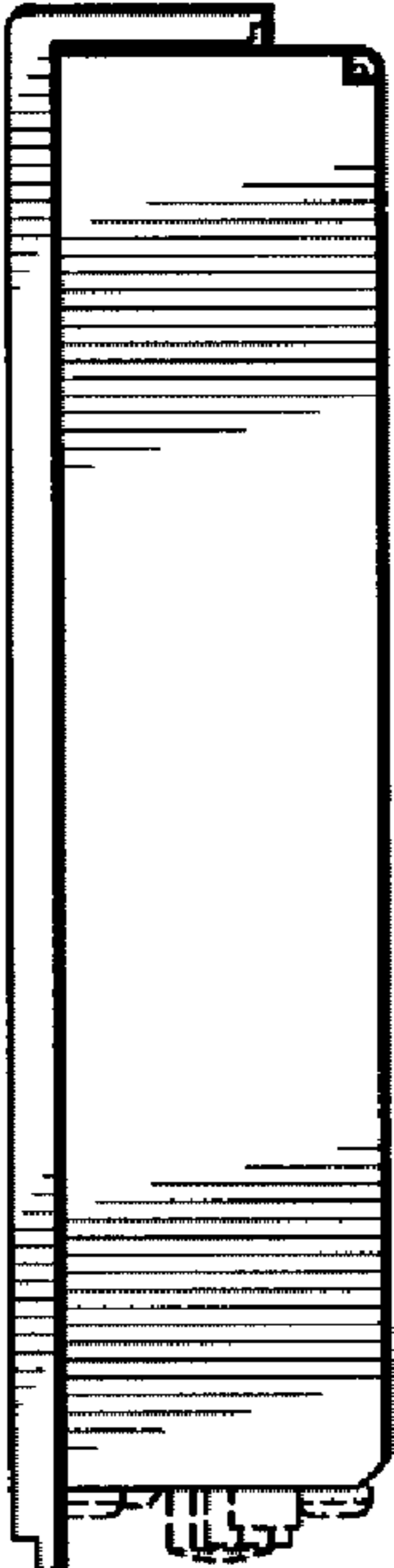


*Fig. 5*

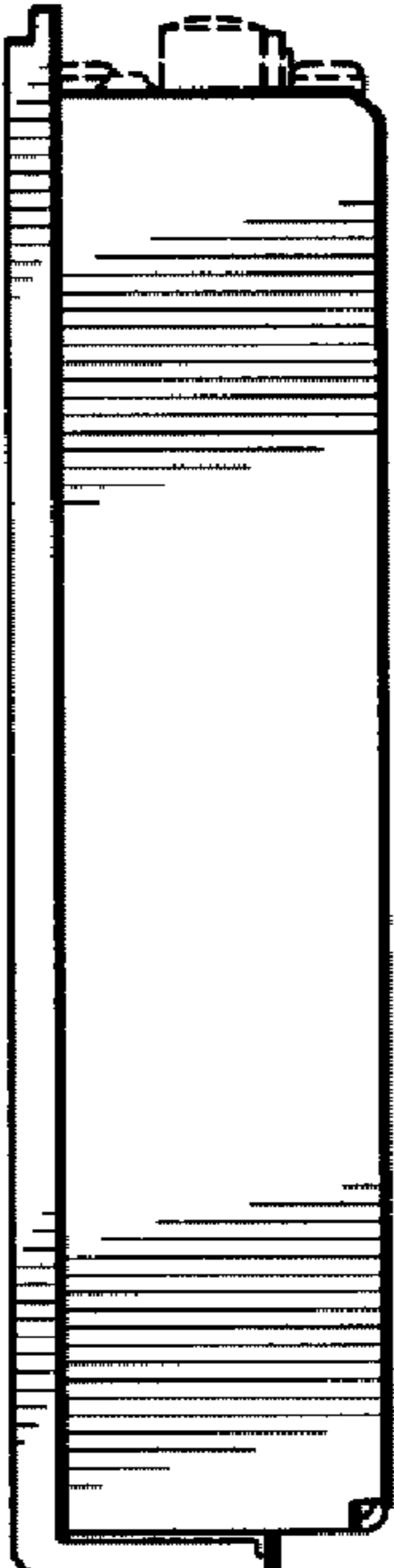




*Fig. 6*



*Fig. 7*



*Fig. 8*