



US00D646586S

(12) **United States Design Patent**
Nottingham

(10) **Patent No.:** **US D646,586 S**

(45) **Date of Patent:** **** Oct. 11, 2011**

(54) **SAFETY RAZOR CASE**

(75) Inventor: **John W. Nottingham**, Bratenahl, OH
(US)

(73) Assignee: **Avery Dennison Corporation**,
Pasadena, CA (US)

(**) Term: **14 Years**

(21) Appl. No.: **29/383,629**

(22) Filed: **Jan. 20, 2011**

(51) **LOC (9) Cl.** **09-03**

(52) **U.S. Cl.** **D9/748**

(58) **Field of Classification Search** D9/749,

D9/337, 748, 415; D6/526, 512; D3/201,
D3/205; 206/349, 228, 244, 252, 775, 208,
206/493, 354-360, 352; 30/514

See application file for complete search history.

(56) **References Cited**

U.S. PATENT DOCUMENTS

2,822,916	A *	2/1958	Wark et al.	206/228
2,925,905	A *	2/1960	Metzler et al.	206/228
2,984,380	A *	5/1961	Leopold et al.	220/827
D226,804	S *	5/1973	Leathers	D9/748
D227,080	S *	6/1973	Poisson	D9/748
D227,232	S *	6/1973	Glaberson et al.	D9/748
D228,629	S *	10/1973	Glaberson	D9/748
D228,745	S *	10/1973	Glaberson et al.	D9/748
D236,437	S *	8/1975	Leathers	D9/748
6,415,517	B1 *	7/2002	Worrick, III	30/541

D534,815	S *	1/2007	White	D9/749
D542,675	S *	5/2007	Luxton et al.	D9/749
D546,199	S *	7/2007	Gray et al.	D9/749
D572,150	S *	7/2008	Stowers et al.	D9/749
D596,953	S *	7/2009	Wonderley et al.	D9/749
7,858,027	B2 *	12/2010	Trissel	422/7

* cited by examiner

Primary Examiner — Mark Goodwin

(57) **CLAIM**

The ornamental design for a safety razor case, as shown and described.

DESCRIPTION

FIG. 1 is a perspective view of a safety razor case showing my new design;

FIG. 2 is a front elevation view of the safety razor case shown in FIG. 1;

FIG. 3 is a rear elevation view of the safety razor case shown in FIG. 1;

FIG. 4 is a left side elevation view of the safety razor case shown in FIG. 1;

FIG. 5 is a right side elevation view of the safety razor case shown in FIG. 1;

FIG. 6 is a top plan view of the safety razor case shown in FIG. 1; and,

FIG. 7 is a bottom plan view of the safety razor case shown in FIG. 1.

1 Claim, 7 Drawing Sheets

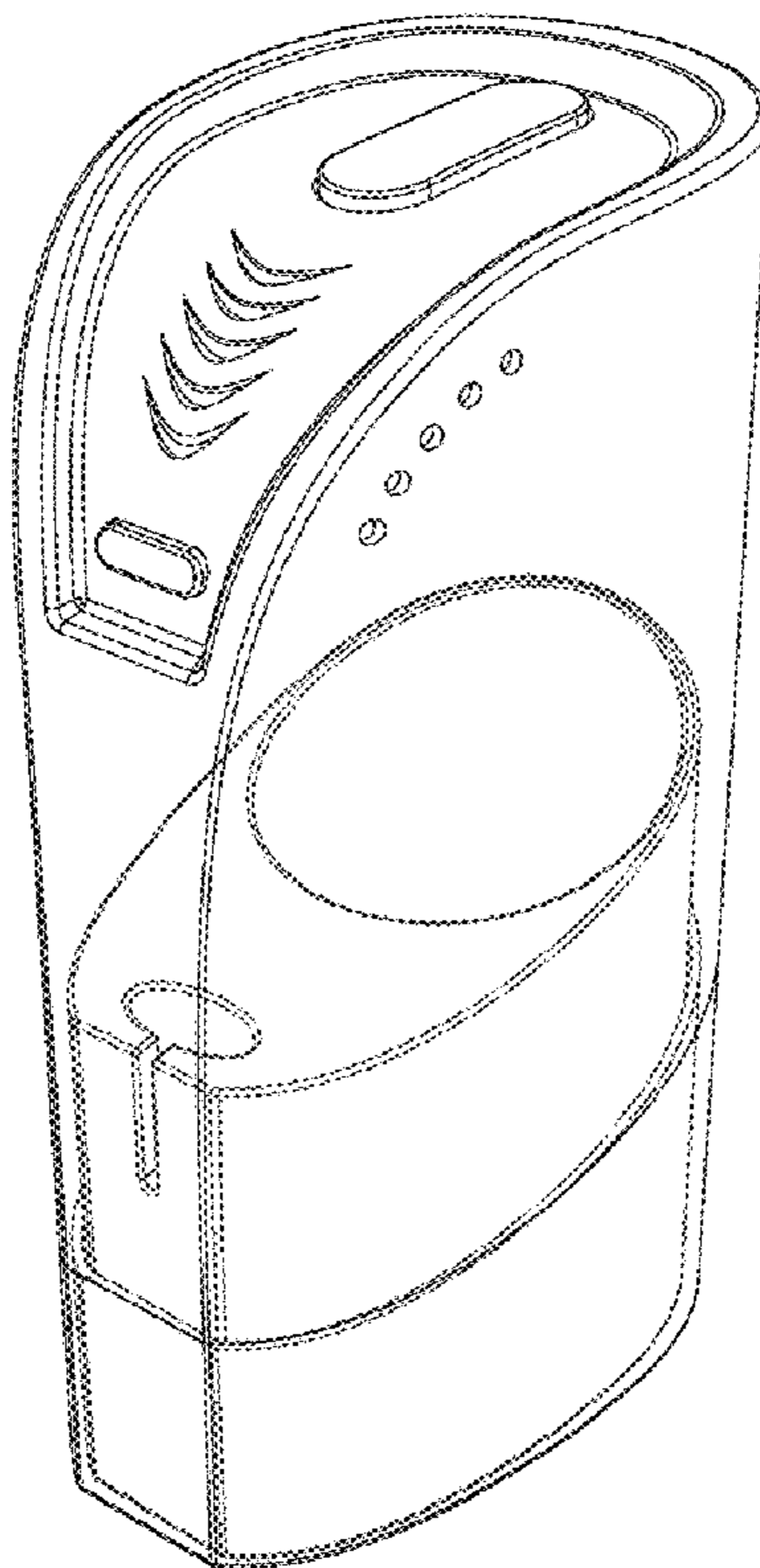

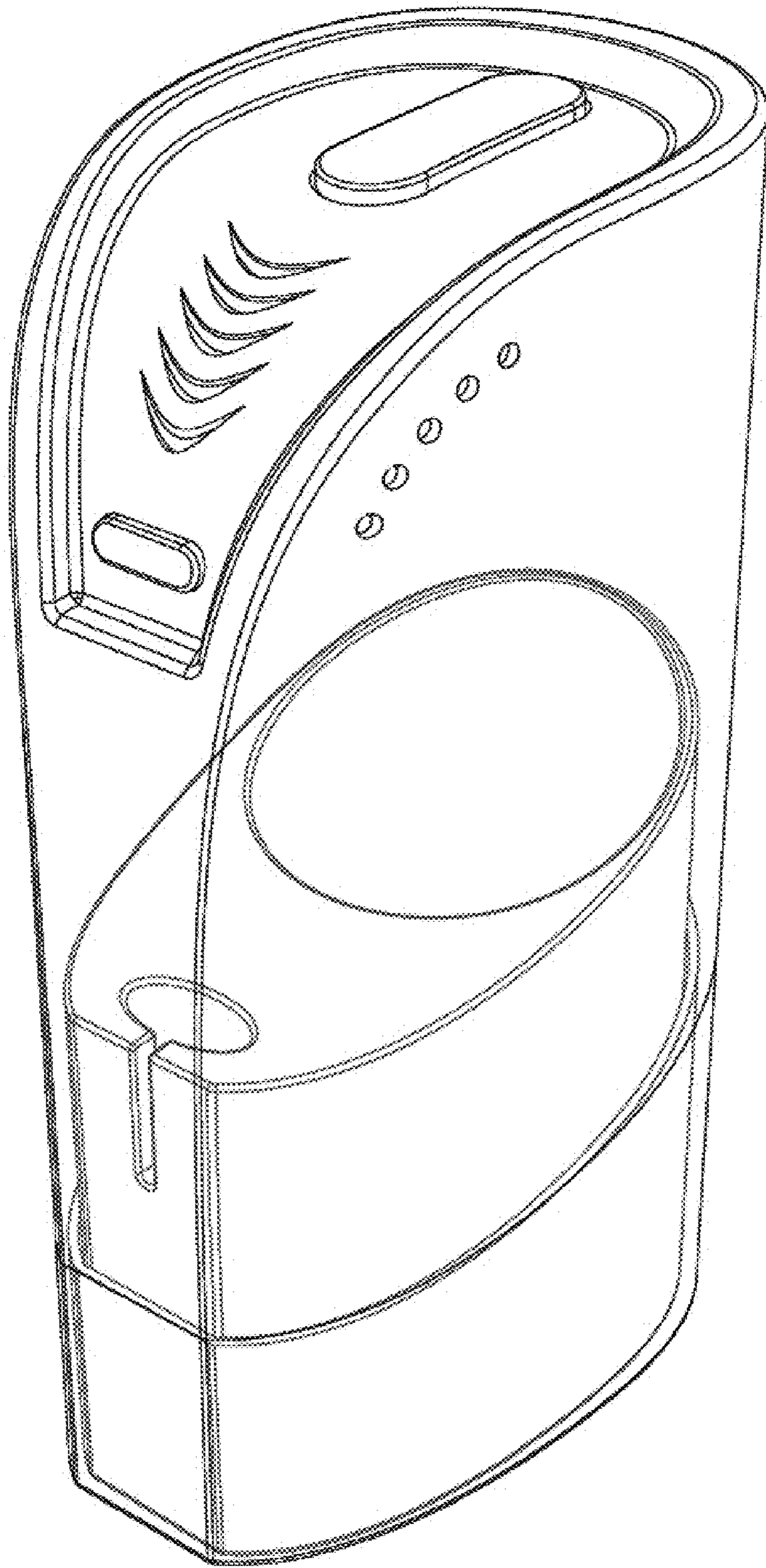

FIG. 1

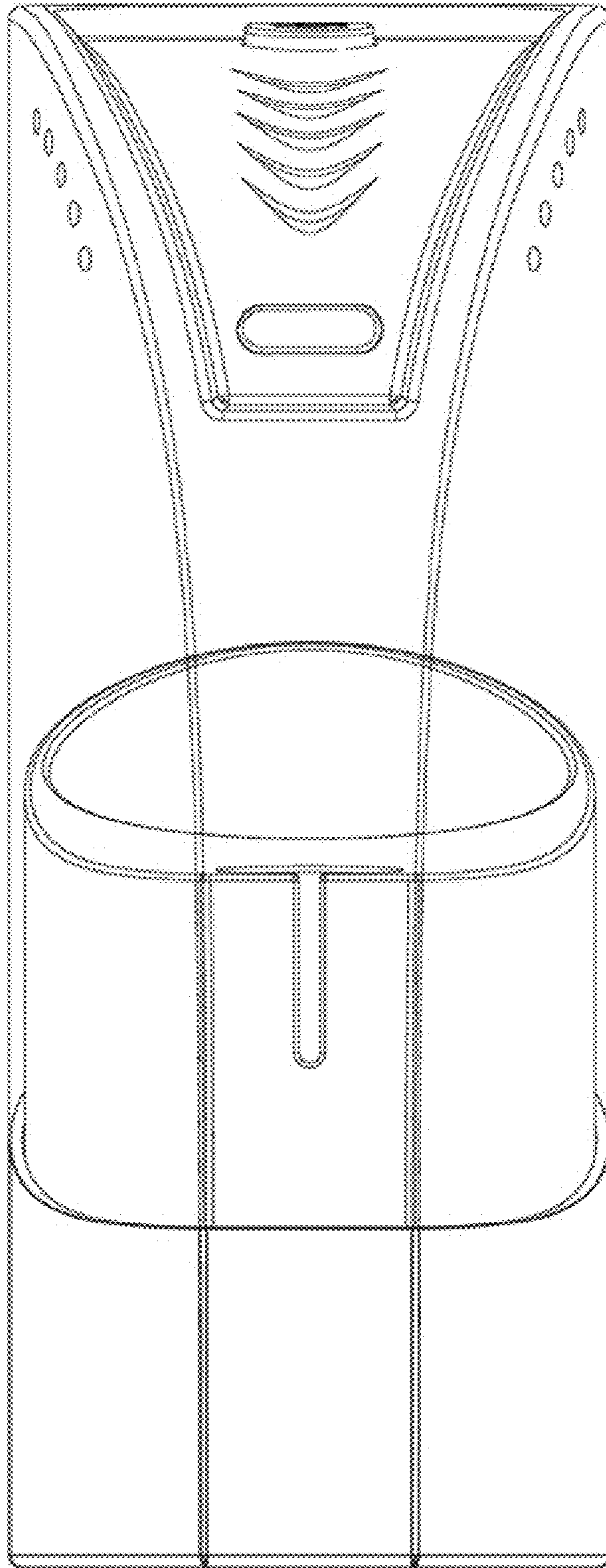

FIG. 2

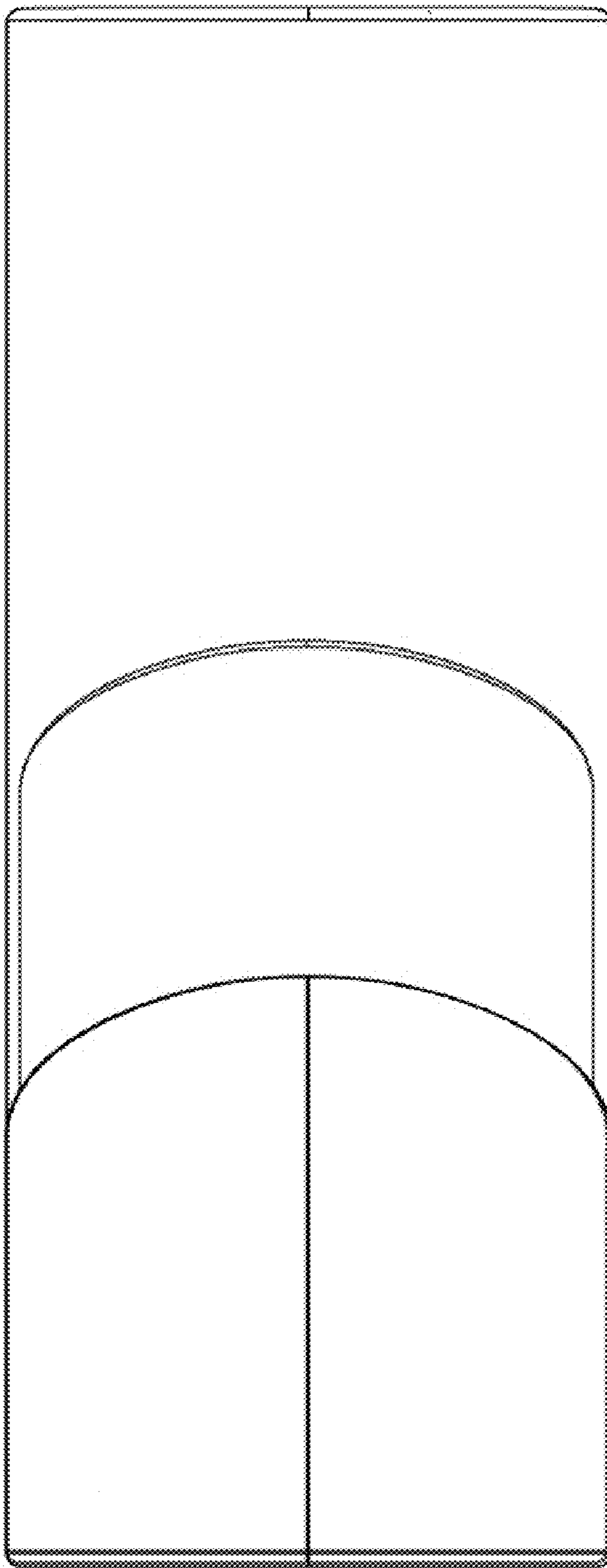

FIG. 3

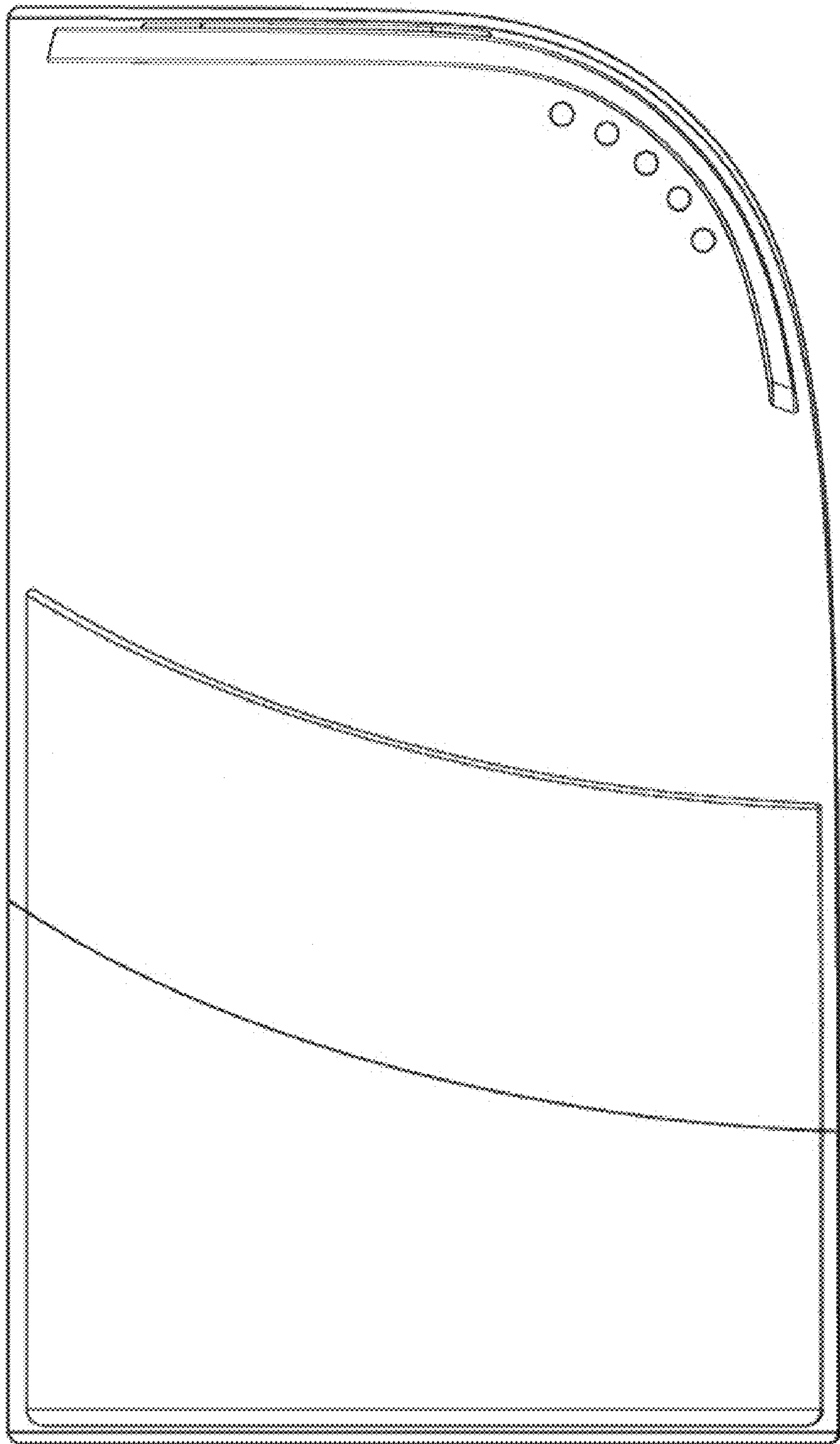

FIG. 4

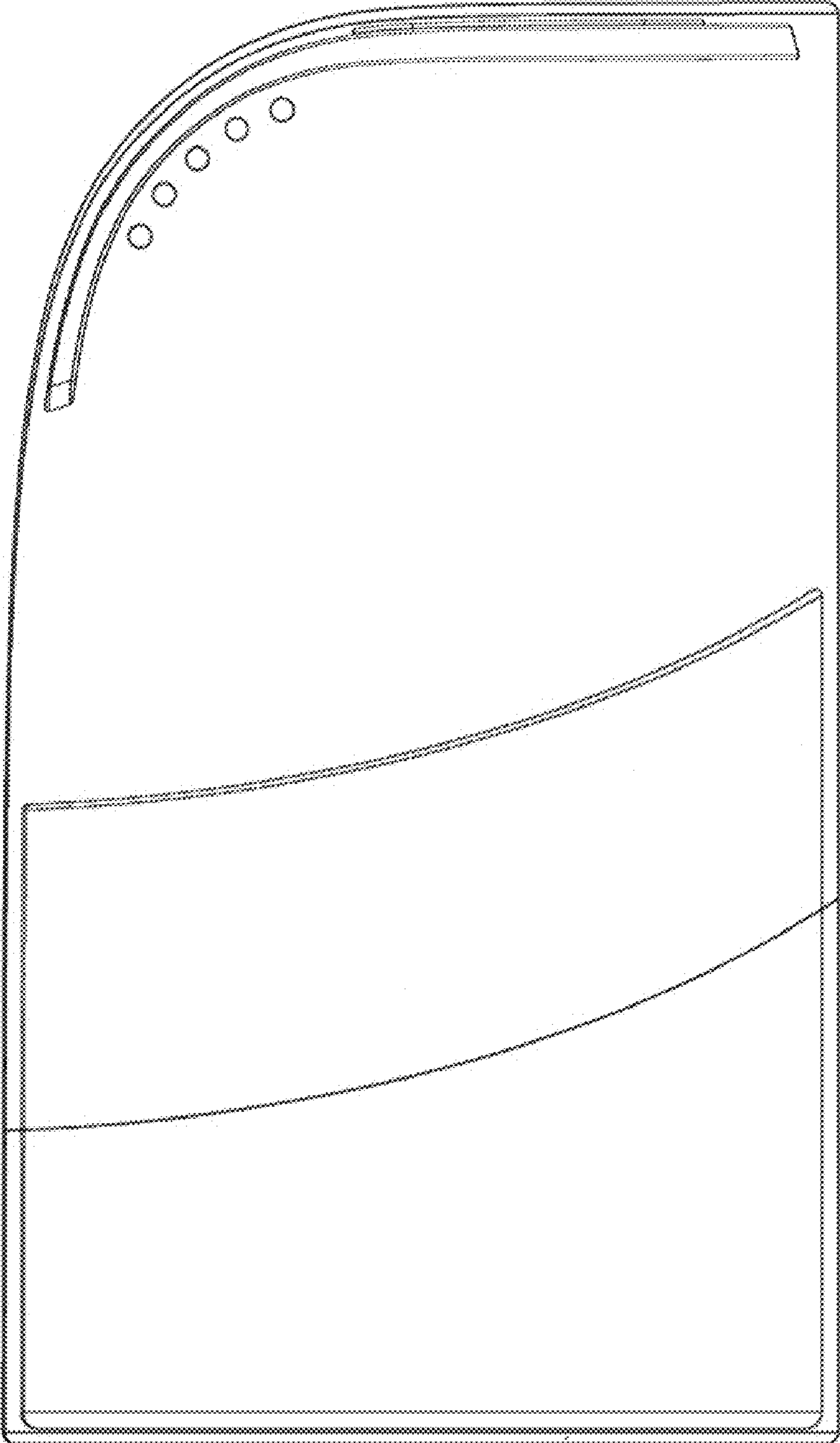

FIG. 5

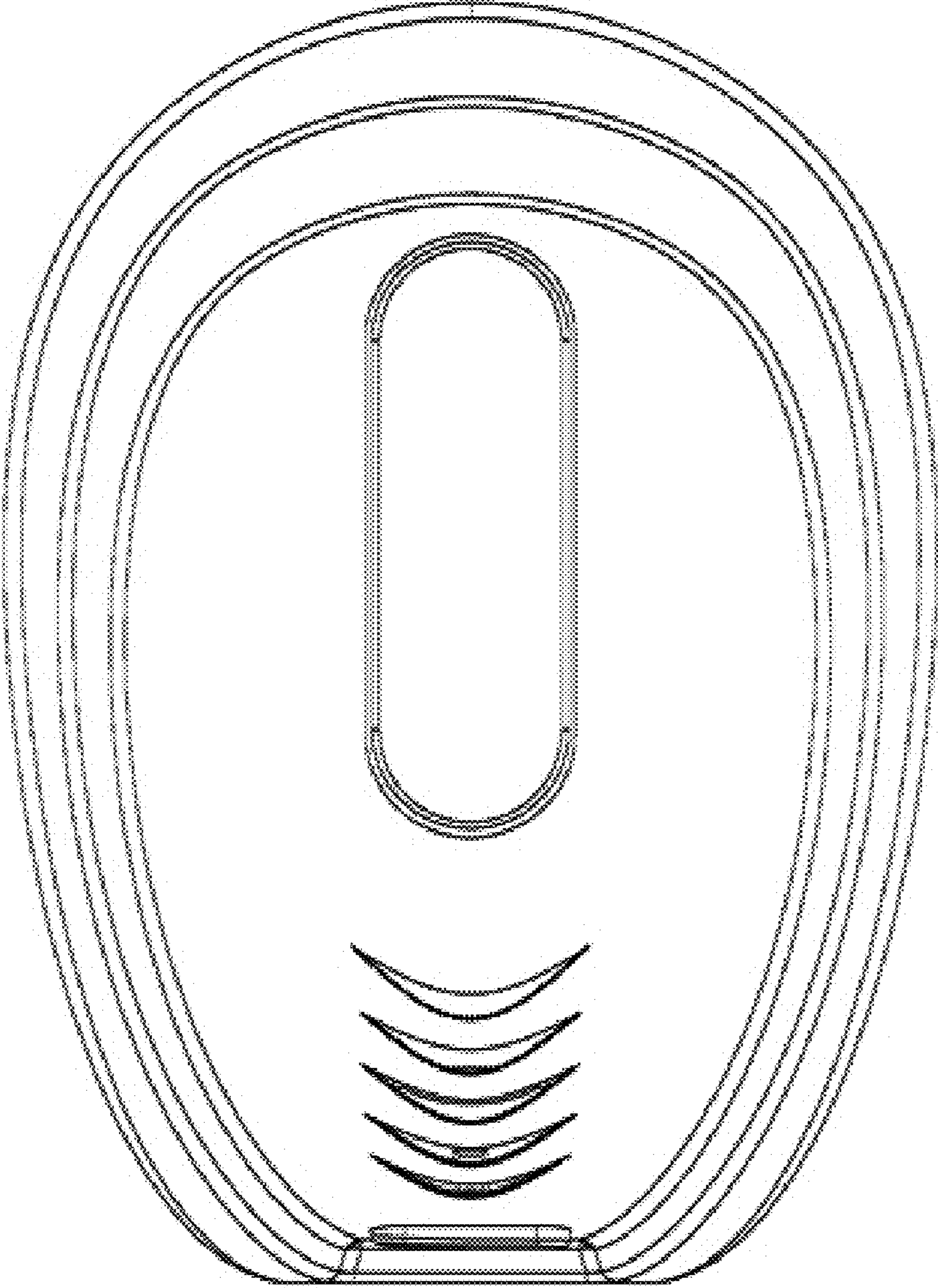

FIG. 6

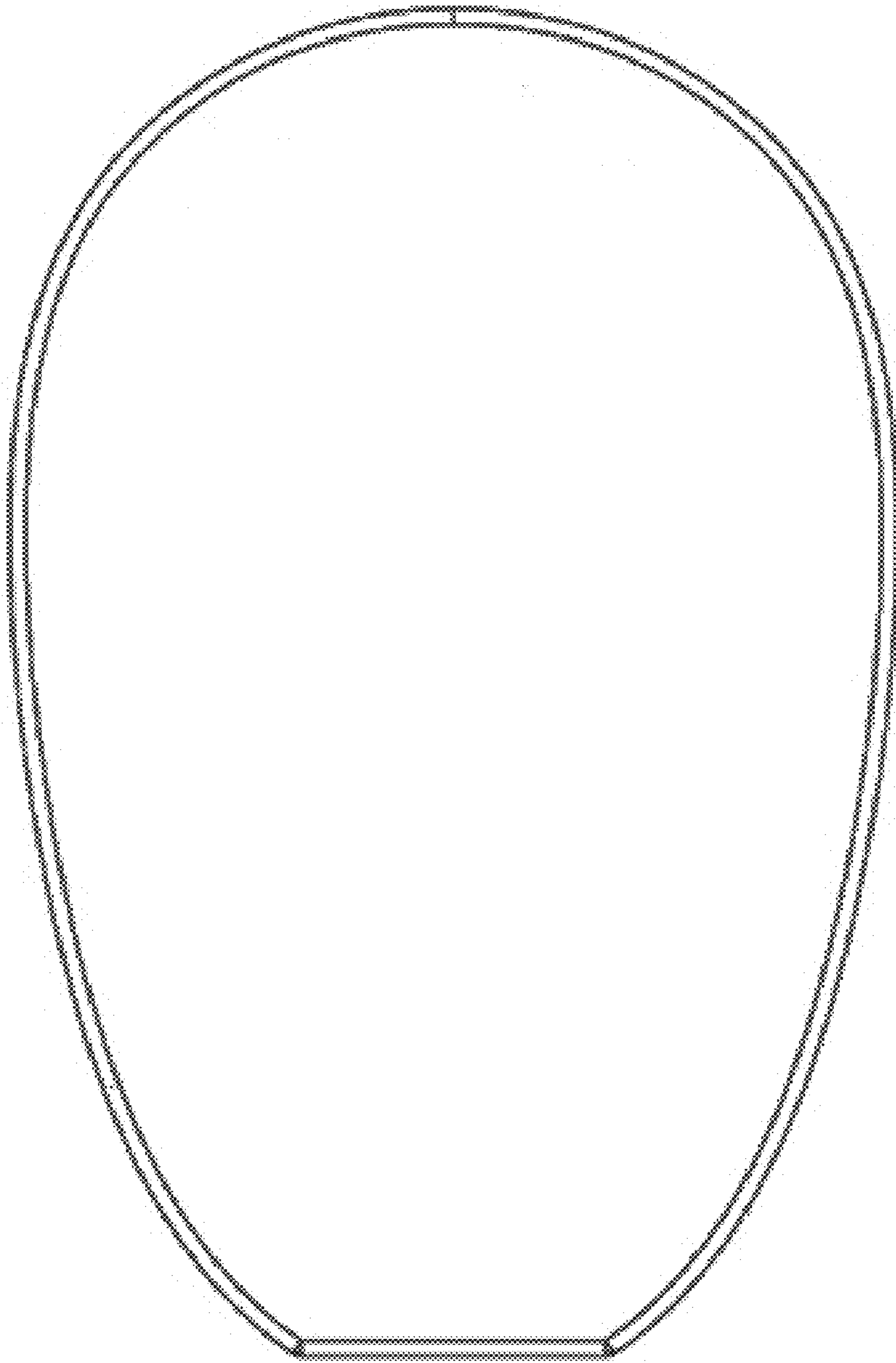

FIG. 7