

US00D646275S

(12) **United States Design Patent**
Ikeda et al.

(10) **Patent No.:** **US D646,275 S**
(45) **Date of Patent:** **** Oct. 4, 2011**

(54) **GAME CONTROLLER WITH ELONGATED CONTROLLER ELEMENT**

(75) Inventors: **John Ikeda**, Seattle, WA (US); **Carl L. Ledbetter**, Mercer Island, WA (US); **Peter Bristol**, Redmond, WA (US)

(73) Assignee: **Microsoft Corporation**, Redmond, WA (US)

(**) Term: **14 Years**

(21) Appl. No.: **29/368,840**

(22) Filed: **Aug. 30, 2010**

(51) **LOC (9) Cl.** **14-02**

(52) **U.S. Cl.** **D14/401; D14/454; D21/333**

(58) **Field of Classification Search** D14/217, D14/218, 356, 388, 399-401, 412-416, 432, D14/434, 454-457, 496; D21/324, 332, D21/333; 463/1, 30, 36-38, 46, 47; 345/156-161, 345/905

See application file for complete search history.

(56) **References Cited**

U.S. PATENT DOCUMENTS

D348,083 S	6/1994	Smith, III et al.	
D417,211 S	11/1999	Kaneko et al.	
D420,660 S *	2/2000	Chen	D14/401
D421,433 S	3/2000	Alviar et al.	
D424,047 S	5/2000	Chan	
D432,180 S *	10/2000	Hayes	D21/333
D433,076 S	10/2000	Hayes	
D435,551 S	12/2000	Hayes	
D451,513 S	12/2001	Stewart et al.	
D452,505 S	12/2001	Stewart et al.	
D453,758 S	2/2002	Han et al.	

D453,932 S	2/2002	Han et al.	
D521,015 S	5/2006	Hayes et al.	
D522,011 S *	5/2006	Hayes et al.	D14/454
D522,012 S *	5/2006	Hayes et al.	D14/454
D547,763 S *	7/2007	Hayes et al.	D14/454
D581,422 S	11/2008	Hayes et al.	
D608,784 S *	1/2010	Biheller	D14/401
D615,595 S	5/2010	Williamson et al.	

OTHER PUBLICATIONS

Xbox 360 Wireless Controller, 1 color sheet, Microsoft, 2005.

* cited by examiner

Primary Examiner — Stella Reid

Assistant Examiner — Keli L Hill

(74) *Attorney, Agent, or Firm* — Banner & Witcoff, Ltd.

(57) **CLAIM**

The ornamental design for a game controller with elongated controller element, as shown and described.

DESCRIPTION

FIG. 1 is a front perspective view of a game controller with elongated controller element showing our new design; FIG. 2 is a front view thereof; FIG. 3 is a top view thereof; FIG. 4 is a bottom view thereof; FIG. 5 is a left side view thereof; FIG. 6 is a right side view thereof; and, FIG. 7 is a rear view thereof.

The broken lines shown are included for the purpose of illustrating the unclaimed portions of the article and form no part of the claim.

1 Claim, 4 Drawing Sheets

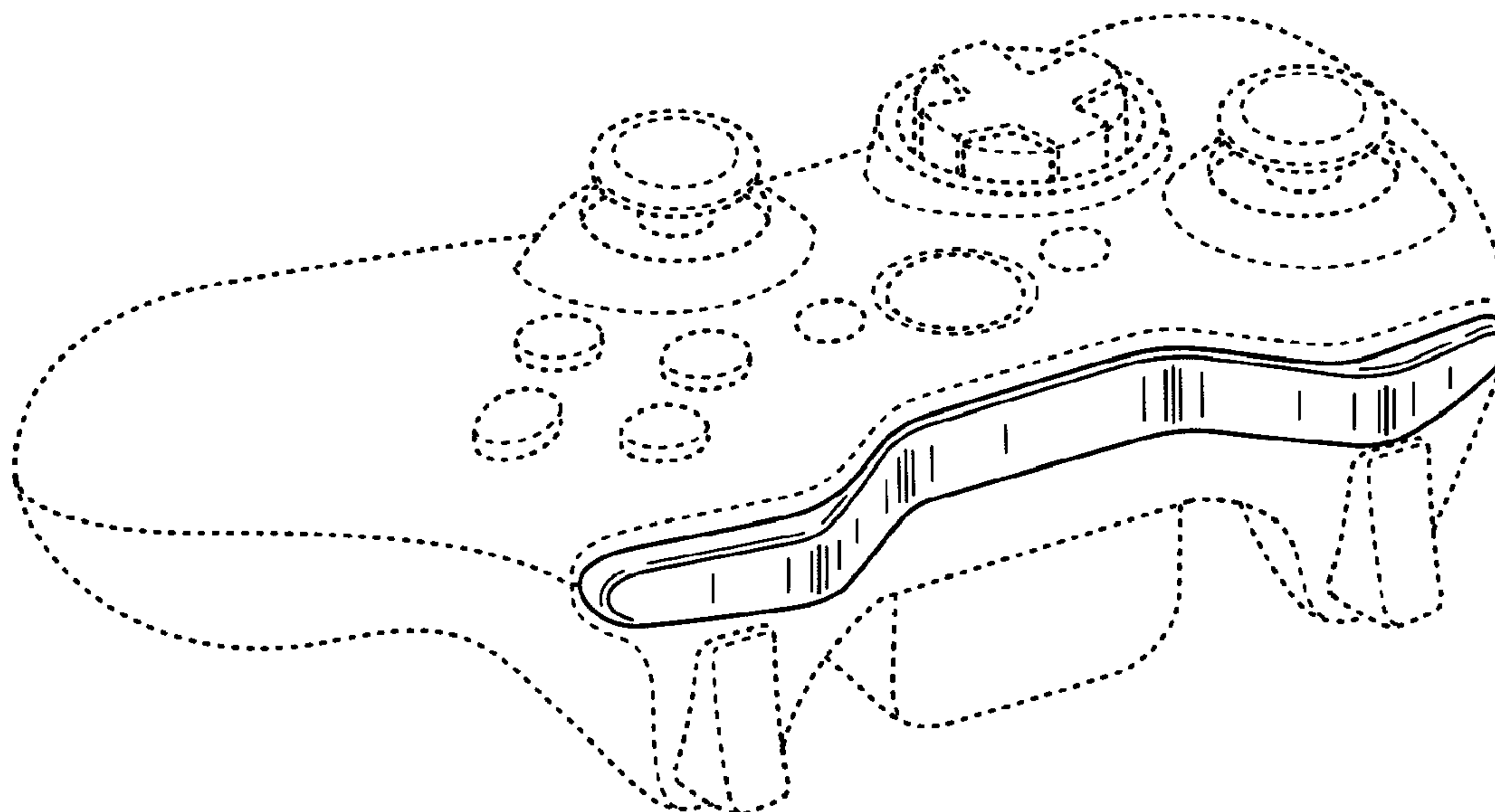

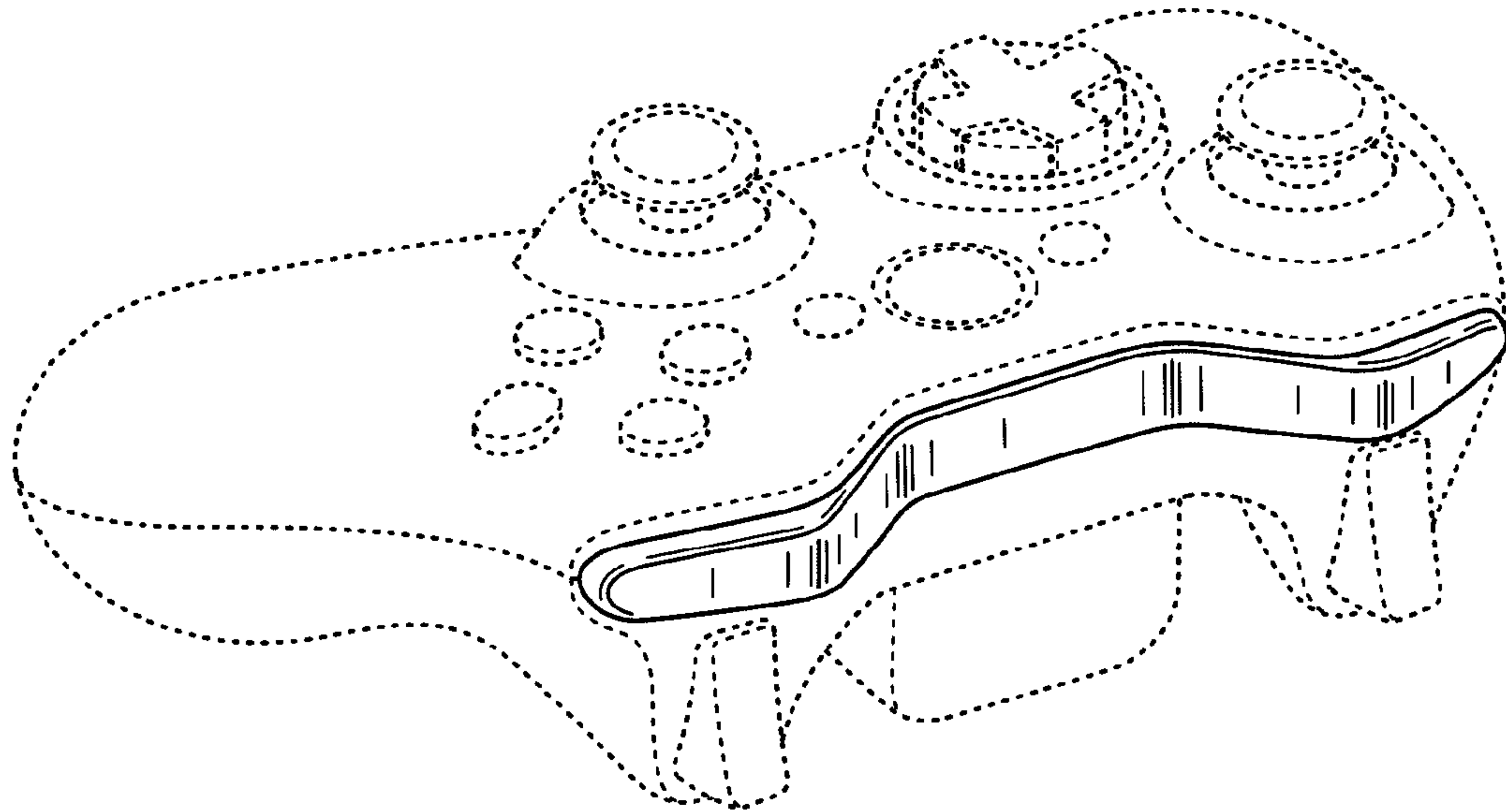

FIG. 1

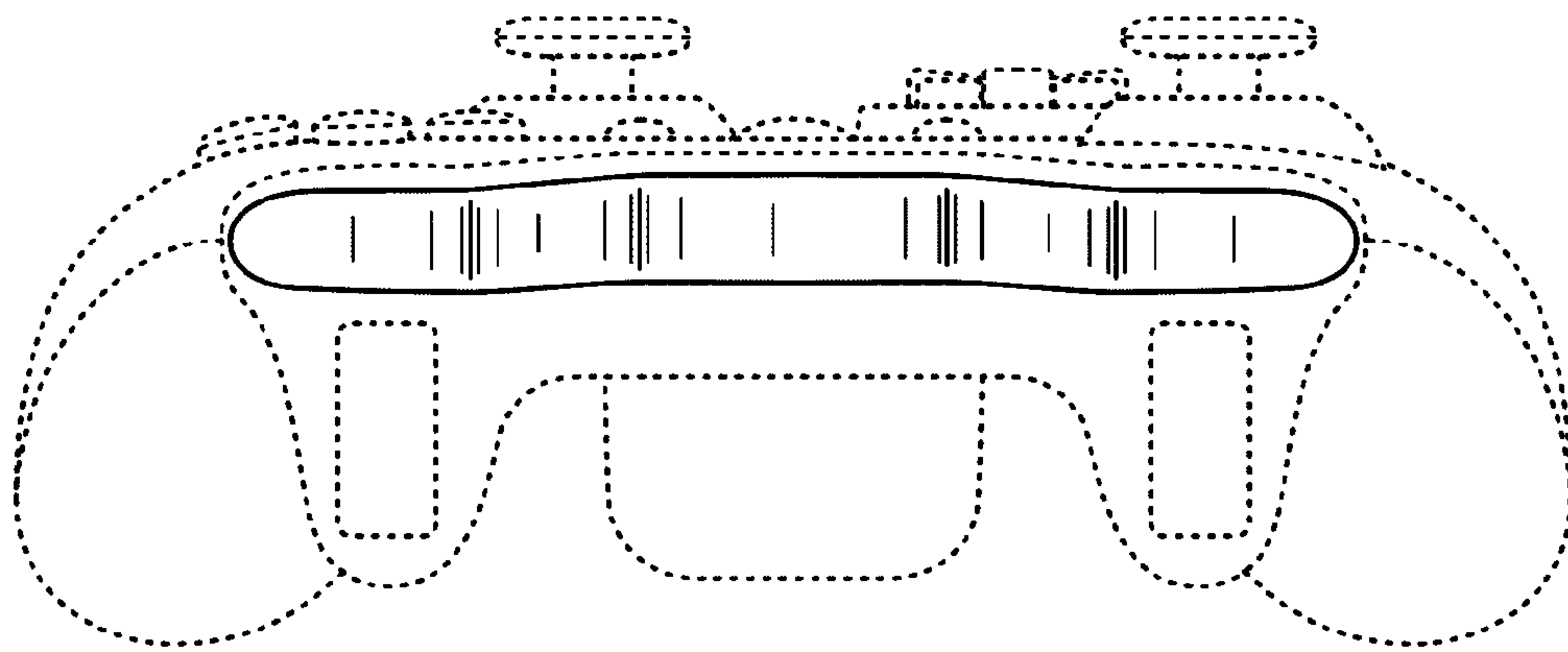

FIG. 2

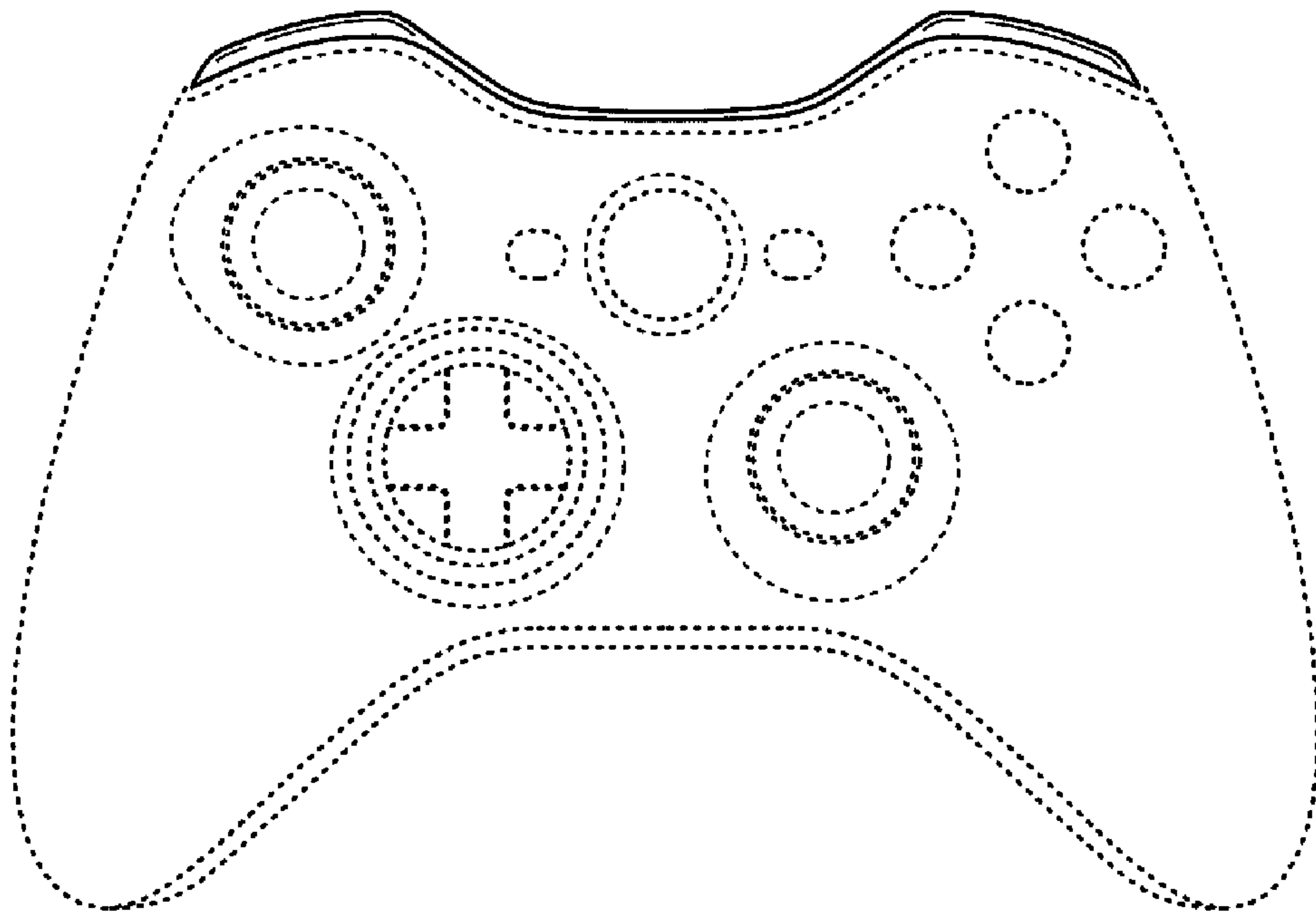

FIG. 3

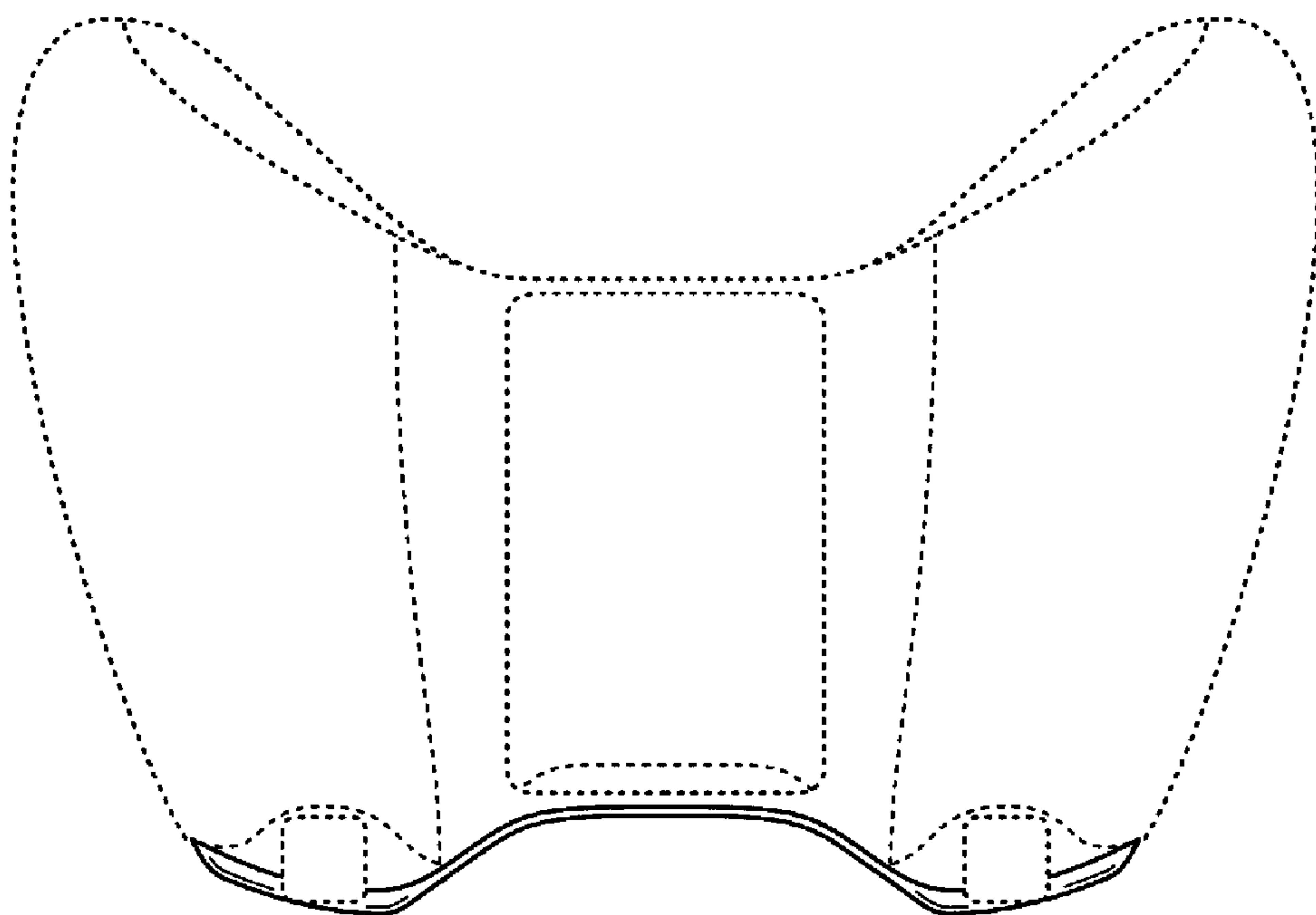

FIG. 4



FIG. 5

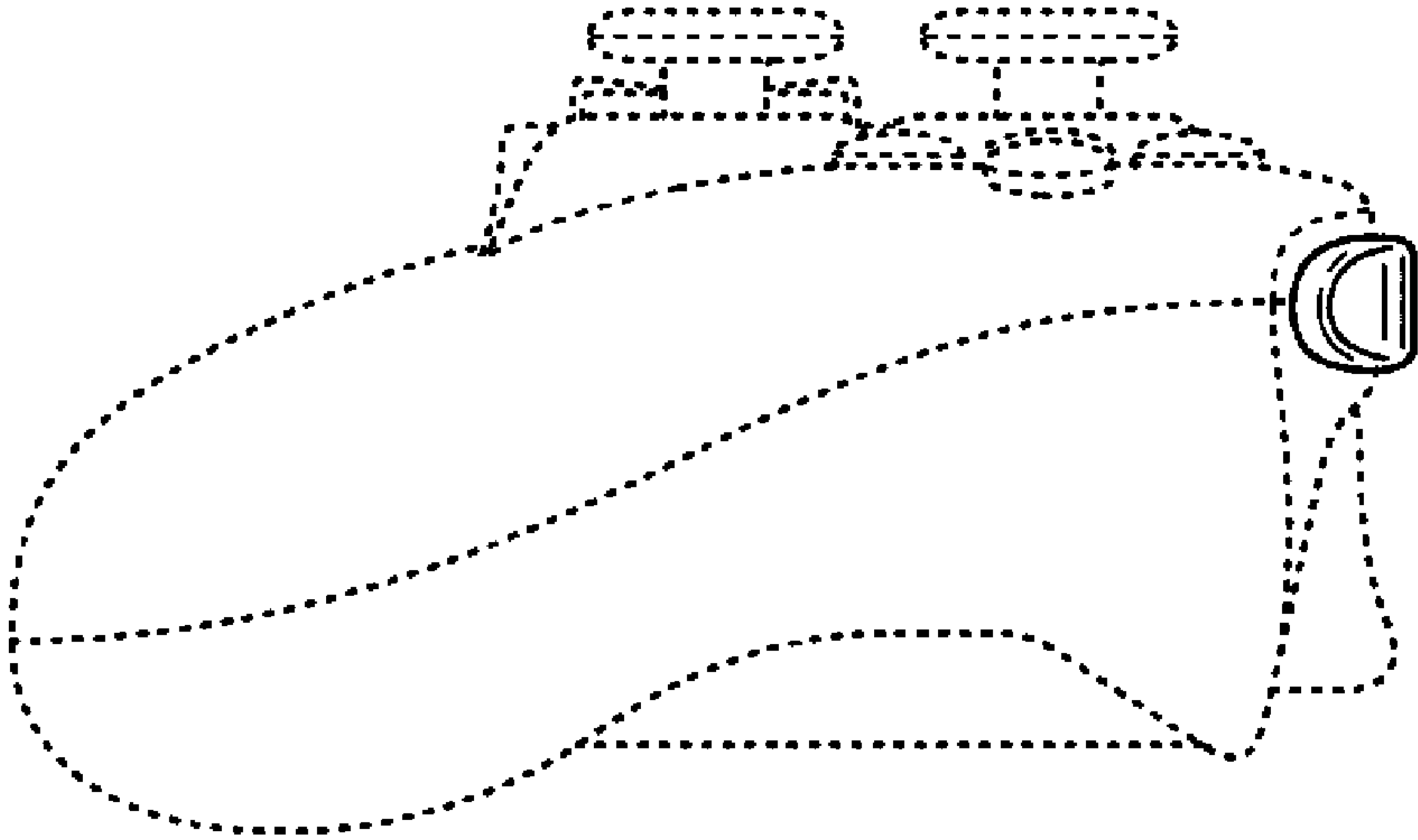

FIG. 6

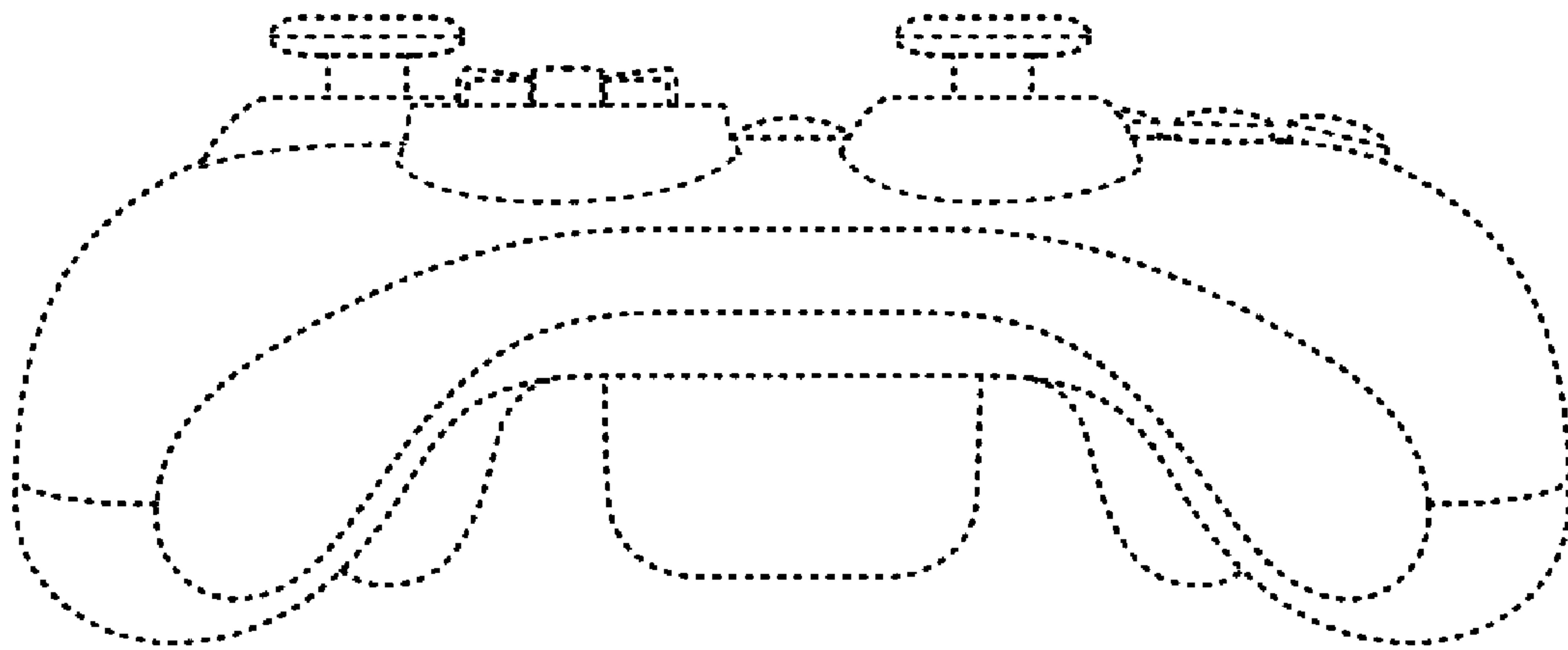

FIG. 7