



US00D646264S

(12) **United States Design Patent**
Dong

(10) **Patent No.:** **US D646,264 S**
(45) **Date of Patent:** **** Oct. 4, 2011**

(54) **DUAL PROTECTOR COVER**

(75) Inventor: **Hong Dong**, Diamond Bar, CA (US)

(73) Assignee: **Valor Communication, Inc.**, City of Industry, CA (US)

(**) Term: **14 Years**

(21) Appl. No.: **29/348,050**

(22) Filed: **Nov. 20, 2009**

(51) **LOC (9) Cl.** **14-03**

(52) **U.S. Cl.** **D14/250**

(58) **Field of Classification Search** D14/203.7,
D14/217, 250, 251, 253, 432, 440, 447, 496;
D3/201, 215, 218, 269, 294; D13/103; 220/4.02;
224/191, 240, 241, 245, 682, 683
See application file for complete search history.

(56) **References Cited**

U.S. PATENT DOCUMENTS

D620,000 S * 7/2010 Bau D14/250
(Continued)

Primary Examiner — Susan Bennett Hattan

Assistant Examiner — Barbara B Lohr

(74) *Attorney, Agent, or Firm* — Thomas I. Rozsa

(57) **CLAIM**

The ornamental design for a dual protector cover, as shown and described.

DESCRIPTION

FIG. 1 is a top perspective view of the dual protector cover which is a combination of a soft rubber cover and an outer hard plastic cover, showing my design;
FIG. 2 is a bottom perspective view thereof;
FIG. 3 is an end view when viewed from the right side with the bottom of the dual protector cover facing upwardly;

FIG. 4 is an end view when viewed from the left side with the top of the dual protector cover facing upwardly;
FIG. 5 is a side elevational view of the dual protector cover with the bottom of the cover facing to the left and the top of the cover facing to the right;
FIG. 6 is a side elevational of the dual protector cover with the top of the cover facing to the left and the bottom of the cover facing to the right;
FIG. 7 is a top plan view thereof;
FIG. 8 is a bottom plan view thereof;
FIG. 9 is an end view when viewed from the right side of the interior soft rubber cover removed from the hard plastic cover for clarity of illustration with the bottom of the soft rubber cover facing upwardly;
FIG. 10 is an end view when viewed from the left side of the interior soft rubber cover removed from the hard plastic cover for clarity of illustration with the top of the cover facing upwardly;
FIG. 11 is a side elevational view of the soft rubber cover with the bottom facing to the left and the top facing to the right;
FIG. 12 is a side elevational view of the soft rubber cover with the top facing to the left and the bottom facing to the right;
FIG. 13 is a top plan view of the soft rubber cover;
FIG. 14 is a bottom plan view of the soft rubber cover;
FIG. 15 is an end view when viewed from the right side of the hard plastic cover shown separately for clarity of illustration with the bottom of the cover facing upwardly;
FIG. 16 is a left end view of the hard plastic cover with the top of the cover facing upwardly;
FIG. 17 is a side elevational view of the hard plastic cover with the bottom of the cover facing to the left and the top of the cover facing the right;
FIG. 18 is a side elevational view of the hard plastic cover with the top of the cover facing to the right and the bottom of the cover facing to the left;
FIG. 19 is a top plan view of the hard plastic cover;
FIG. 20 is a bottom plan view of the hard plastic cover; and,
FIG. 21 is a side elevational view showing the soft plastic cover to the left and the hard plastic cover to the right before they are combined into the final single product as illustrated in FIGS. 1-8.

1 Claim, 6 Drawing Sheets

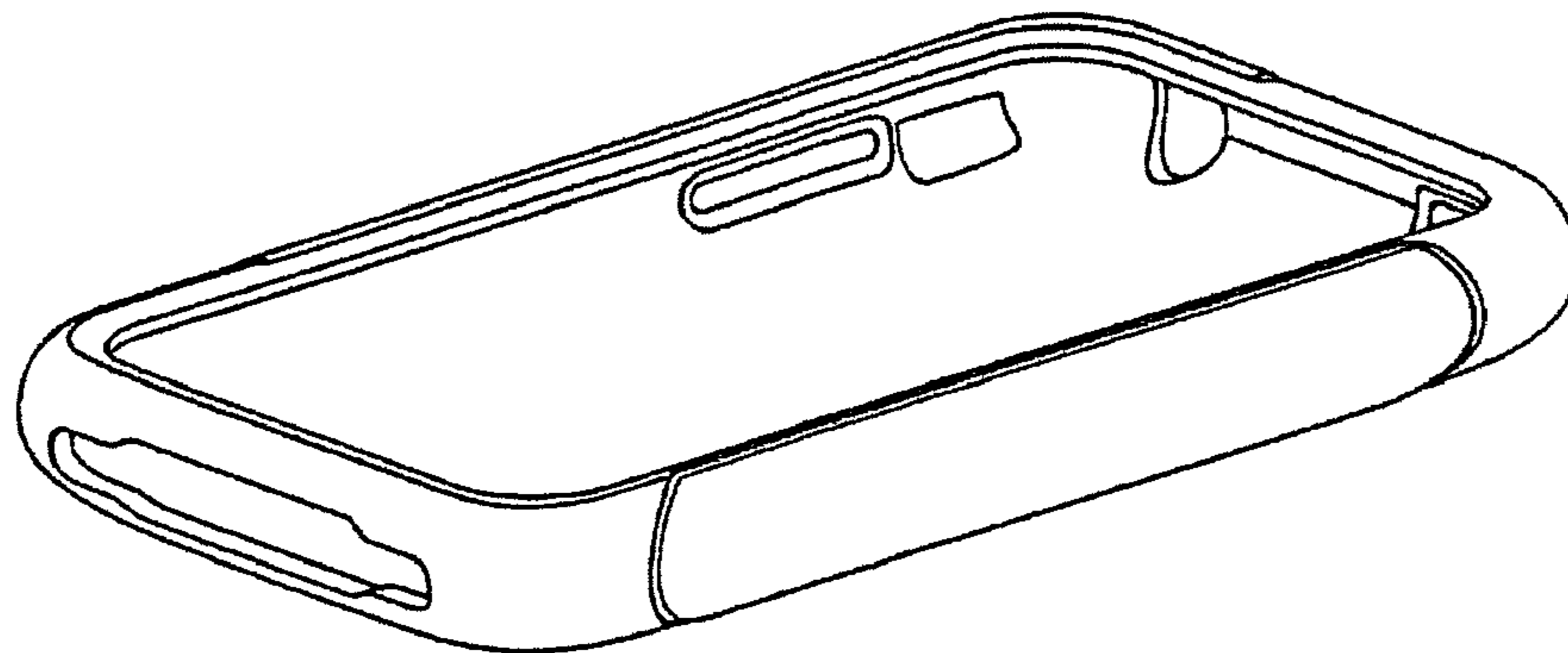

US D646,264 S

Page 2

U.S. PATENT DOCUMENTS

D638,007 S *	5/2011	Chang	D14/250	
D638,411 S *	5/2011	Willes et al.	D14/250	
D638,413 S *	5/2011	Magness et al.	D14/250	* cited by examiner
				D640,679 S * 6/2011 Willes et al. D14/250
				D640,680 S * 6/2011 Magness et al. D14/250

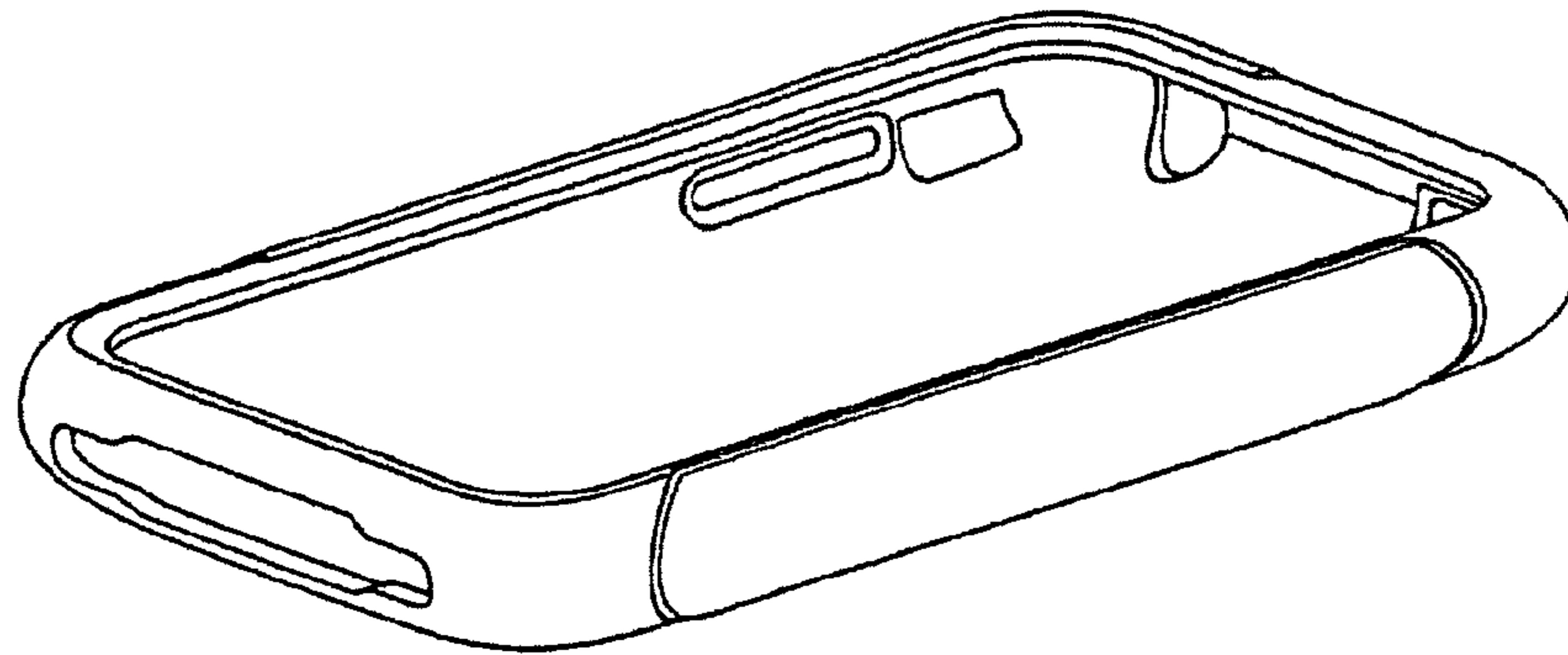

FIG.1

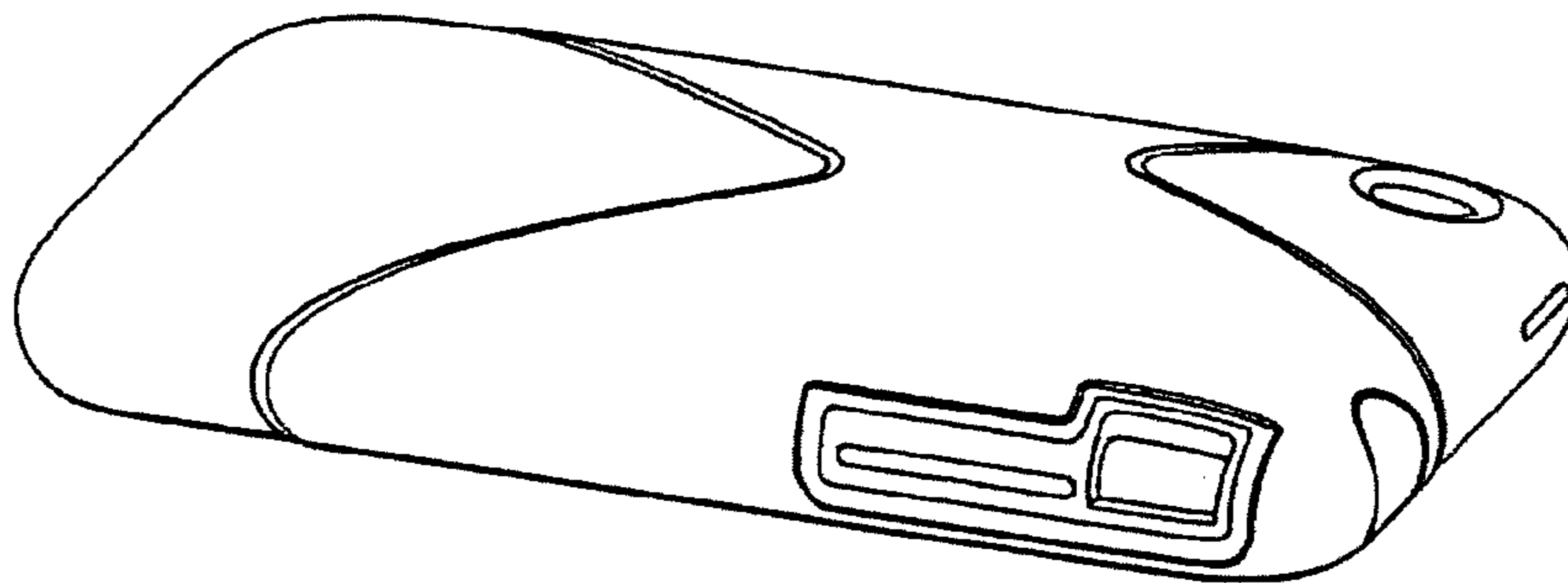

FIG.2

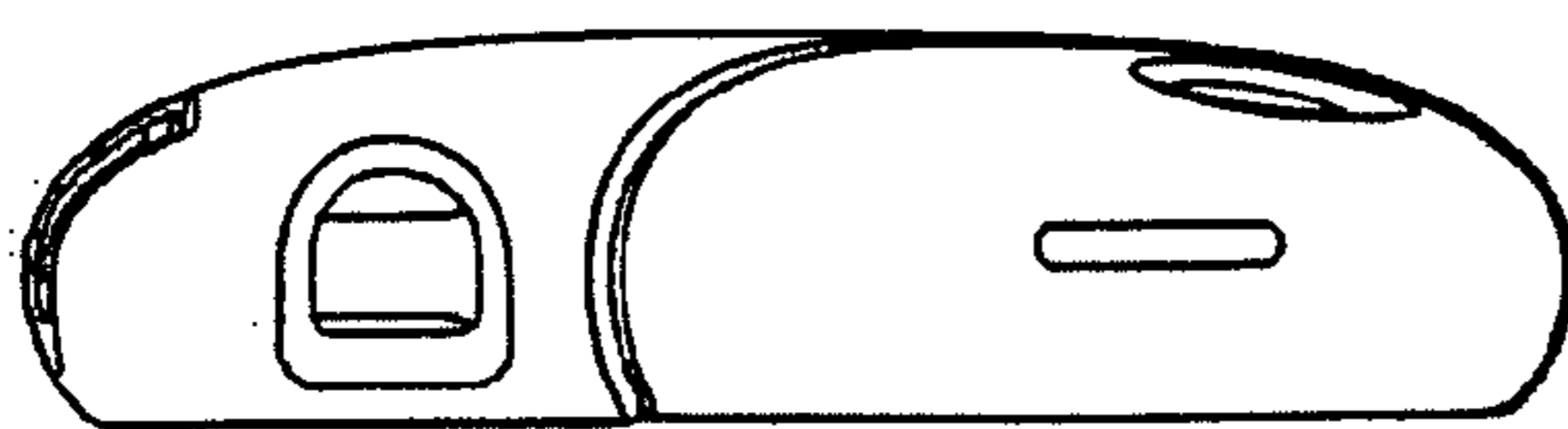

FIG.3

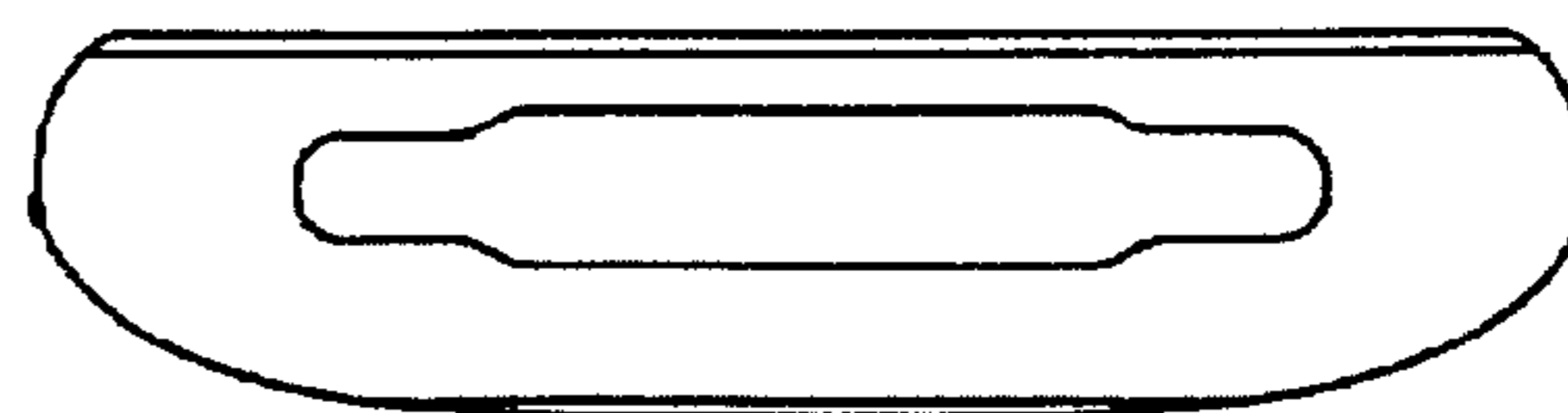

FIG.4

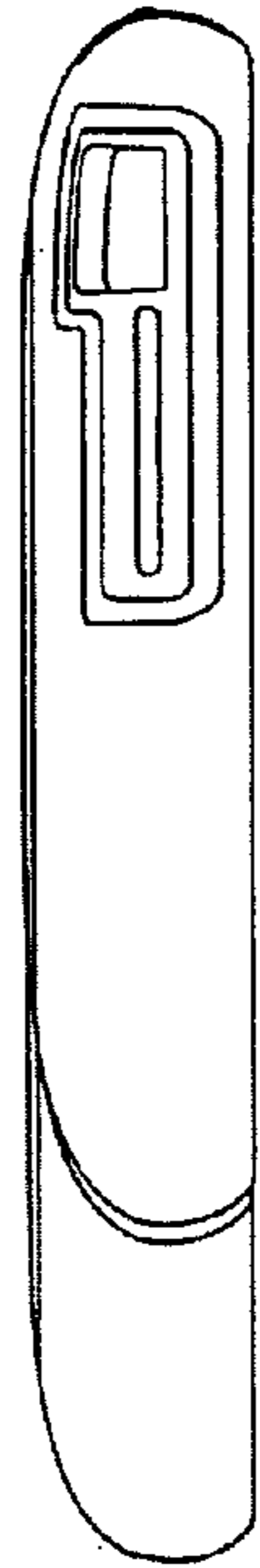

FIG. 5

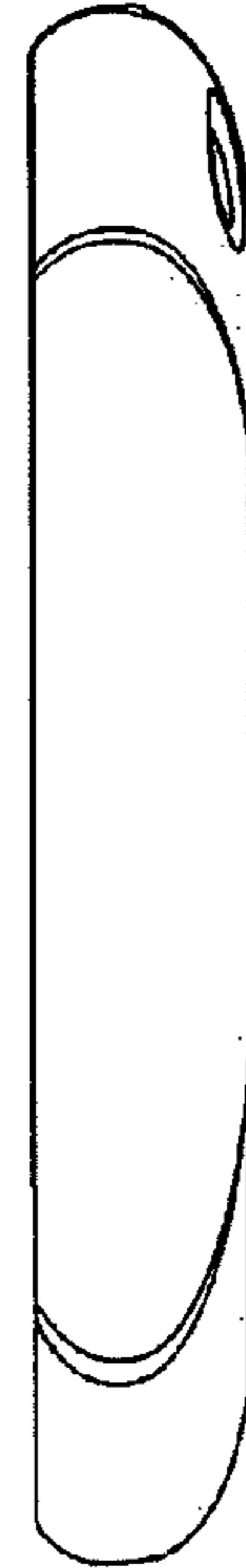

FIG. 6

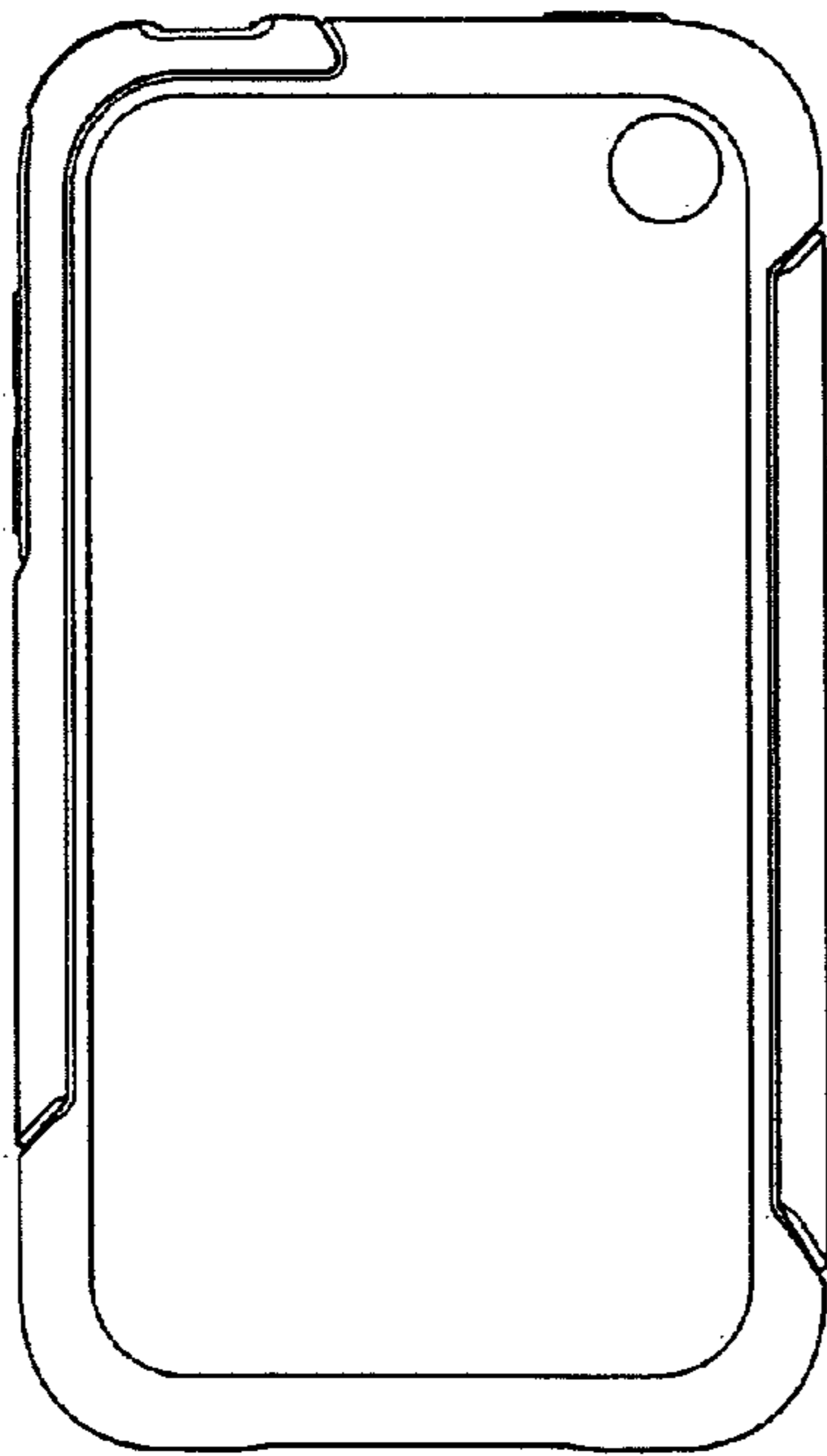

FIG. 7

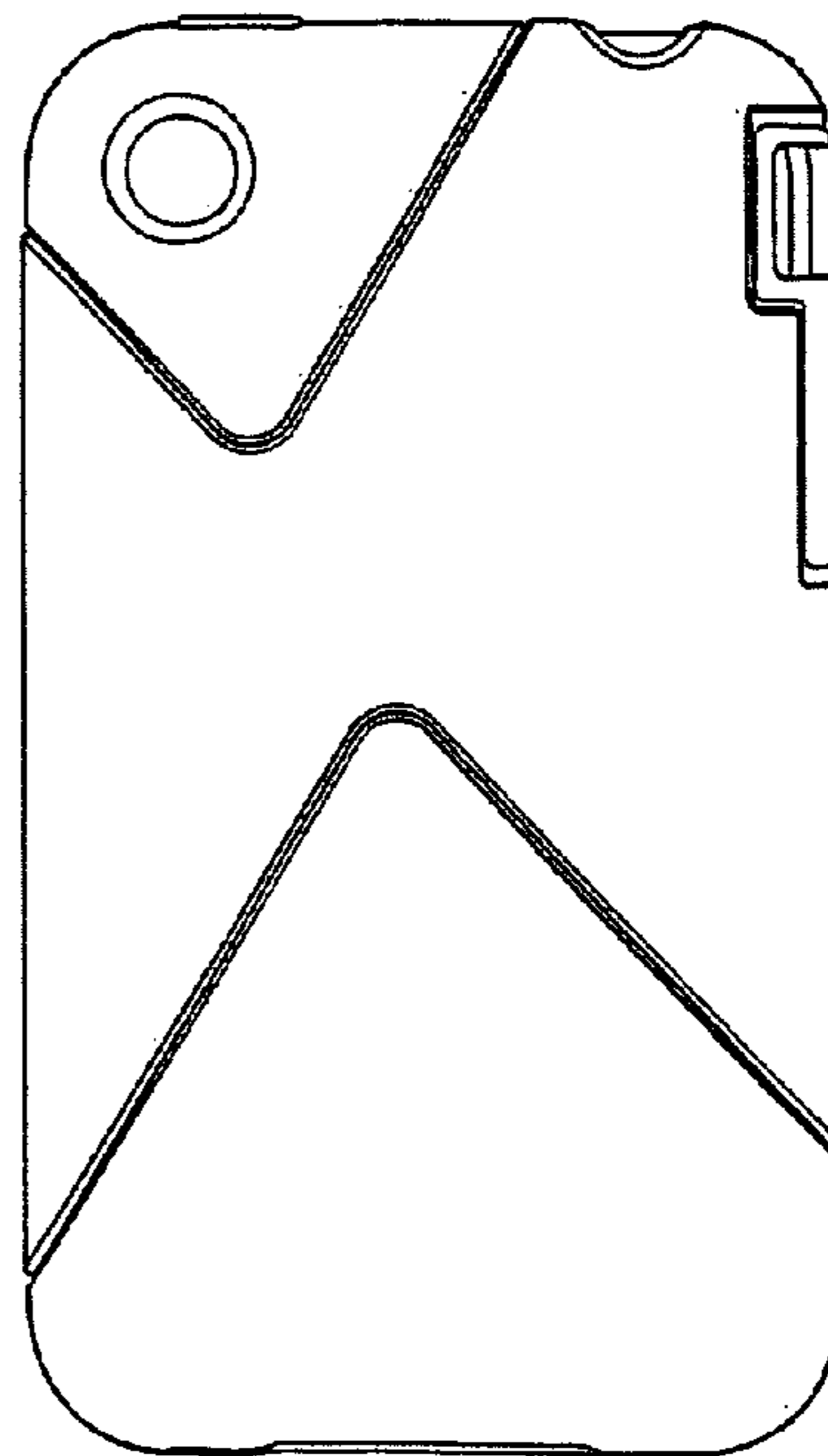

FIG. 8

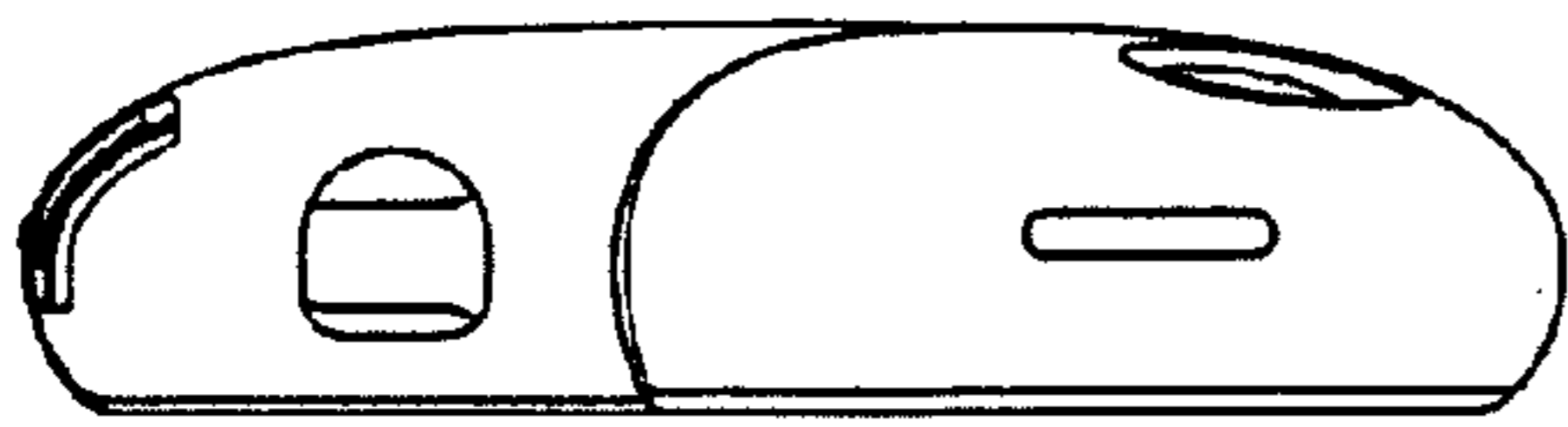

FIG. 9

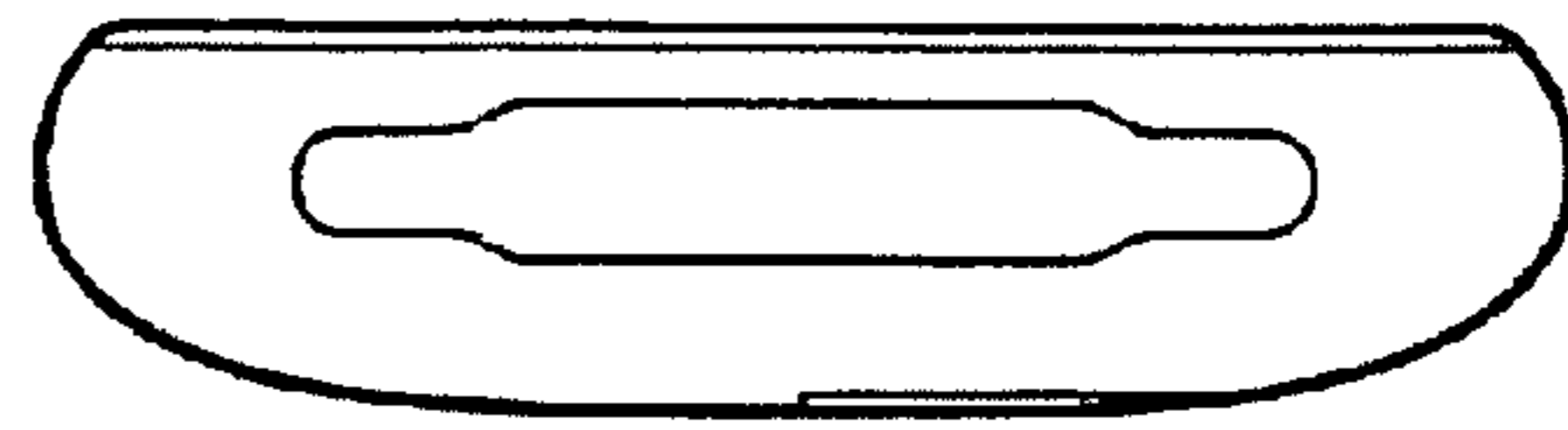

FIG. 10

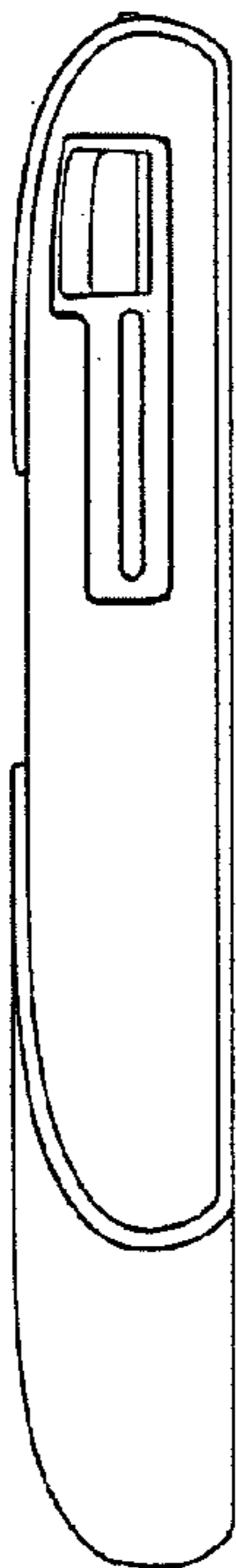

FIG. 11

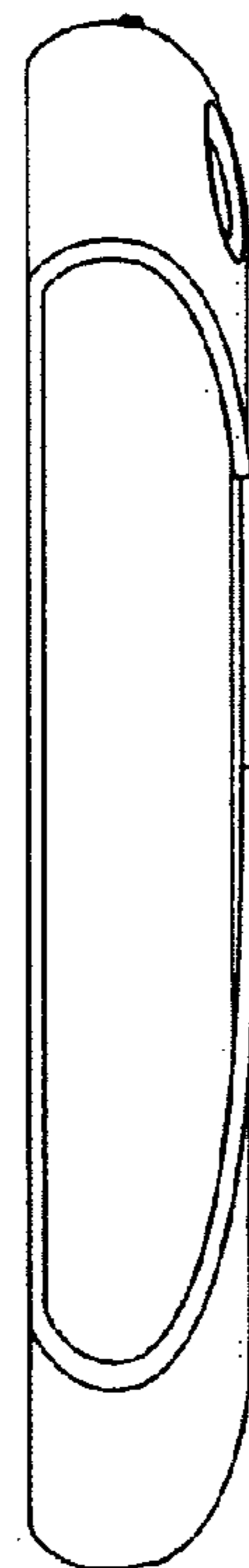

FIG. 12

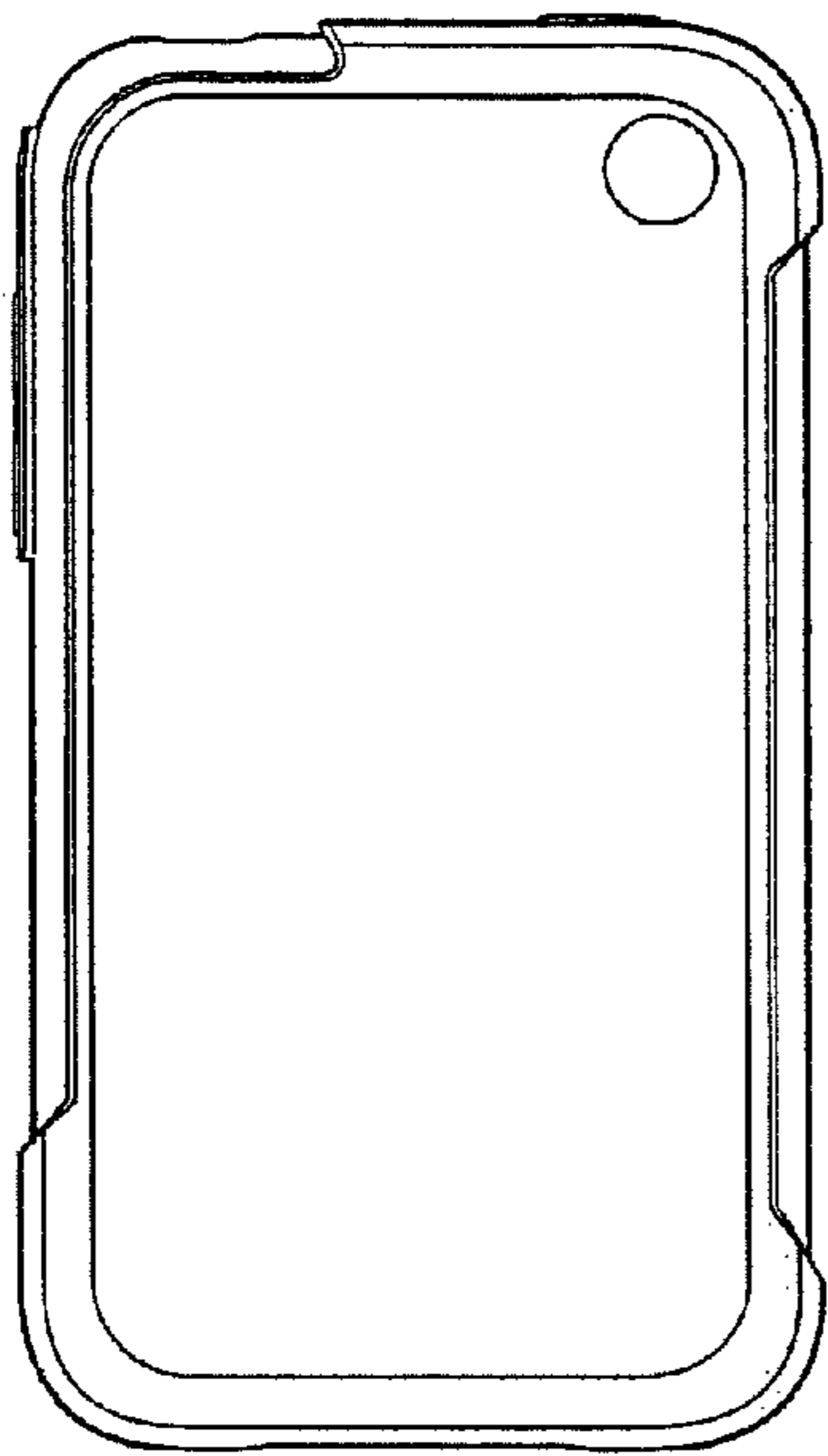

FIG.13

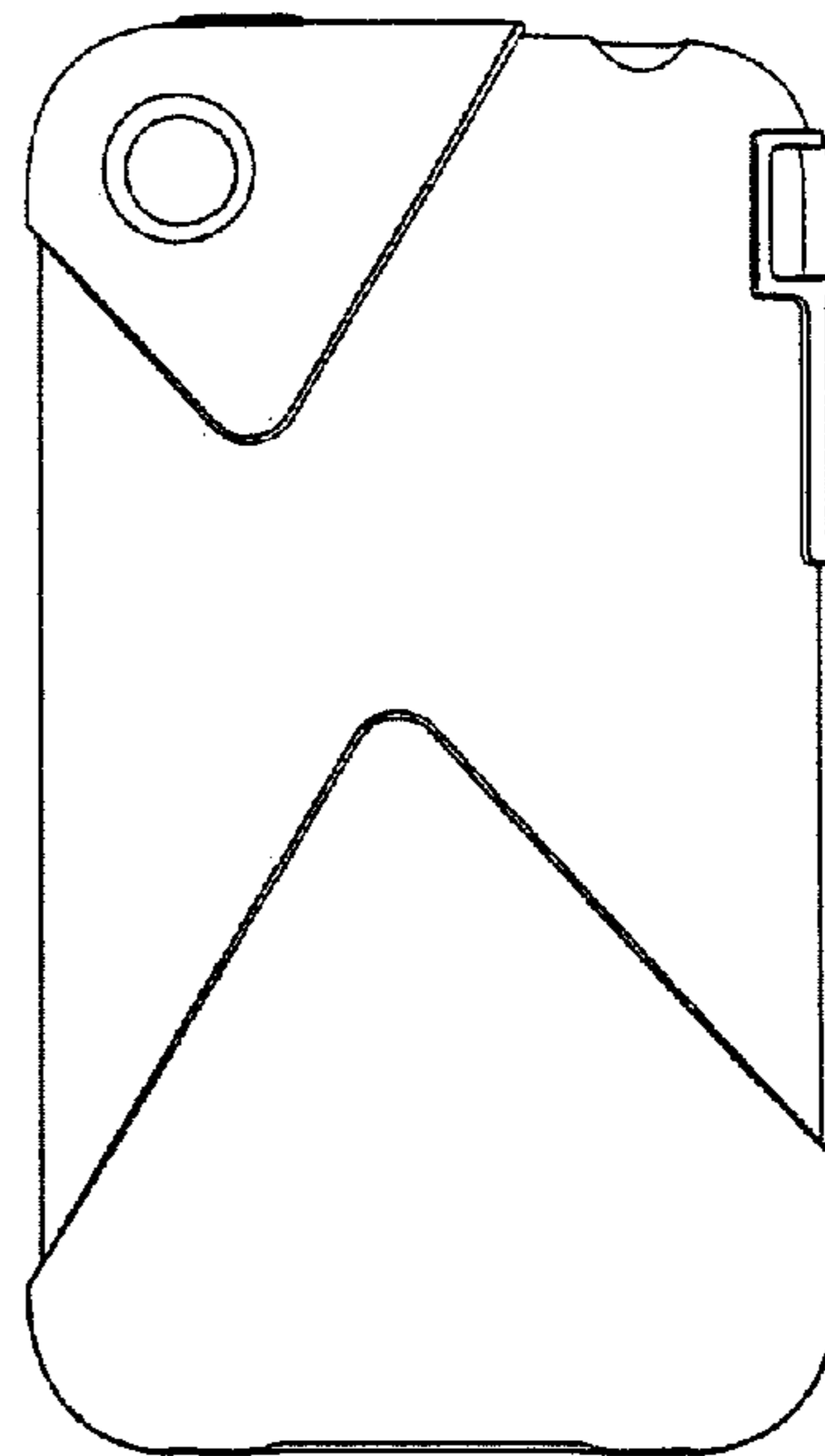

FIG.14

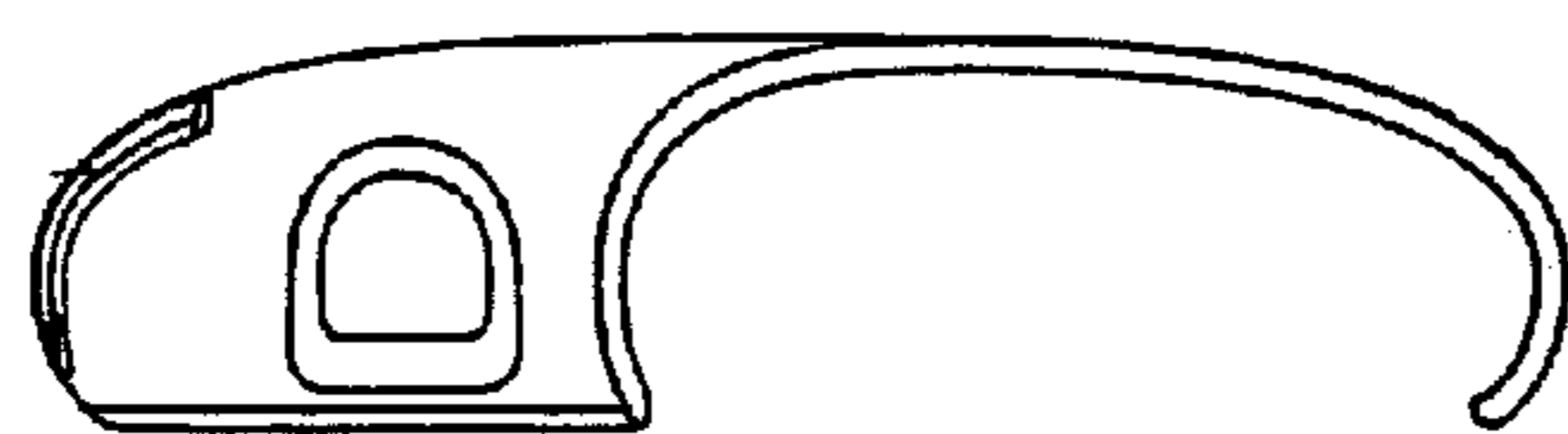

FIG.15

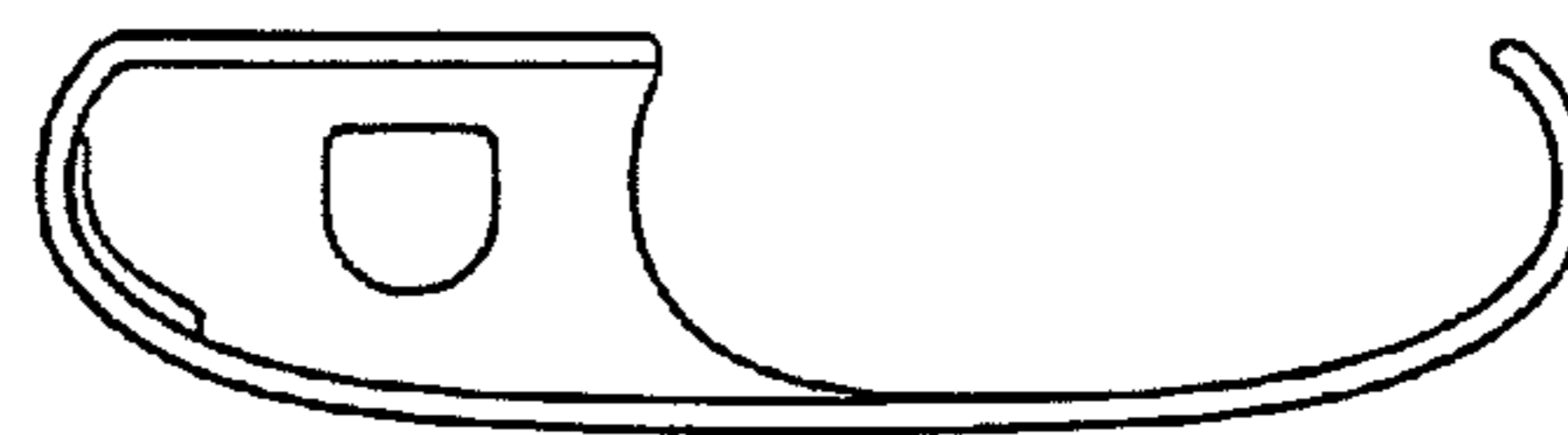

FIG.16

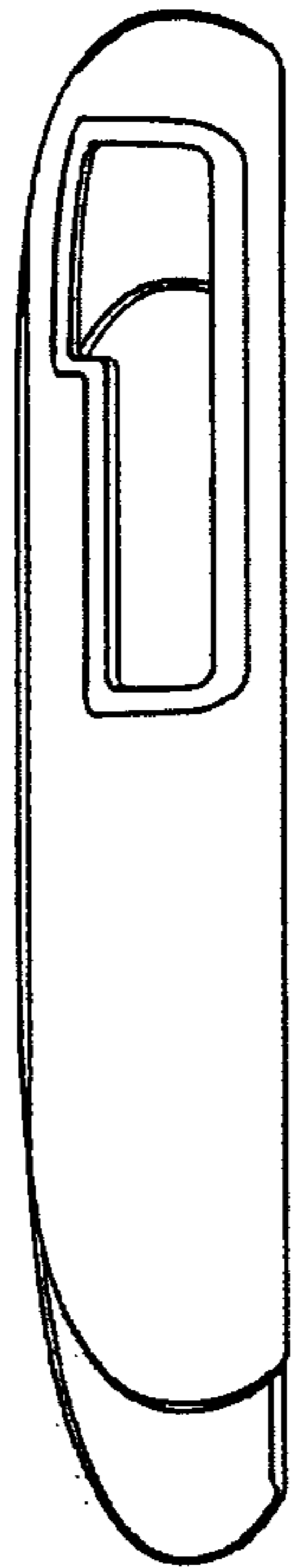

FIG.17

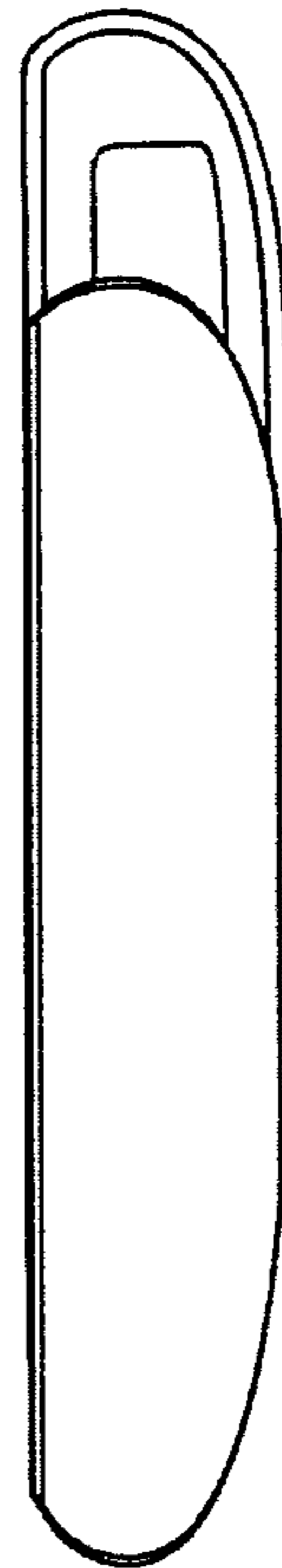

FIG.18

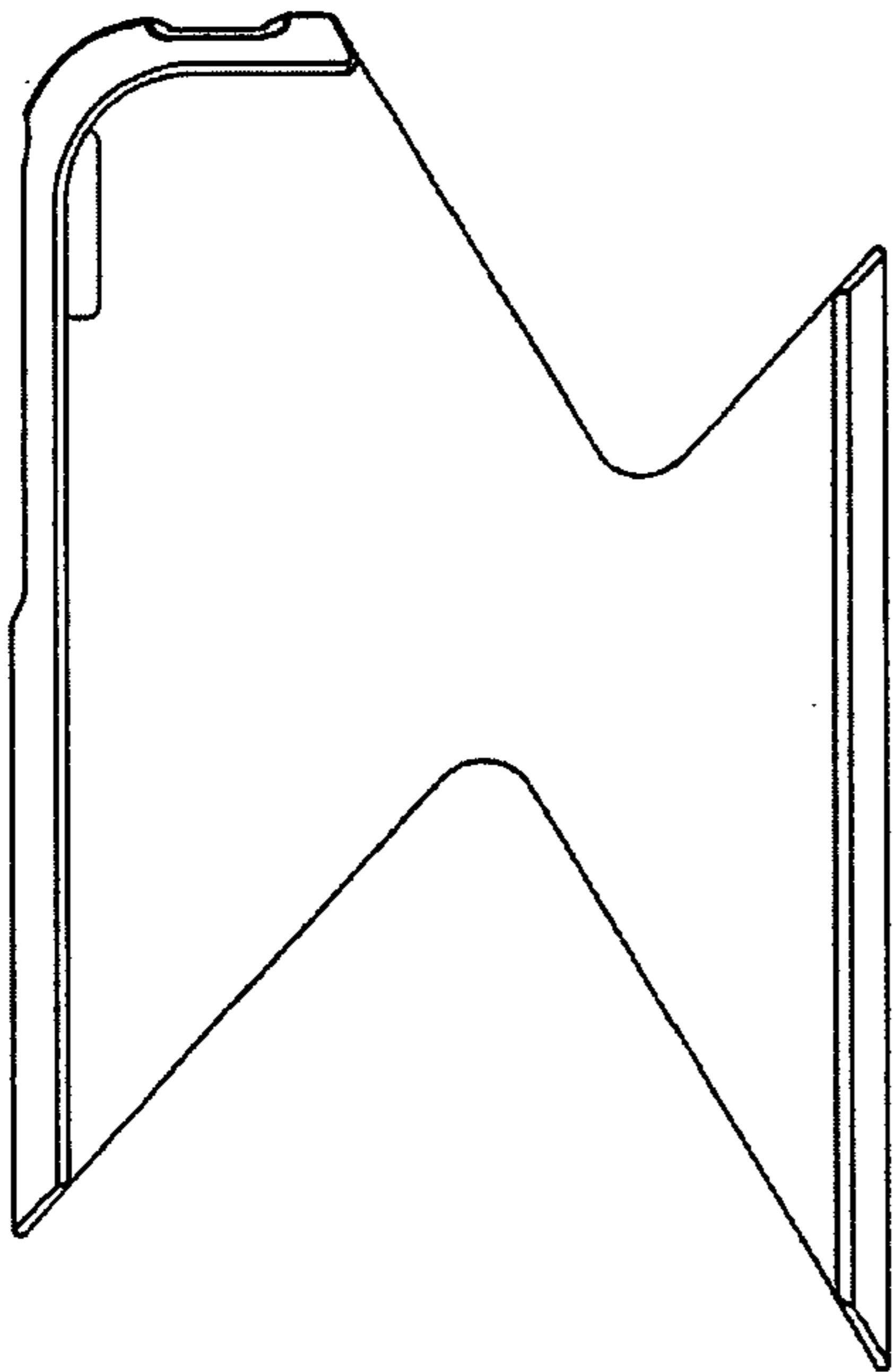

FIG.19

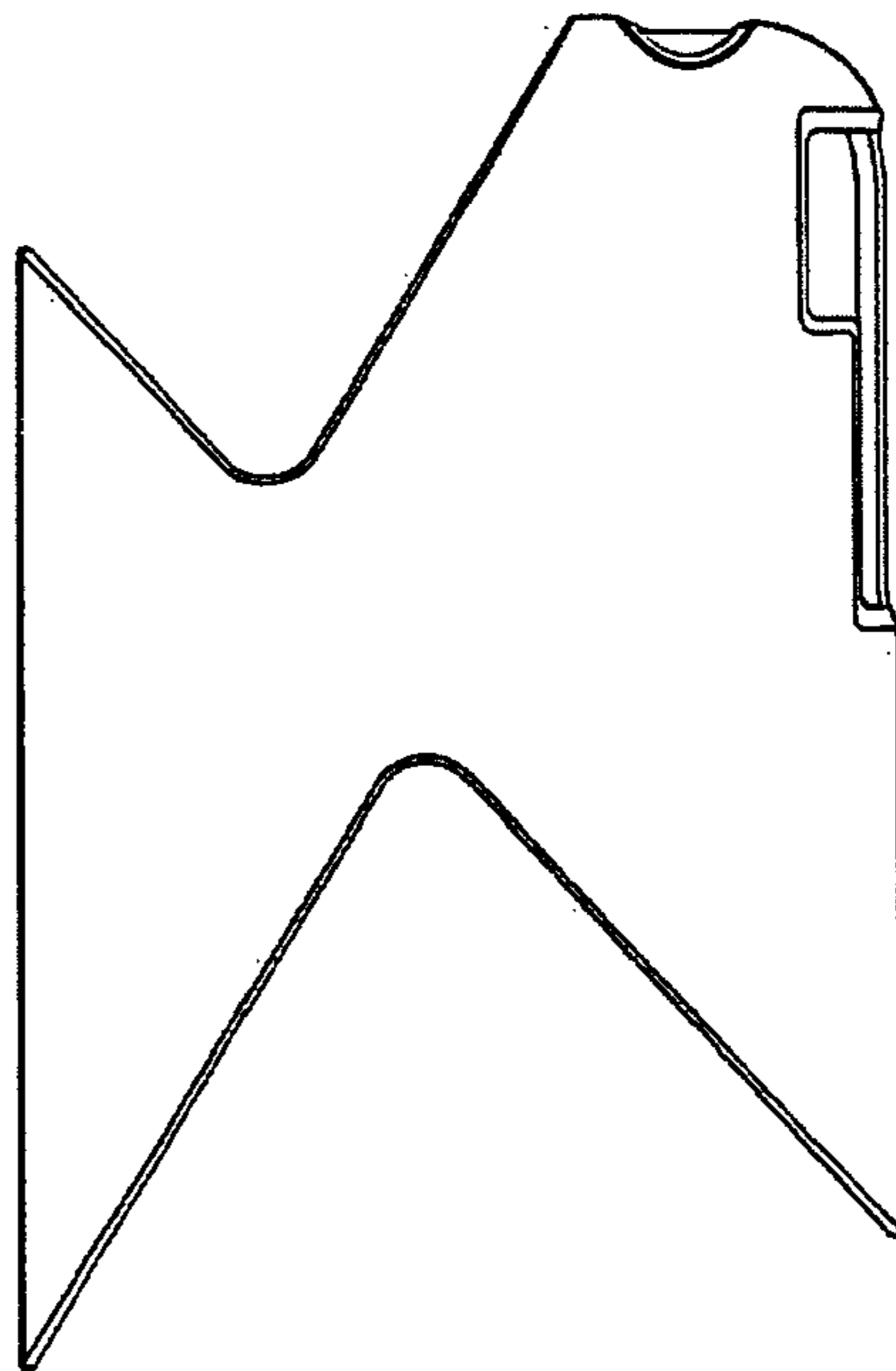

FIG.20

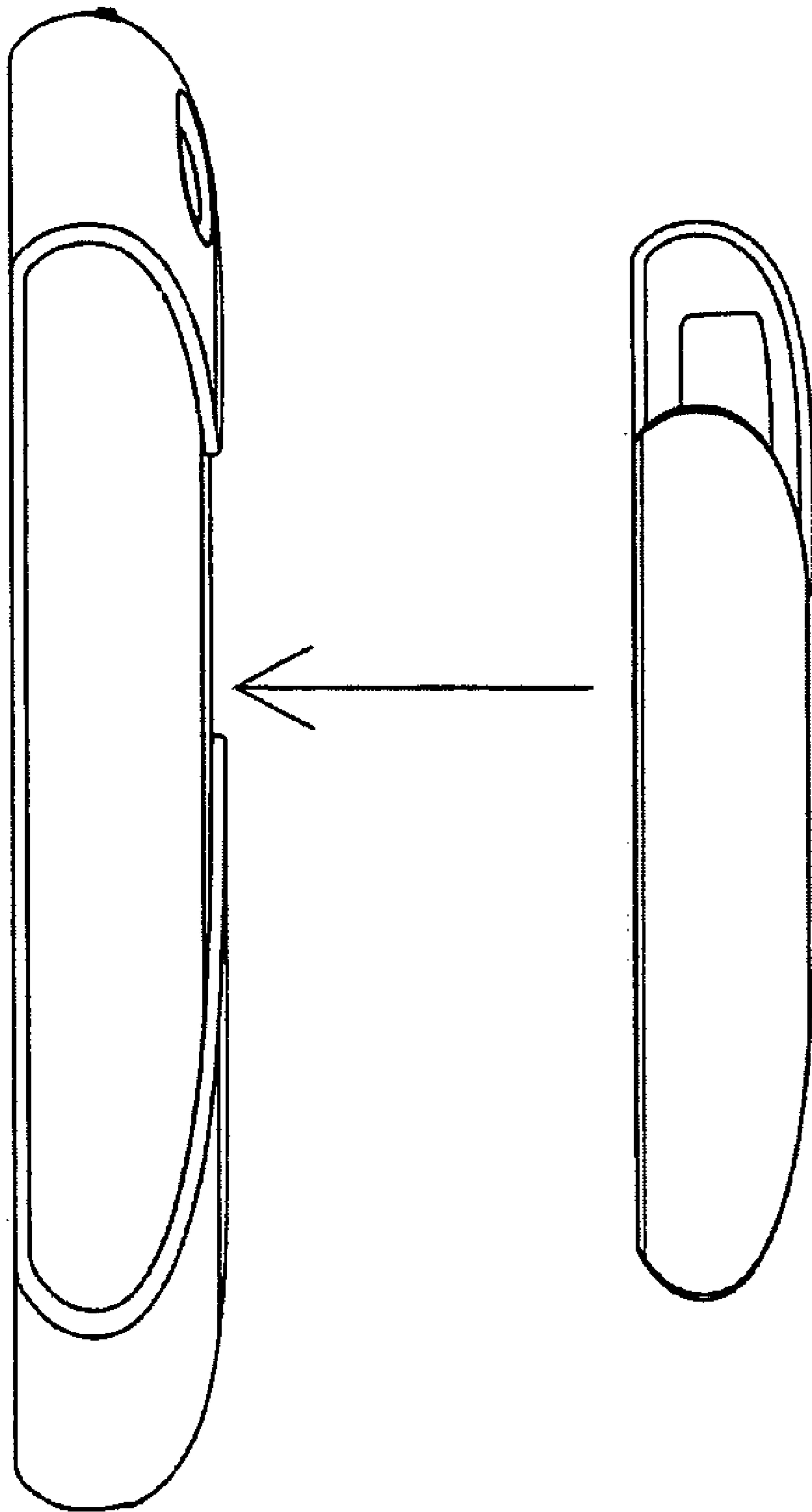

FIG.21