



US00D646228S

(12) **United States Design Patent**  
**Montena et al.**

(10) **Patent No.:** **US D646,228 S**

(45) **Date of Patent:** **\*\* Oct. 4, 2011**

(54) **WEATHER PROOFING SYSTEM**

(75) Inventors: **Noah Montena**, Syracuse, NY (US);  
**Chris Natoli**, Fulton, NY (US)

(73) Assignee: **John Mezzalingua Associates, Inc.**,  
East Syracuse, NY (US)

(\*\*) Term: **14 Years**

(21) Appl. No.: **29/377,394**

(22) Filed: **Oct. 20, 2010**

(51) **LOC (9) Cl.** ..... **13-03**

(52) **U.S. Cl.** ..... **D13/156**

(58) **Field of Classification Search** ..... D13/133,  
D13/146-147, 154, 156, 184, 199; 439/271,  
439/275, 277, 278, 279, 281, 283, 445, 447,  
439/578, 583, 584, 927

See application file for complete search history.

(56) **References Cited**

U.S. PATENT DOCUMENTS

3,518,600 A \* 6/1970 Urani ..... 337/201  
4,323,727 A \* 4/1982 Berg ..... 174/135  
D331,567 S \* 12/1992 Braga et al. .... D13/156  
D407,378 S \* 3/1999 Lee ..... D13/156

7,086,897 B2 \* 8/2006 Montena ..... 439/578  
7,727,011 B2 \* 6/2010 Montena et al. .... 439/578  
D631,848 S \* 2/2011 Montena et al. .... D13/154  
2006/0240709 A1 \* 10/2006 Montena et al. .... 439/578

\* cited by examiner

*Primary Examiner* — Daniel Bui

(74) *Attorney, Agent, or Firm* — Stephen R. Yoder, Esq.

(57) **CLAIM**

The ornamental design for a weather proofing system, as shown and described.

**DESCRIPTION**

FIG. 1 is a front perspective view of the present invention showing our design for a weather proofing system; FIG. 2 is a back perspective view thereof; FIG. 3 is a top view thereof, the claimed portion of which is a mirror image to the bottom view thereof; FIG. 4 is a right side view thereof, the claimed portion of which is a mirror image of the left side view thereof; FIG. 5 is a front view thereof; and, FIG. 6 is a back view thereof.

The dash-dot line in the figure drawings is included for the purpose of illustrating environment and forms no part of the claimed design.

**1 Claim, 5 Drawing Sheets**

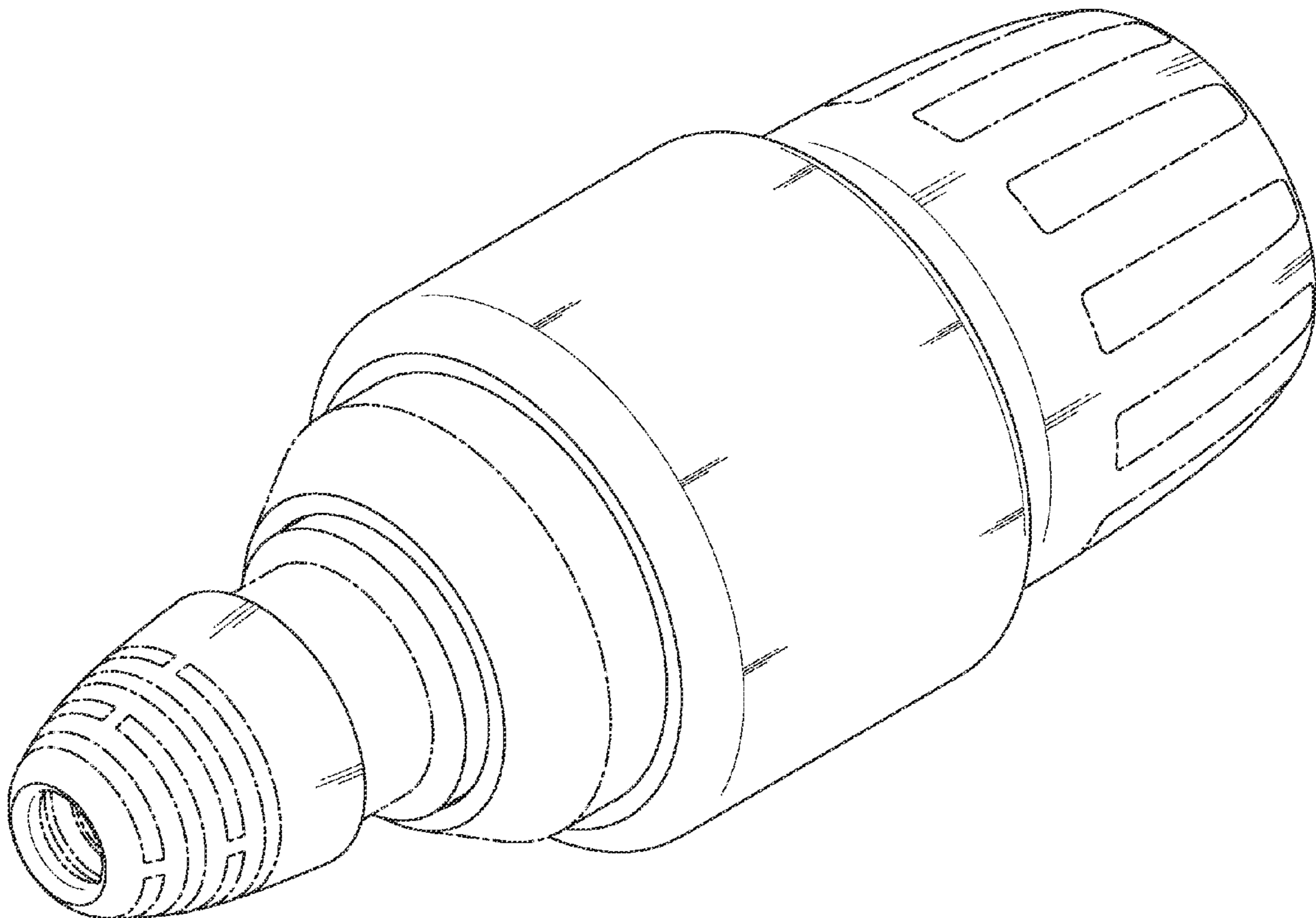

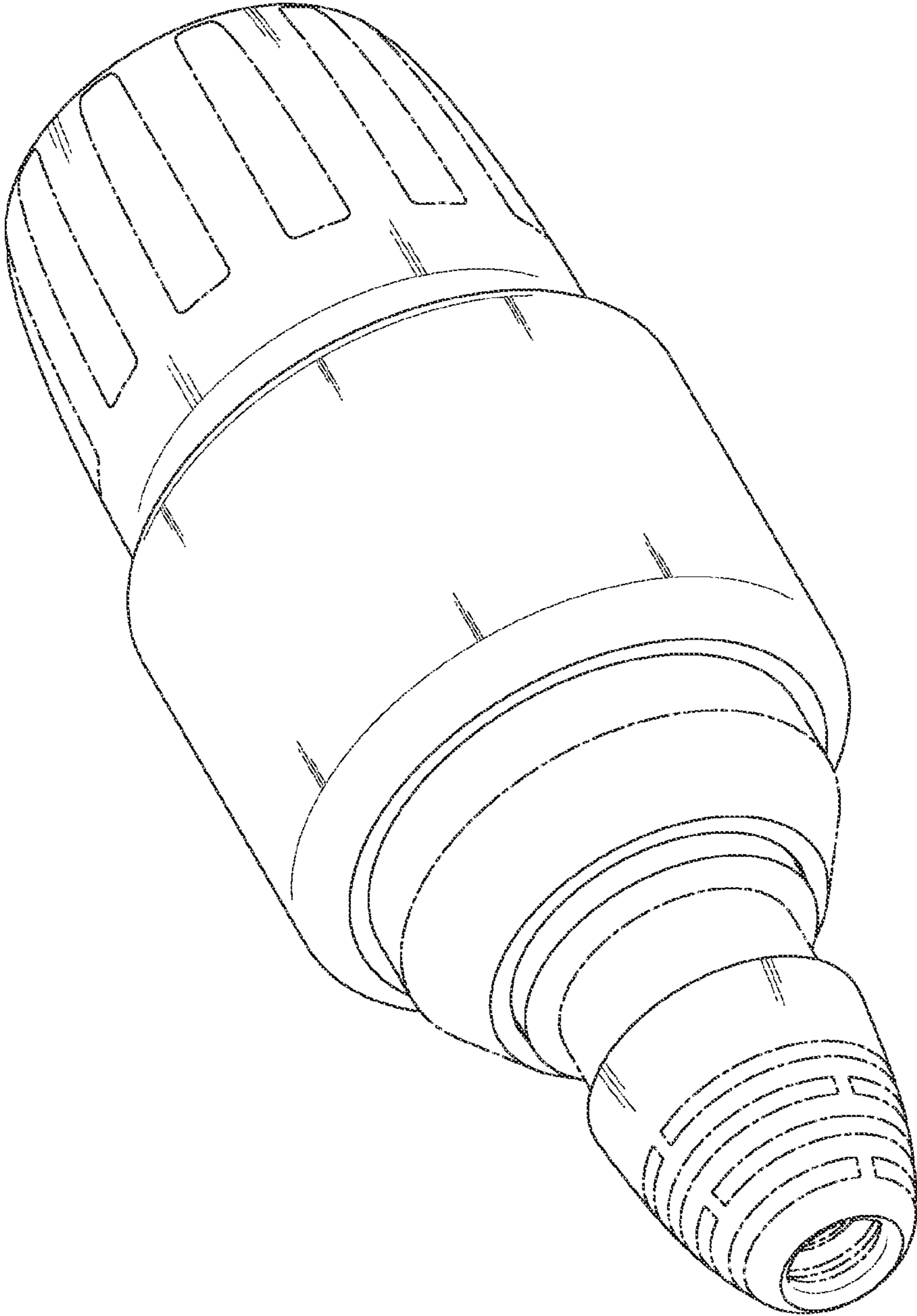

FIG. 1

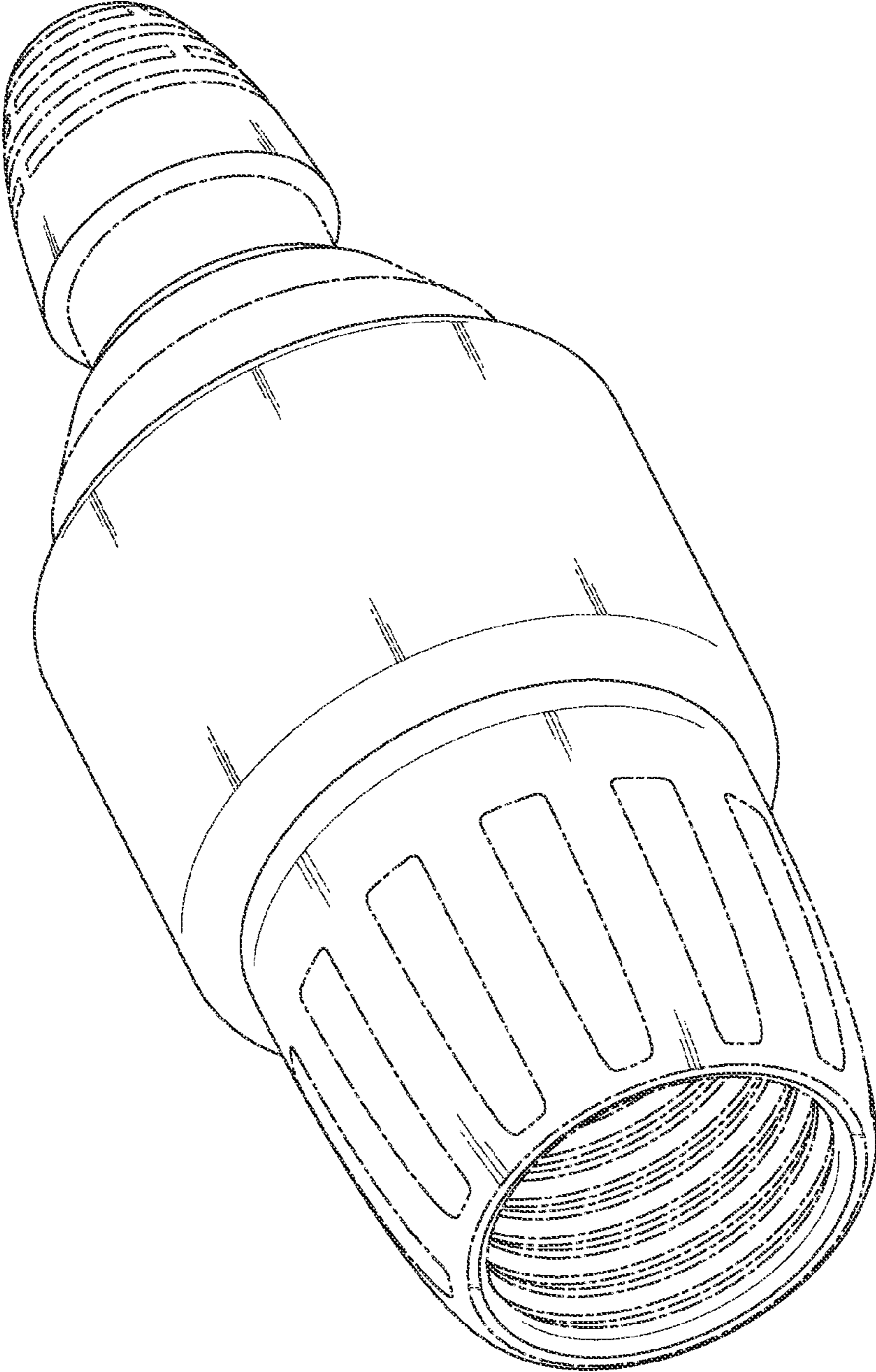

FIG. 2

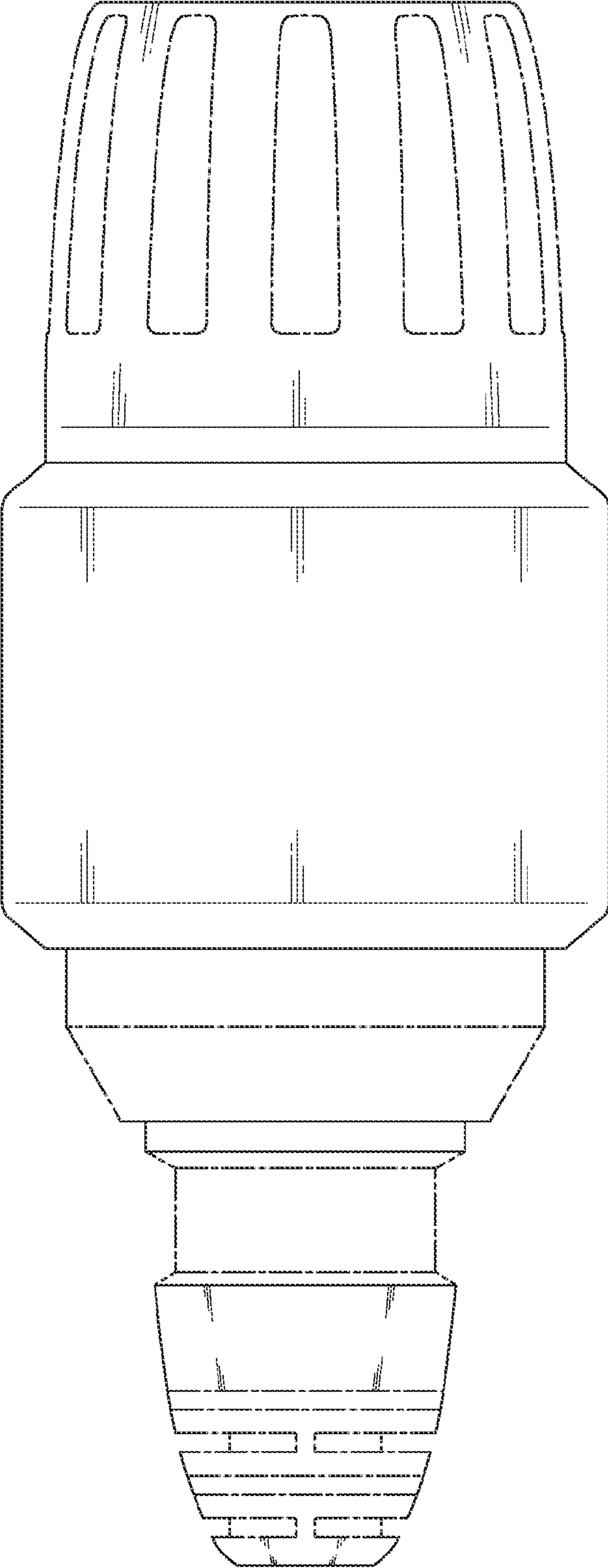

FIG. 3

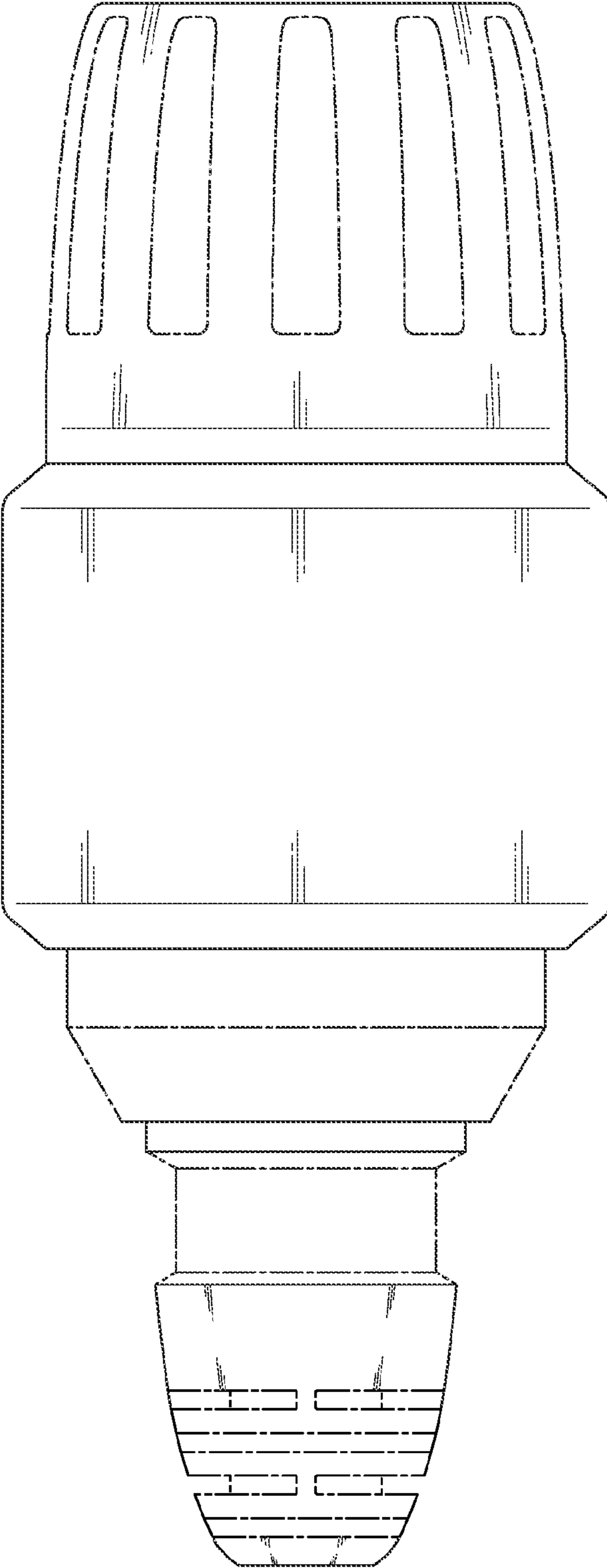

FIG. 4

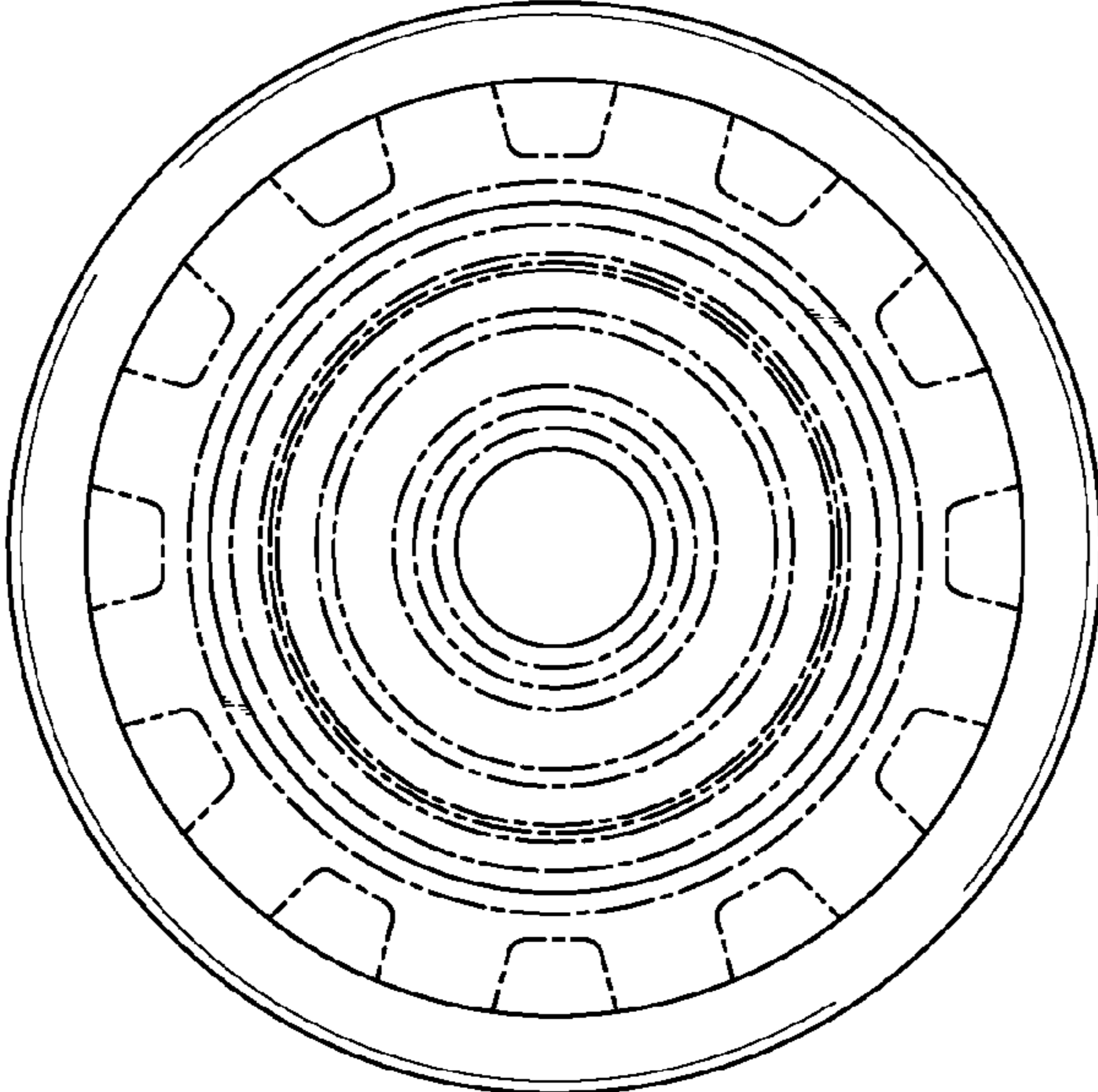

FIG. 6

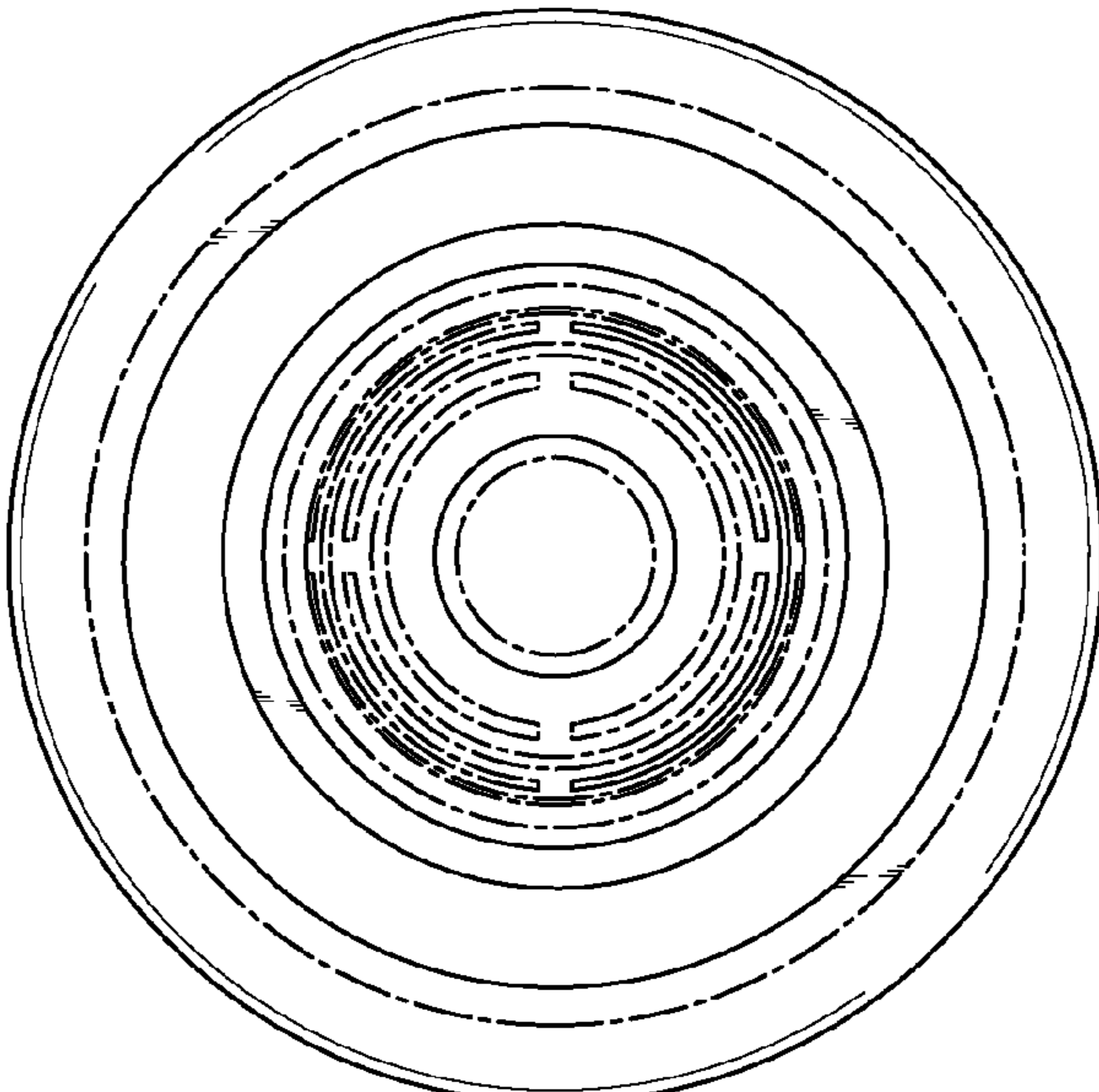

FIG. 5