



US00D646173S

(12) **United States Design Patent**
Venkataraman et al.

(10) **Patent No.:** **US D646,173 S**

(45) **Date of Patent:** **** *Oct. 4, 2011**

(54) **BOTTLE**

(75) Inventors: **Shriram Venkataraman**, Danbury, CT (US); **Kim D. Lufkin**, Auburn, NH (US)

(73) Assignee: **Tropicana Products, Inc.**, Bradenton, FL (US)

(*) Notice: This patent is subject to a terminal disclaimer.

(**) Term: **14 Years**

(21) Appl. No.: **29/359,919**

(22) Filed: **Apr. 16, 2010**

(51) **LOC (9) Cl.** **09-01**

(52) **U.S. Cl.** **D9/541; D9/542**

(58) **Field of Classification Search** D9/516, D9/522, 530, 538, 541, 542, 563, 564, 569, D9/570, 572-574; 215/381-385; 220/600, 220/602, 608, 660, 662, 669, 675
See application file for complete search history.

(56) **References Cited**

U.S. PATENT DOCUMENTS

D48,140 S *	11/1915	Wolfson	D9/542
D240,968 S *	8/1976	Hurst	D24/197
D284,942 S *	8/1986	Dinand	D9/542
D416,199 S *	11/1999	Alguire et al.	D9/542
D503,625 S	4/2005	Nelson et al.		
D509,740 S	9/2005	Collins et al.		
D509,741 S	9/2005	Collins et al.		
D510,026 S	9/2005	Nelson et al.		
D512,322 S	12/2005	Collins et al.		
D512,323 S	12/2005	Collins et al.		
D551,983 S *	10/2007	Barbagli	D9/535
D561,033 S	2/2008	Pritchett, Jr. et al.		
D561,038 S	2/2008	Yourist et al.		
D562,146 S	2/2008	Zboch et al.		
D563,793 S *	3/2008	Nomoto	D9/542
D569,257 S	5/2008	Yourist et al.		

D569,258 S	5/2008	Yourist et al.		
D573,883 S	7/2008	Zboch et al.		
D585,752 S *	2/2009	Shami	D9/530
D598,772 S *	8/2009	Yourist et al.	D9/541
D598,773 S *	8/2009	Yourist et al.	D9/541
D608,210 S *	1/2010	Kuzma et al.	D9/542
D608,648 S *	1/2010	Rhodes et al.	D9/529
D609,576 S *	2/2010	Kuzma et al.	D9/570

* cited by examiner

Primary Examiner — Stella Reid

Assistant Examiner — Keli L Hill

(74) *Attorney, Agent, or Firm* — Banner & Witcoff, Ltd.

(57) **CLAIM**

The ornamental design for a bottle, as shown and described.

DESCRIPTION

FIG. 1 is a front, right perspective view of a bottle showing a first embodiment of our new design;
 FIG. 2 is a front view thereof;
 FIG. 3 is a right side view thereof;
 FIG. 4 is a rear view thereof;
 FIG. 5 is a left side view thereof;
 FIG. 6 is a top view thereof;
 FIG. 7 is a bottom view thereof;
 FIG. 8 is a front, right perspective view of a bottle showing a second embodiment of our new design;
 FIG. 9 is a front view thereof;
 FIG. 10 is a right side view thereof;
 FIG. 11 is a rear view thereof;
 FIG. 12 is a left side view thereof;
 FIG. 13 is a top view thereof; and,
 FIG. 14 is a bottom view thereof.

The dot-dash broken lines immediately adjacent the shaded areas represent the bounds of the claimed design while all other broken lines are included for the purpose of illustrating the unclaimed portions of the article; the broken lines form no part of the claimed design.

1 Claim, 12 Drawing Sheets

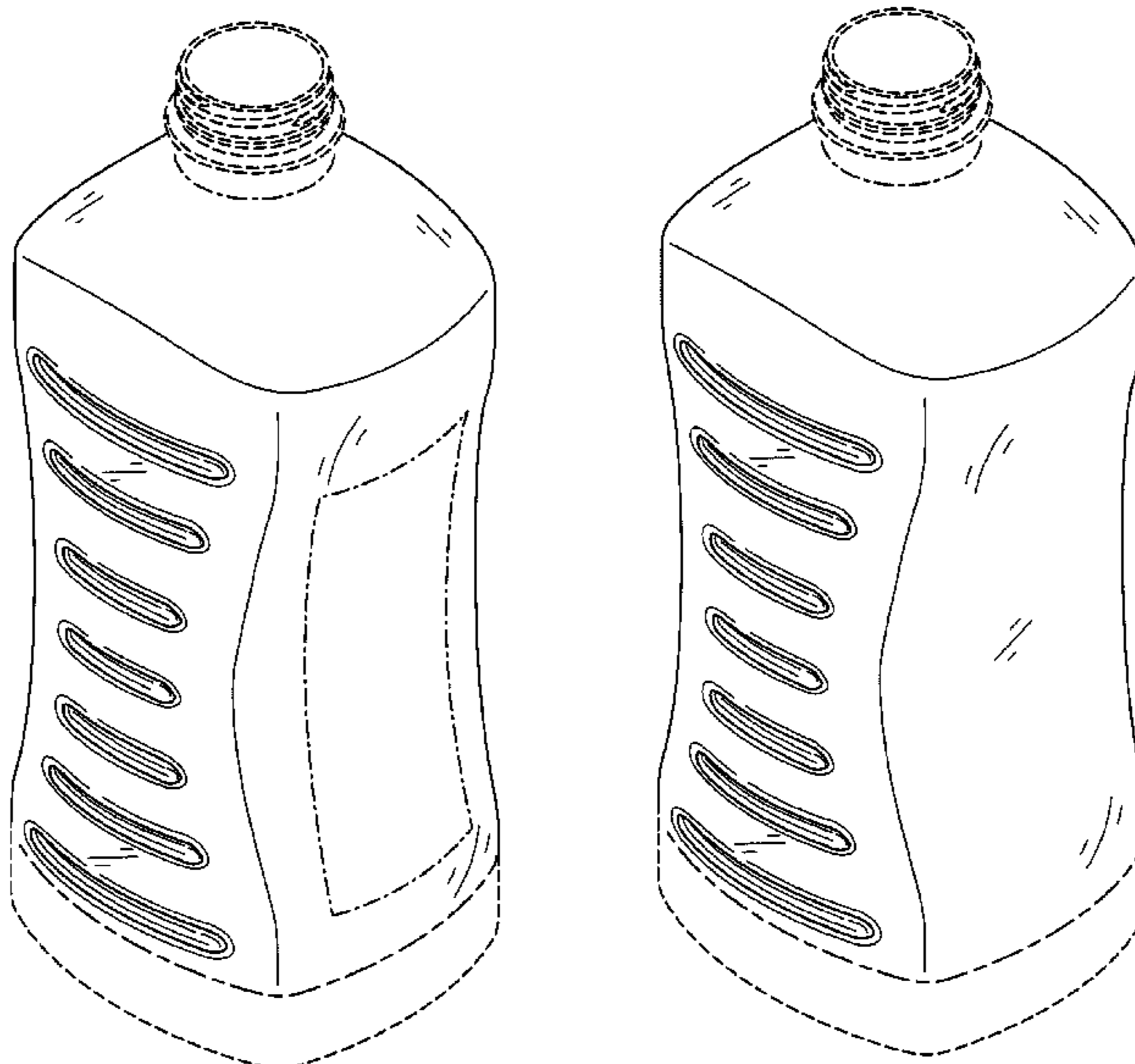

FIG. 1

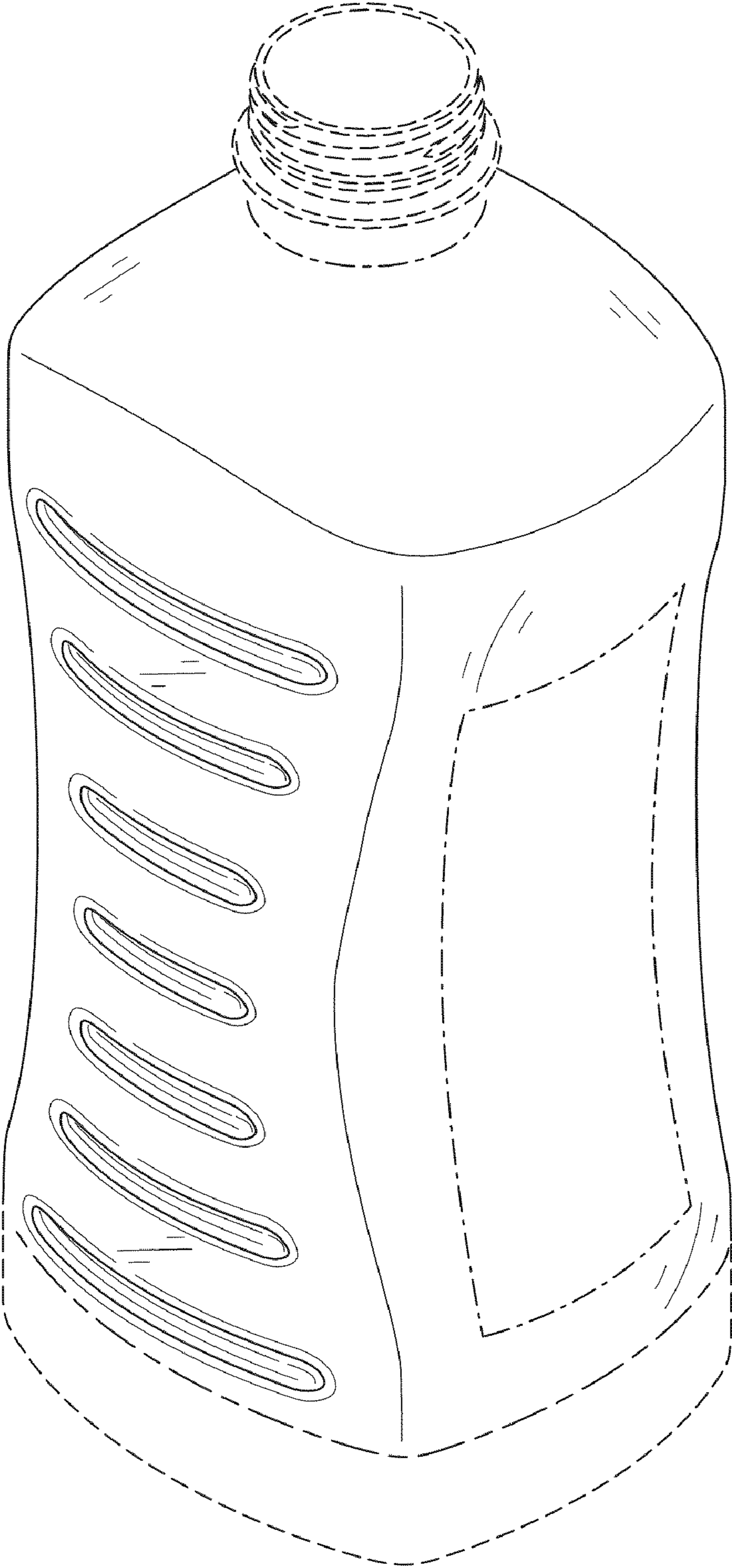

FIG. 2

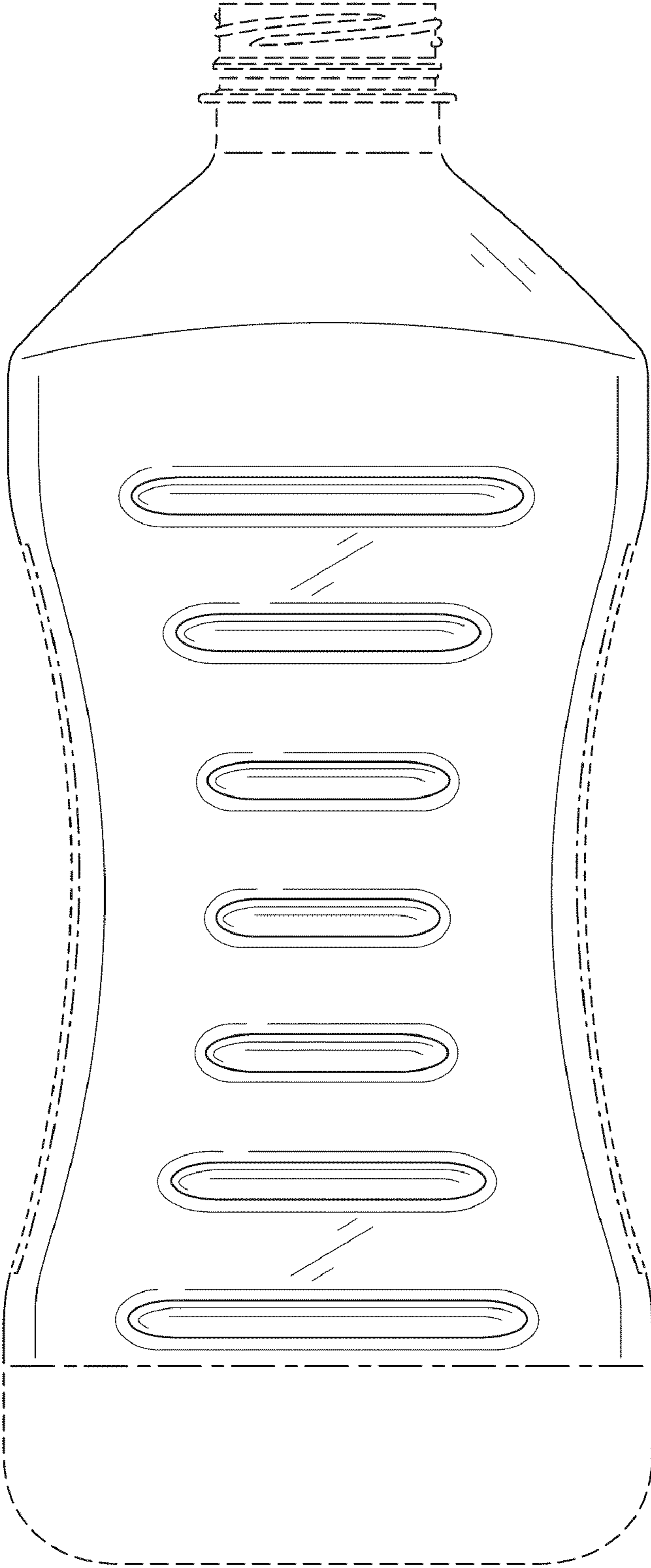

FIG. 3

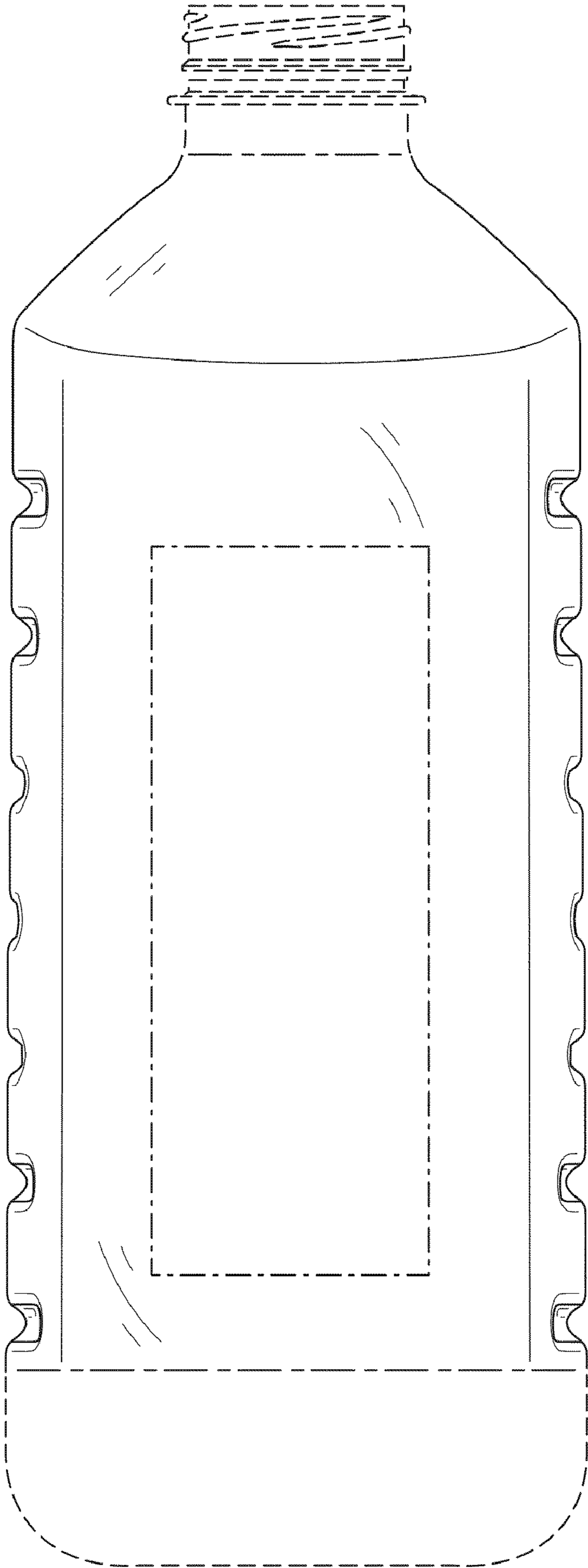

FIG. 4

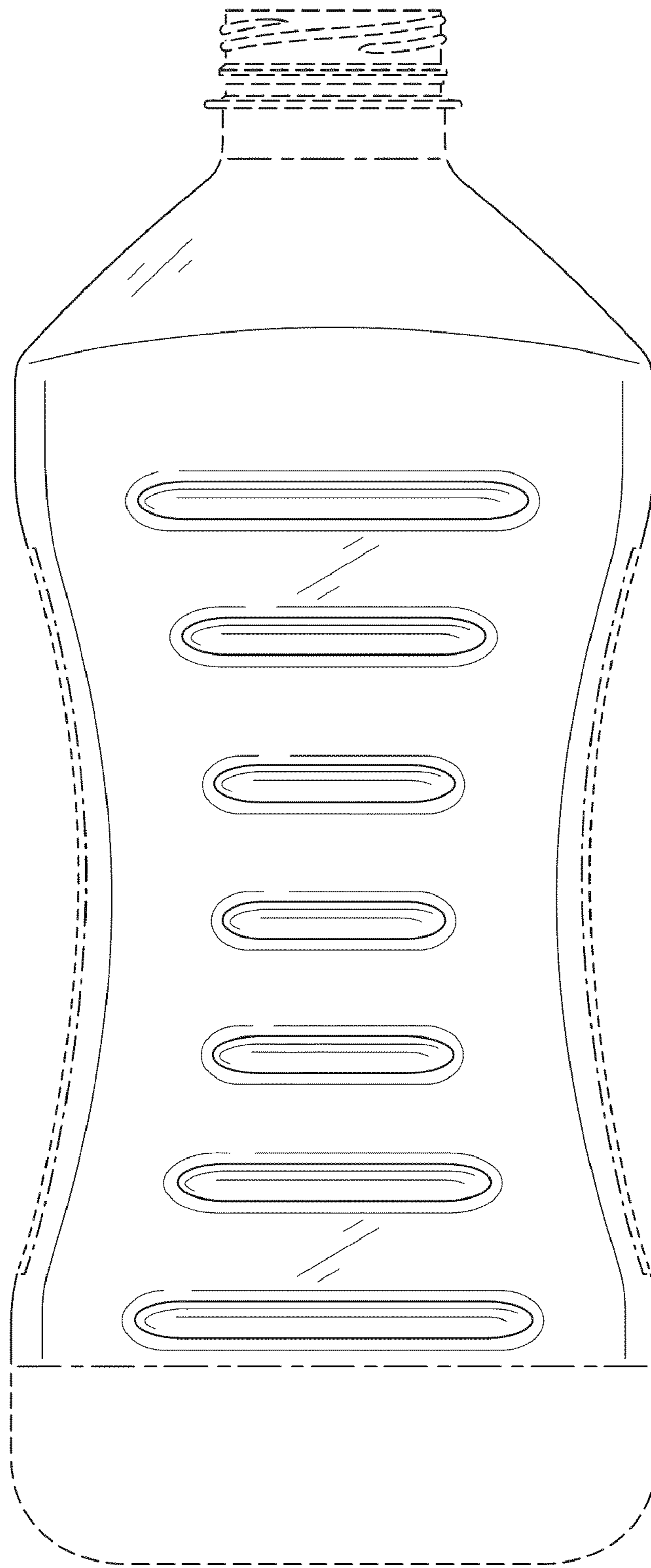

FIG. 5

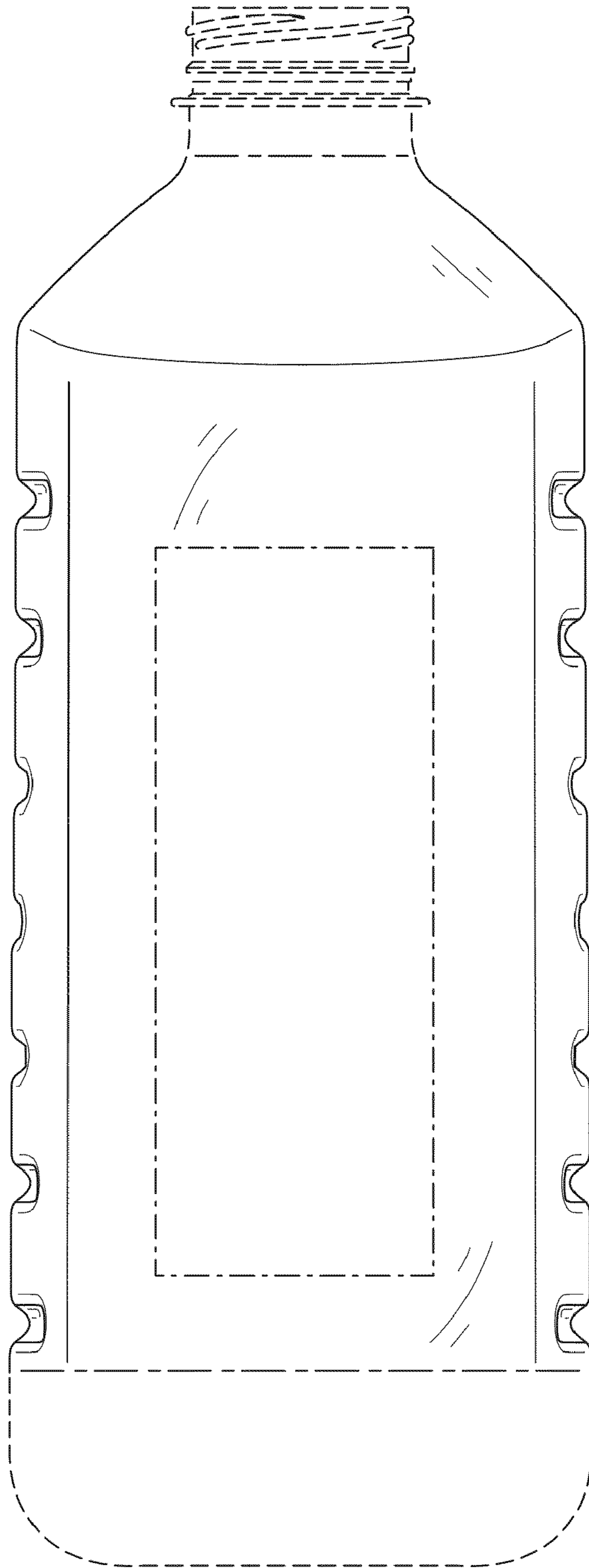

FIG. 6

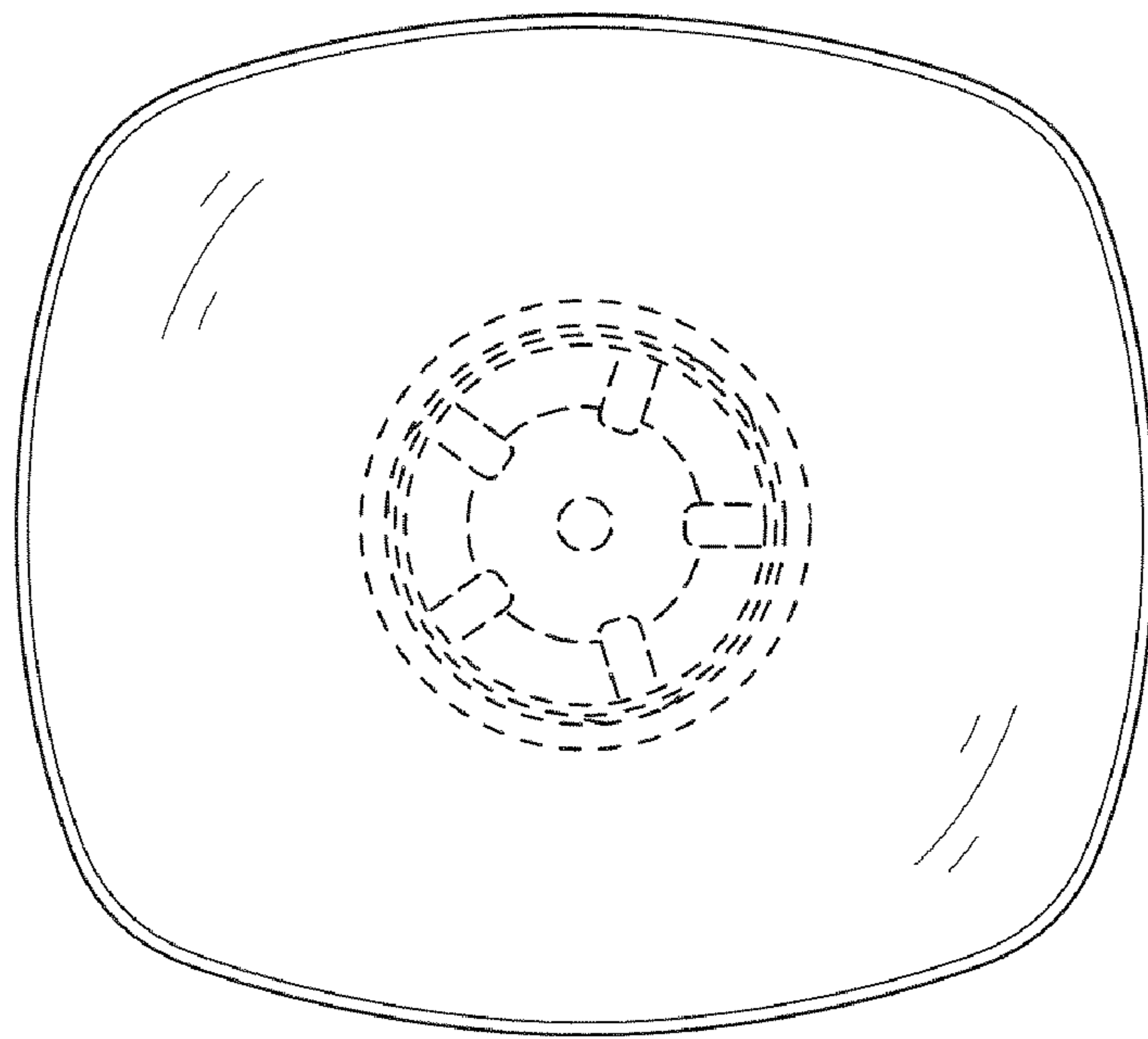

FIG. 7

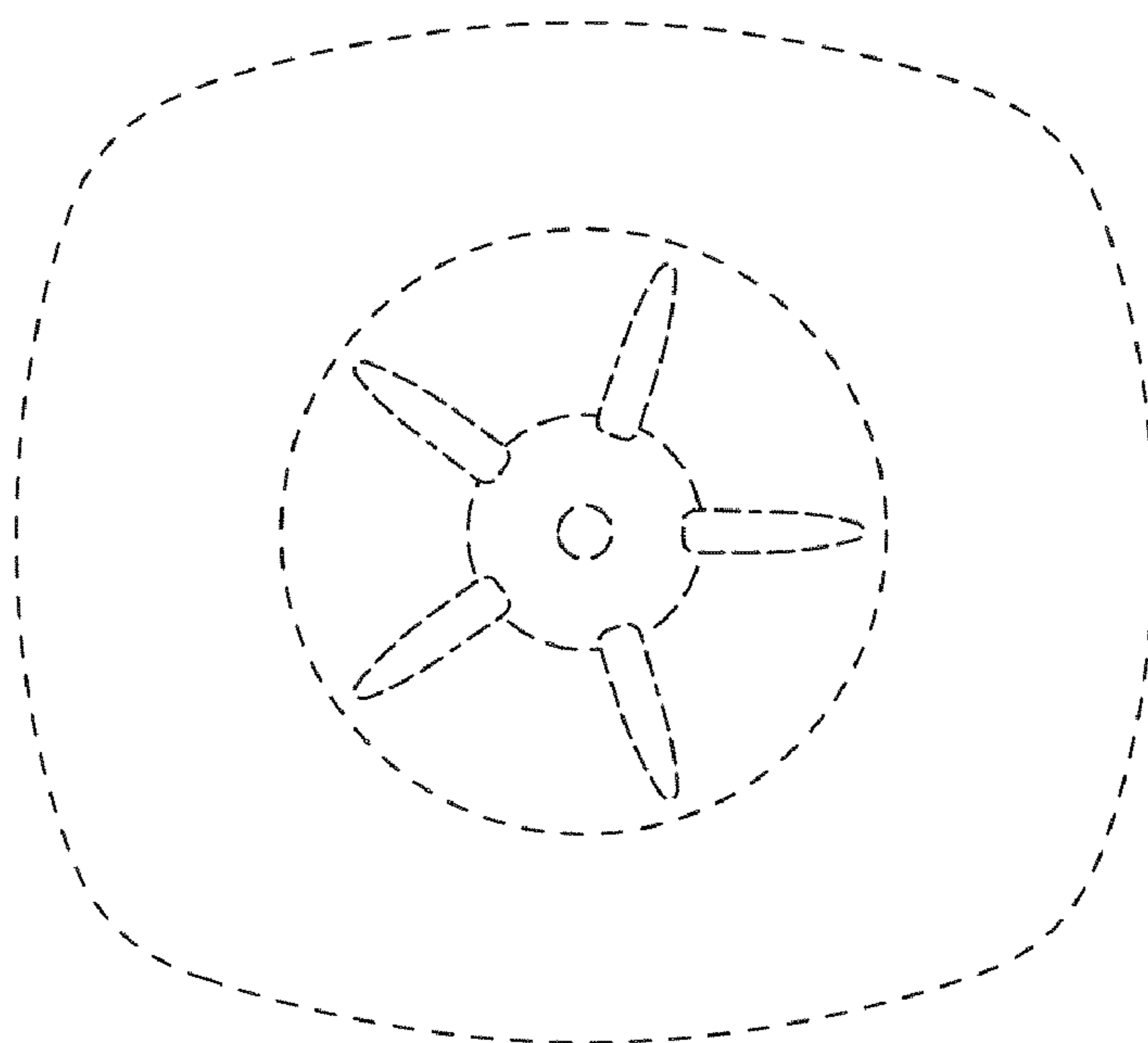

FIG. 8

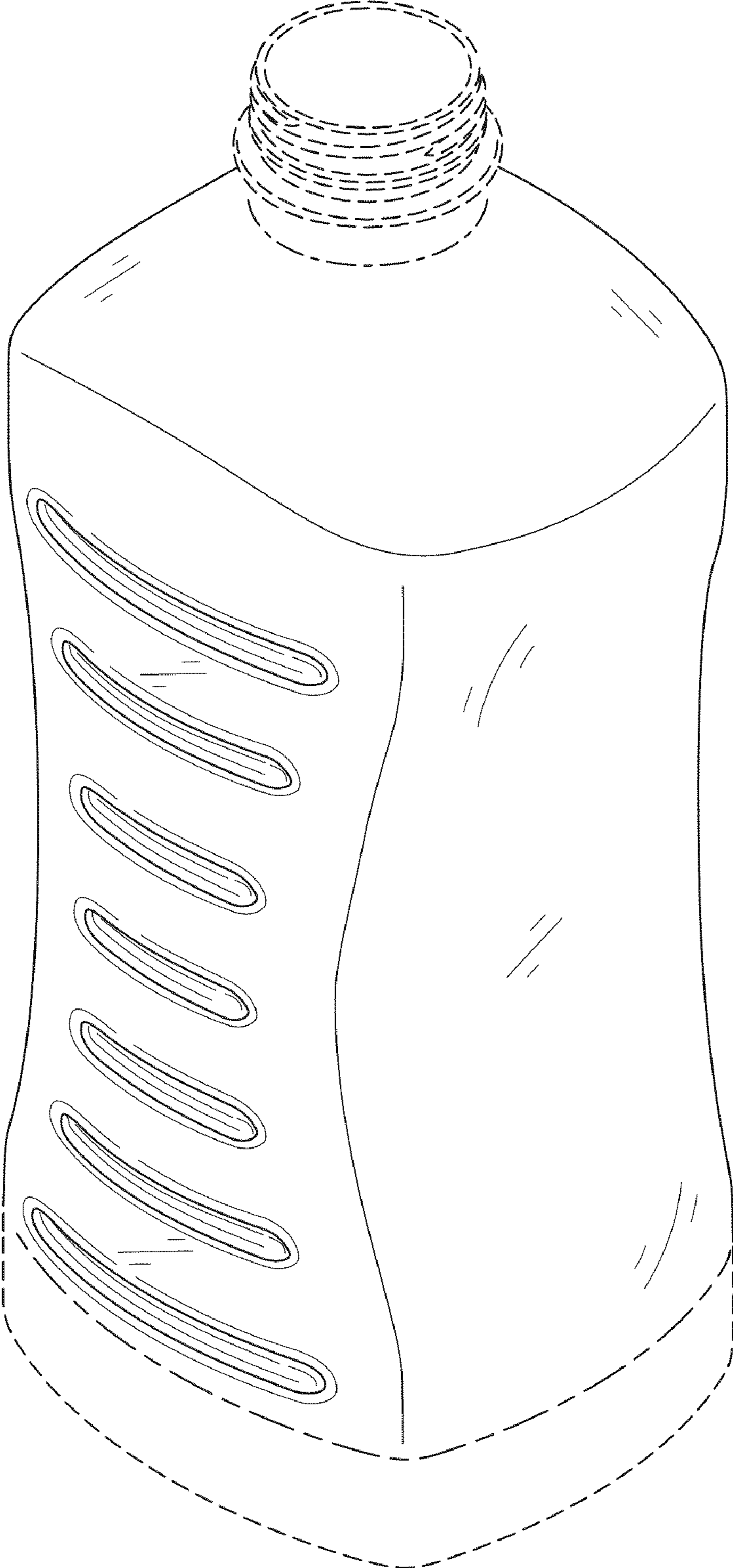

FIG. 9

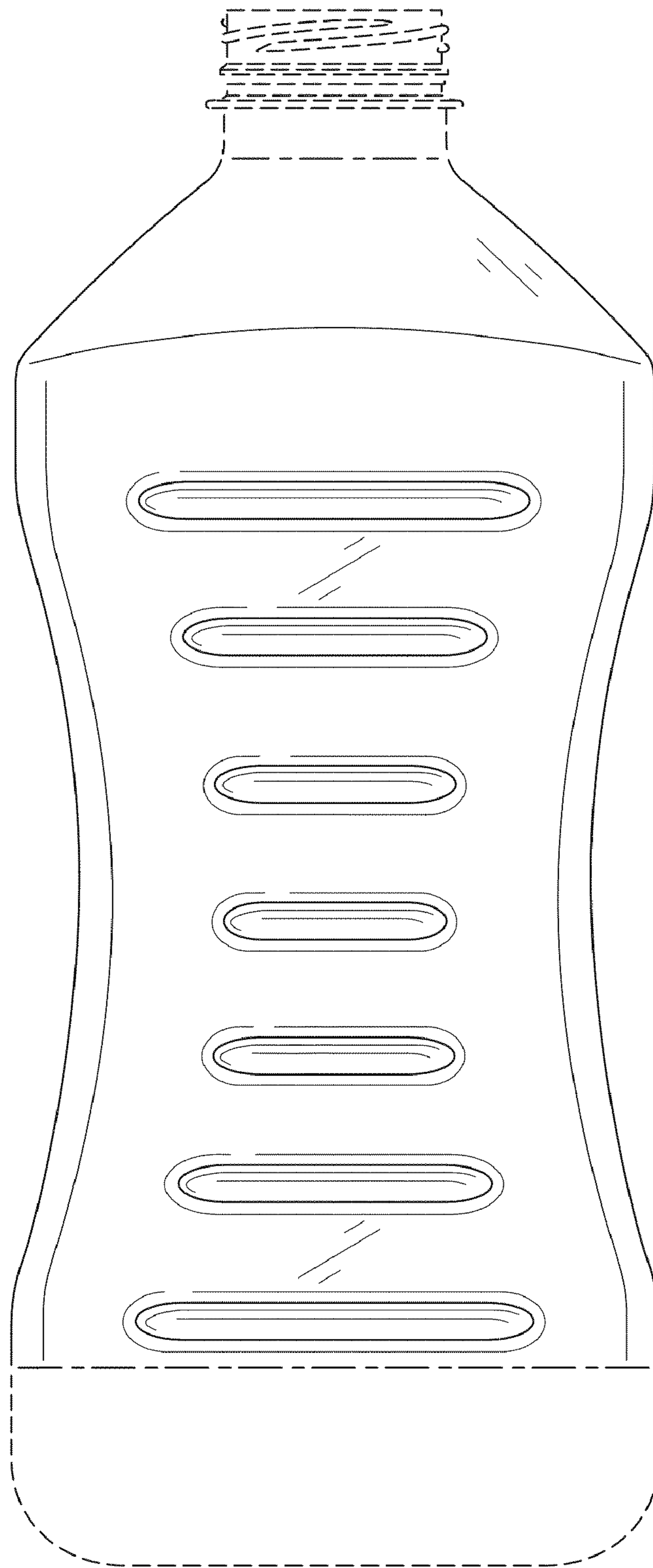

FIG. 10

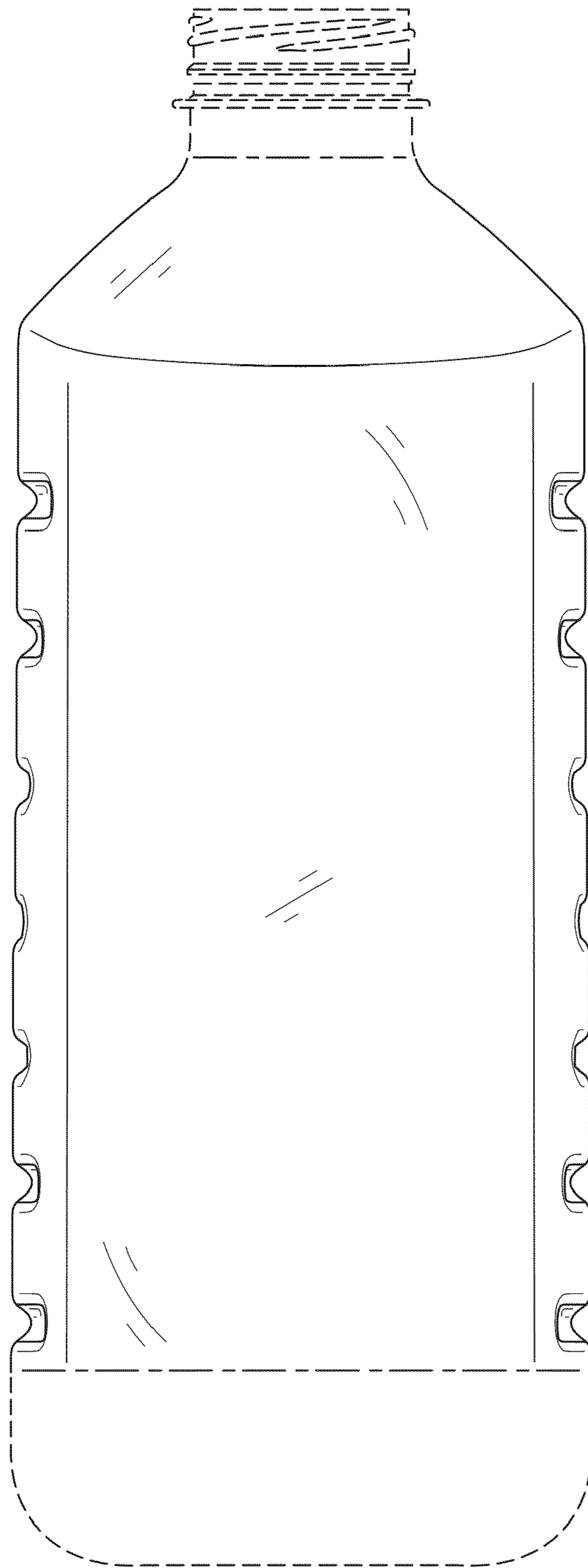

FIG. 11

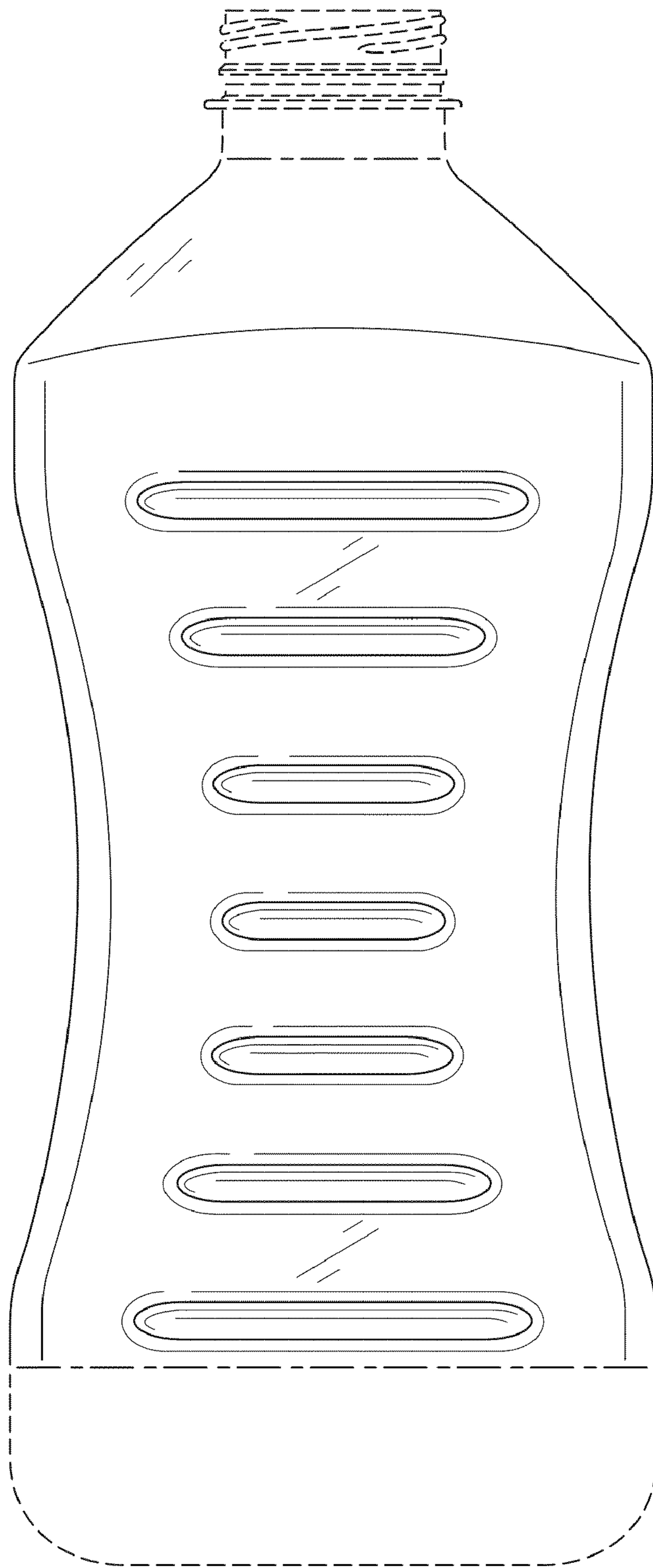

FIG. 12

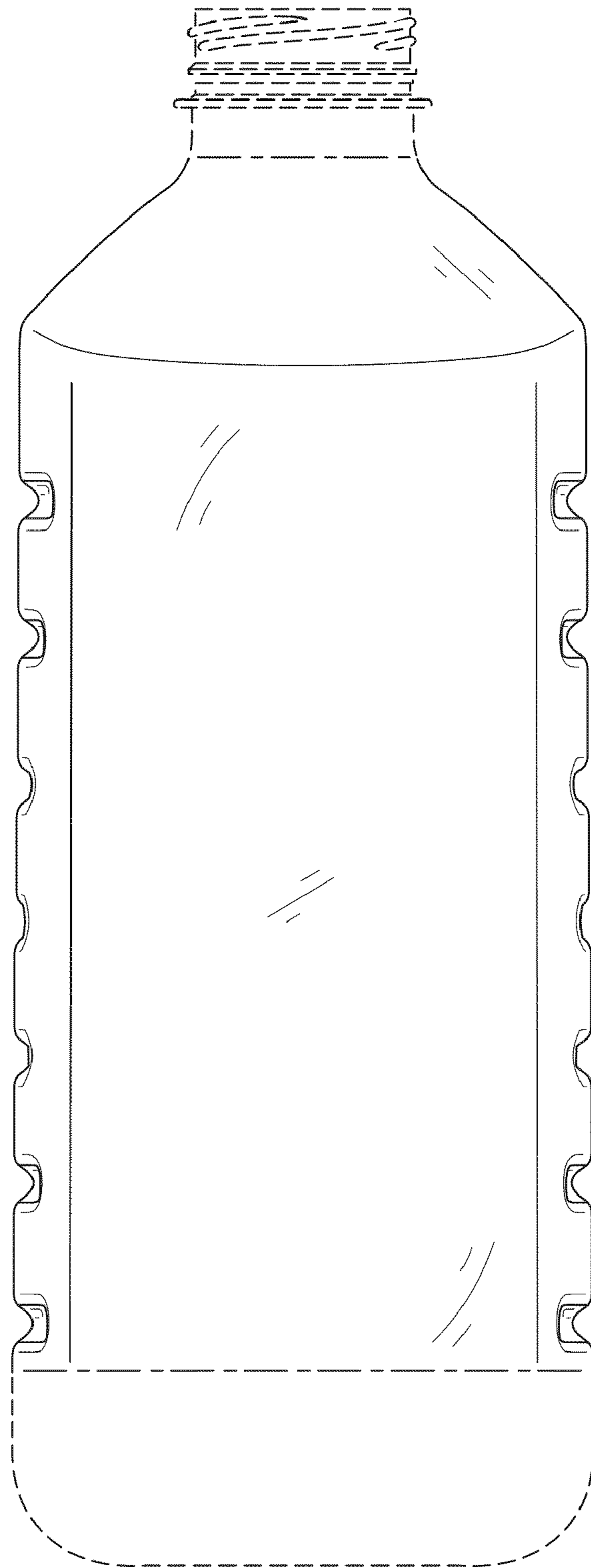

FIG. 13

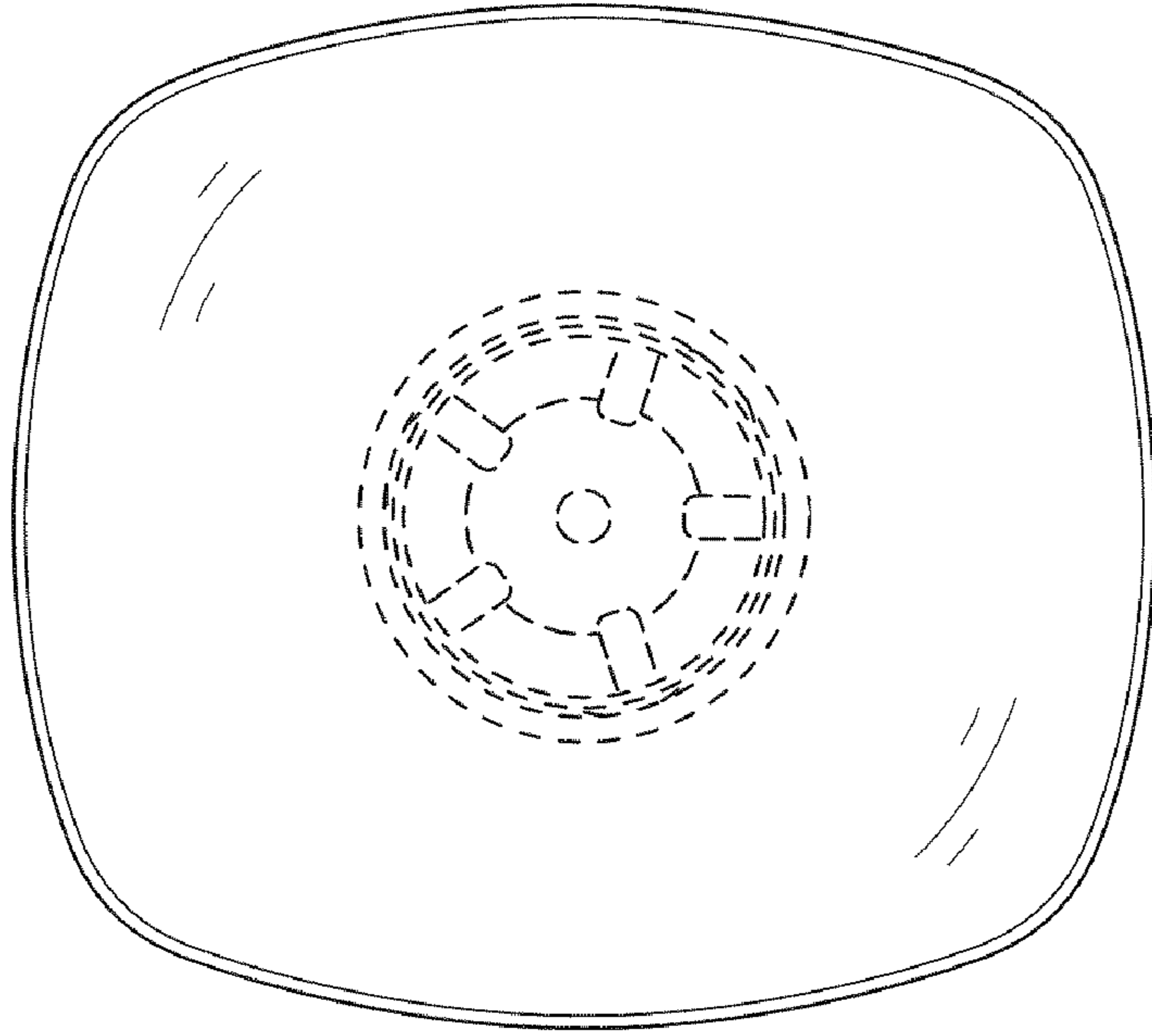

FIG. 14

