



US00D646170S

(12) **United States Design Patent**
Carnduff et al.

(10) **Patent No.:** **US D646,170 S**

(45) **Date of Patent:** **** Oct. 4, 2011**

(54) **CONTAINER FOR HAIR CARE COMPOSITION**

(75) Inventors: **Ian Andrew Carnduff**, New York, NY (US); **Richard Michael Girardot**, West Chester, OH (US); **Adrian Keith McKinney**, Maineville, OH (US); **Patrick John Mulcahy**, Goshen Township, OH (US); **Ian Josiah Swanson**, New York, NY (US); **Cristian Alexis Viola-Prioli**, Loveland, OH (US); **Erika Linsley Wetzel**, Cincinnati, OH (US)

(73) Assignee: **The Procter & Gamble Company**, Cincinnati, OH (US)

(**) Term: **14 Years**

(21) Appl. No.: **29/337,147**

(22) Filed: **May 15, 2009**

(51) **LOC (9) Cl.** **09-01**

(52) **U.S. Cl.** **D9/521; D9/522; D9/565; D9/575; D9/449**

(58) **Field of Classification Search** D9/686-687, D9/693-694, 521, 529, 537-543, 549, 572, D9/575, 446-447, 449; 220/660, 662, 669, 220/675

See application file for complete search history.

(56) **References Cited**

U.S. PATENT DOCUMENTS

D328,246 S *	7/1992	Nottingham et al.	D9/549 X
D373,536 S *	9/1996	Kokenge et al.	D9/529
D387,992 S *	12/1997	Kotoucek	D9/521
D471,820 S *	3/2003	Faillant-Dumas	D9/529
D540,176 S *	4/2007	Flurer et al.	D9/529
D540,685 S *	4/2007	Shurtleff et al.	D9/521
D542,660 S *	5/2007	Thomas et al.	D9/521
D543,115 S *	5/2007	Flurer et al.	D9/529
D548,601 S *	8/2007	Mongeon et al.	D9/529
D561,045 S *	2/2008	Lee	D9/573 X
D575,166 S *	8/2008	Miller et al.	
D578,003 S *	10/2008	Shurtleff et al.	D9/543 X

D580,269 S *	11/2008	Xiao et al.	D9/521
D588,920 S *	3/2009	O'Donahue	D9/521
D591,613 S *	5/2009	Mason	D9/694
D601,425 S *	10/2009	Miller et al.	D9/522
D604,164 S *	11/2009	Miller et al.	D9/575 X
D615,412 S *	5/2010	Thomas et al.	D9/529
D623,527 S *	9/2010	Wykoff	D9/575 X
D624,424 S *	9/2010	Fiore et al.	D9/521
D632,577 S *	2/2011	Drake et al.	D9/575 X
D632,970 S *	2/2011	Drake et al.	D9/558

OTHER PUBLICATIONS

U.S. Appl. No. 29/337,146, filed May 15, 2009, Carnduff et al.

* cited by examiner

Primary Examiner — Carol P Rademaker

(74) *Attorney, Agent, or Firm* — Laura R. Grunzinger; Angela K. Haughey

(57) **CLAIM**

The ornamental design for a container for hair care composition, as shown and described.

DESCRIPTION

FIG. 1 is a top, front, and right side perspective view of a container for hair care composition showing a first embodiment of our new design;

FIG. 2 is a front elevational view thereof;

FIG. 3 is a back elevational view thereof;

FIG. 4 is a right side elevational view thereof;

FIG. 5 is a left side elevational view thereof;

FIG. 6 is a top plan view thereof;

FIG. 7 is a bottom plan view thereof;

FIG. 8 is a top, front, and right side perspective view of a container for hair care composition showing a second embodiment of our new design;

FIG. 9 is a front elevational view thereof;

FIG. 10 is a back elevational view thereof;

FIG. 11 is a right side elevational view thereof;

FIG. 12 is a left side elevational view thereof;

FIG. 13 is a top plan view thereof; and,

FIG. 14 is a bottom plan view thereof.

1 Claim, 8 Drawing Sheets

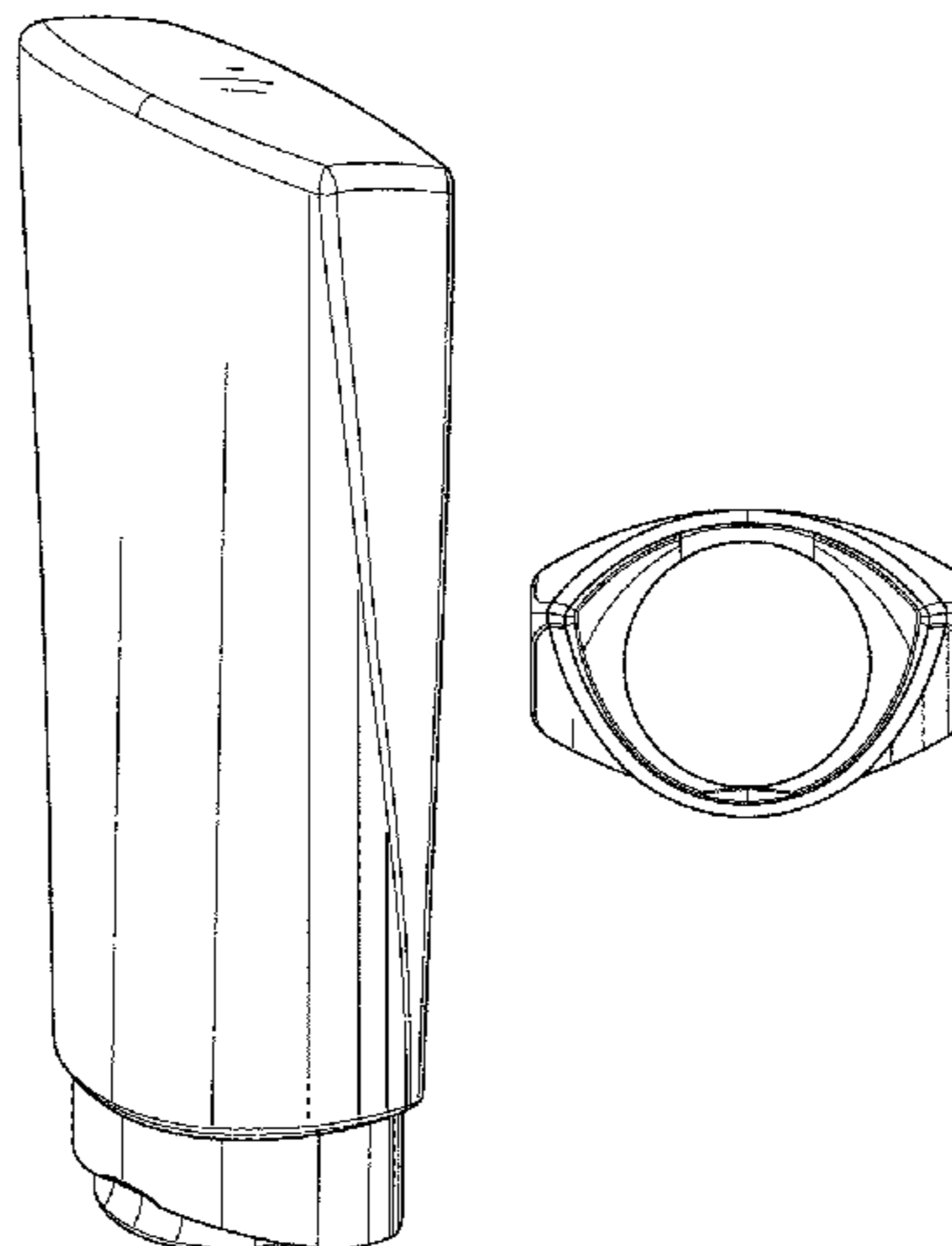

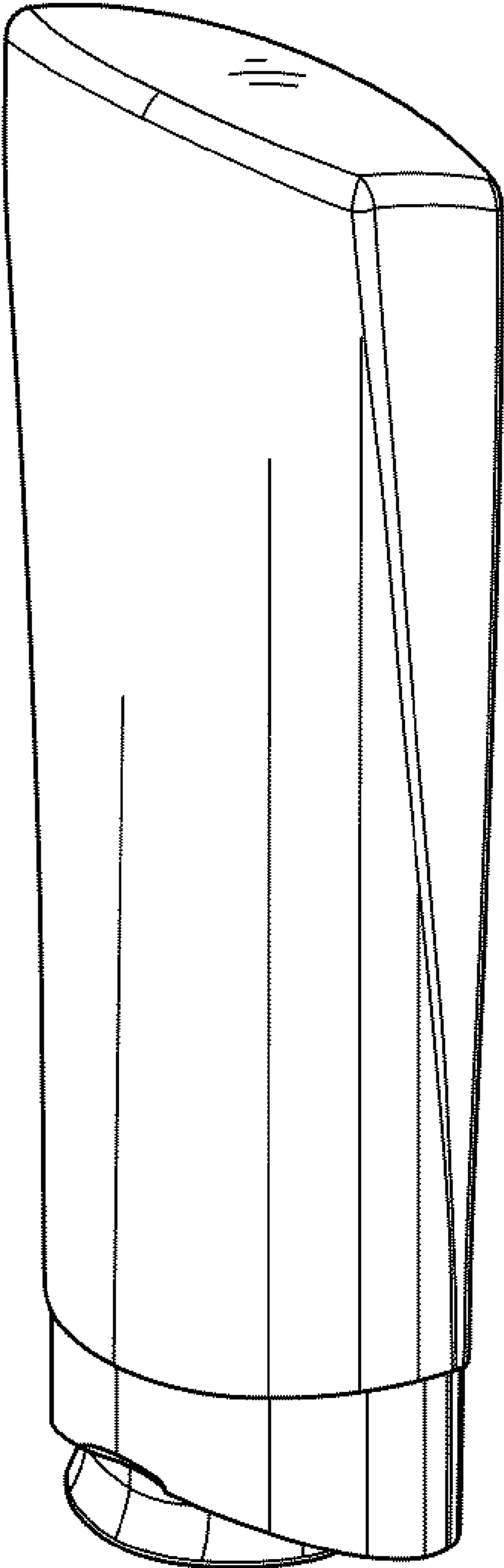

FIG. 1

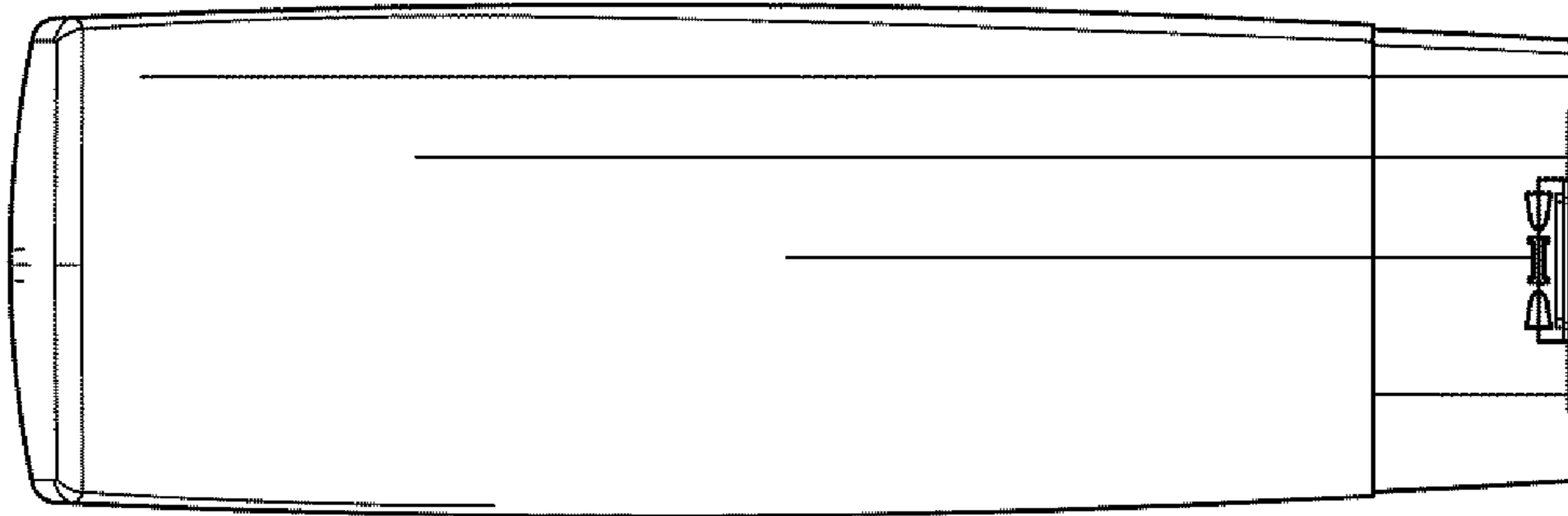

FIG. 3

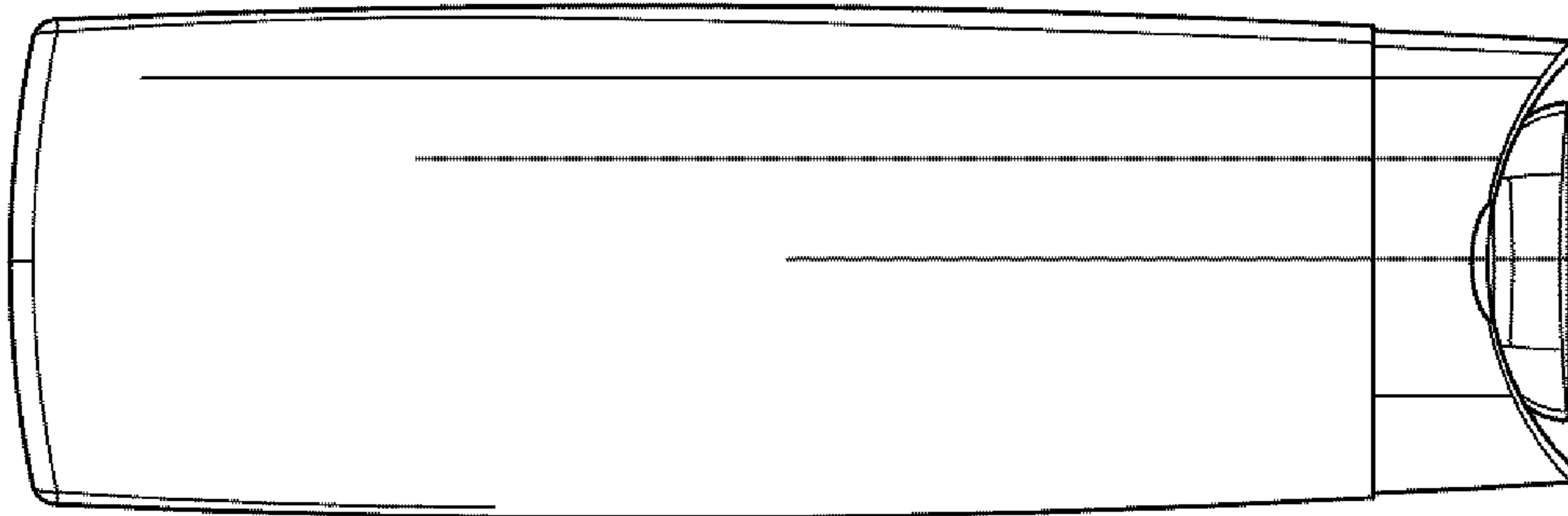

FIG. 2

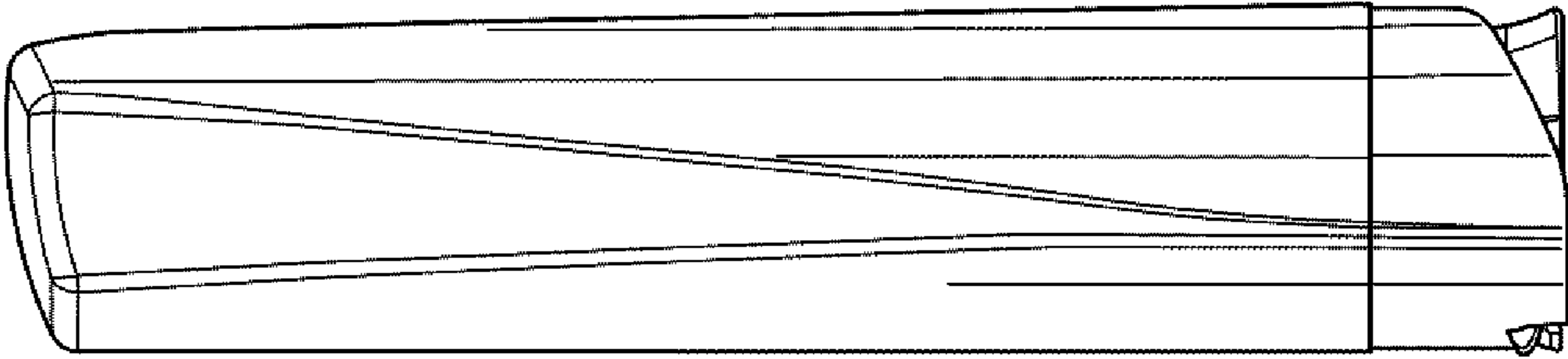

FIG. 5

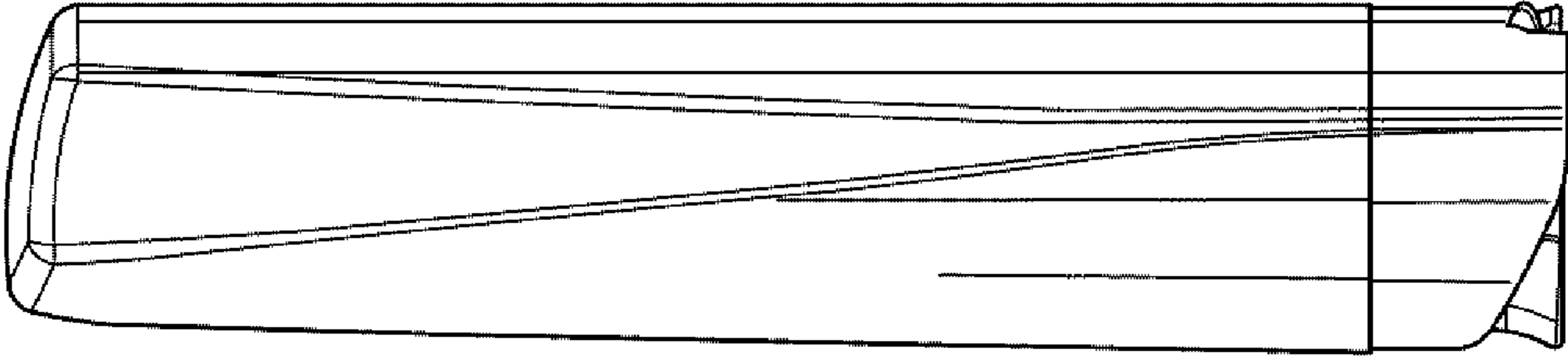

FIG. 4

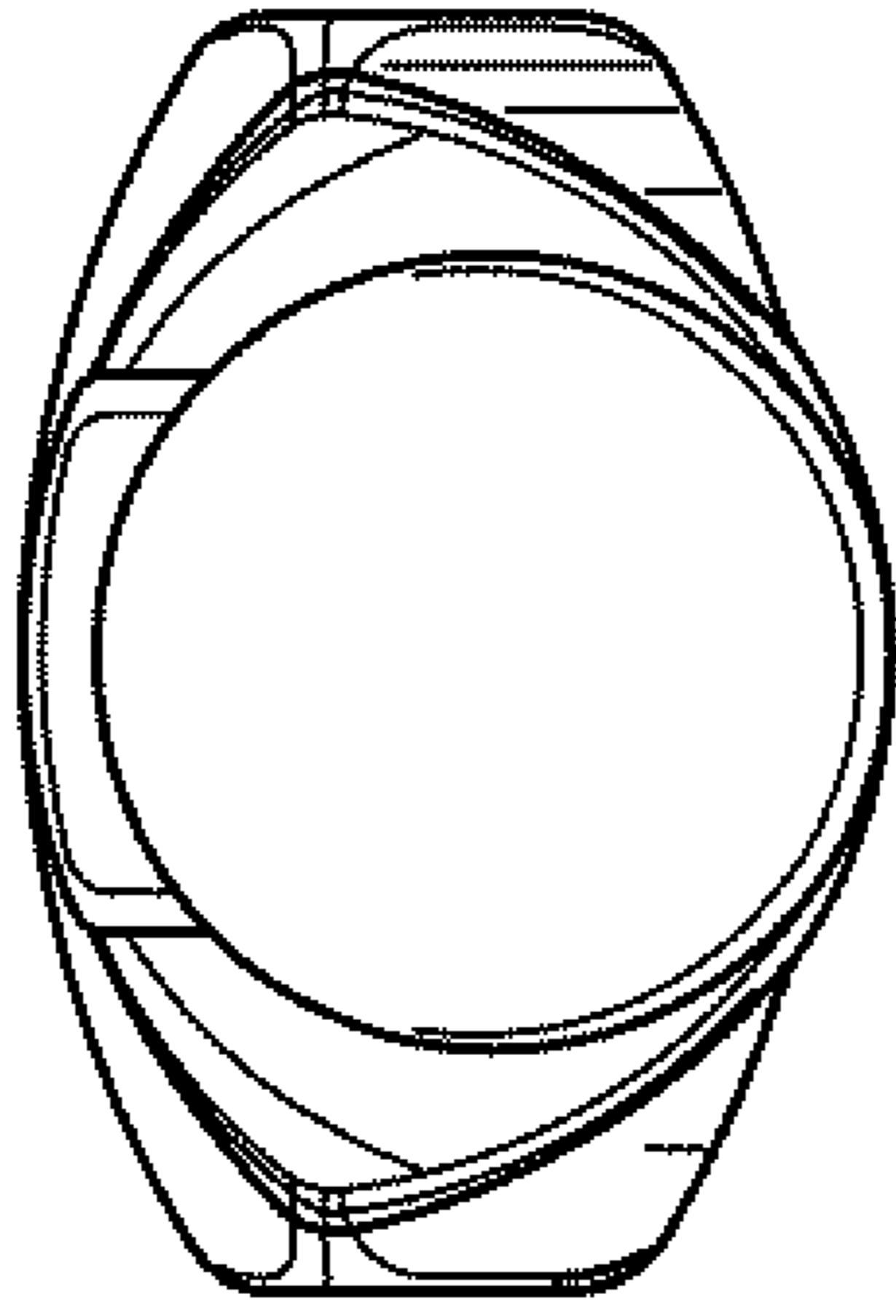

FIG. 7

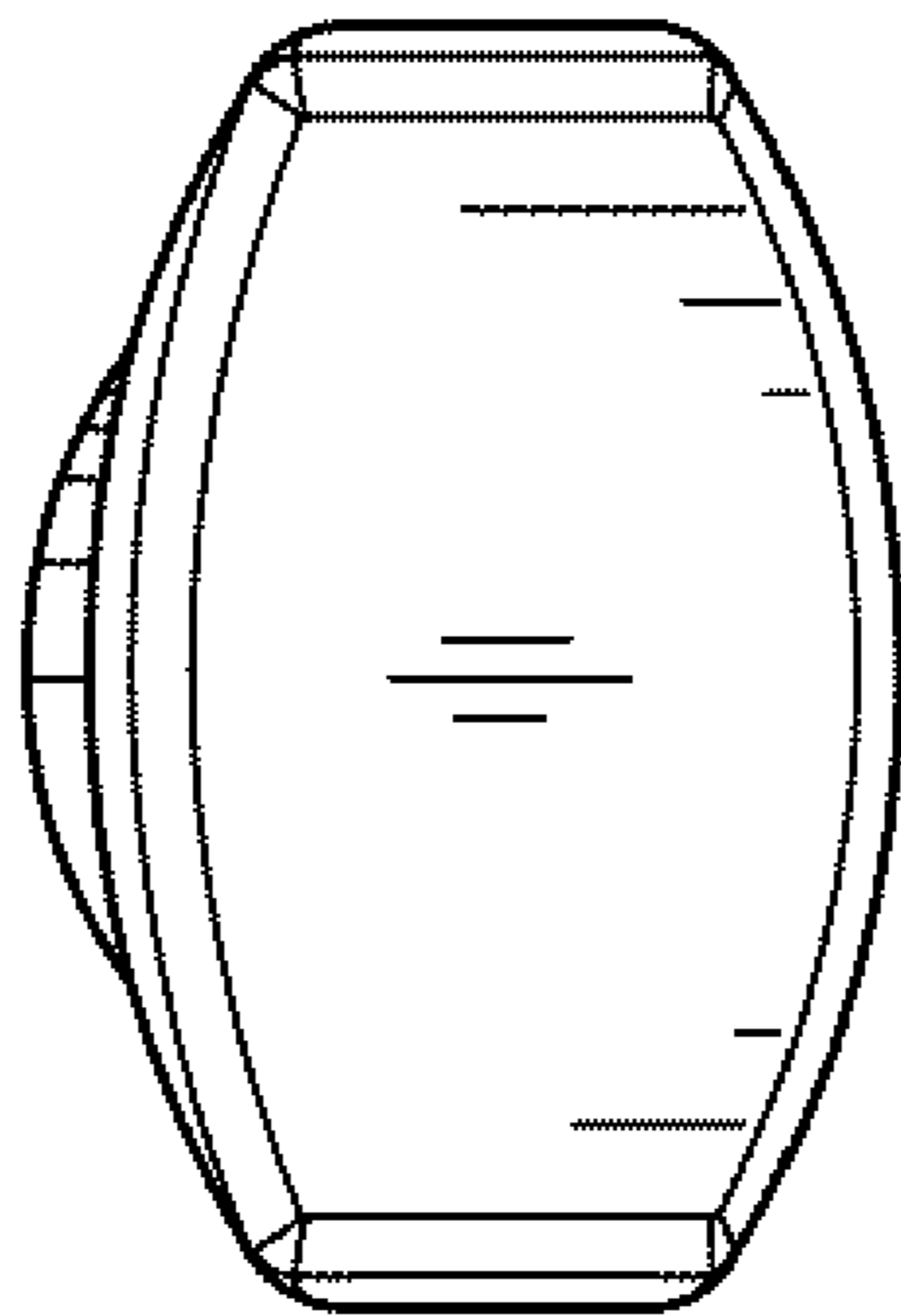

FIG. 6

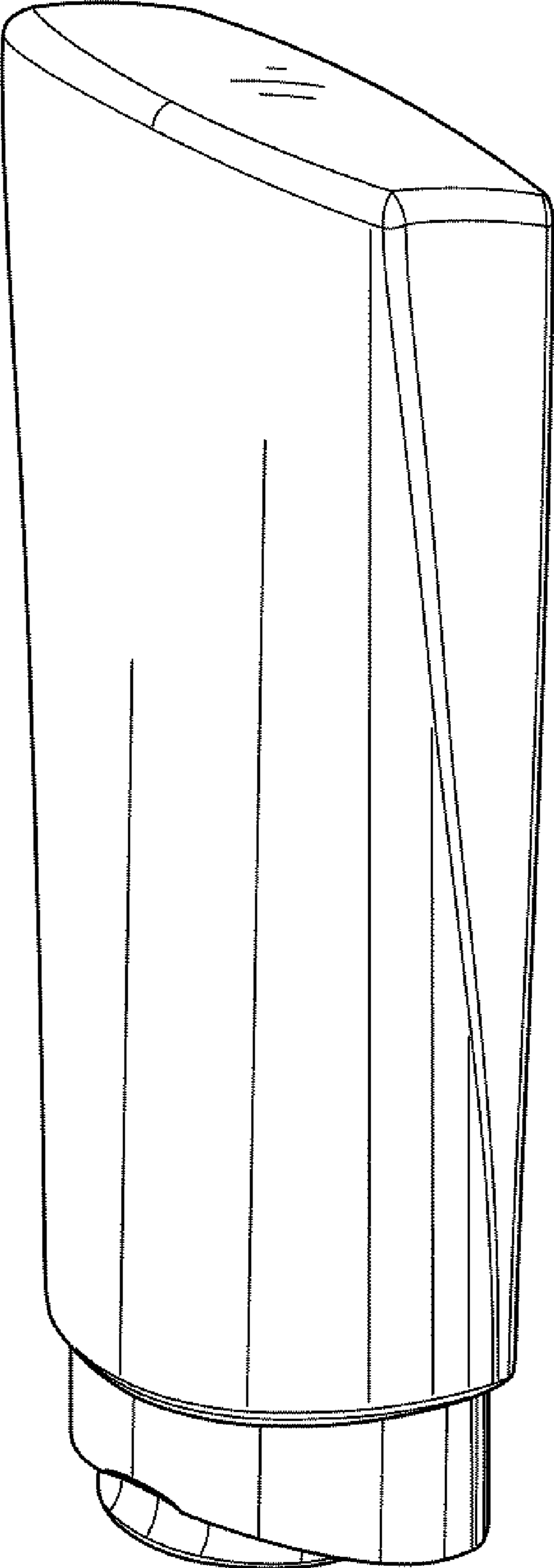

FIG. 8

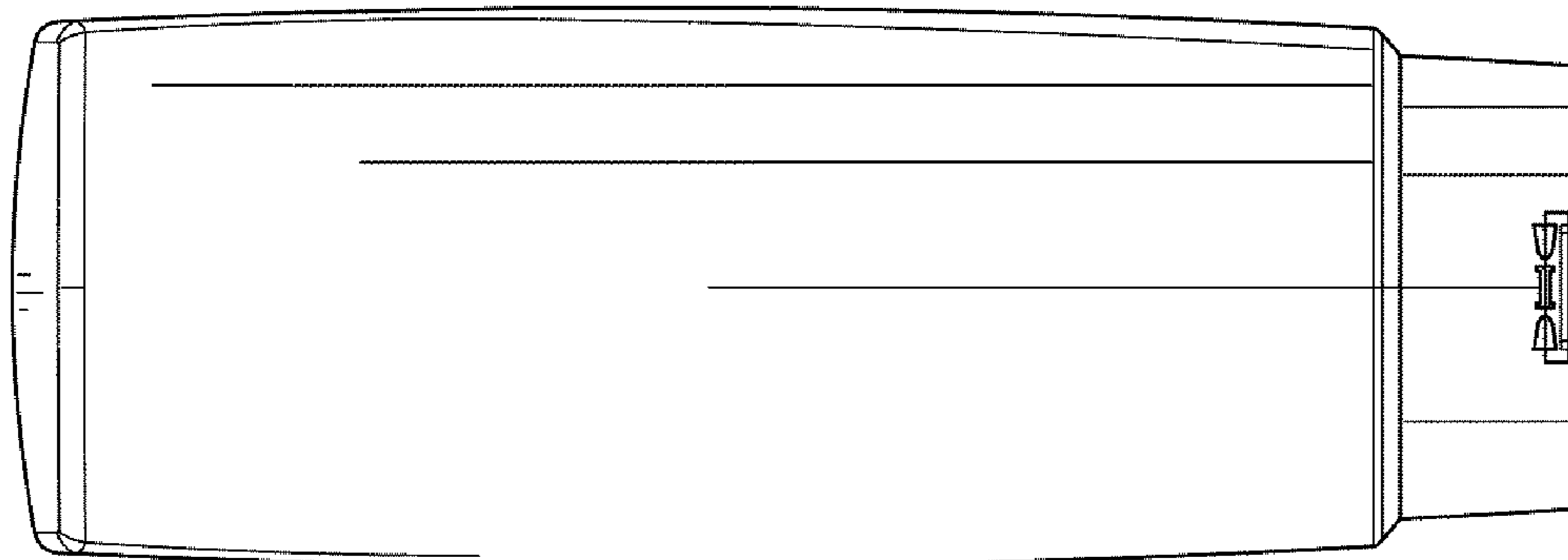

FIG. 10

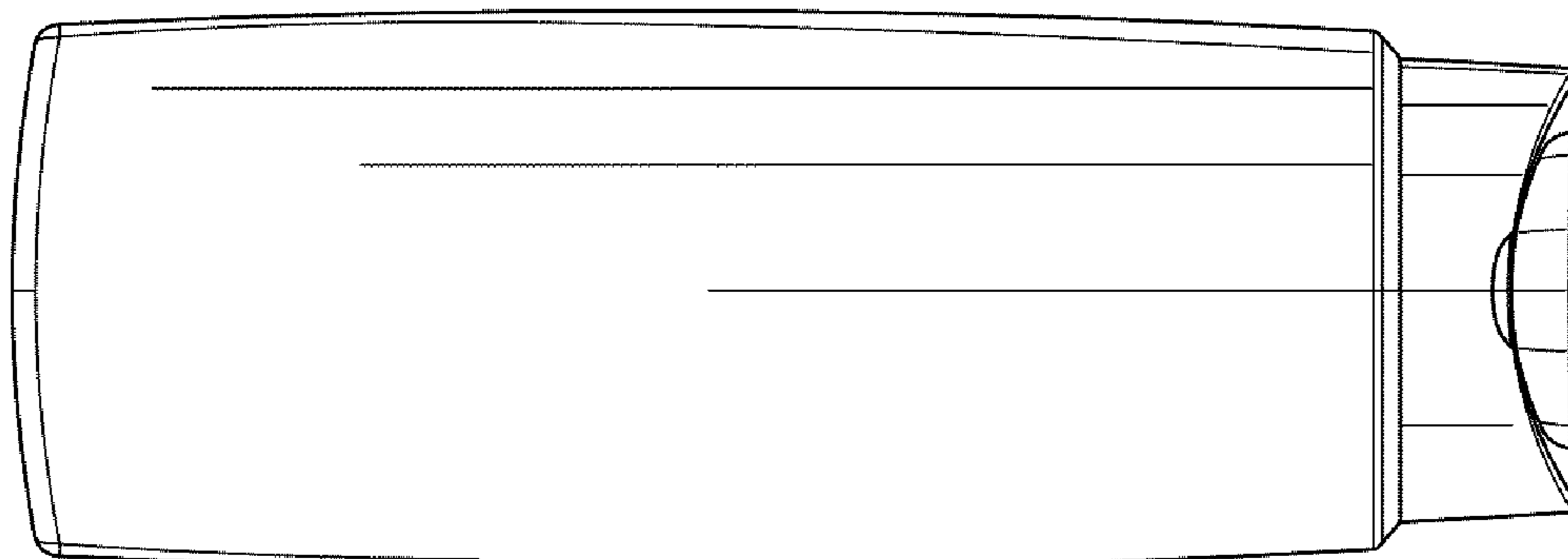

FIG. 9

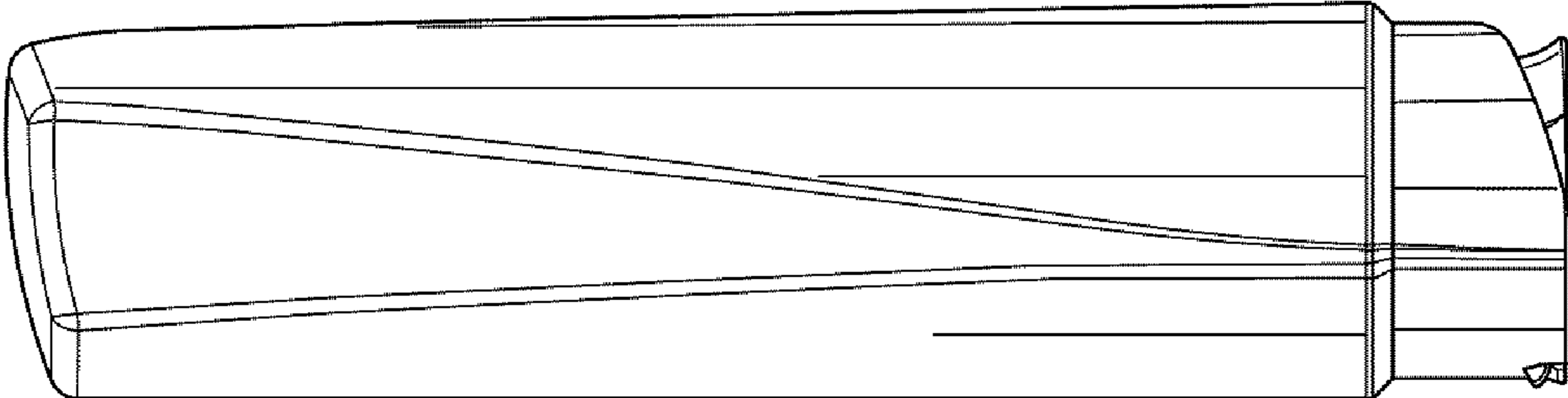

FIG. 12

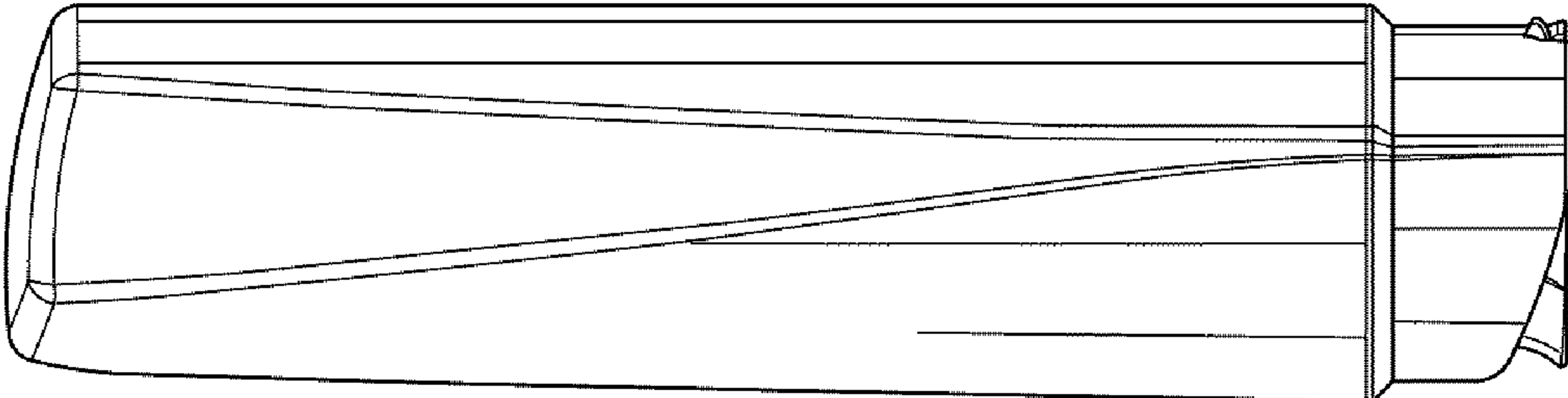

FIG. 11

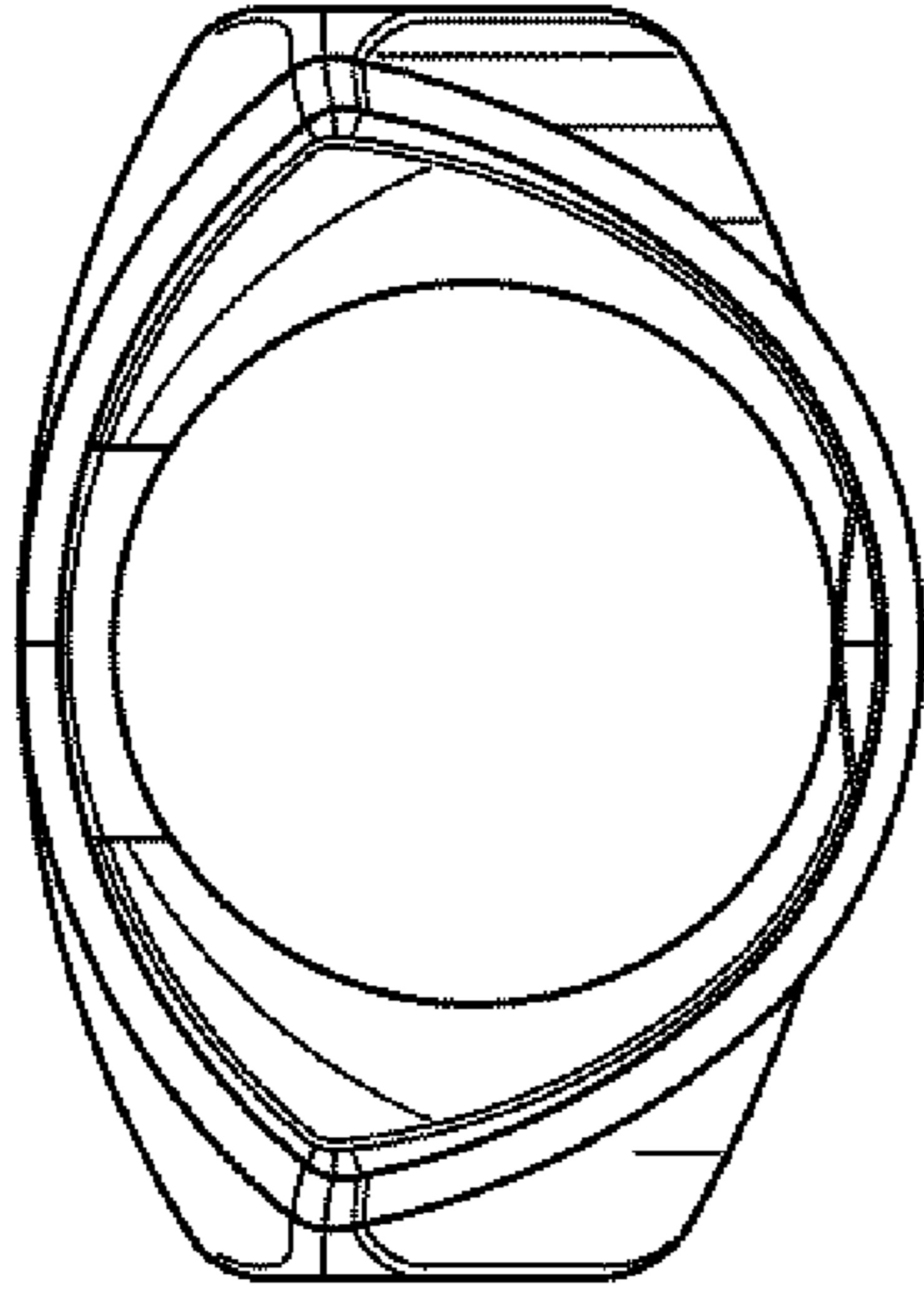

FIG. 14

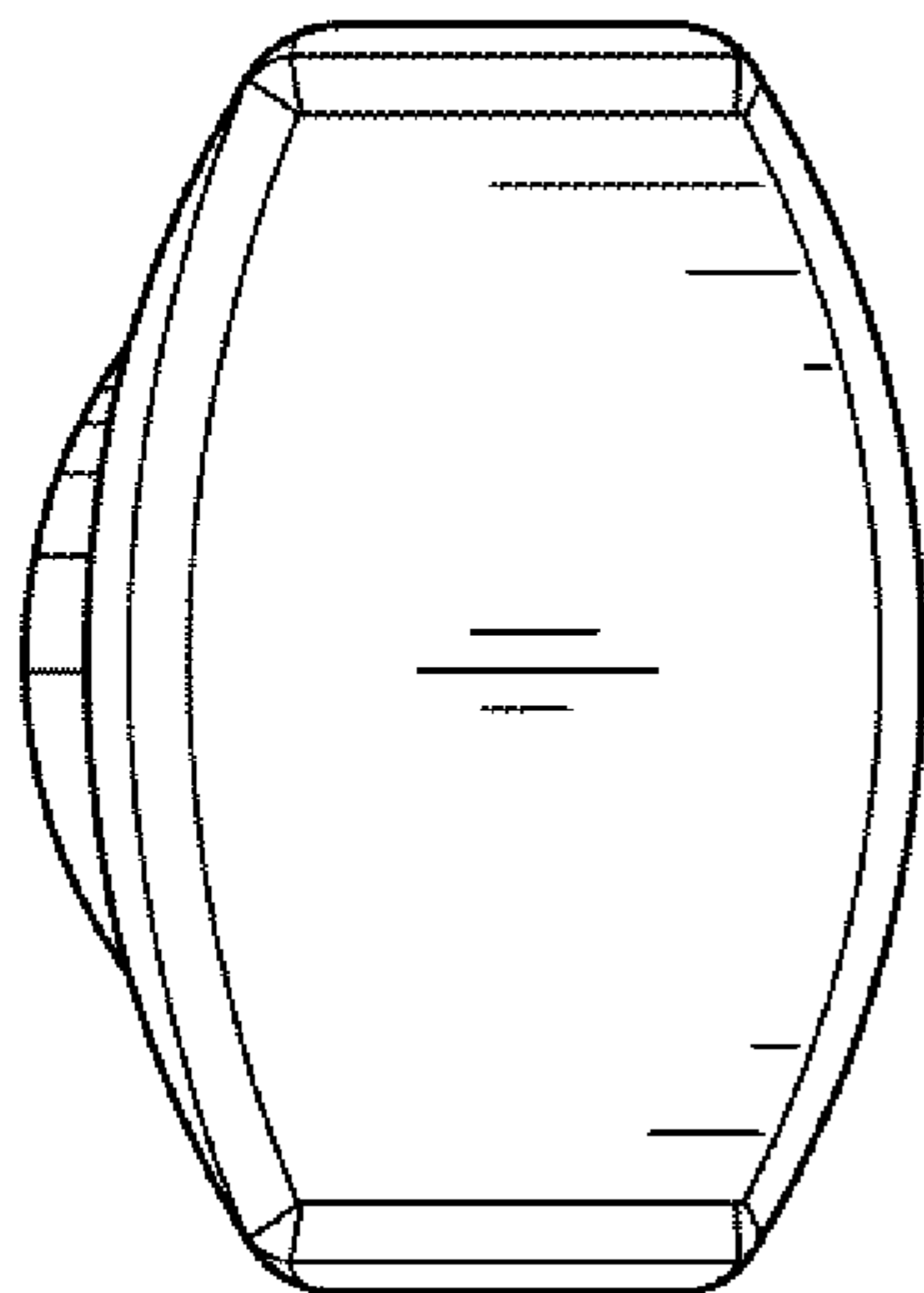

FIG. 13