



US00D646122S

(12) **United States Design Patent**
Burns

(10) **Patent No.:** **US D646,122 S**
(45) **Date of Patent:** **** Oct. 4, 2011**

(54) **CUP AND SAUCER SET**

(75) Inventor: **Thomas Elliott Burns**, Los Angeles, CA (US)

(73) Assignee: **Misaine Trade, Inc.**, Gardena, CA (US)

(**) Term: **14 Years**

(21) Appl. No.: **29/354,920**

(22) Filed: **Jan. 29, 2010**

(51) **LOC (9) Cl.** **07-01**

(52) **U.S. Cl.** **D7/505; D7/536**

(58) **Field of Classification Search** D7/505,
D7/507, 536, 545, 500, 510, 511, 317, 316,
D7/523, 412, 376, 608, 532; D9/551, 529;
215/121, 382, 388, 387; 220/674, 715, 713,
220/718, 592.16, 592.17, 709, 708

See application file for complete search history.

(56) **References Cited**

U.S. PATENT DOCUMENTS

D102,968	S	*	1/1937	Farber	D7/505
2,151,023	A	*	3/1939	Gibson	220/23.83
2,799,147	A	*	7/1957	Crawford, Jr.	220/23.83
D205,534	S	*	8/1966	Gulotta	D7/507
D244,738	S	*	6/1977	Juhlin	D7/507
D411,940	S	*	7/1999	Horvat	D7/507
D448,622	S	*	10/2001	Horvat	D7/555
D522,312	S	*	6/2006	Bodum	D7/536
D552,931	S	*	10/2007	Bodum	D7/536
D560,972	S	*	2/2008	Sung	D7/536
D582,725	S	*	12/2008	Burns	D7/536

* cited by examiner

Primary Examiner — Cynthia Underwood

(74) *Attorney, Agent, or Firm* — Knobbe, Martens, Olson & Bear LLP

(57) **CLAIM**

The ornamental design for a cup and saucer set, as shown and described herein.

DESCRIPTION

FIG. 1 is a perspective view of a first embodiment of a saucer.
FIG. 2 is a top plan view of the saucer shown in FIG. 1.

FIG. 3 is a cross-sectional view of the saucer shown in FIG. 1 taken along the line 3-3 shown in FIG. 2.

FIG. 4 is a bottom plan view of the saucer shown in FIG. 1.

FIG. 5 is a perspective view of the cup and saucer set

FIG. 6 is a top plan view of the saucer shown in FIG. 5.

FIG. 7 is a cross-sectional view of the saucer shown in FIG. 5 taken along the line 7-7 shown in FIG. 6.

FIG. 8 is a bottom plan view of the saucer shown in FIG. 5.

FIG. 9 is a perspective view of a first embodiment of a cup.

FIG. 10 is a front side view of the cup shown in FIG. 9, the back side being a mirror image of the front side view.

FIG. 11 is a left side view of the cup shown in FIG. 9.

FIG. 12 is a right side view of the cup shown in FIG. 9.

FIG. 13 is a bottom plan view of the cup shown in FIG. 9.

FIG. 14 is a top plan view of the cup shown in FIG. 9.

FIG. 15 is a cross-sectional view of the cup shown in FIG. 9 taken along the line 15-15 shown in FIG. 14.

FIG. 16 is a perspective view of the first embodiment of a cup shown in FIGS. 9-15 in relation to the saucer shown in FIGS. 1-4.

FIG. 17 is a perspective view of the first embodiment of a cup shown in FIGS. 9-15 in relation to the saucer shown in FIGS. 5-8.

FIG. 18 is a perspective view of a second embodiment of a cup.

FIG. 19 is a front side view of the cup shown in FIG. 18, the back side being a mirror image of the front side view.

FIG. 20 is a left side view of the cup shown in FIG. 18.

FIG. 21 is a right side view of the cup shown in FIG. 18.

FIG. 22 is a bottom plan view of the cup shown in FIG. 18.

FIG. 23 is a top plan view of the cup shown in FIG. 18.

FIG. 24 is a cross-sectional view of the cup shown in FIG. 18 taken along the line 24-24 shown in FIG. 23.

FIG. 25 is a perspective view of the second embodiment of a cup shown in FIGS. 18-24 in relation to the saucer shown in FIGS. 1-4.

FIG. 26 is a perspective view of the second embodiment of a cup shown in FIGS. 18-24 in relation to the saucer shown in FIGS. 5-8.

FIG. 27 is a perspective view of a third embodiment of a cup.

FIG. 28 is a front side view of the cup shown in FIG. 27, the back side being a mirror image of the front side view.

FIG. 29 is a left side view of the cup shown in FIG. 27.

FIG. 30 is a right side view of the cup shown in FIG. 27.

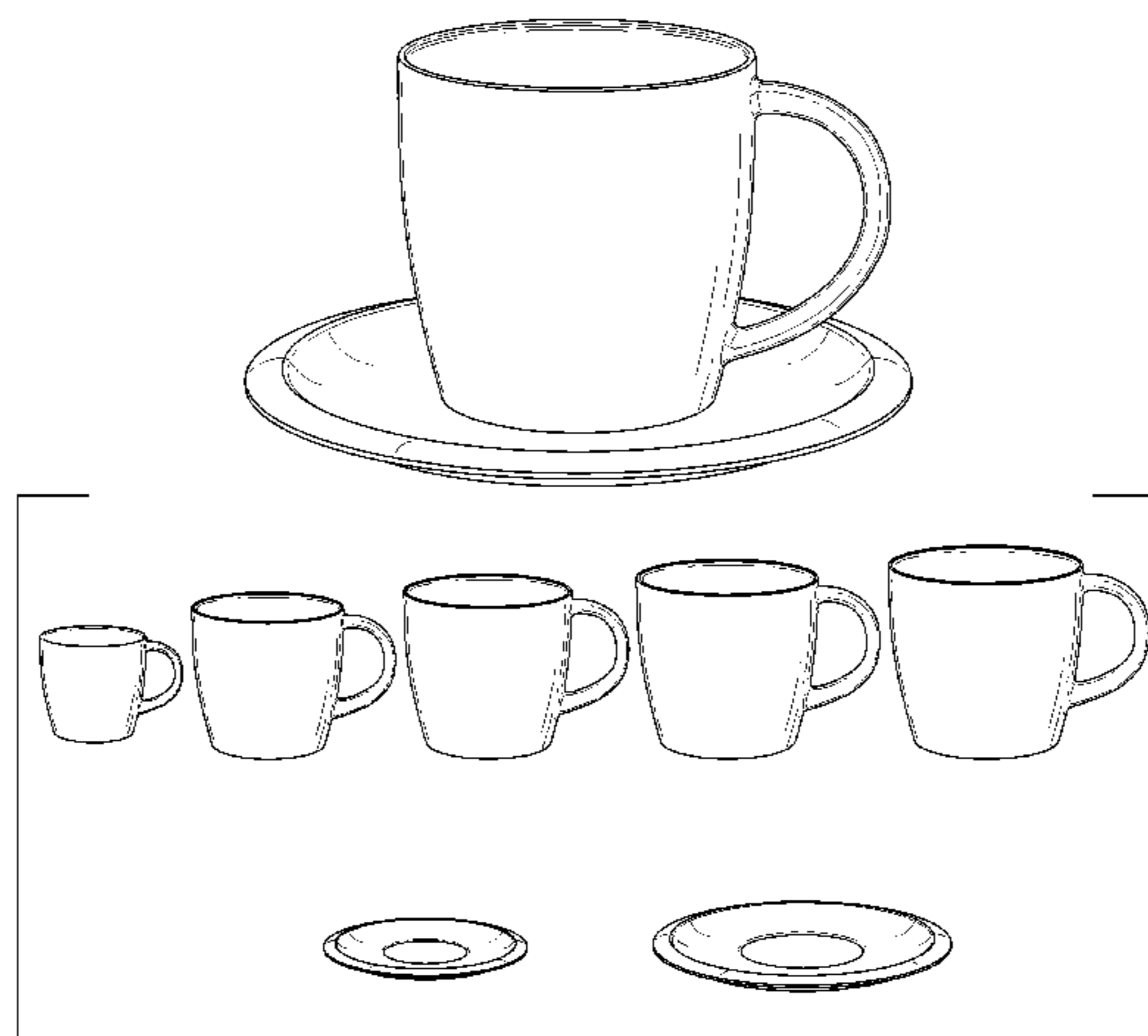

FIG. 31 is a bottom plan view of the cup shown in FIG. 27.
FIG. 32 is a top plan view of the cup shown in FIG. 27.
FIG. 33 is a cross-sectional view of the cup shown in FIG. 27 taken along the line 33-33 shown in FIG. 32.
FIG. 34 is a perspective view of the third embodiment of a cup shown in FIGS. 27-33 in relation to the saucer shown in FIGS. 1-4.
FIG. 35 is a perspective view of the third embodiment of a cup shown in FIGS. 27-33 in relation to the saucer shown in FIGS. 5-8.
FIG. 36 is a perspective view of a fourth embodiment of a cup.
FIG. 37 is a front side view of the cup shown in FIG. 36, the back side being a mirror image of the front side view.
FIG. 38 is a left side view of the cup shown in FIG. 36.
FIG. 39 is a right side view of the cup shown in FIG. 36.
FIG. 40 is a bottom plan view of the cup shown in FIG. 36.
FIG. 41 is a top plan view of the cup shown in FIG. 36.
FIG. 42 is a cross-sectional view of the cup shown in FIG. 36 taken along the line 42-42 shown in FIG. 41.
FIG. 43 is a perspective view of the fourth embodiment of a cup shown in FIGS. 36-42 in relation to the saucer shown in FIGS. 1-4.

FIG. 44 is a perspective view of the fourth embodiment of a cup shown in FIGS. 36-42 in relation to the saucer shown in FIGS. 5-8.
FIG. 45 is a perspective view of a fifth embodiment of a cup.
FIG. 46 is a front side view of the cup shown in FIG. 45, the back side being substantially a mirror image of the front side view.
FIG. 47 is a left side view of the cup shown in FIG. 45.
FIG. 48 is a right side view of the cup shown in FIG. 45.
FIG. 49 is a bottom plan view of the cup shown in FIG. 45.
FIG. 50 is a top plan view of the cup shown in FIG. 45.
FIG. 51 is a cross-sectional view of the cup shown in FIG. 45 taken along the line 51-51 shown in FIG. 50.
FIG. 52 is a perspective view of the fifth embodiment of a cup shown in FIGS. 45-51 in relation to the saucer shown in FIGS. 1-4.
FIG. 53 is a perspective view of the fifth embodiment of a cup shown in FIGS. 45-51 in relation to the saucer shown in FIGS. 5-8.
FIG. 54 is a perspective view of the five embodiments of cups shown in FIGS. 9-53 in relation to one another; and,
FIG. 55 is a perspective view of the cup and saucer set.

1 Claim, 47 Drawing Sheets

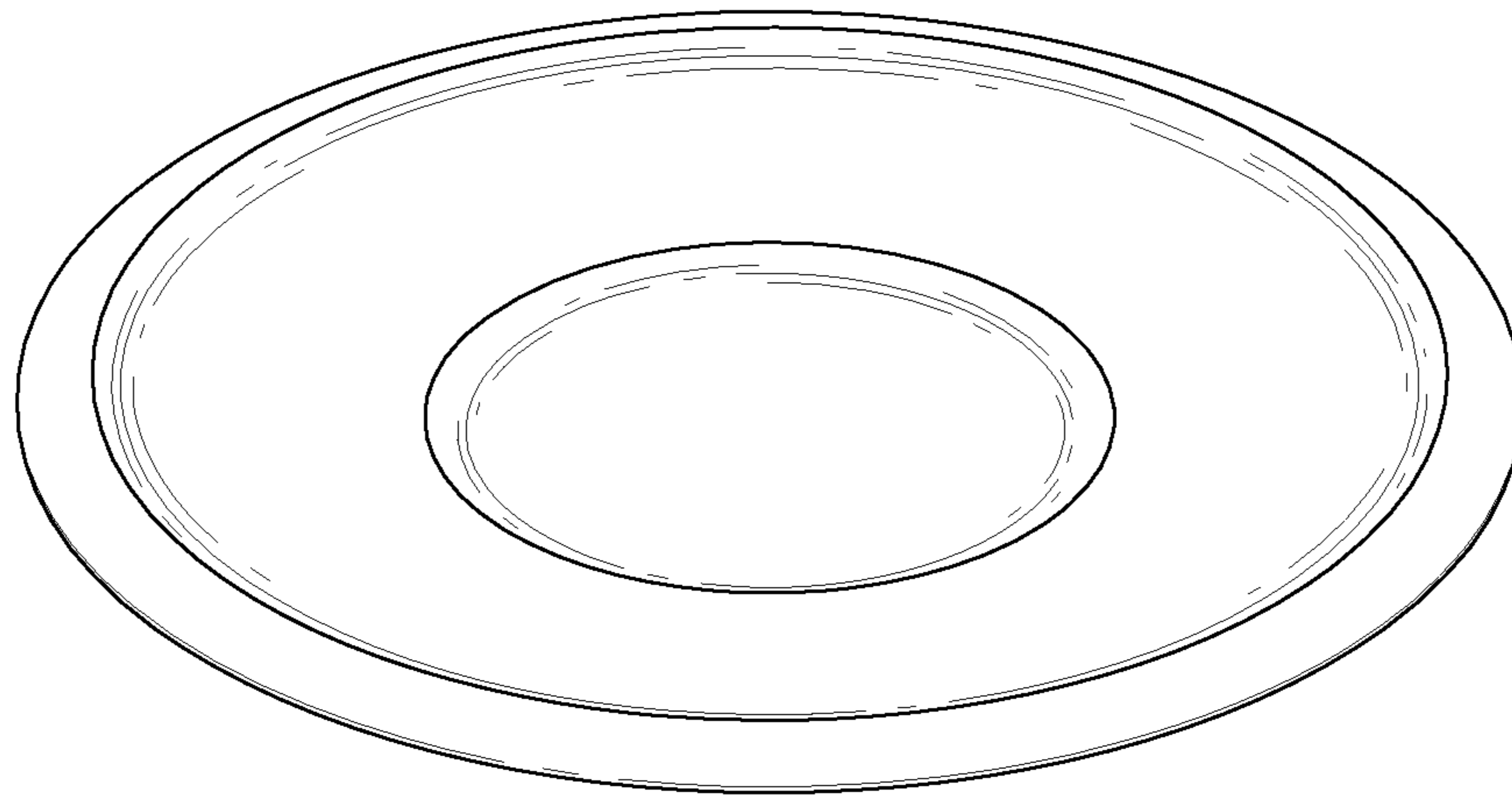

FIG. 1

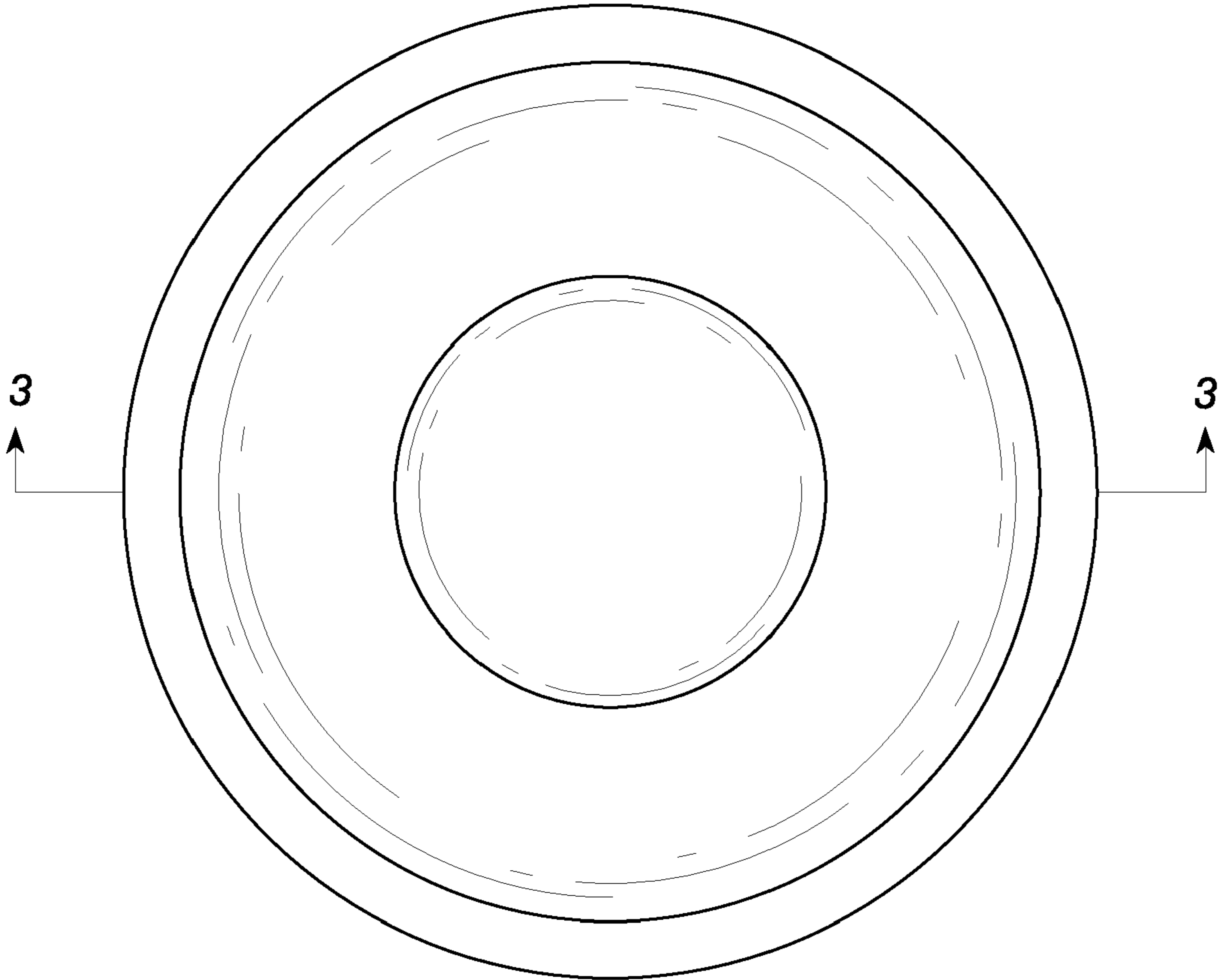

FIG. 2

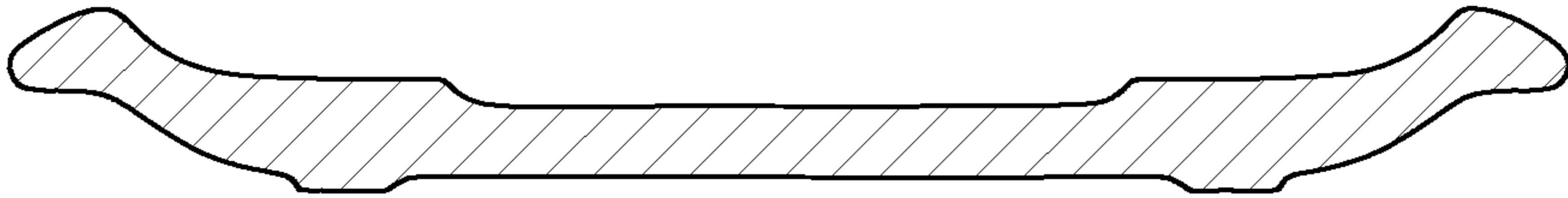

FIG. 3

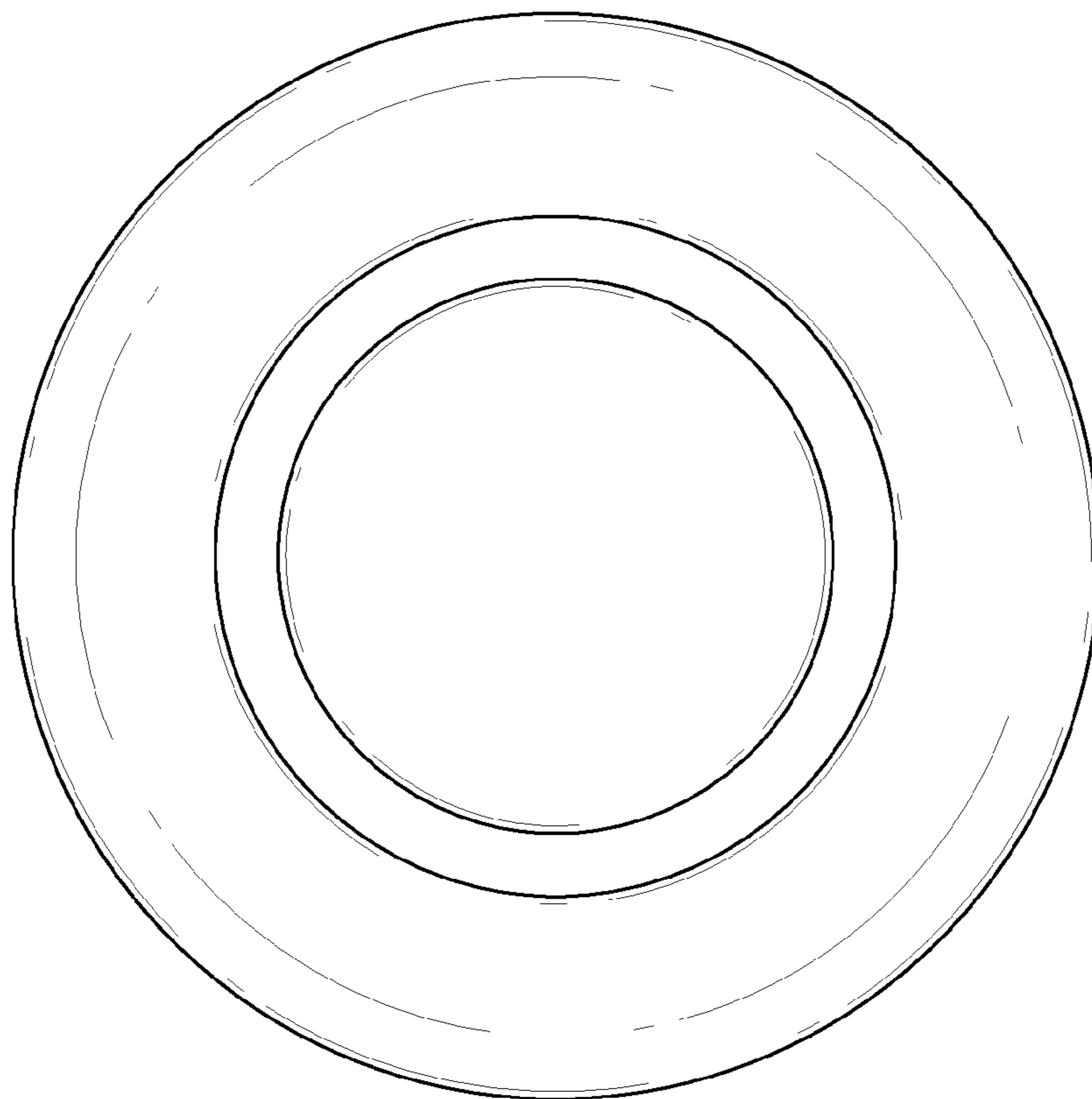

FIG. 4

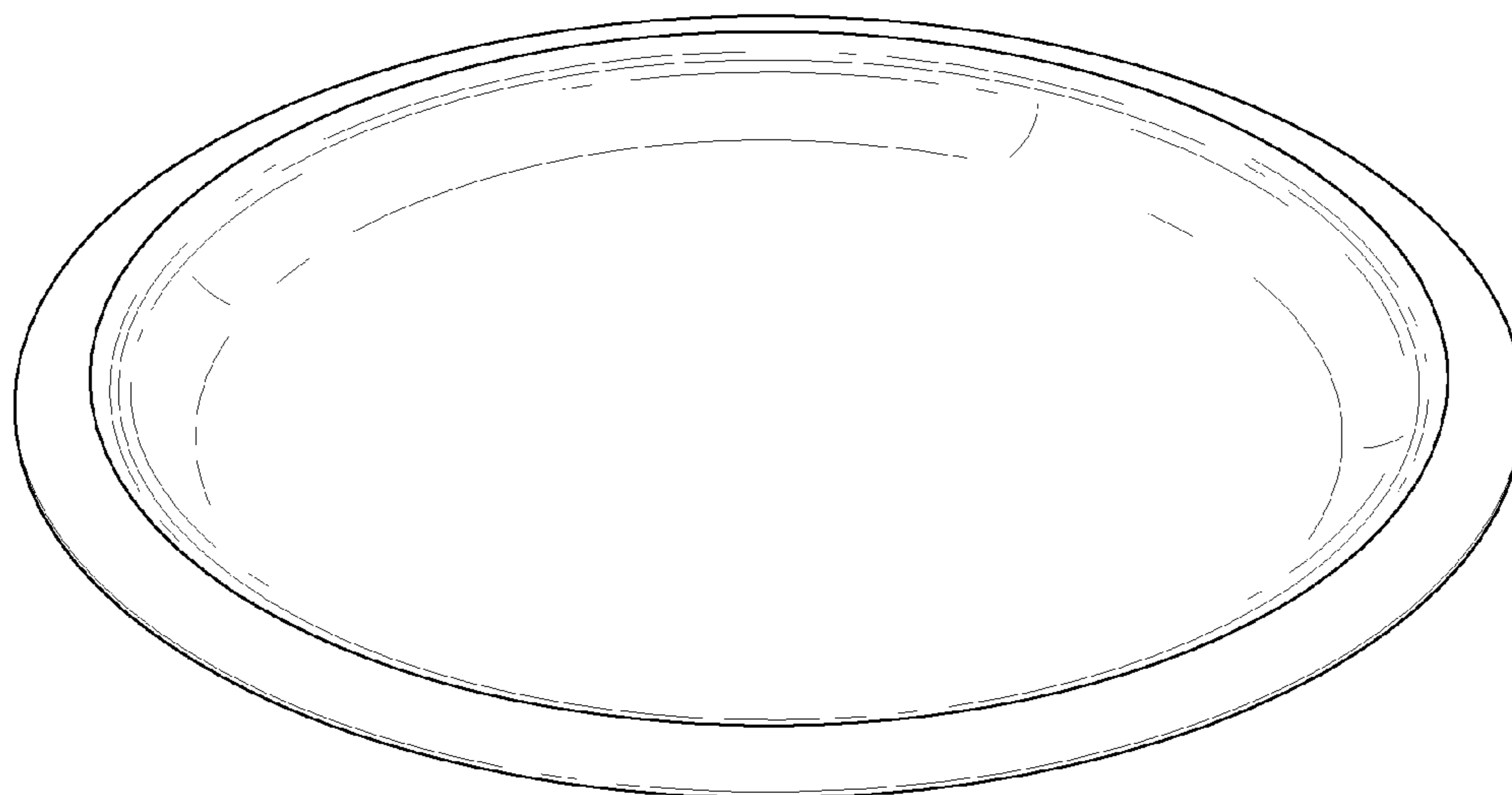

FIG. 5

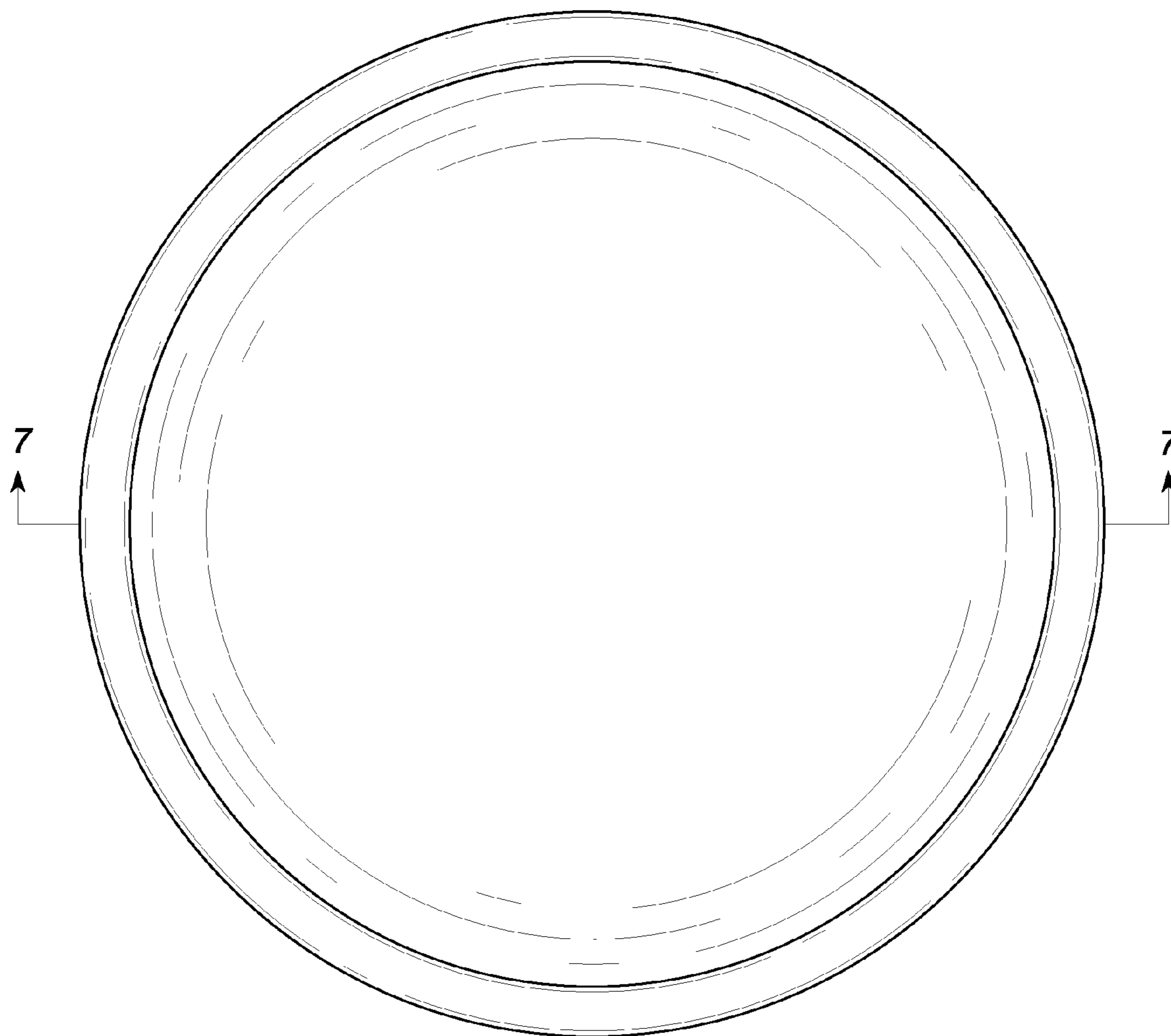

FIG. 6

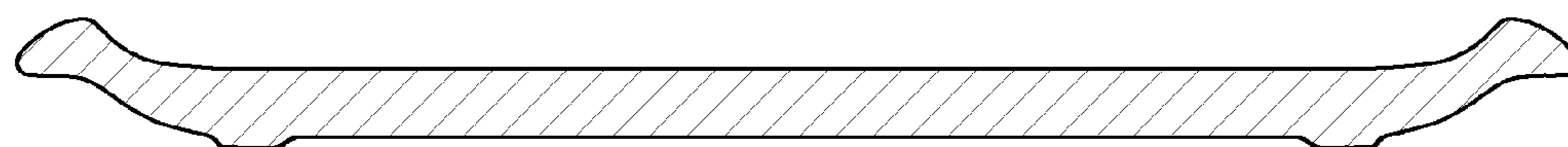

FIG. 7

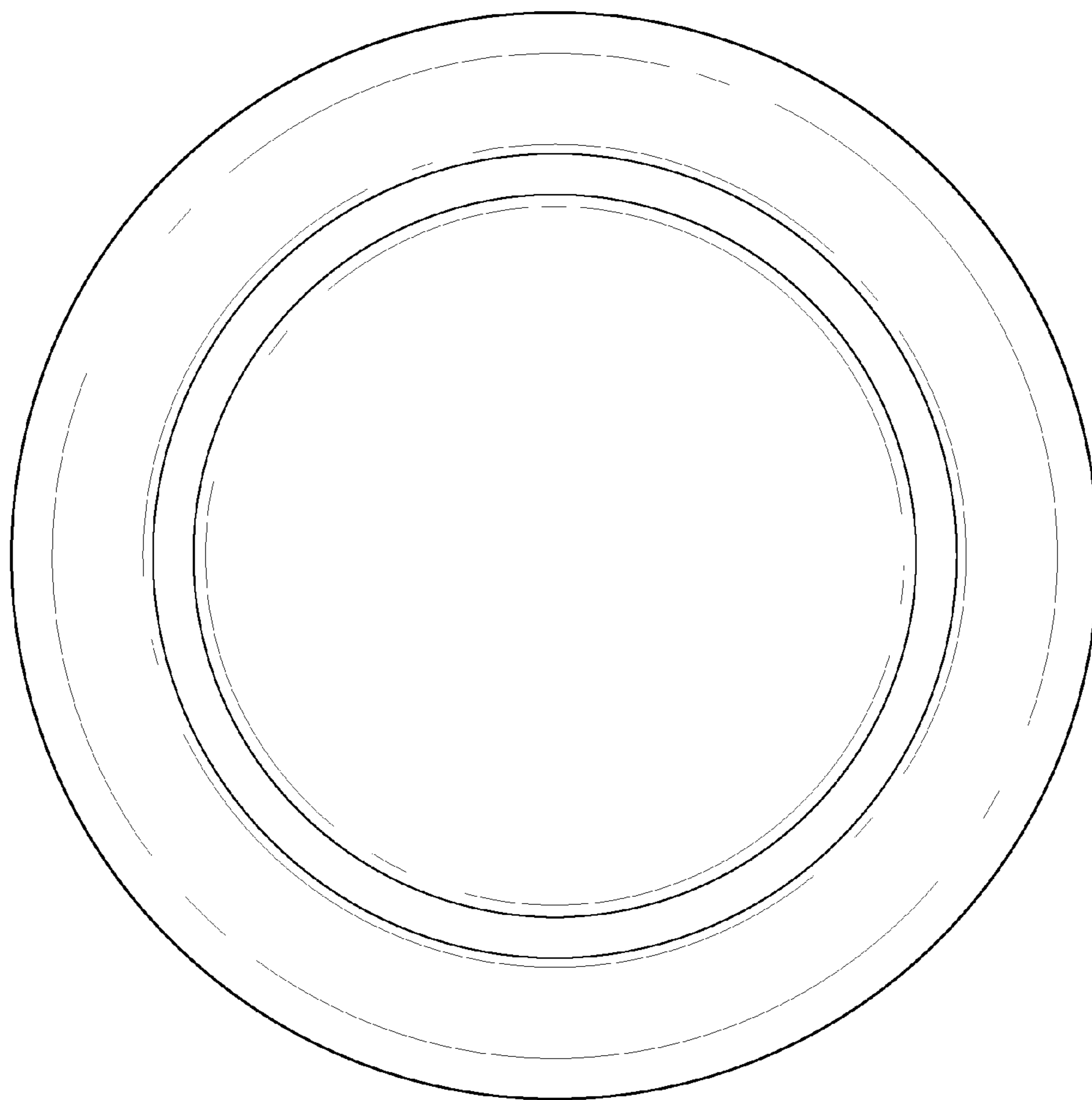

FIG. 8



FIG. 9

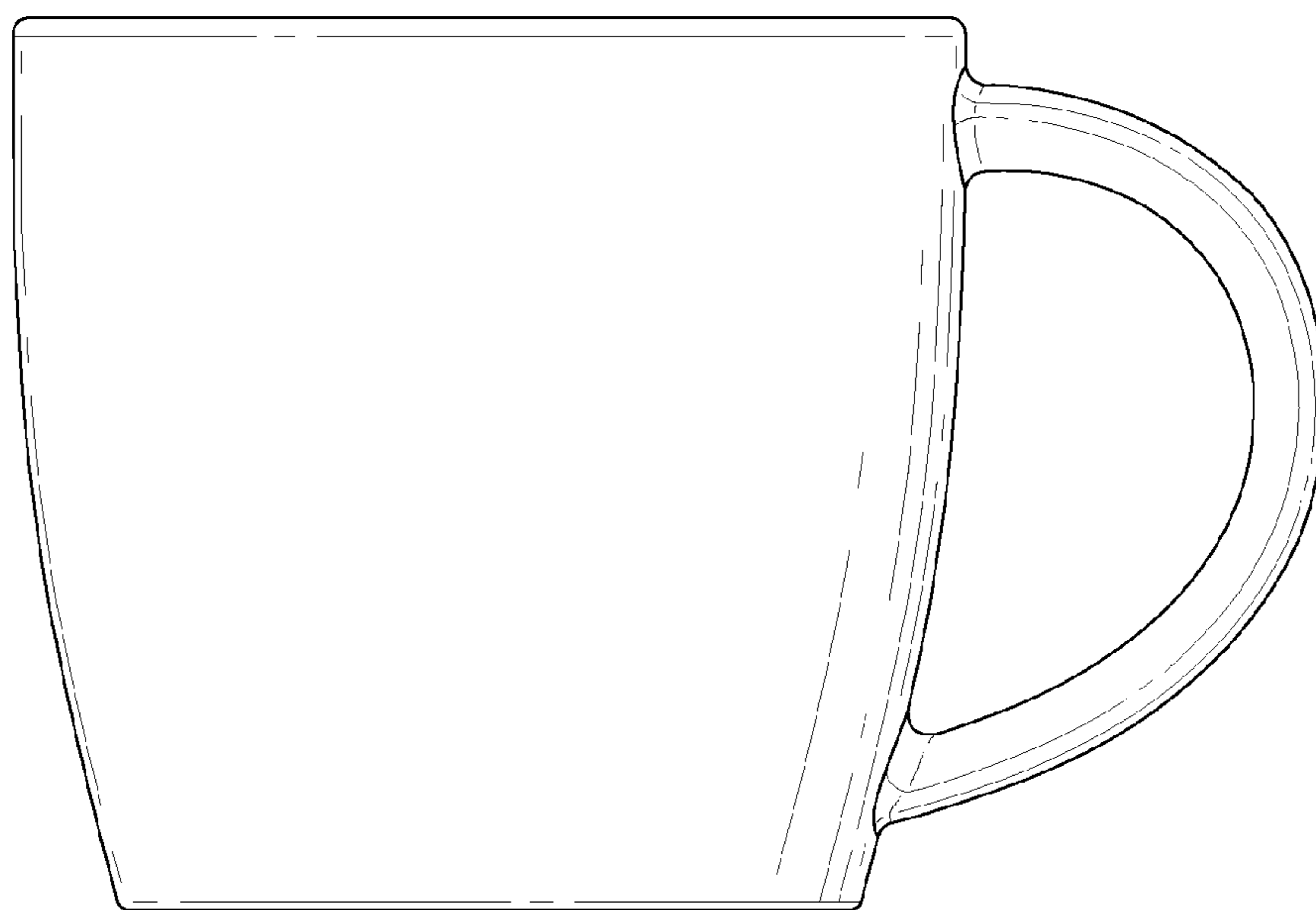

FIG. 10

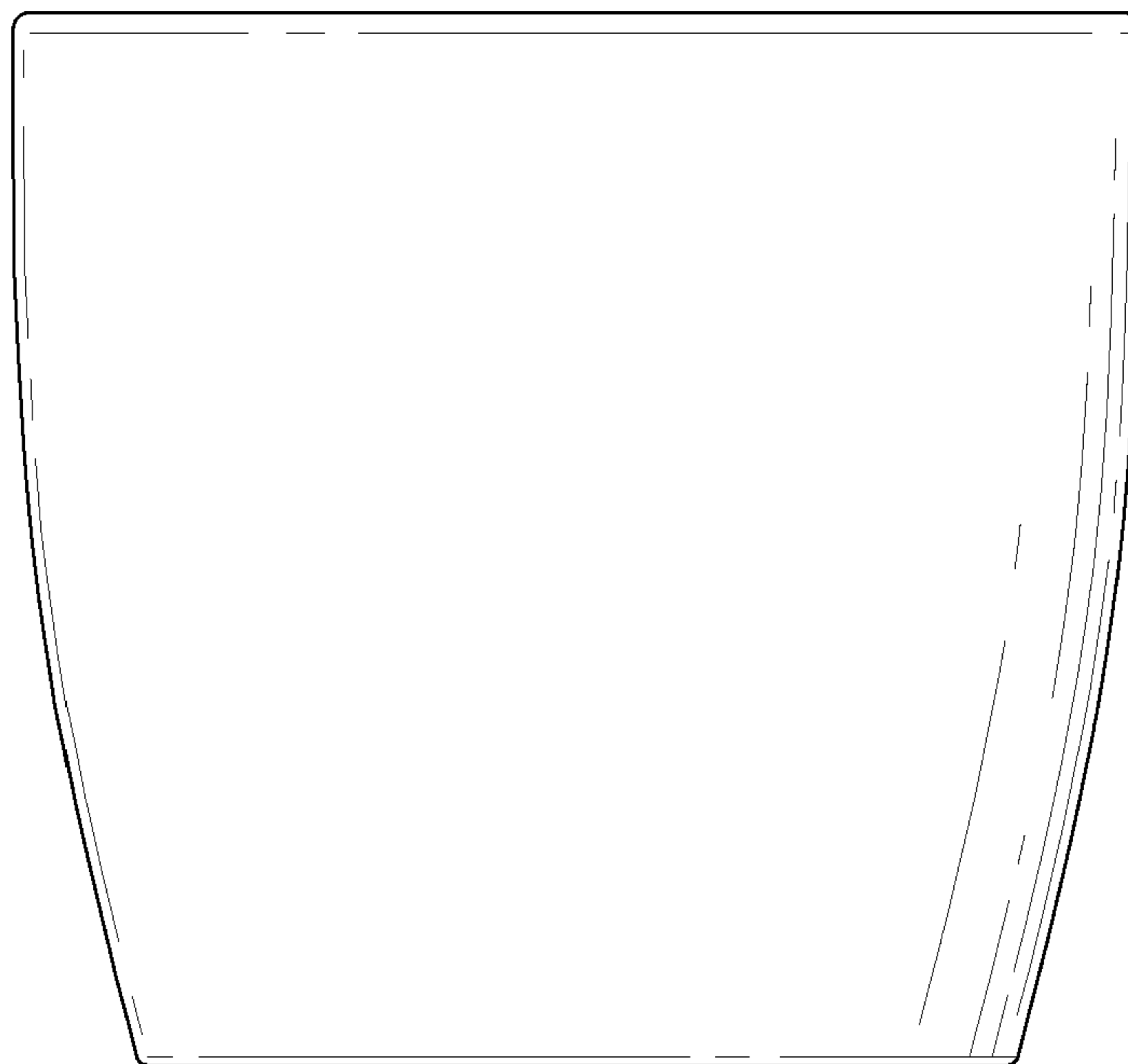

FIG. 11

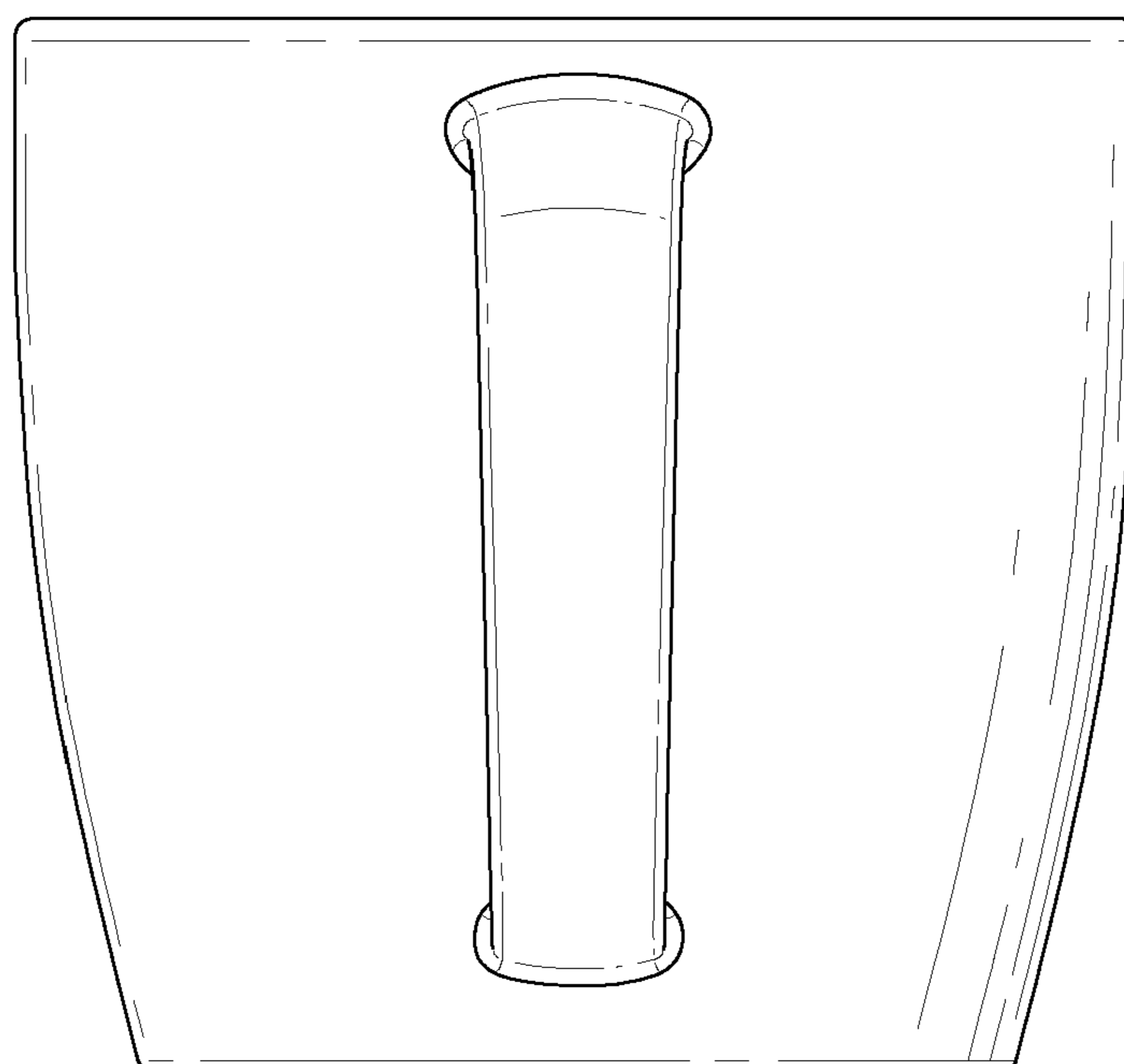

FIG. 12

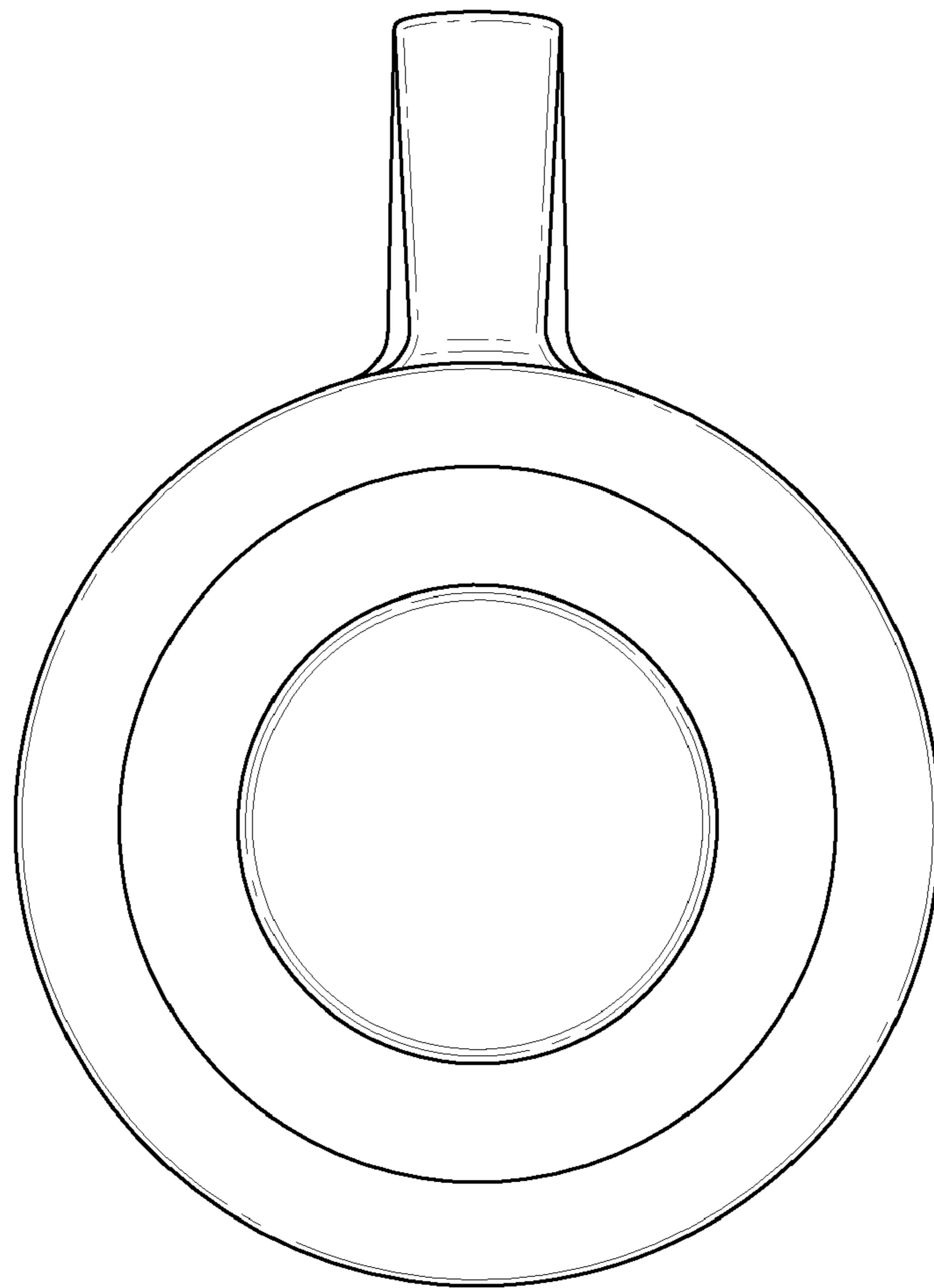

FIG. 13

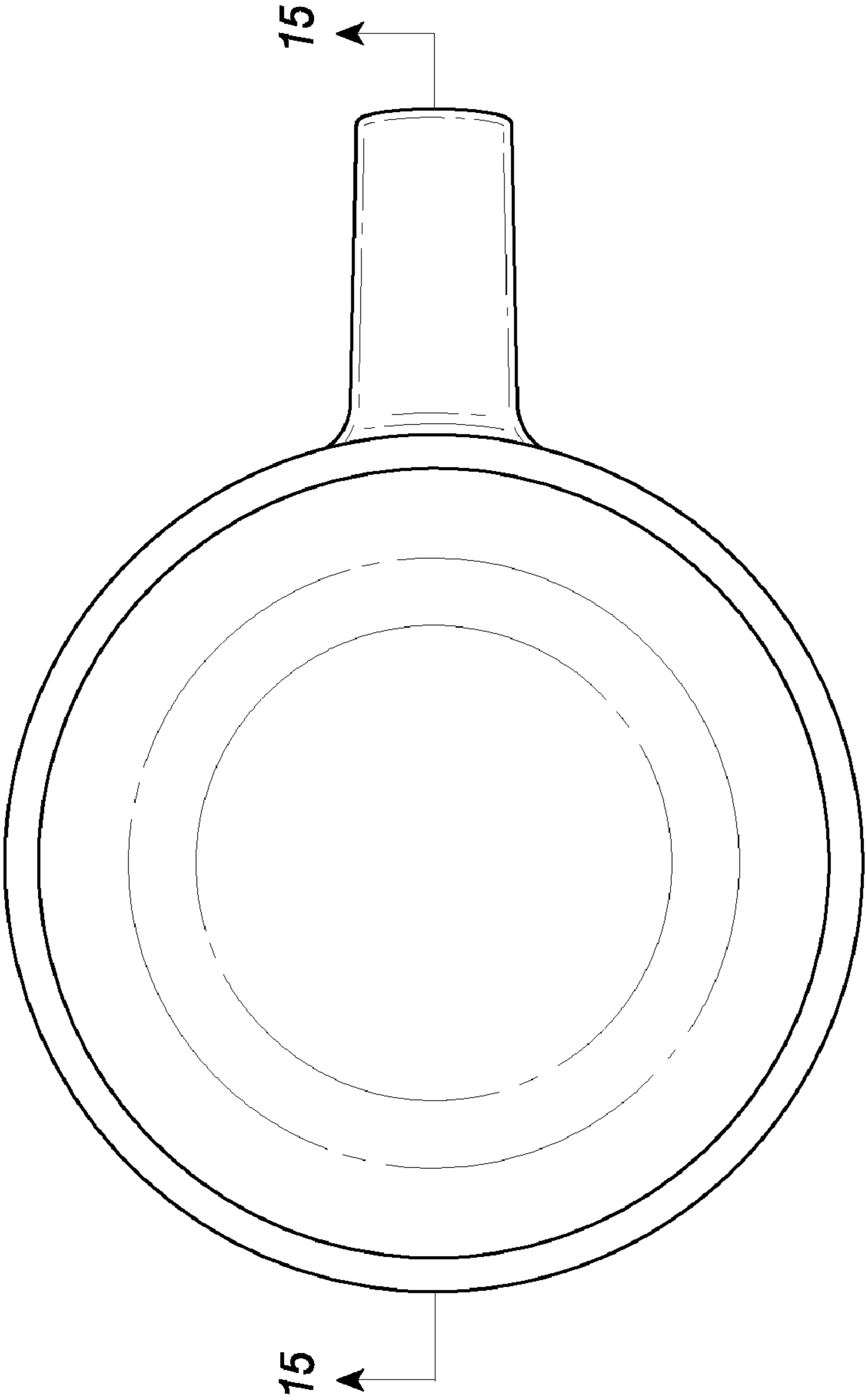

FIG. 14

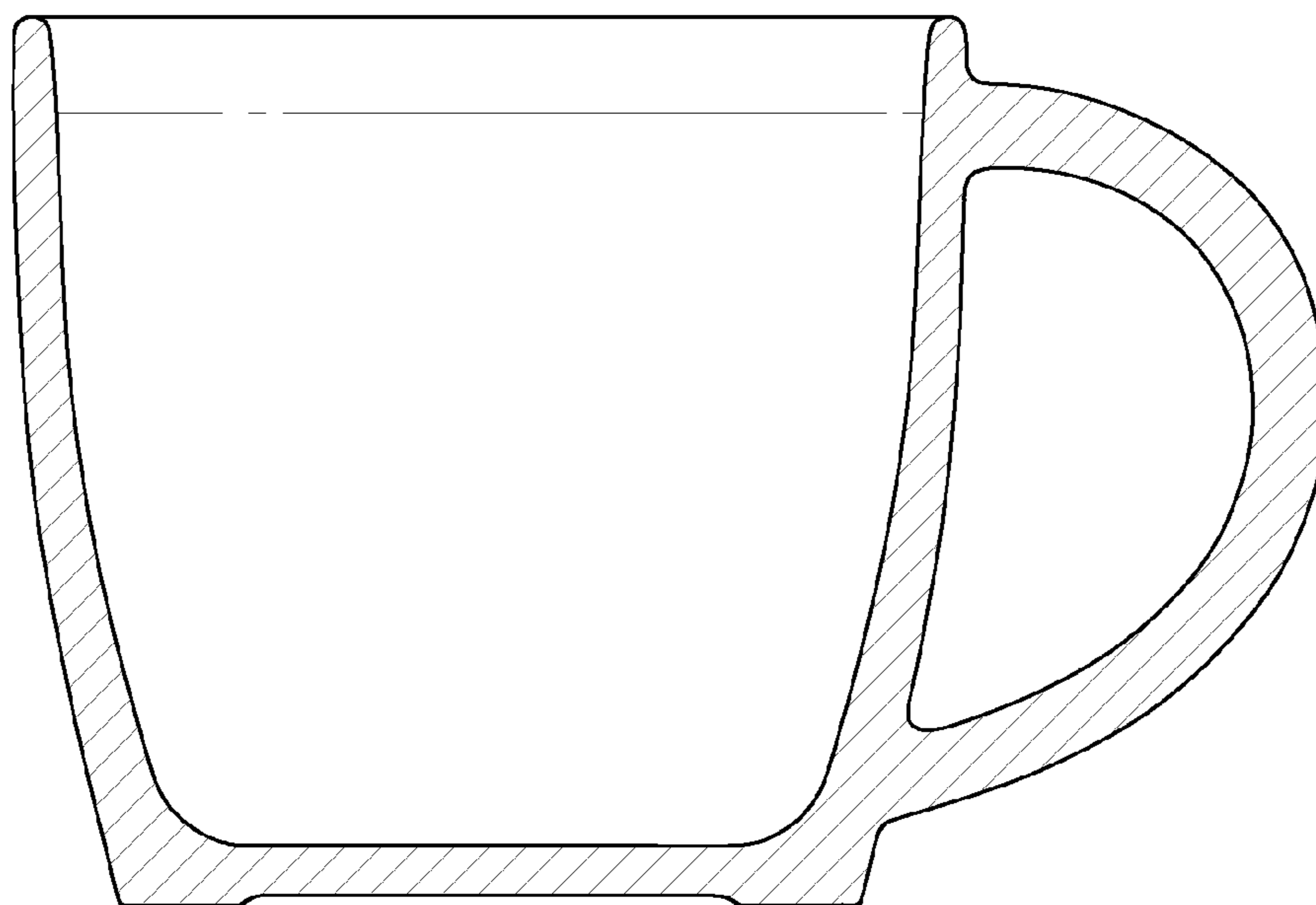

FIG. 15



FIG. 16

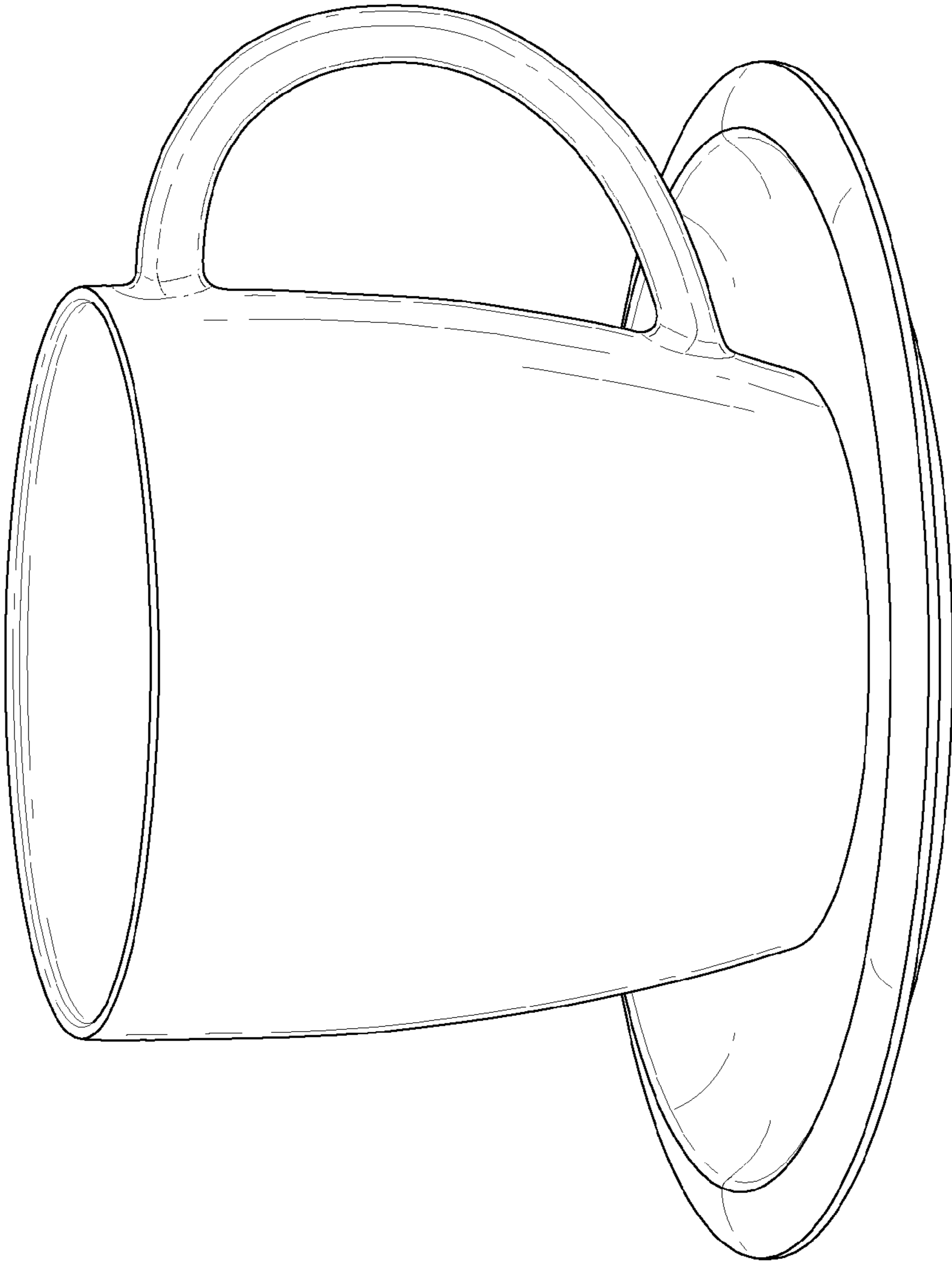

FIG. 17



FIG. 18

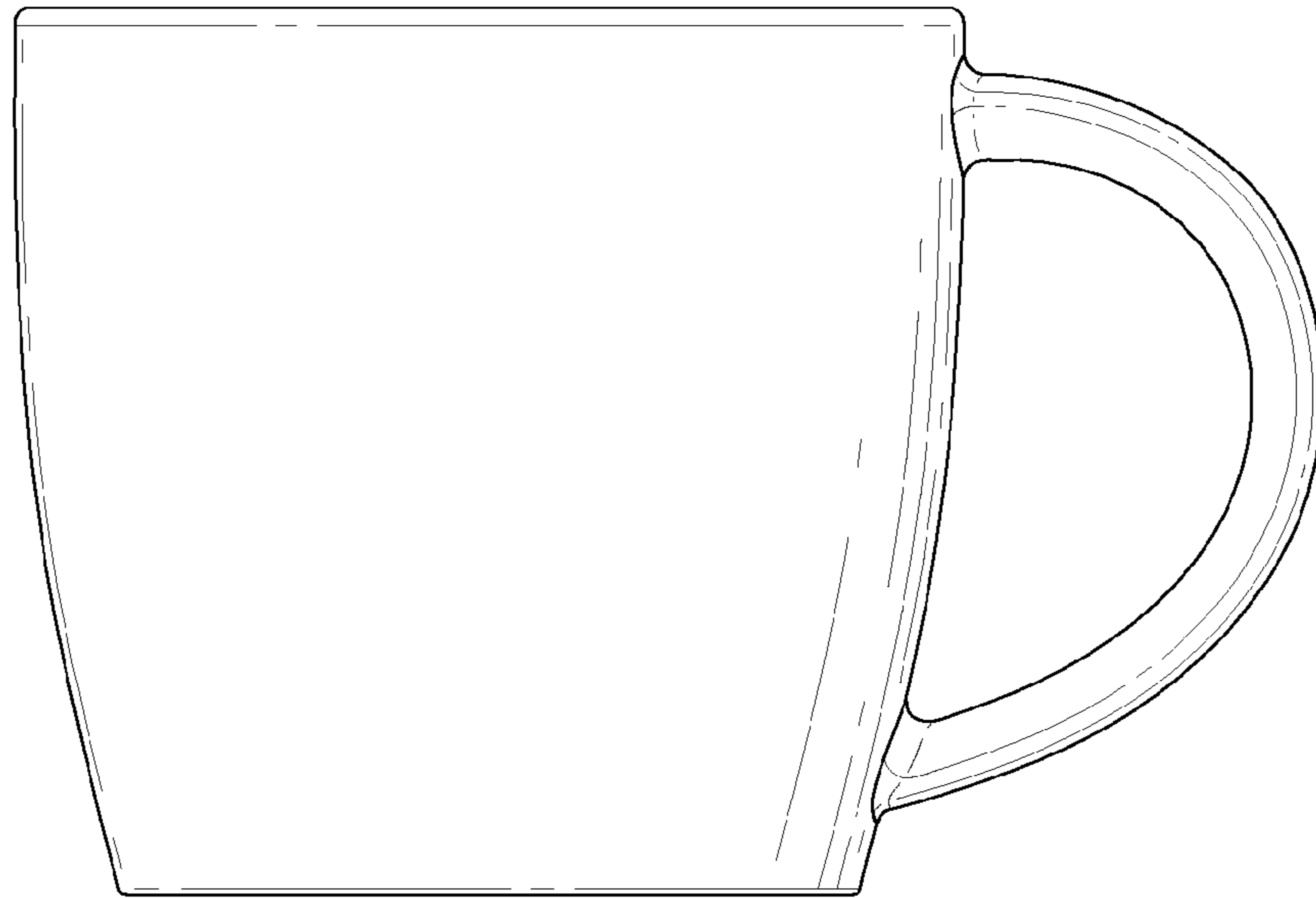

FIG. 19

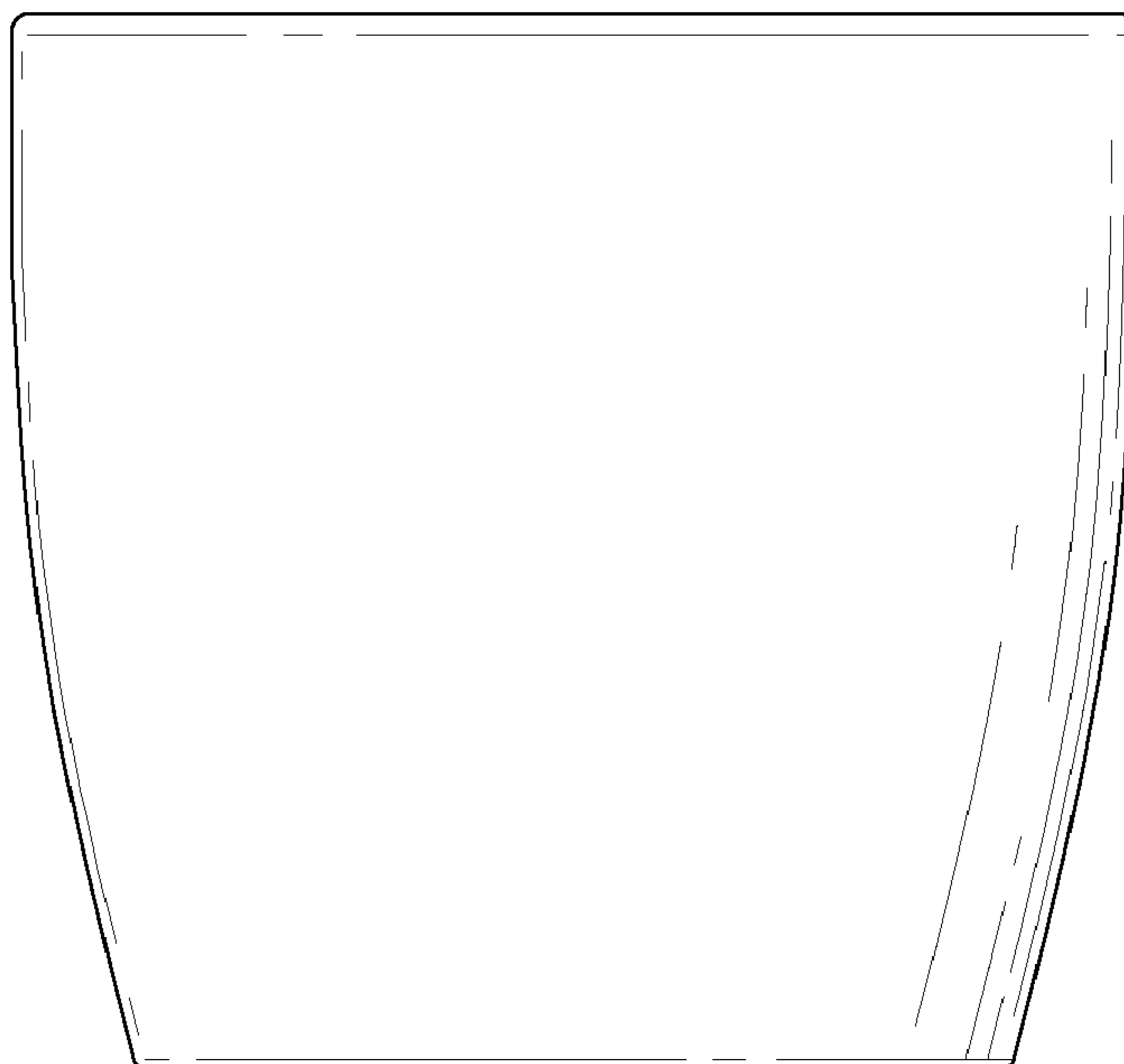

FIG. 20

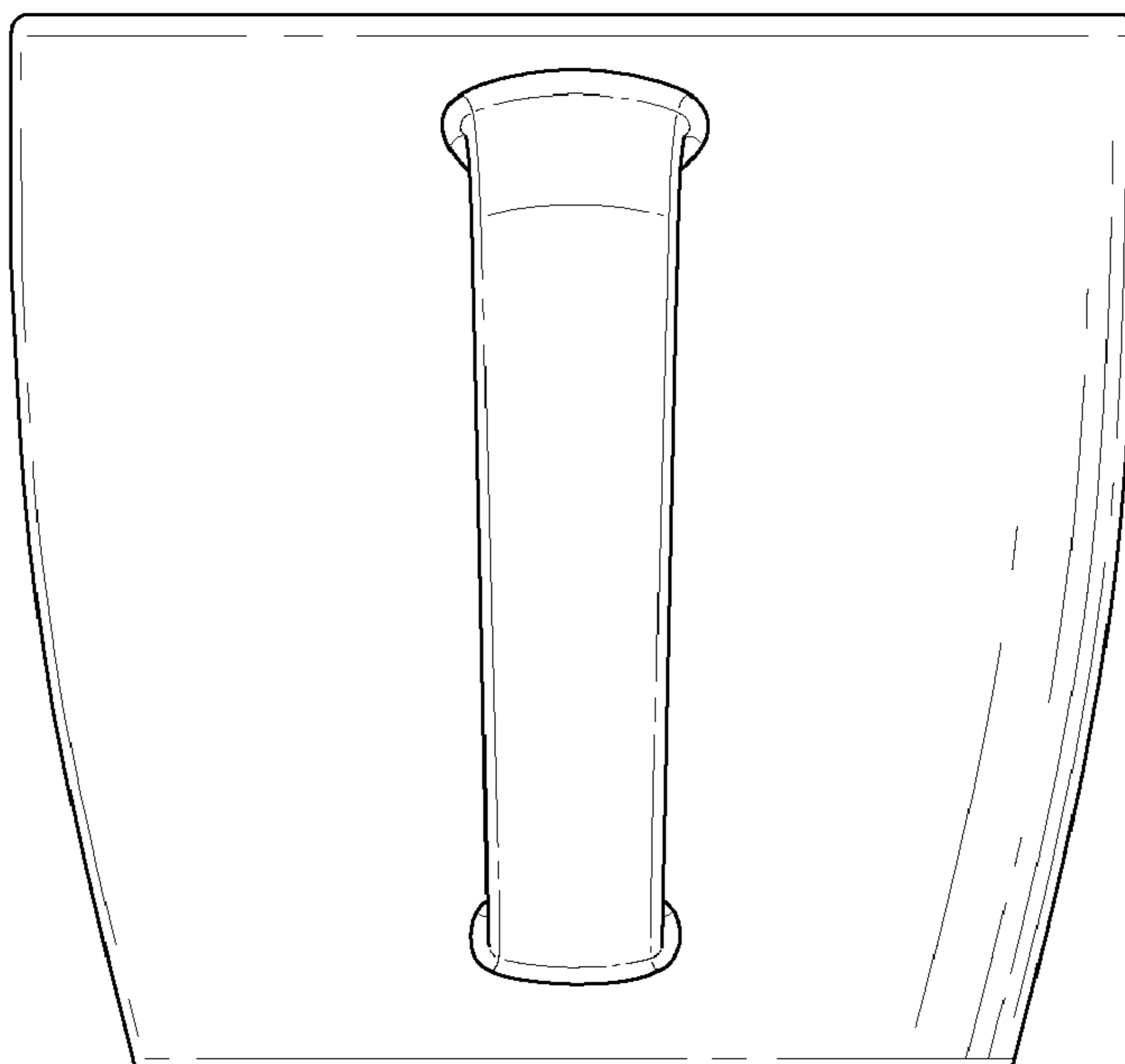

FIG. 21

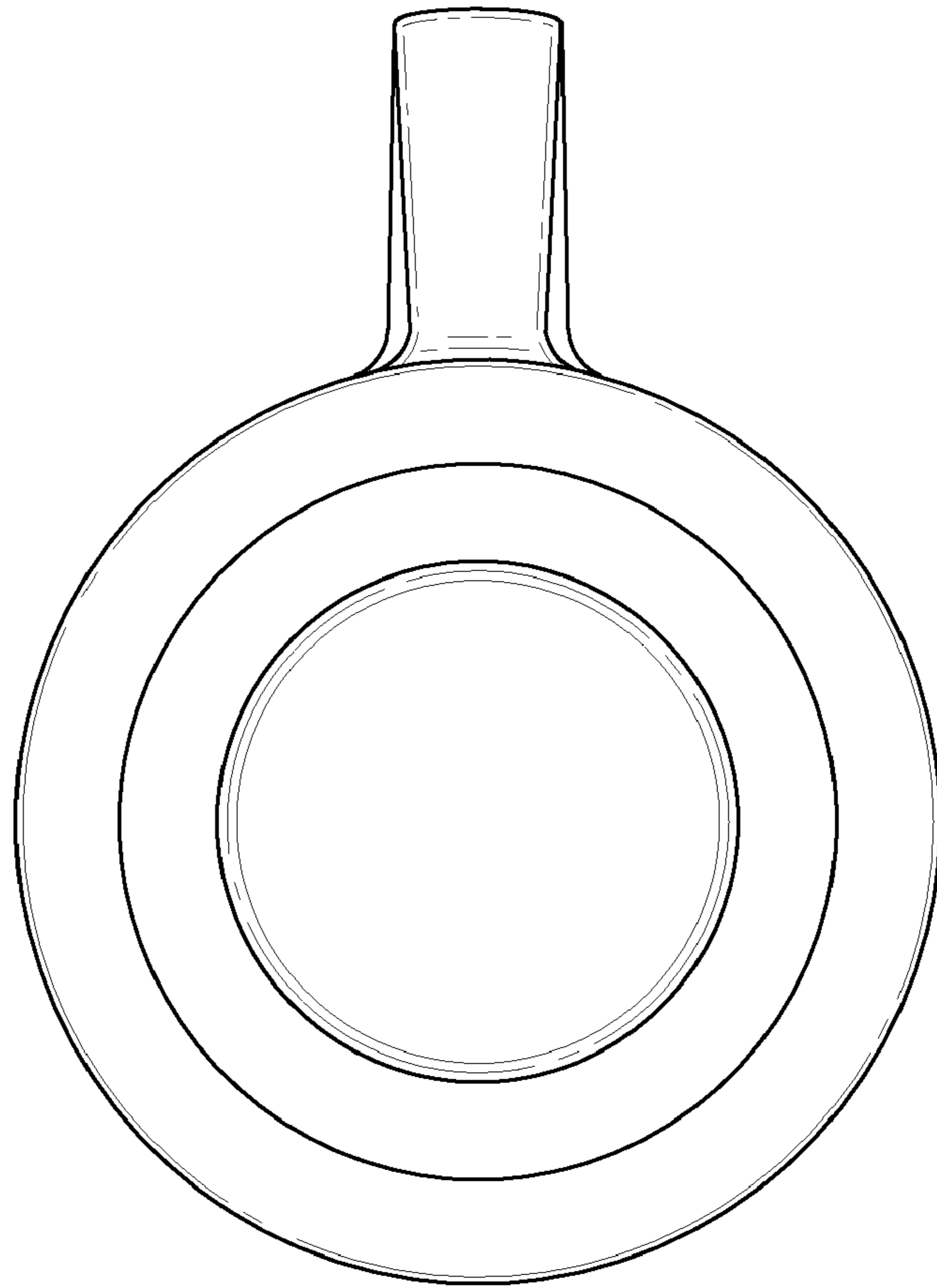

FIG. 22

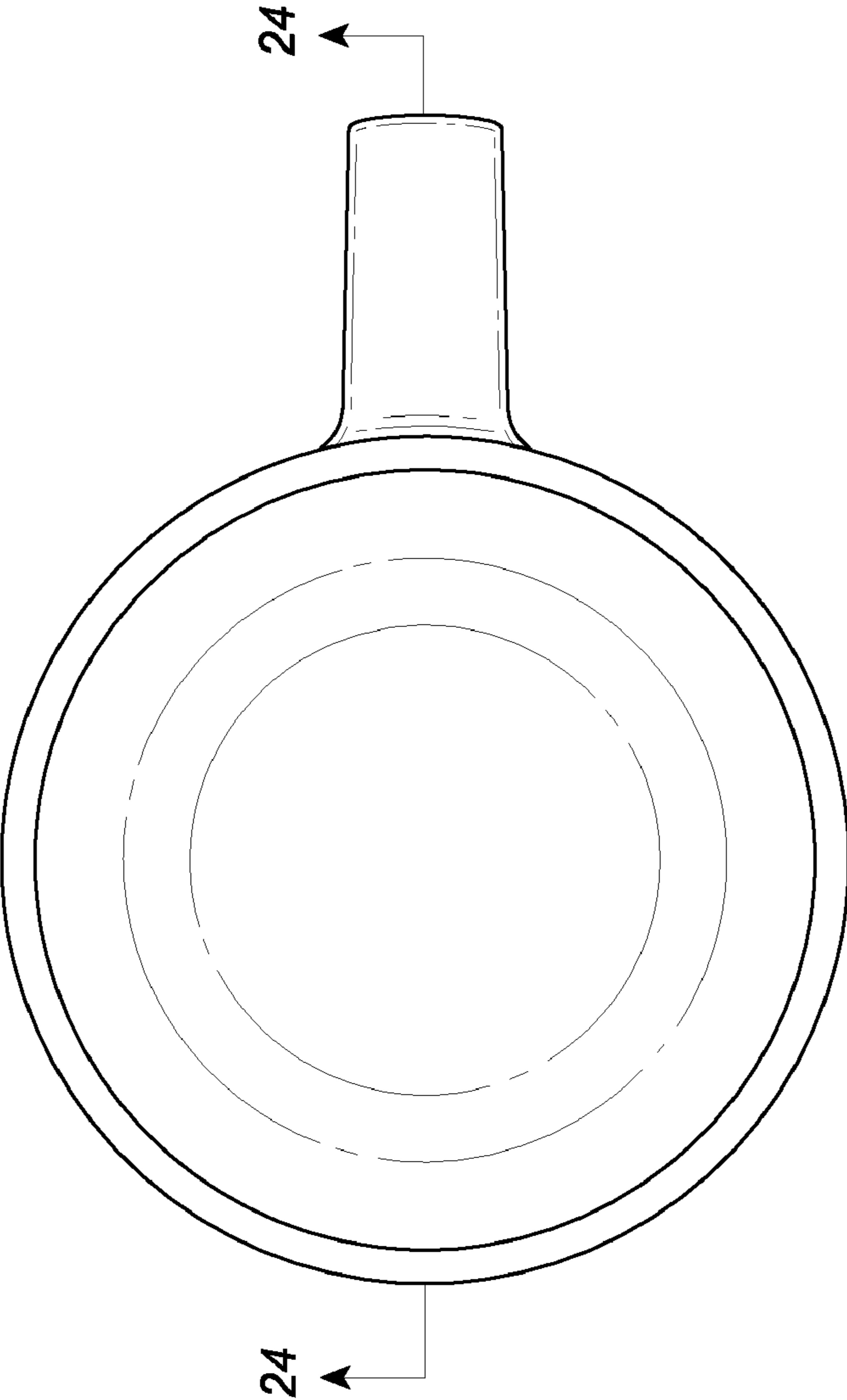

FIG. 23

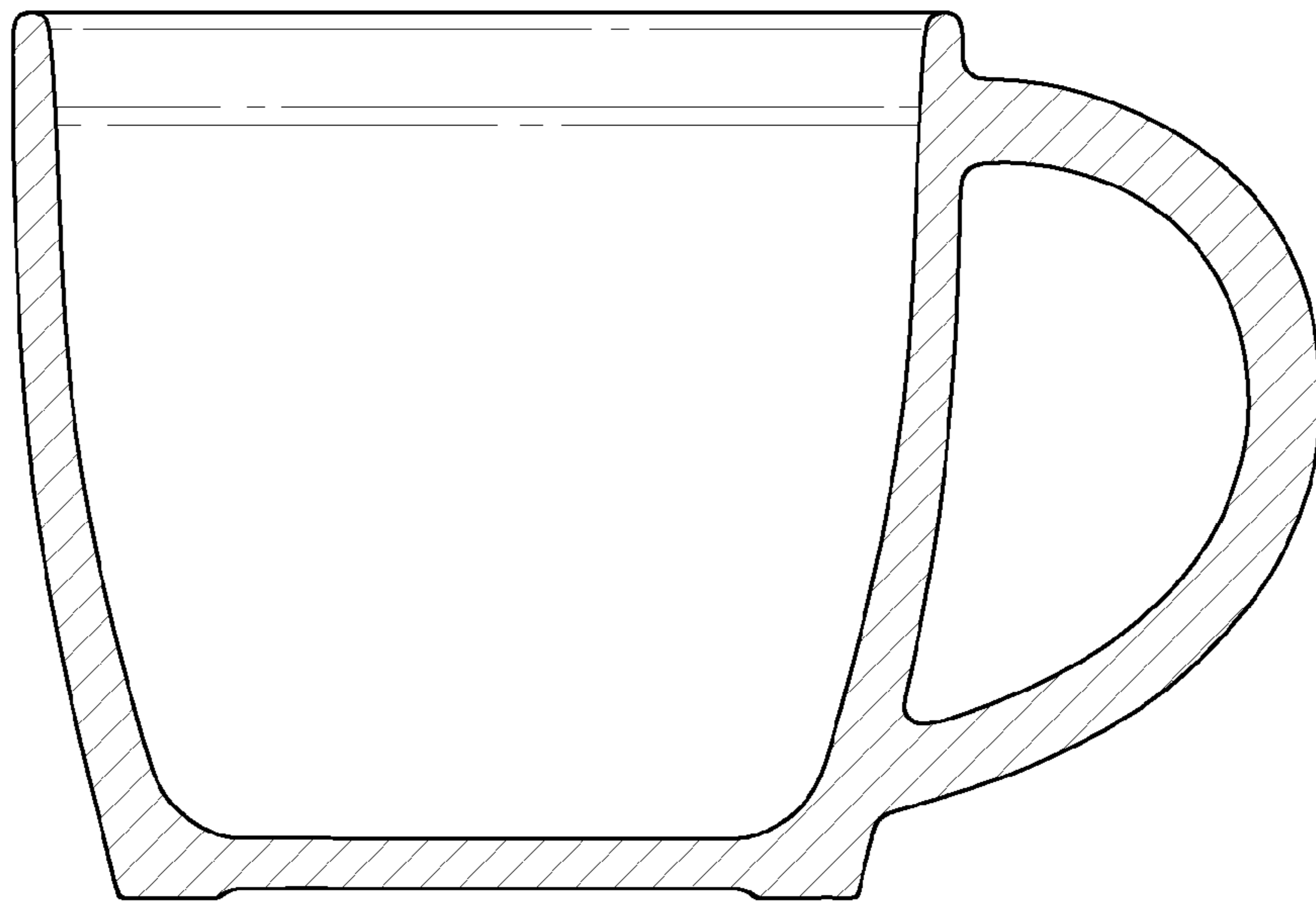

FIG.24



FIG. 25

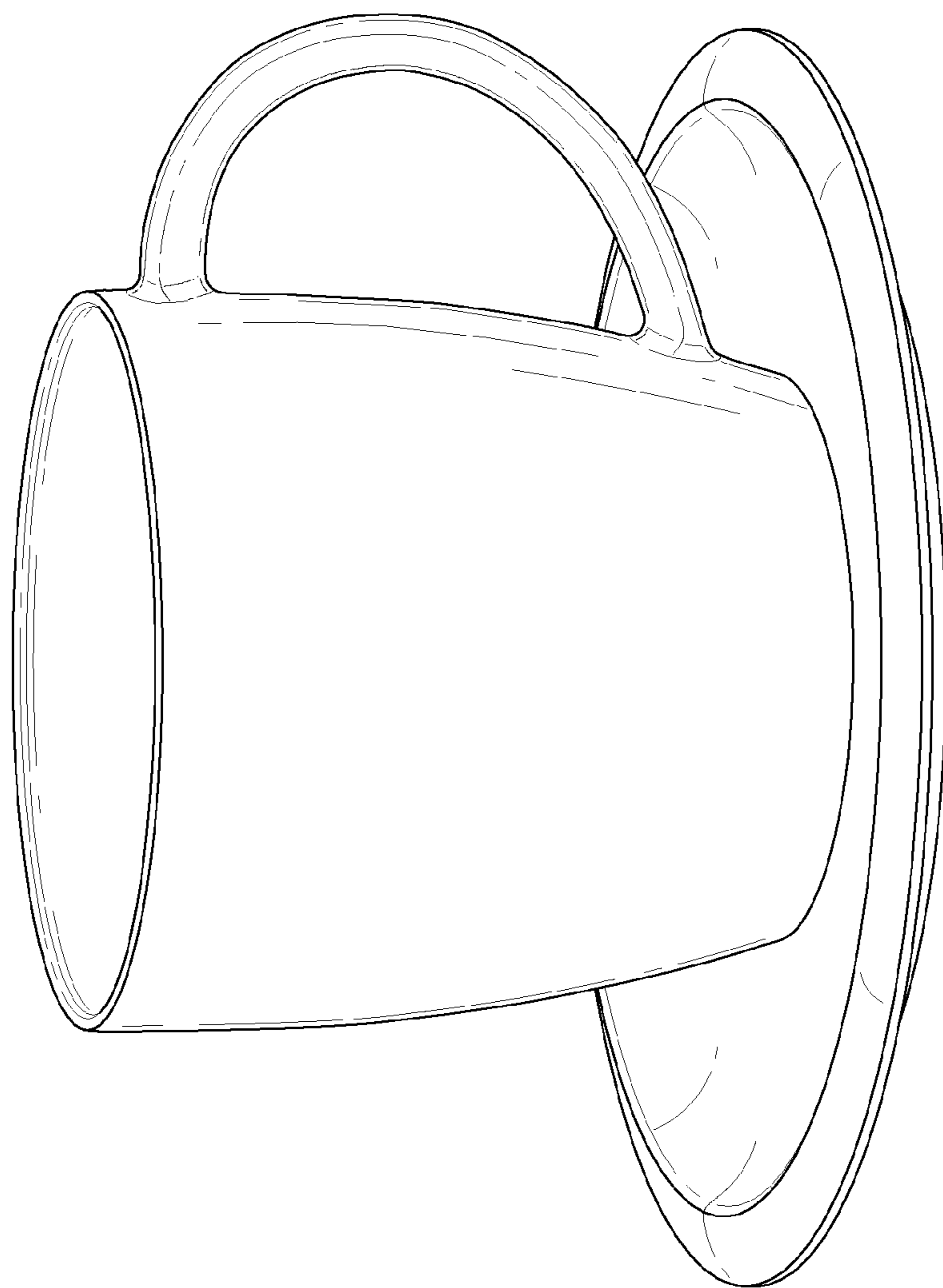

FIG. 26



FIG. 27

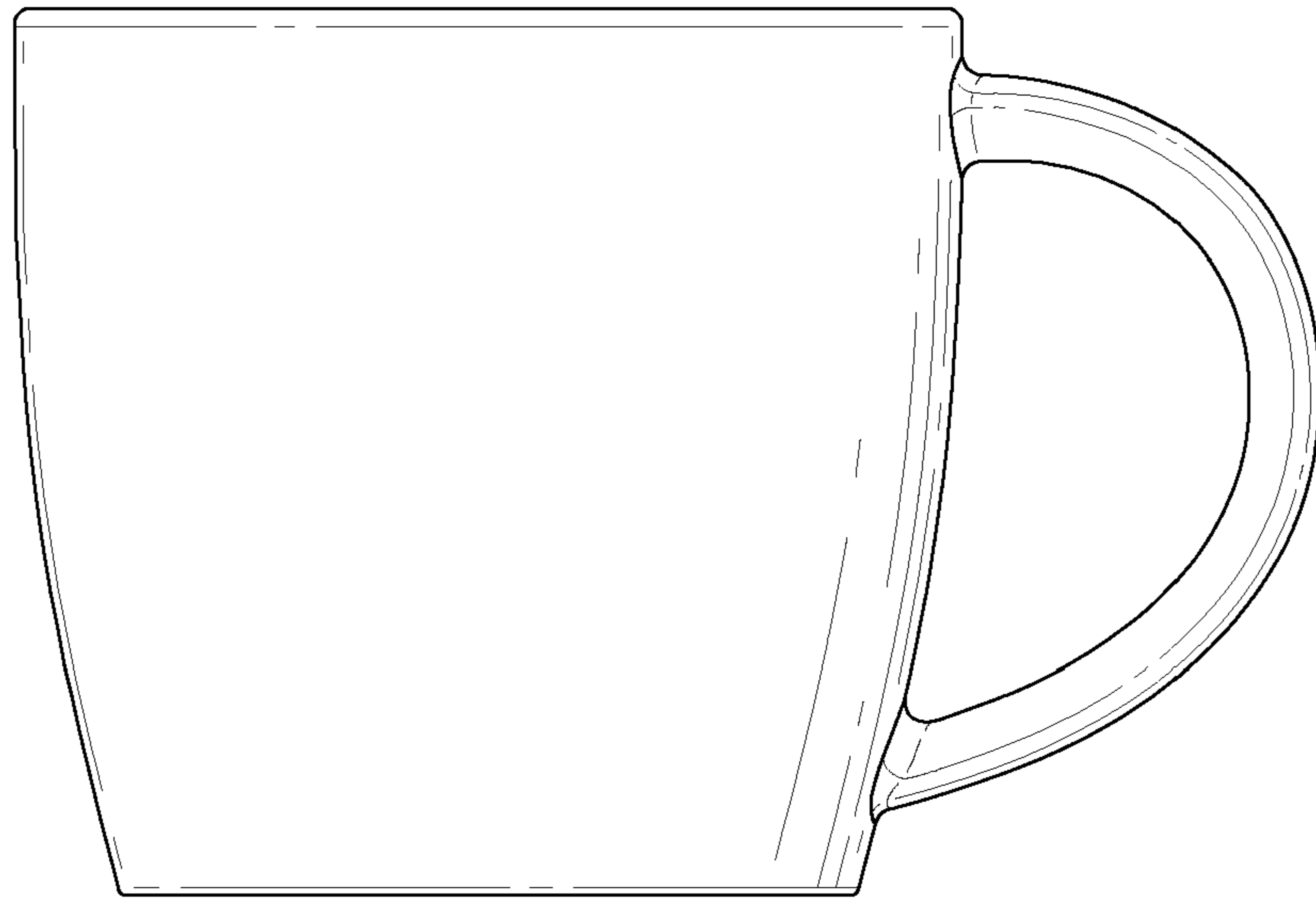

FIG.28

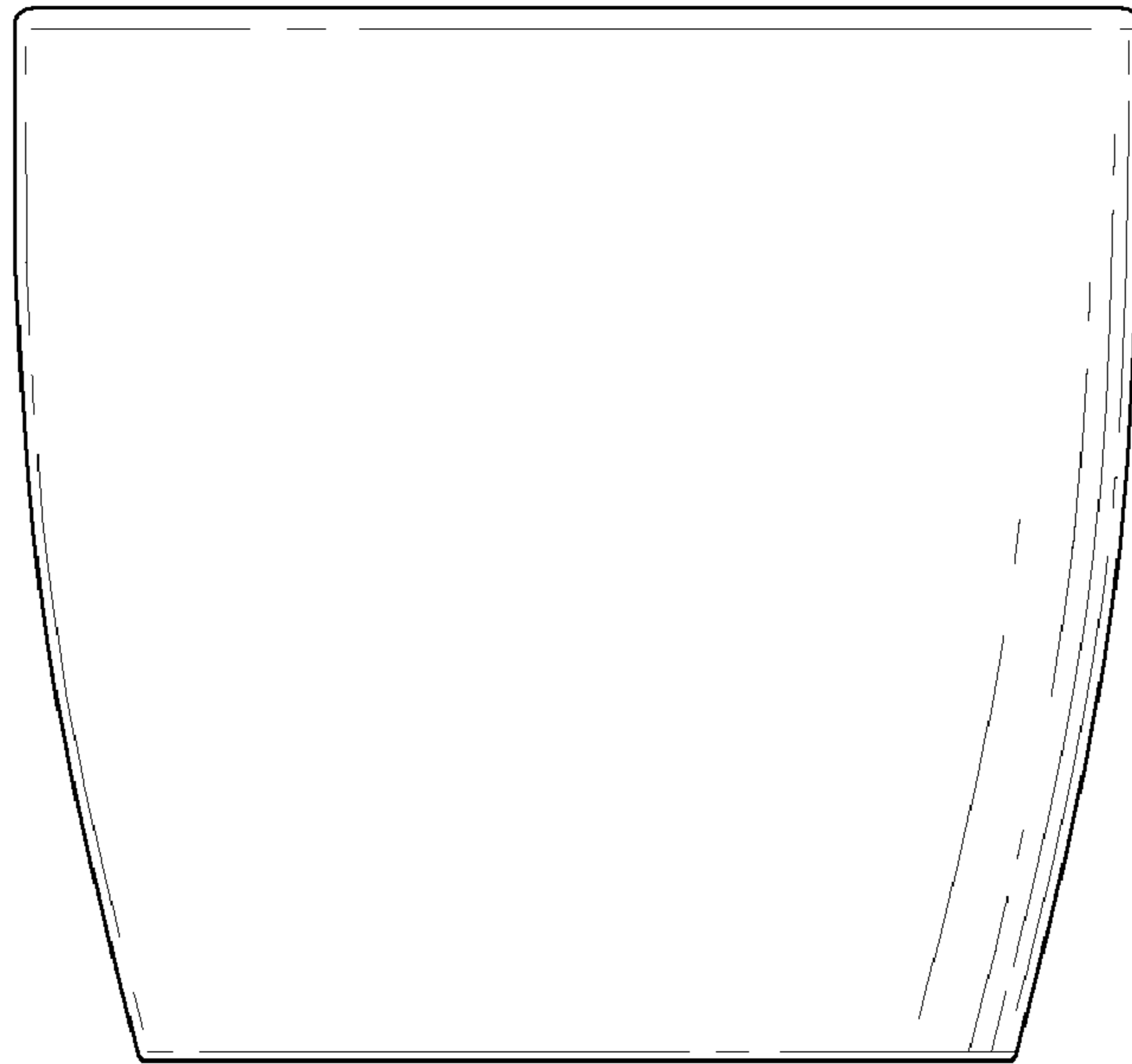

FIG. 29

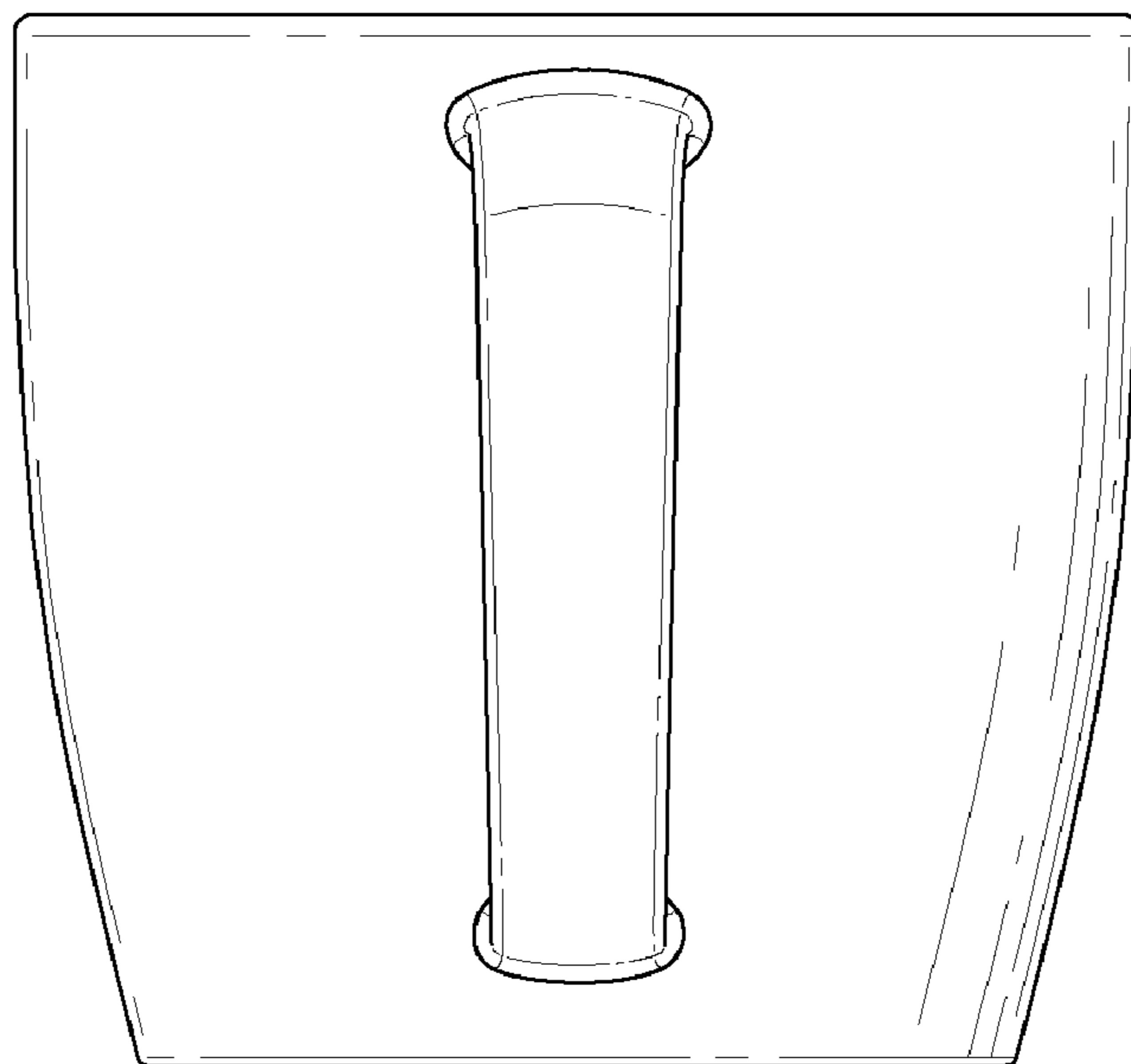

FIG. 30

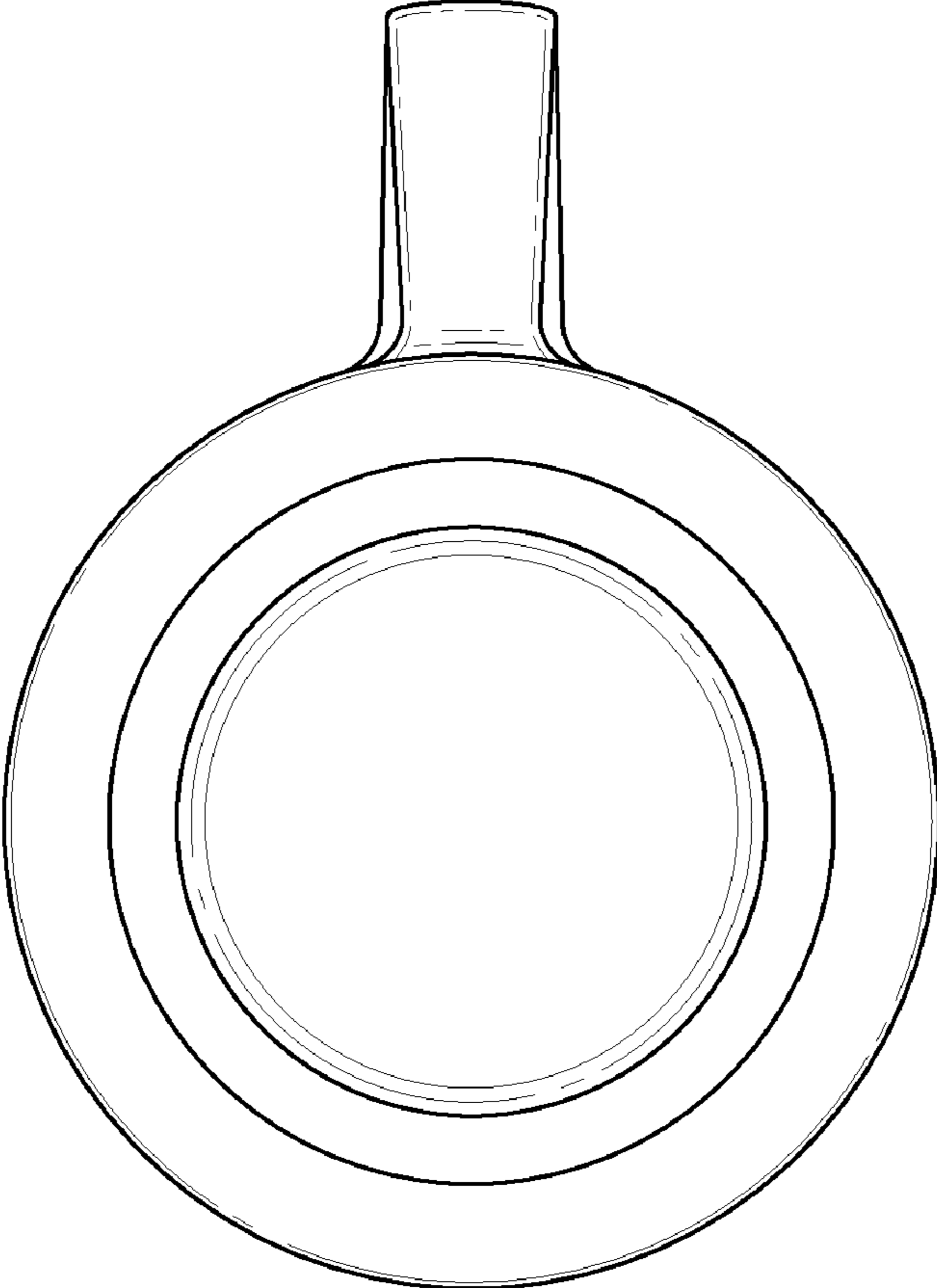

FIG. 31

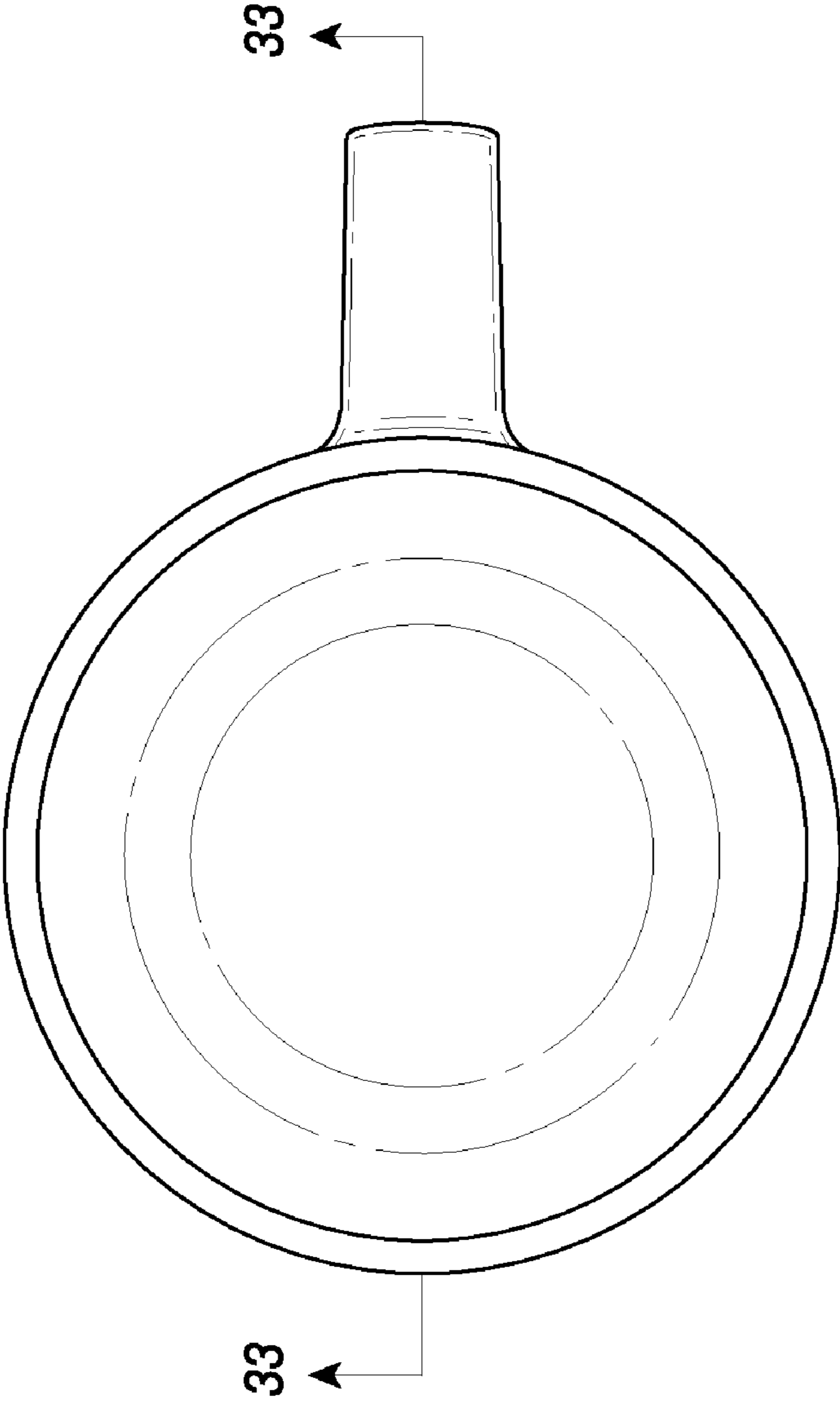

FIG. 32

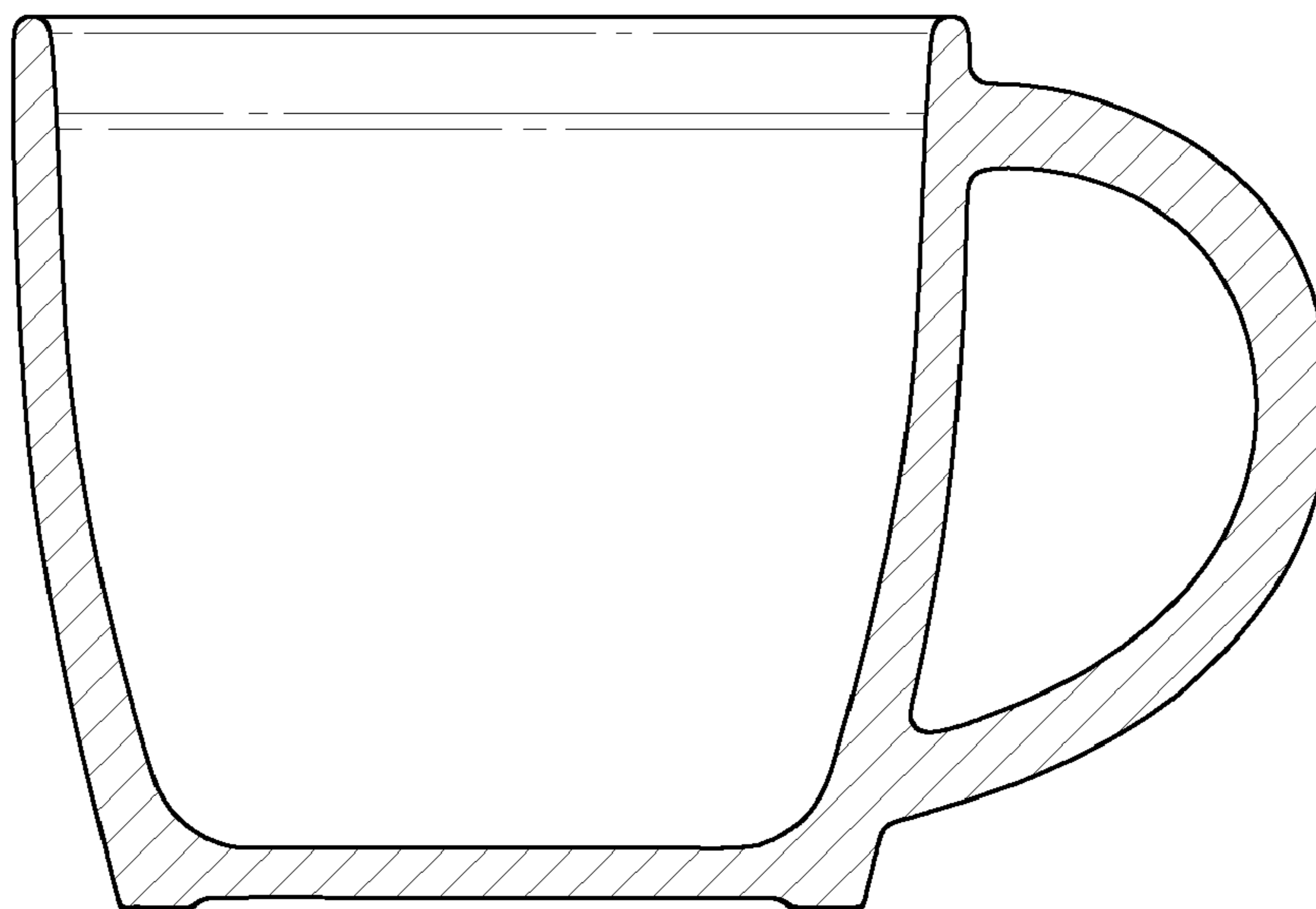

FIG.33



FIG.34

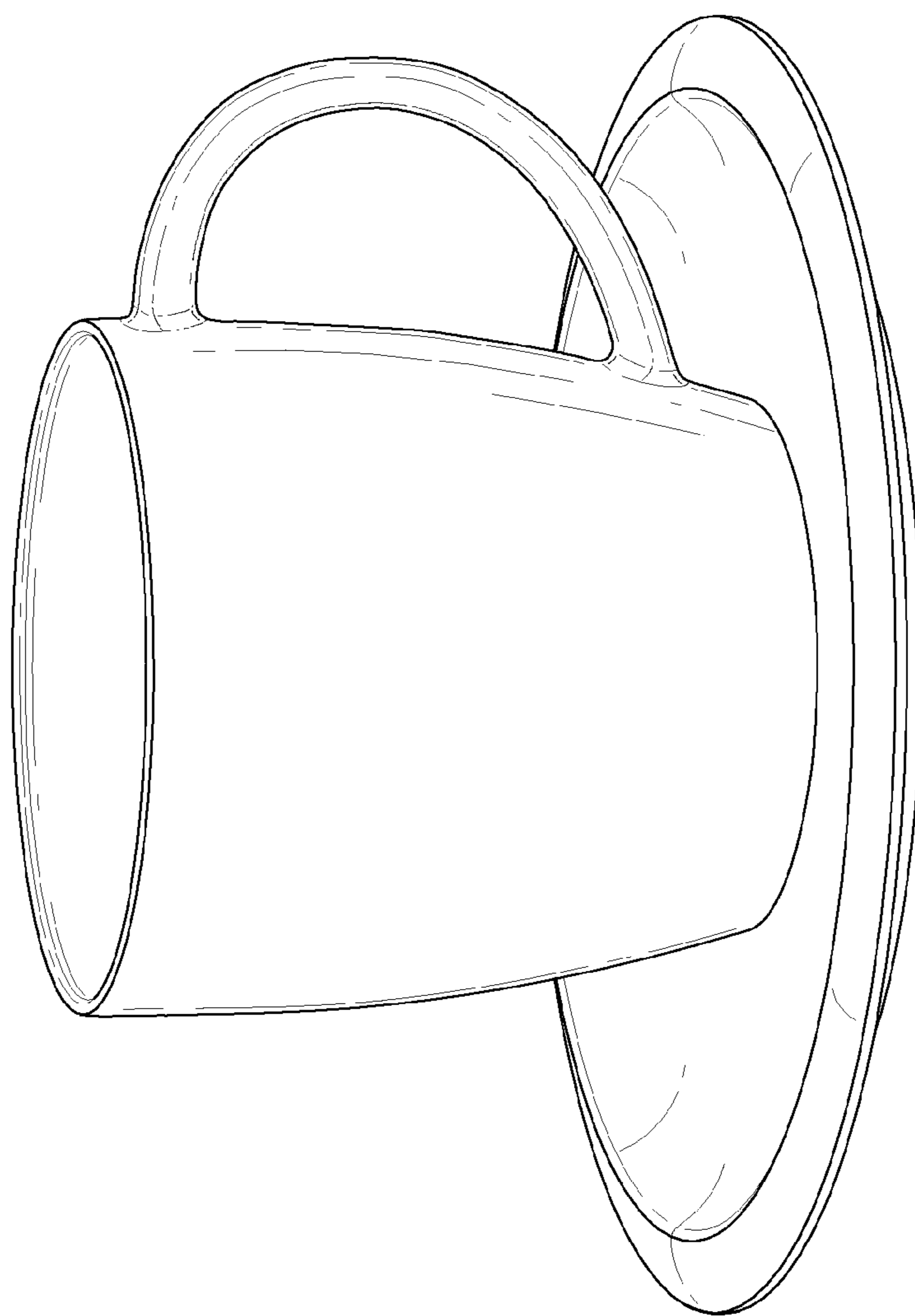

FIG. 35



FIG. 36

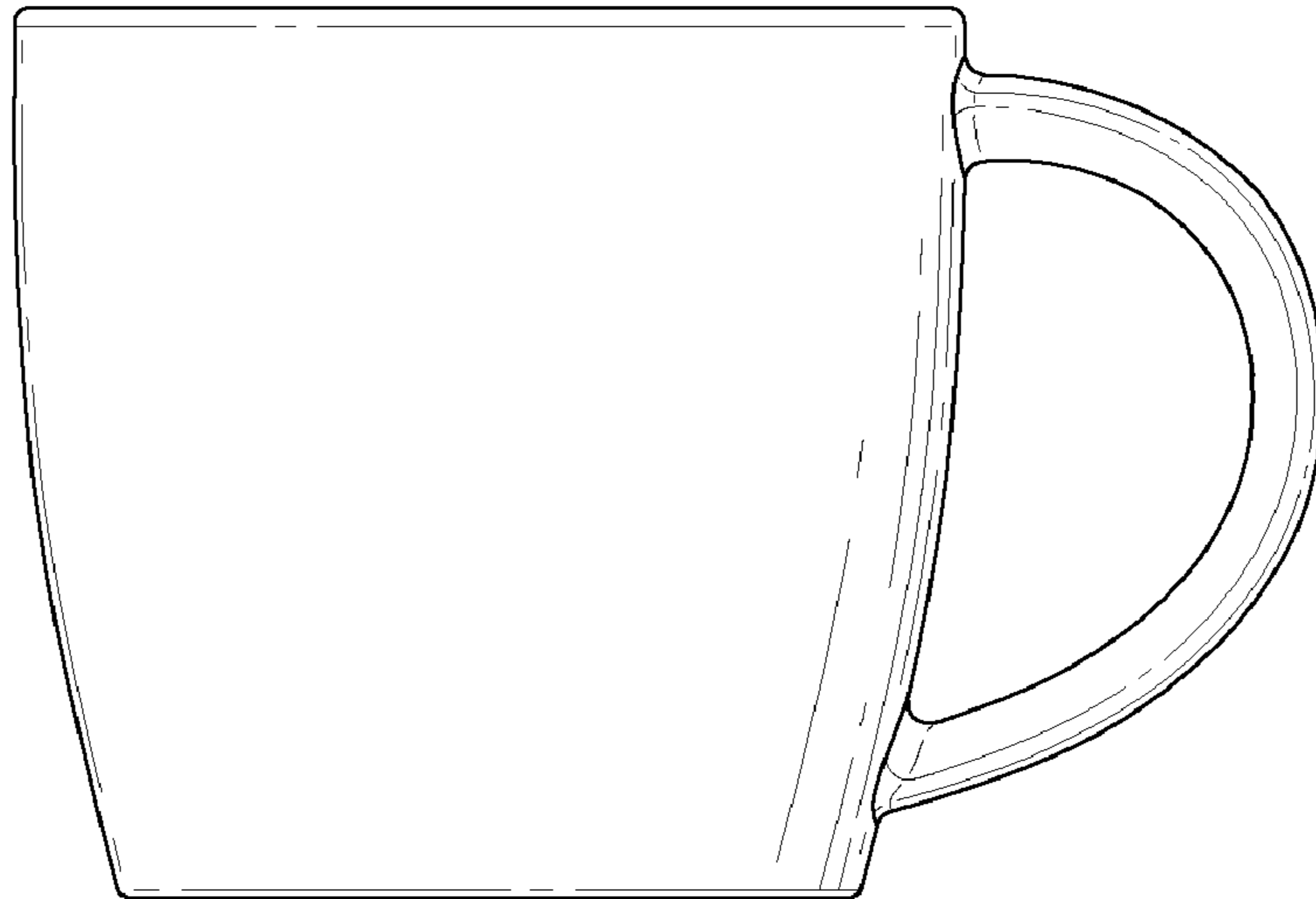

FIG.37

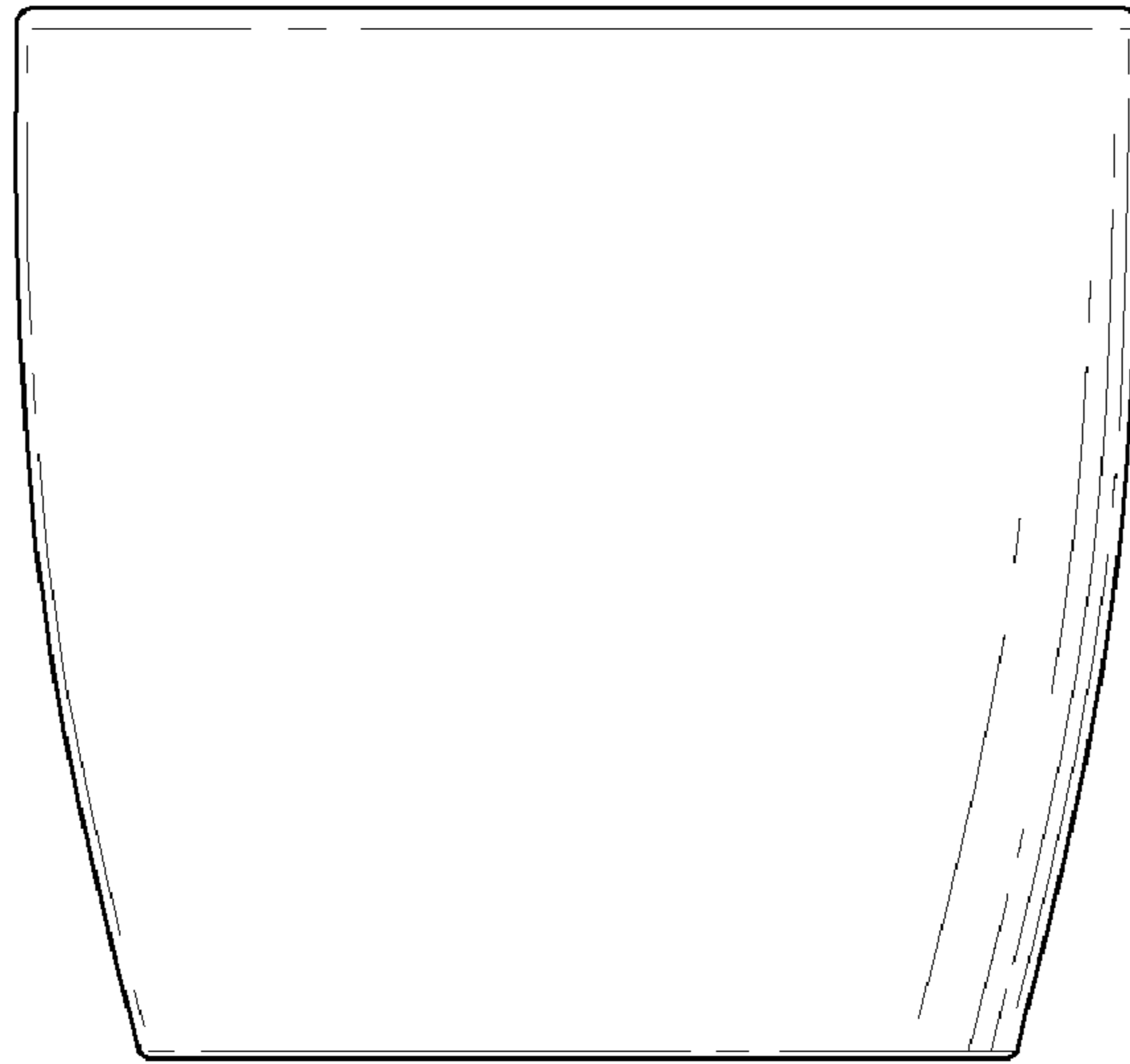

FIG. 38

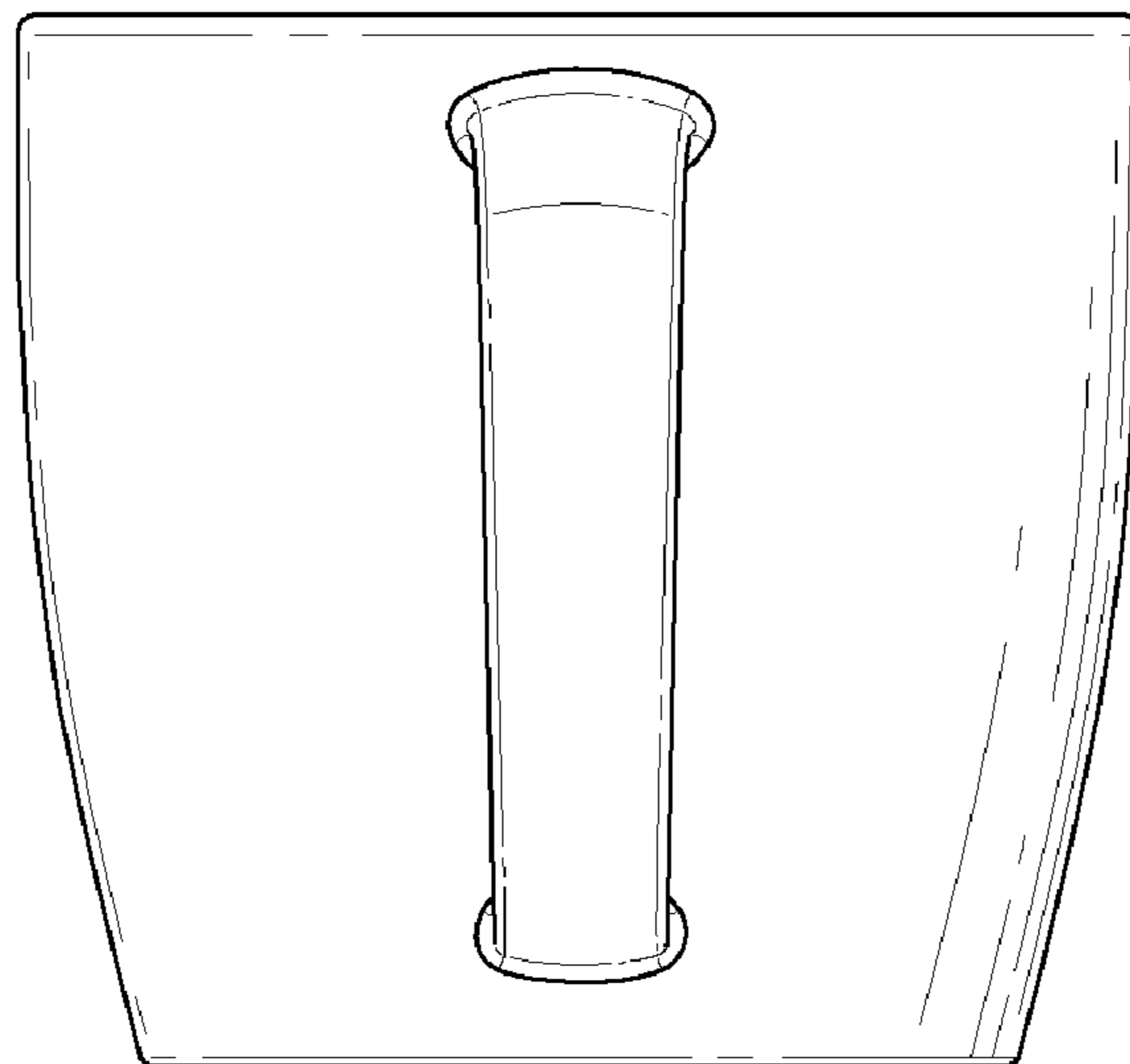

FIG. 39

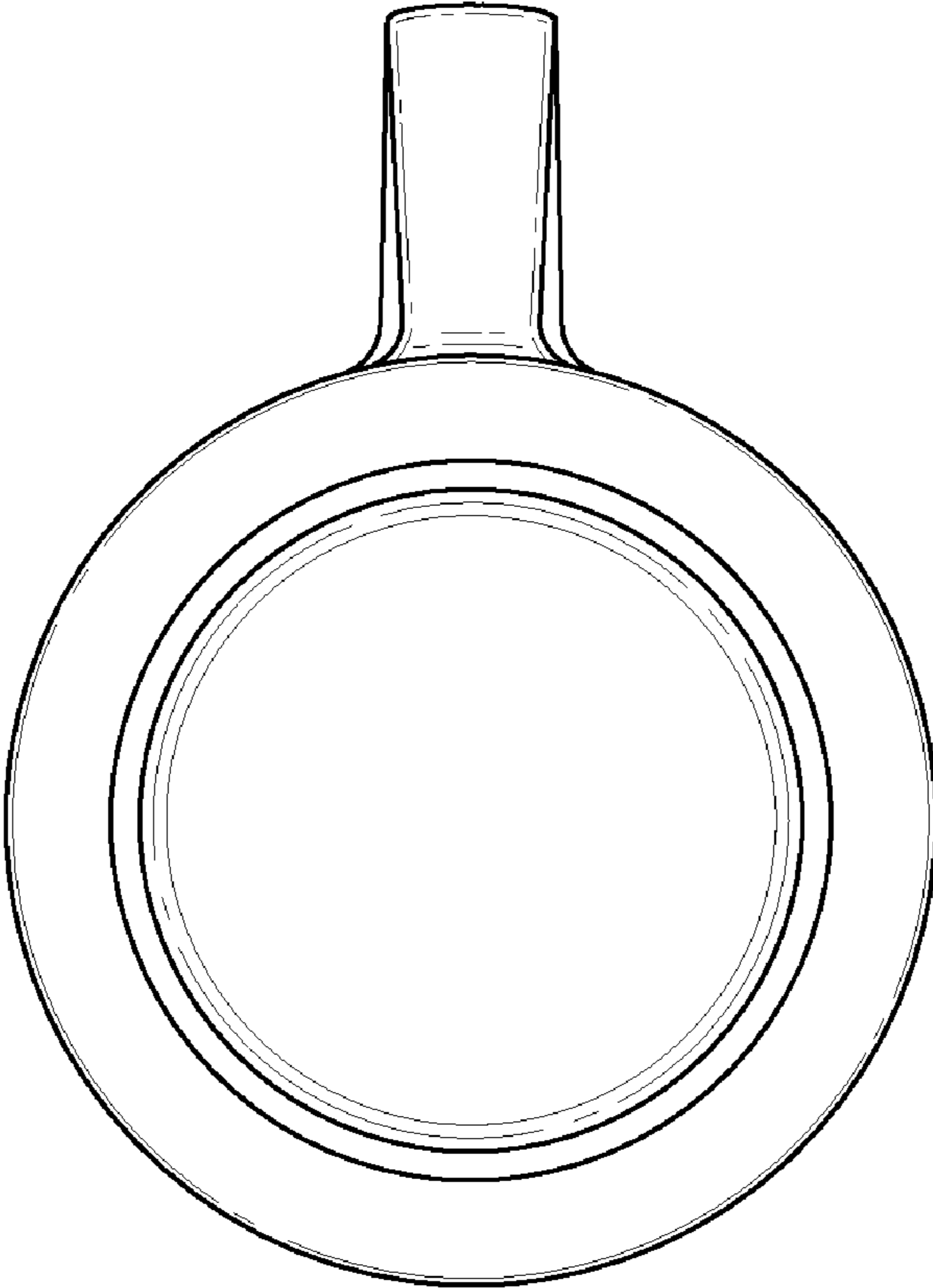

FIG. 40

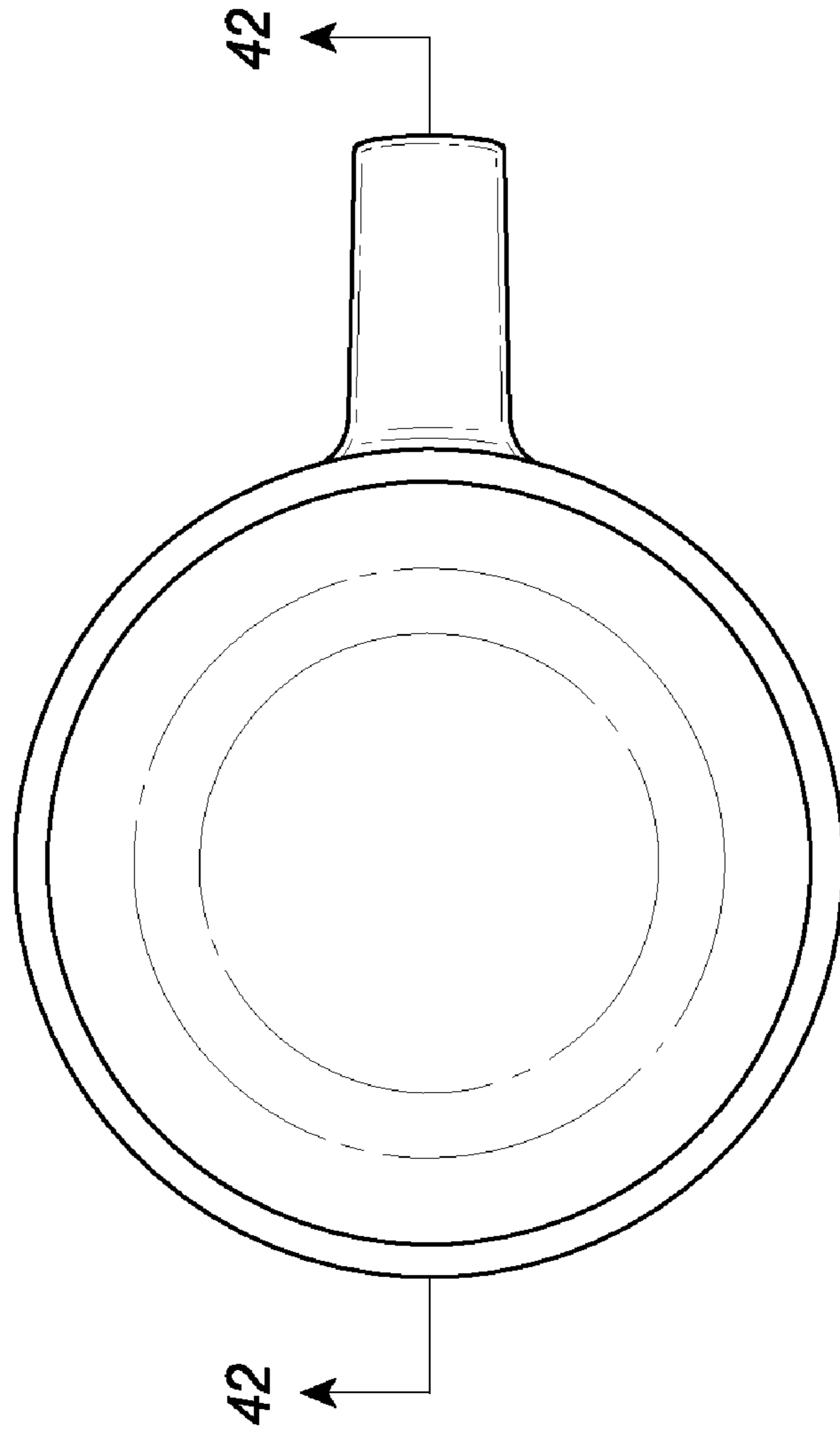

FIG.41

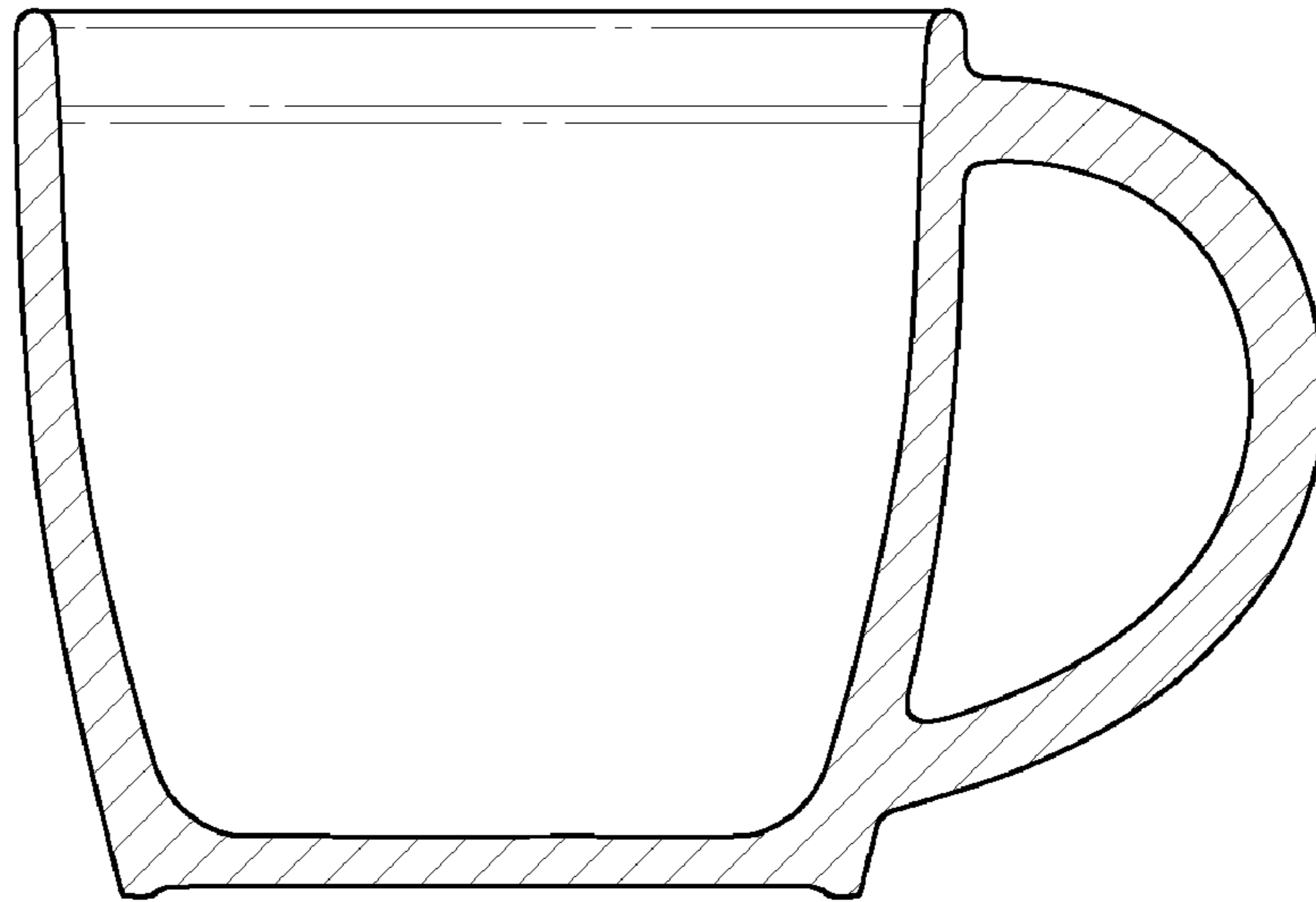

FIG. 42



FIG.43

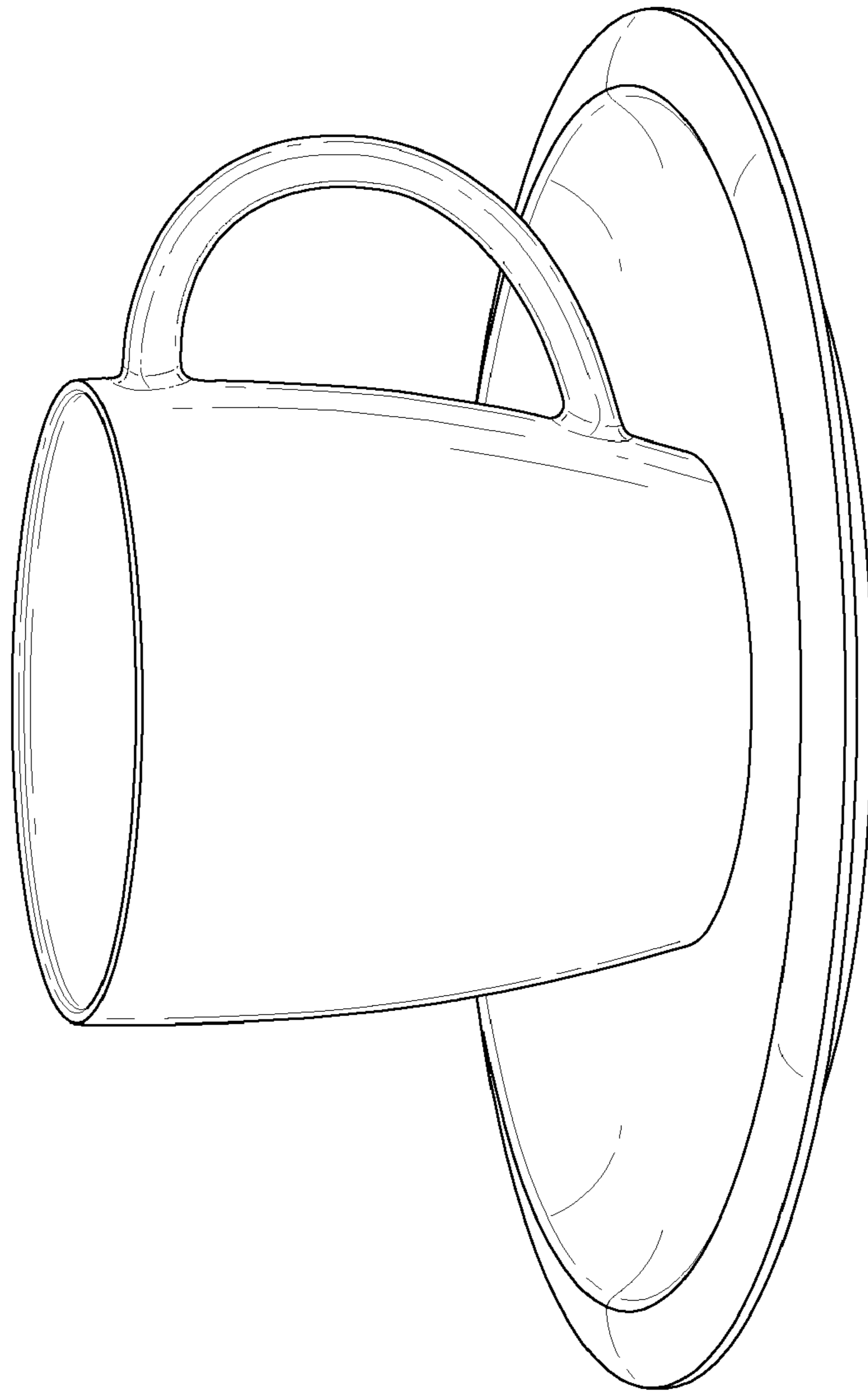

FIG. 44



FIG. 45

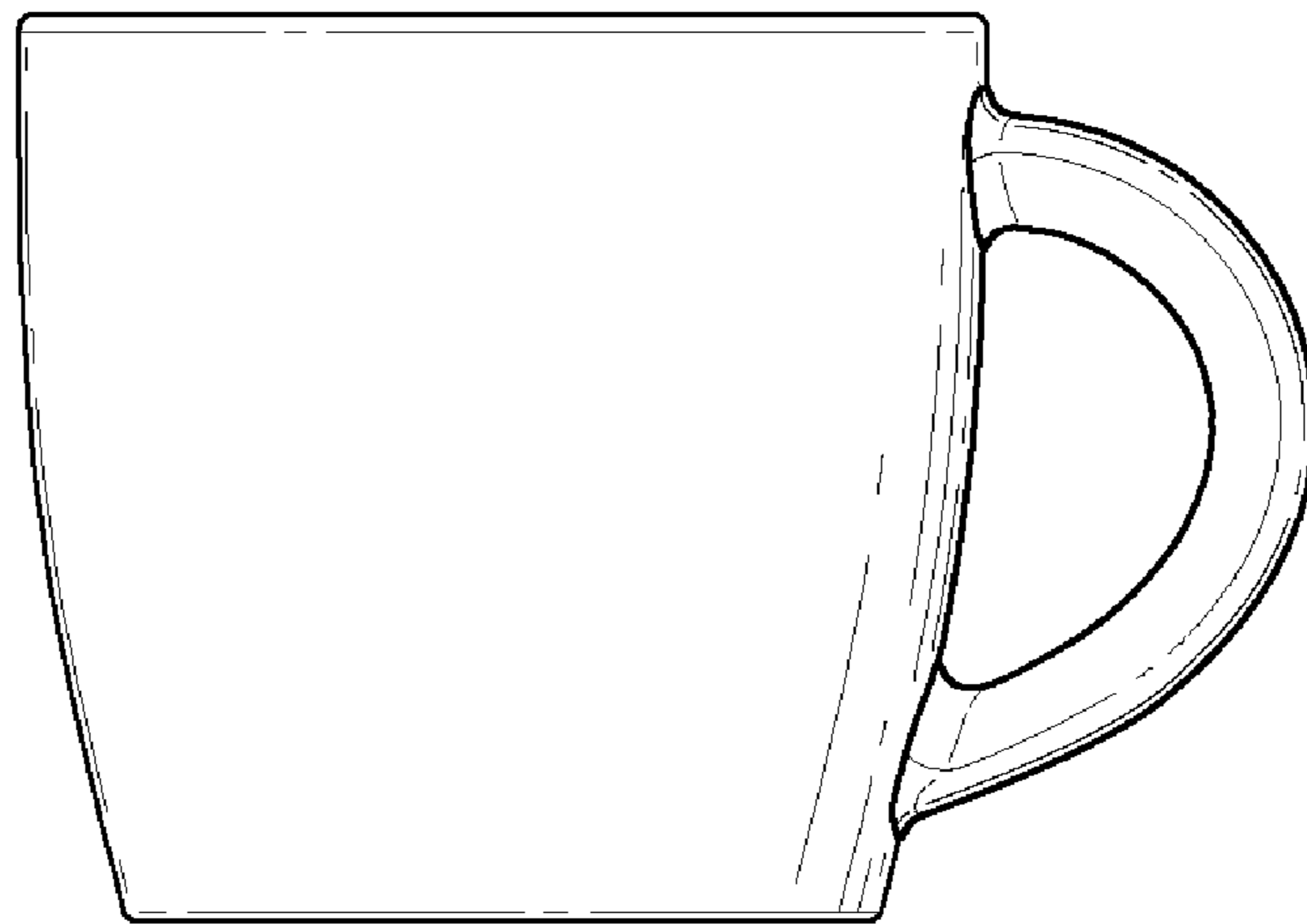

FIG.46

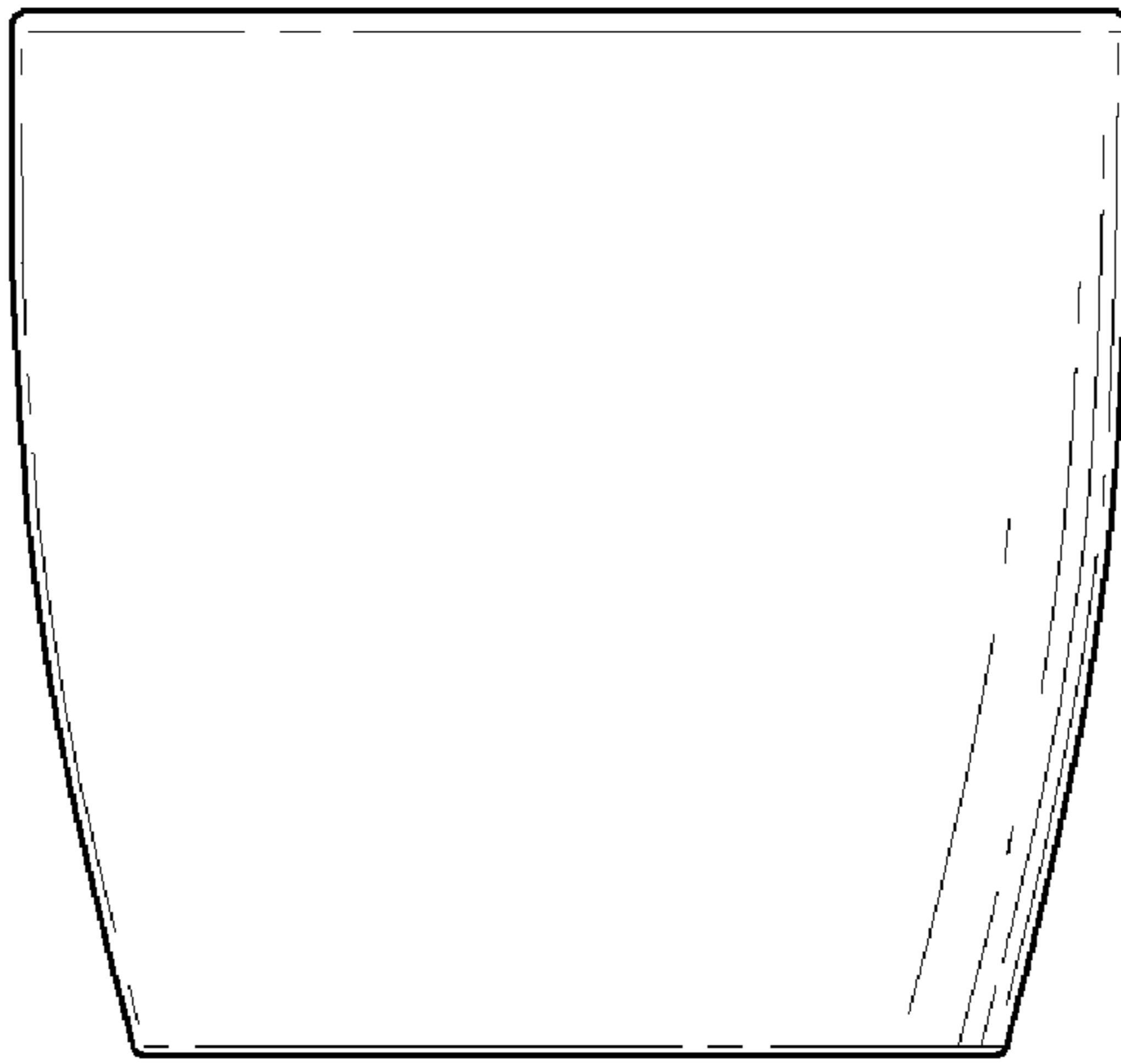

FIG. 47

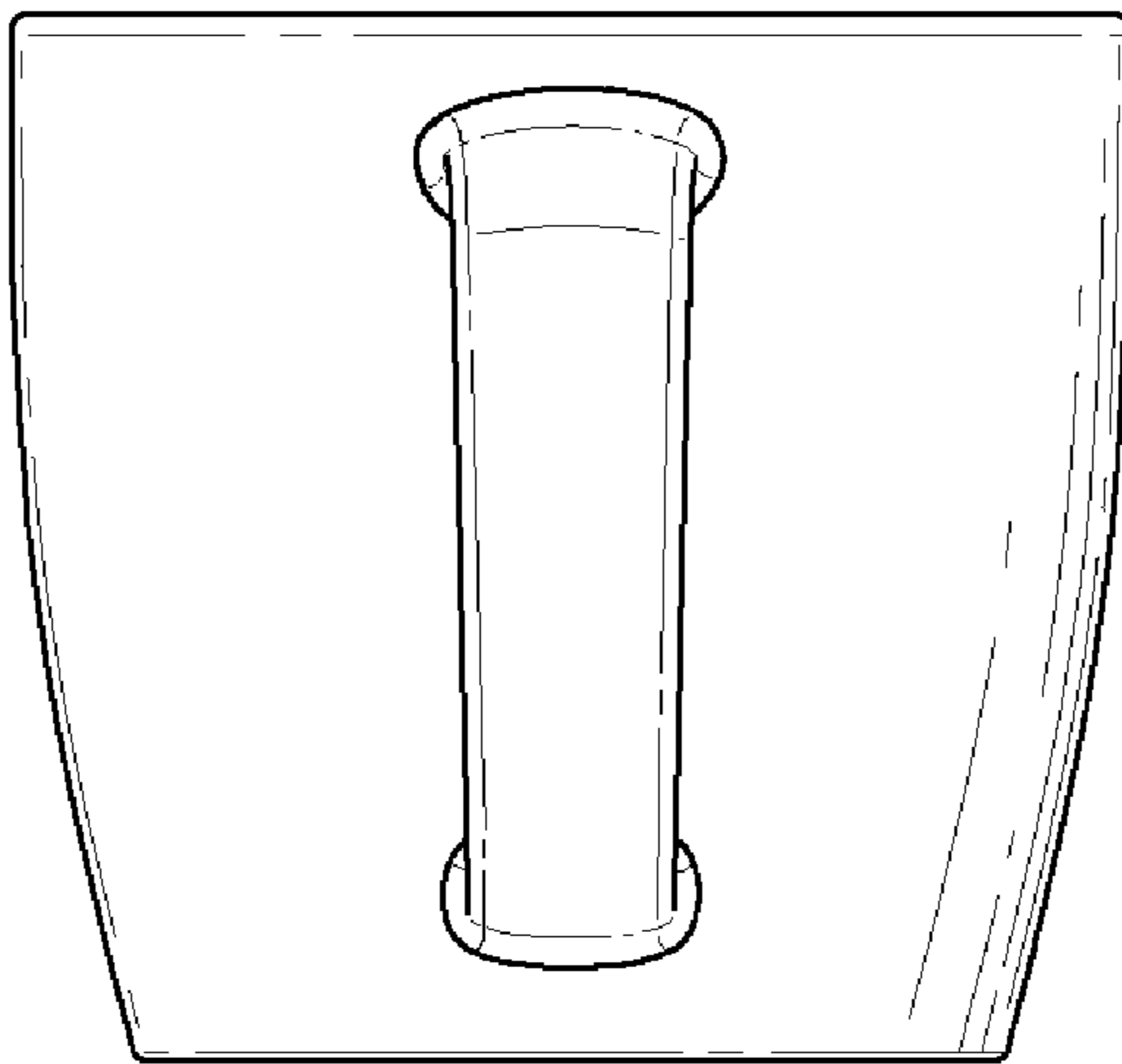

FIG. 48

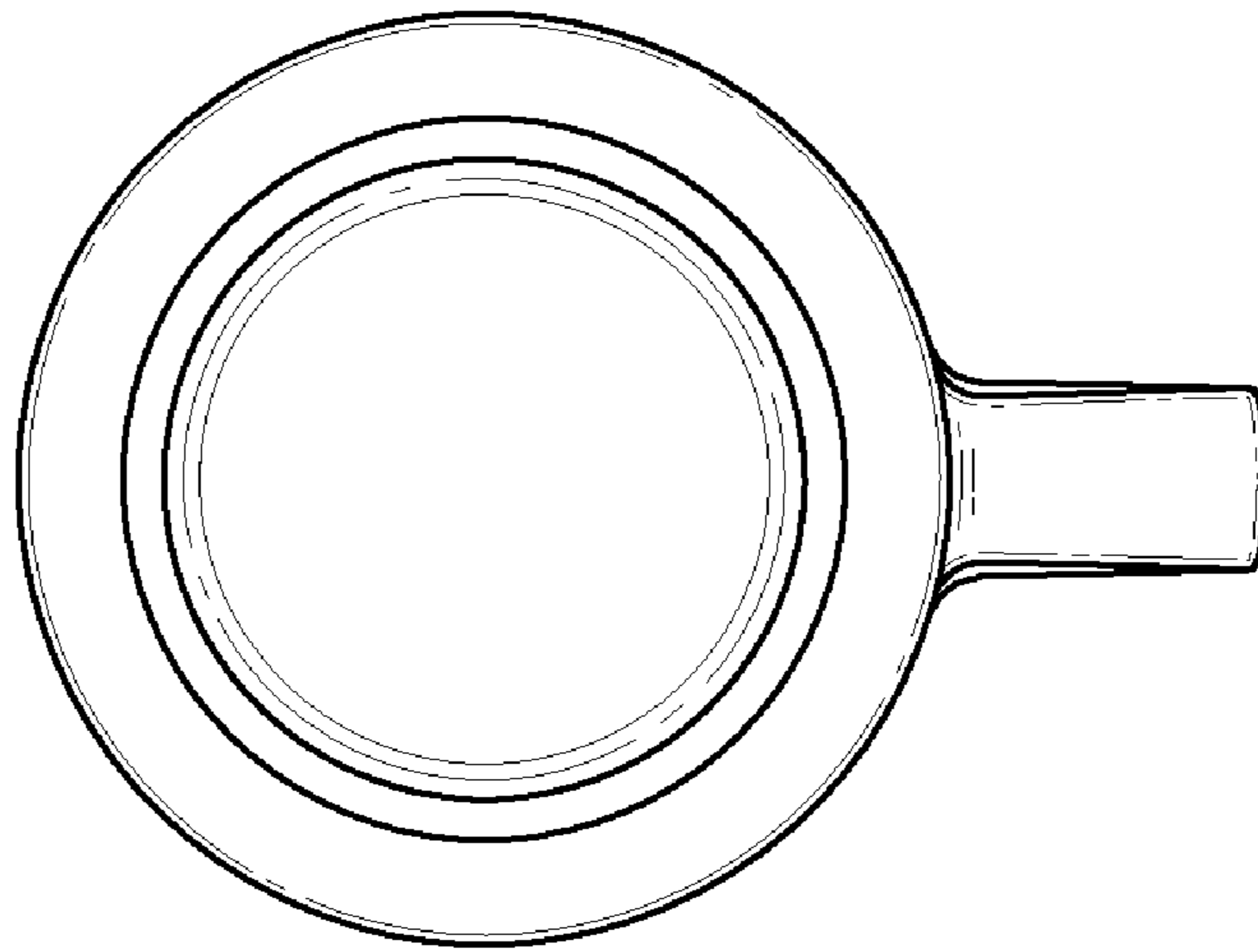

FIG. 49

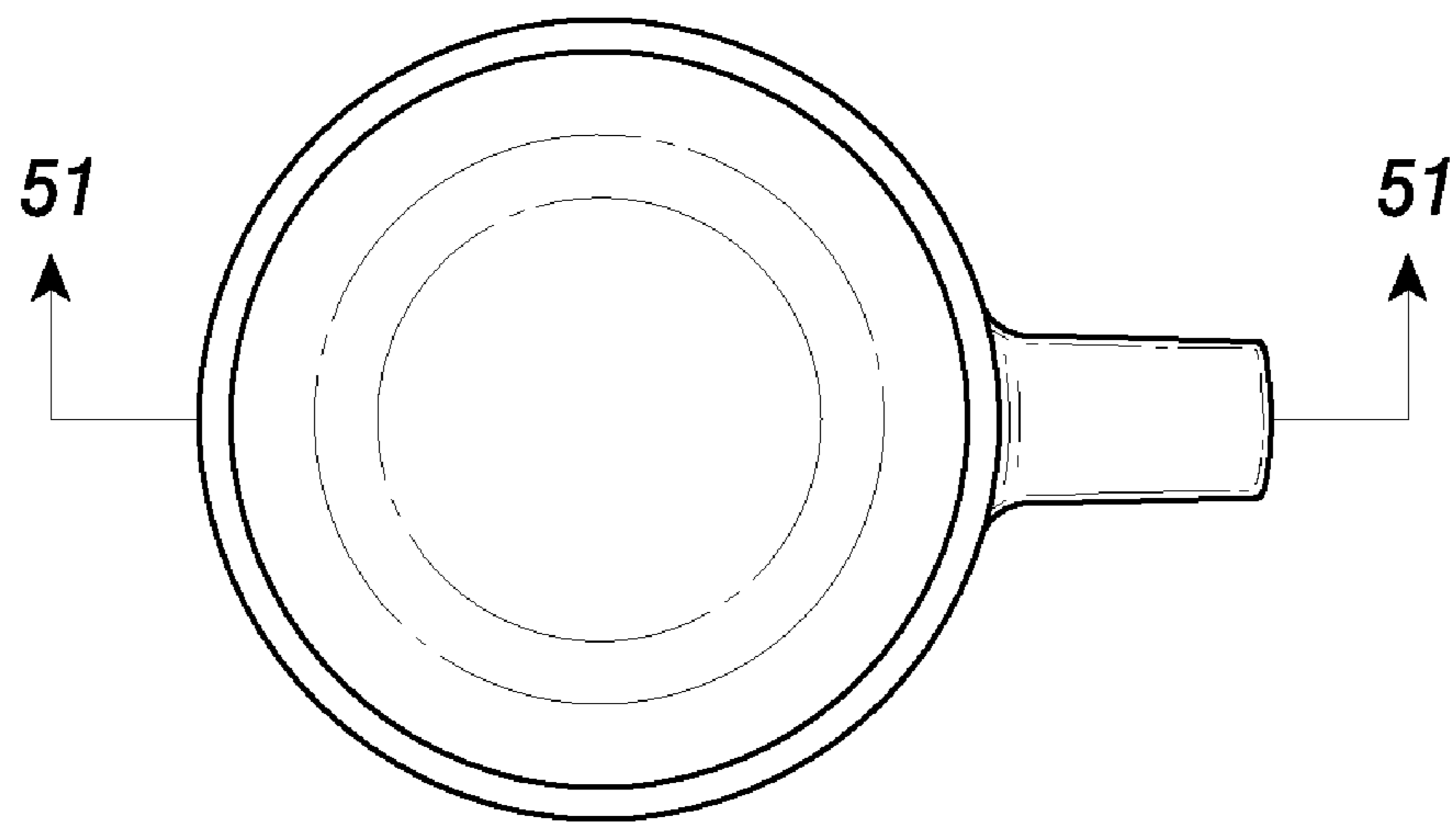

FIG. 50

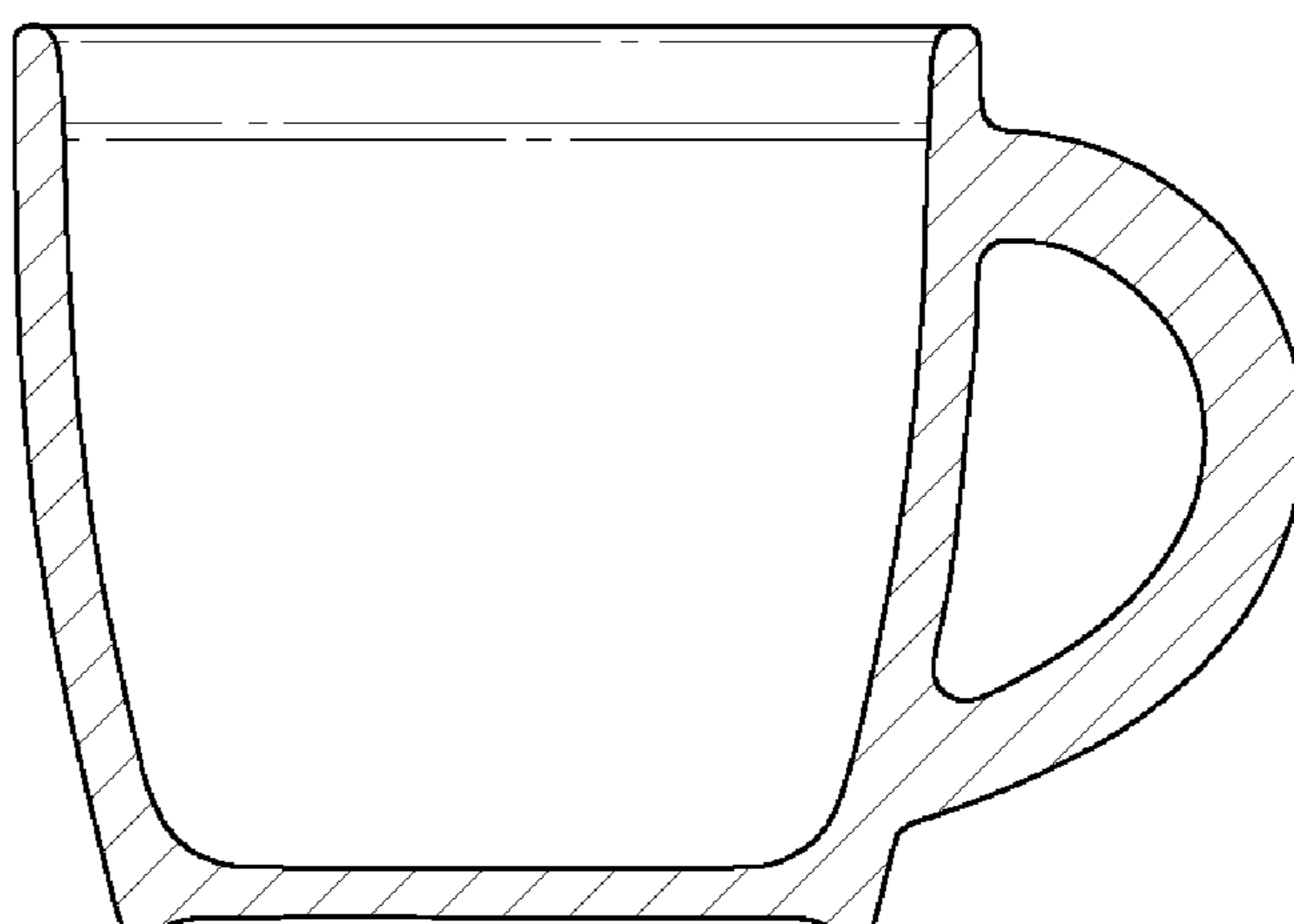

FIG.51

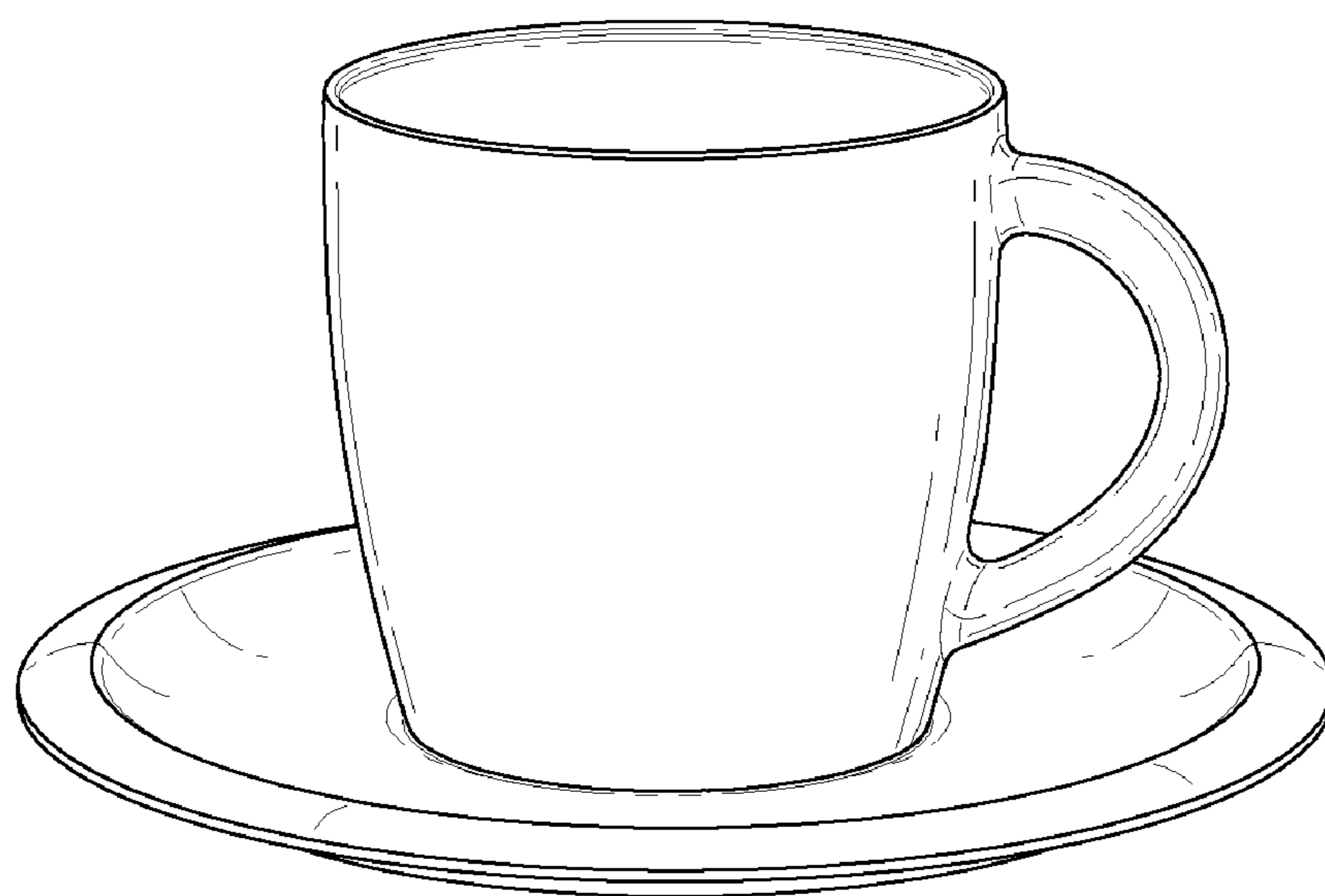

FIG.52

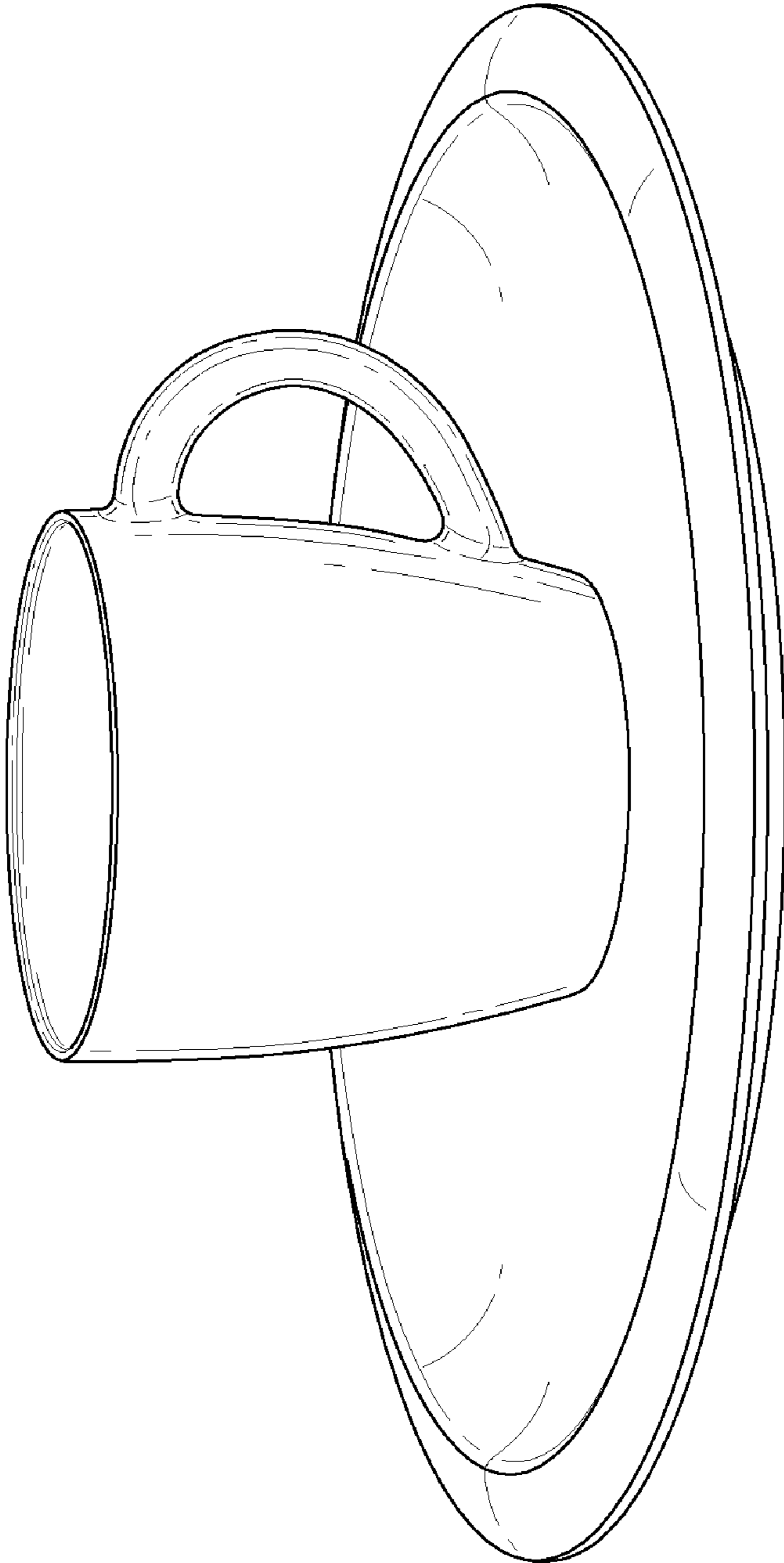

FIG. 53

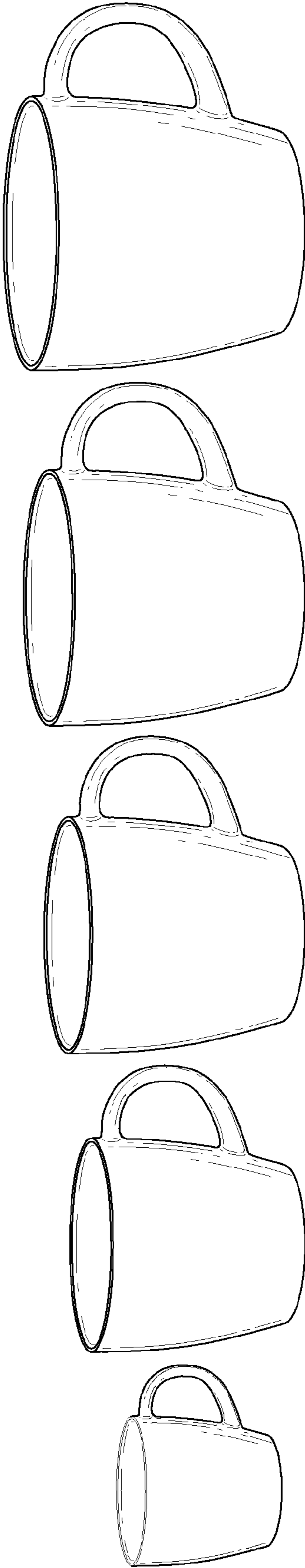

FIG. 54

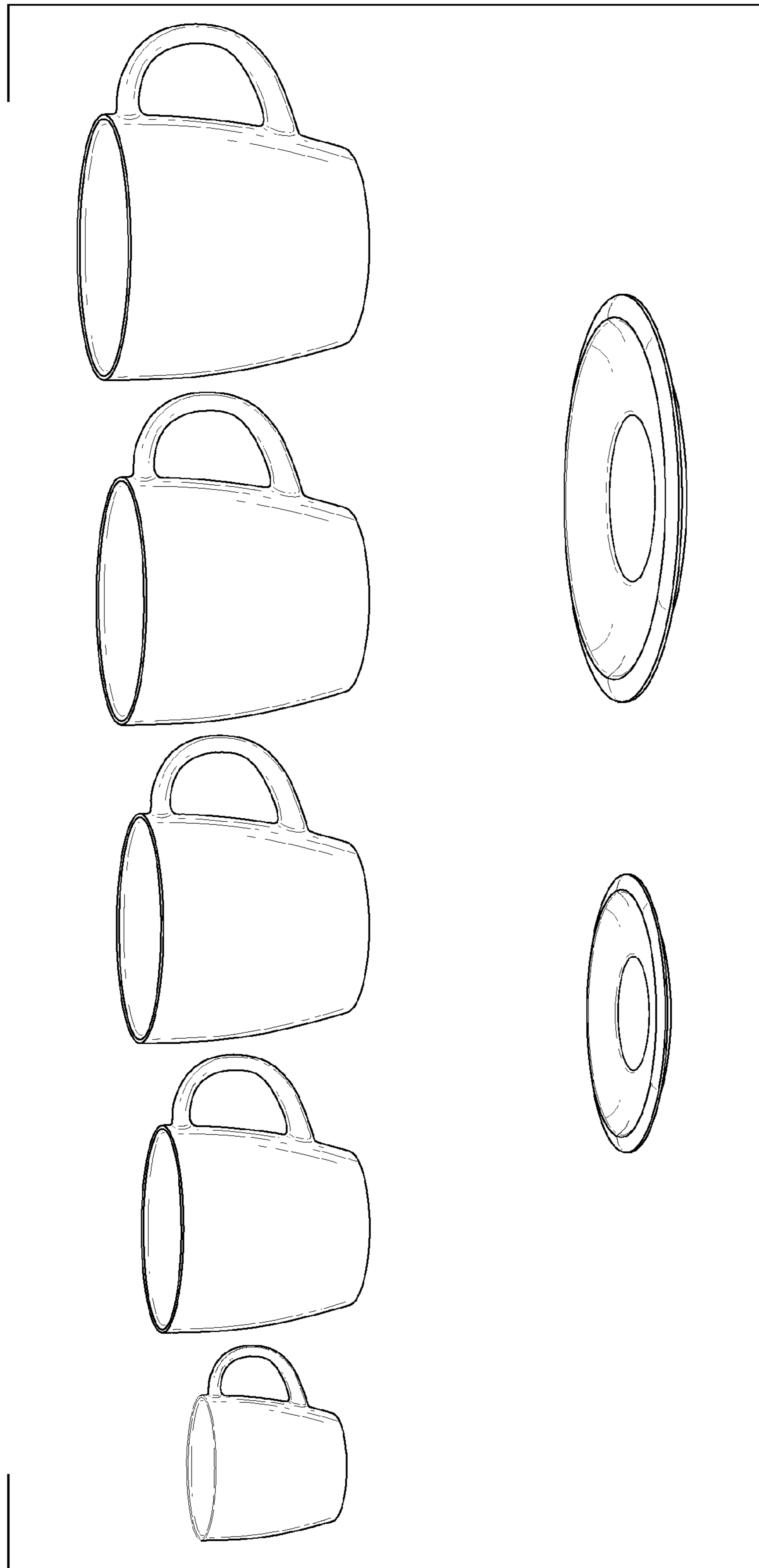

FIG. 55