



US00D646119S

(12) **United States Design Patent**
Deuber

(10) **Patent No.:** **US D646,119 S**

(45) **Date of Patent:** **** Oct. 4, 2011**

(54) **CARTRIDGE FOR COFFEE MACHINE**

(75) Inventor: **Louis Deuber**, Richterswil (CH)

(73) Assignee: **Luna Technology Systems LTS GmbH**,
St. Gallen (CH)

(**) Term: **14 Years**

(21) Appl. No.: **29/360,879**

(22) Filed: **May 1, 2010**

(30) **Foreign Application Priority Data**

Nov. 2, 2009 (CH) 2009-00797

(51) **LOC (9) Cl.** **07-99**

(52) **U.S. Cl.** **D7/400; D7/538; D7/540; D7/601**

(58) **Field of Classification Search** D7/540,
D7/584, 400, 399, 538, 601; D6/515; D3/302;
D9/734, 424; 99/322, 304, 295; 210/474;
220/781, 792; 206/508, 524.1; 426/80
See application file for complete search history.

(56) **References Cited**

U.S. PATENT DOCUMENTS

2,767,878 A * 10/1956 Brown 220/228
D235,621 S * 7/1975 Cawrst D9/425
D248,215 S * 6/1978 Cherry D9/418
4,412,630 A * 11/1983 Daenen 220/792

D330,161 S * 10/1992 Schuh D9/423
D334,499 S * 4/1993 Meisner et al. D6/515
D351,765 S * 10/1994 Beeler et al. D7/629
7,051,550 B2 * 5/2006 Roth et al. 62/457.2
7,063,230 B2 * 6/2006 Ciccone 220/792
D531,802 S * 11/2006 Zimmerman D3/302
D535,478 S * 1/2007 Uffner et al. D3/302
D600,111 S * 9/2009 Gerulski et al. D9/424
D618,501 S * 6/2010 Billot et al. D7/400

* cited by examiner

Primary Examiner — Marianne Pandozzi

(74) *Attorney, Agent, or Firm* — Rankin, Hill & Clark LLP

(57) **CLAIM**

We claim the ornamental design for a cartridge for coffee machine, as shown and described.

DESCRIPTION

FIG. 1 is a perspective view, from above, of a cartridge for coffee machine embodying our design;
FIG. 2 is a bottom perspective view thereof;
FIG. 3 is a right side view thereof;
FIG. 4 is a left side view thereof;
FIG. 5 is a front view thereof;
FIG. 6 is a rear view thereof;
FIG. 7 is a top view thereof; and,
FIG. 8 is a rear view thereof.

1 Claim, 4 Drawing Sheets

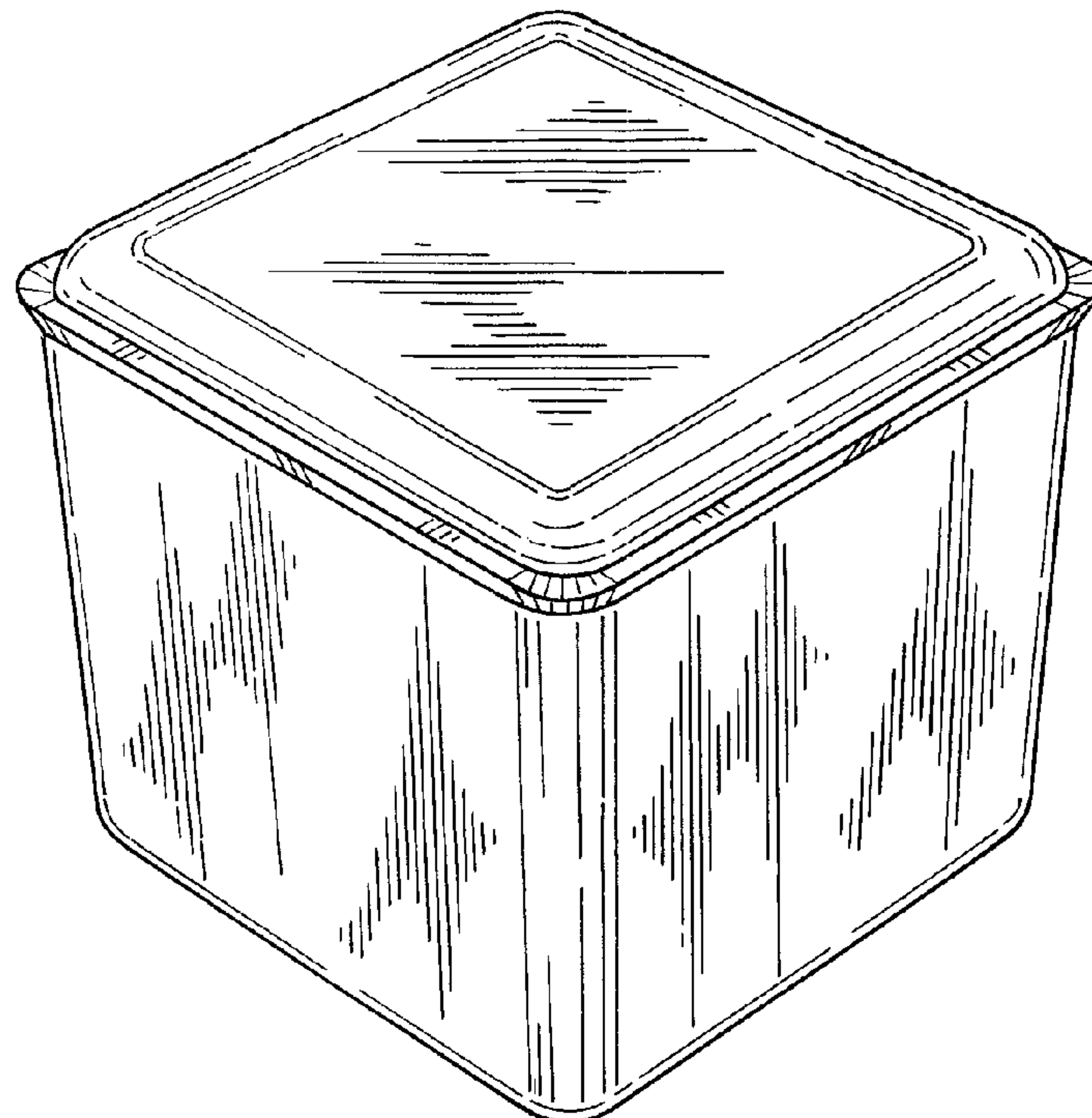

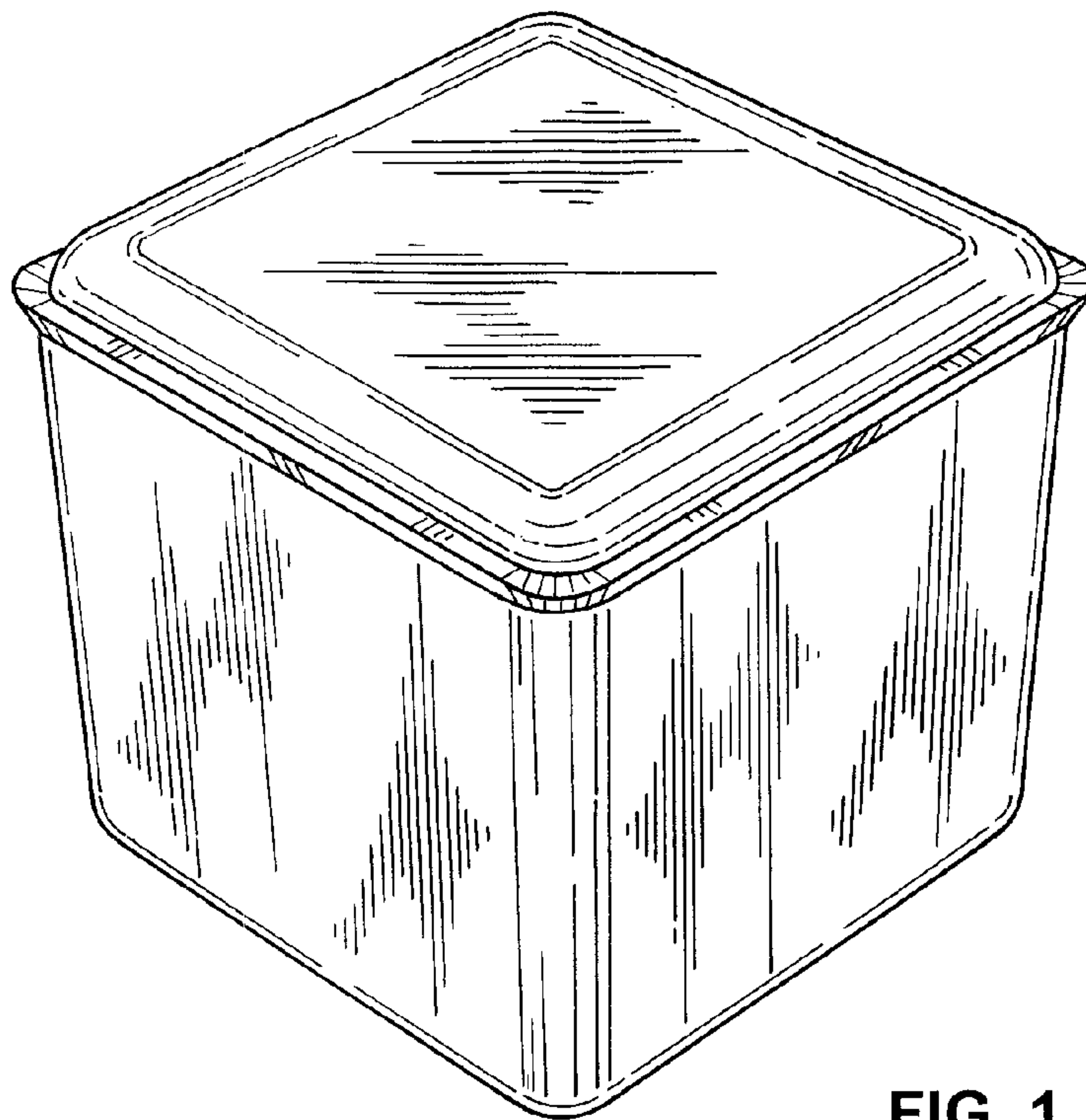

FIG. 1

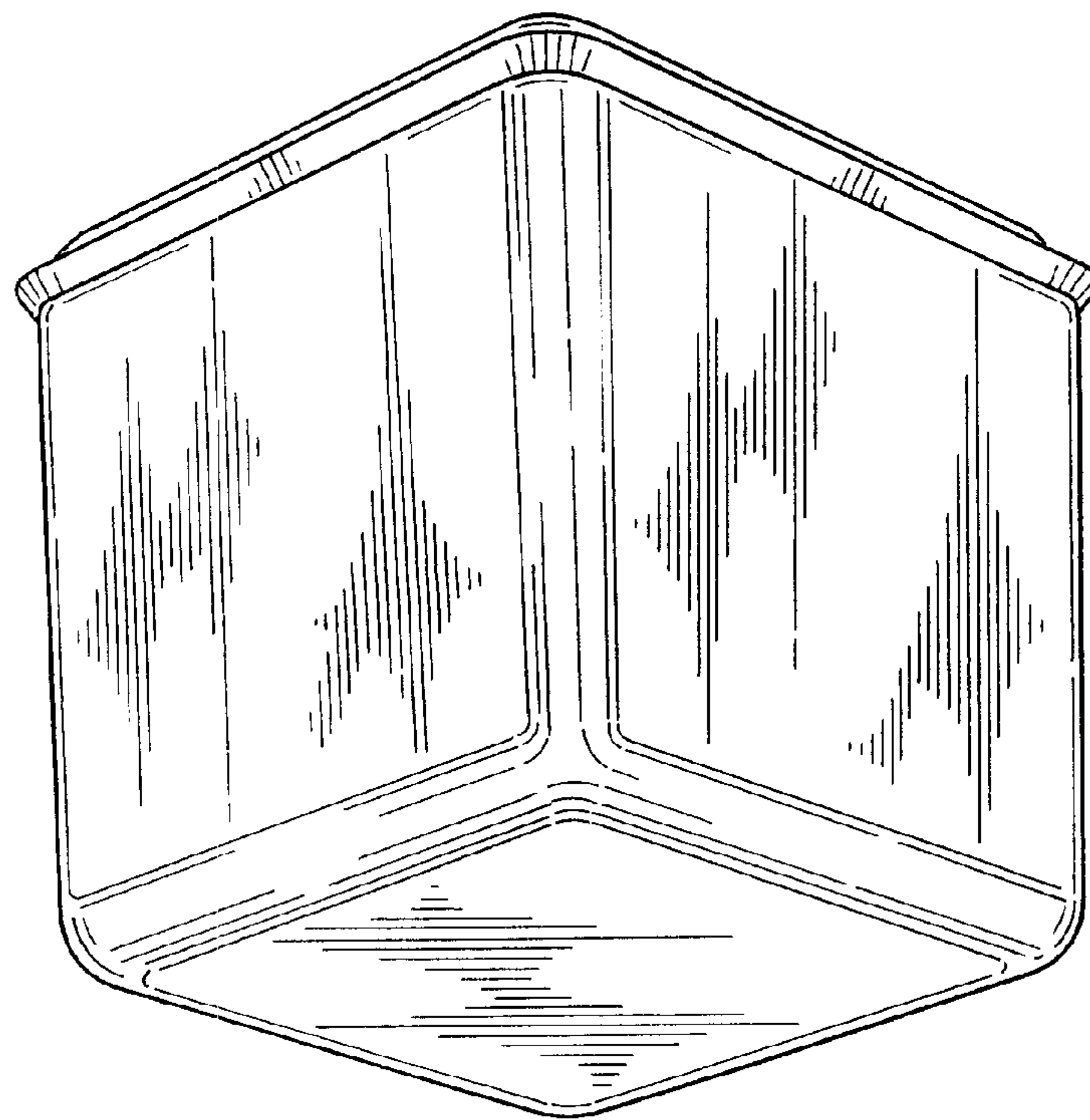

FIG. 2

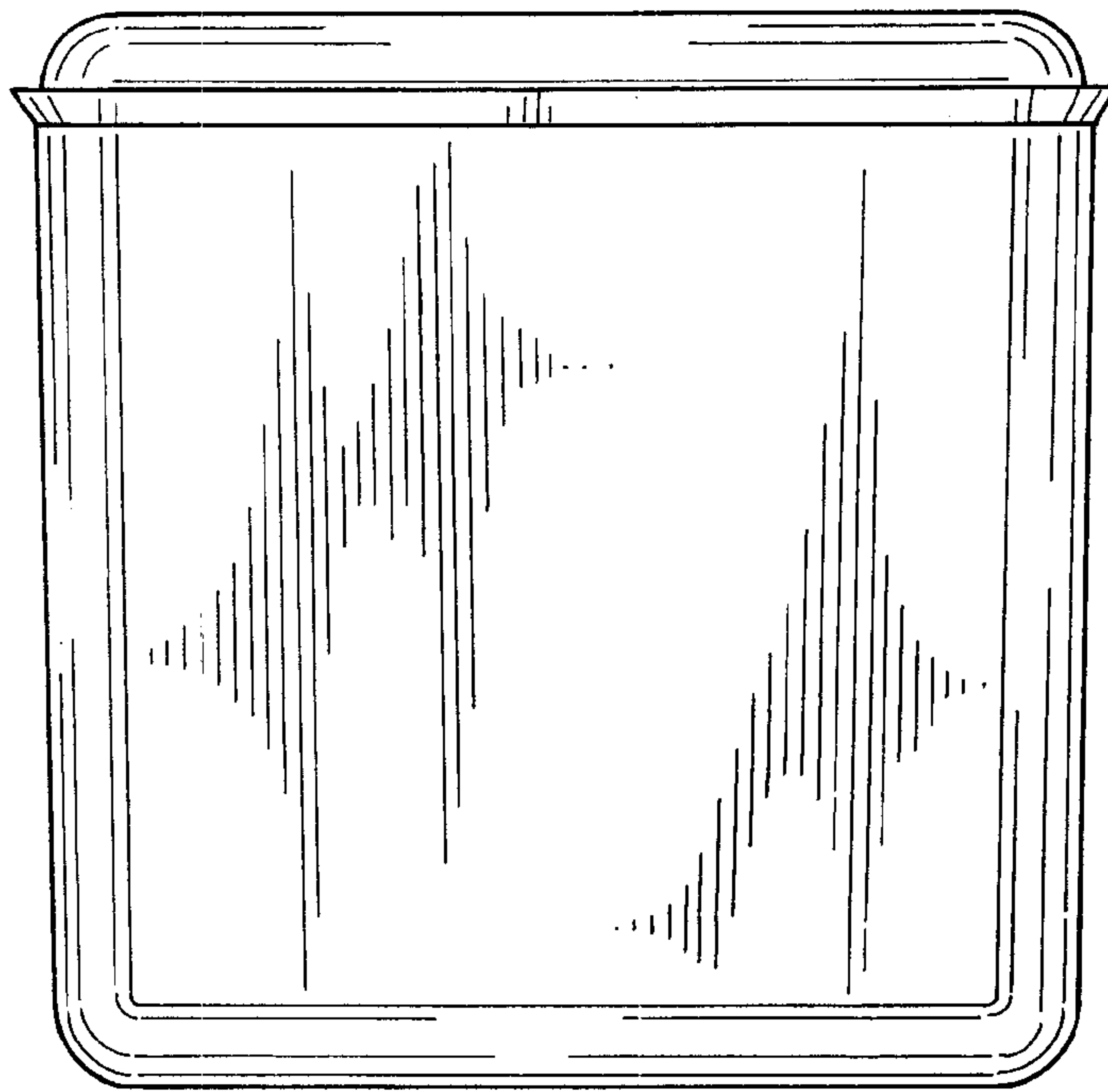

FIG. 3

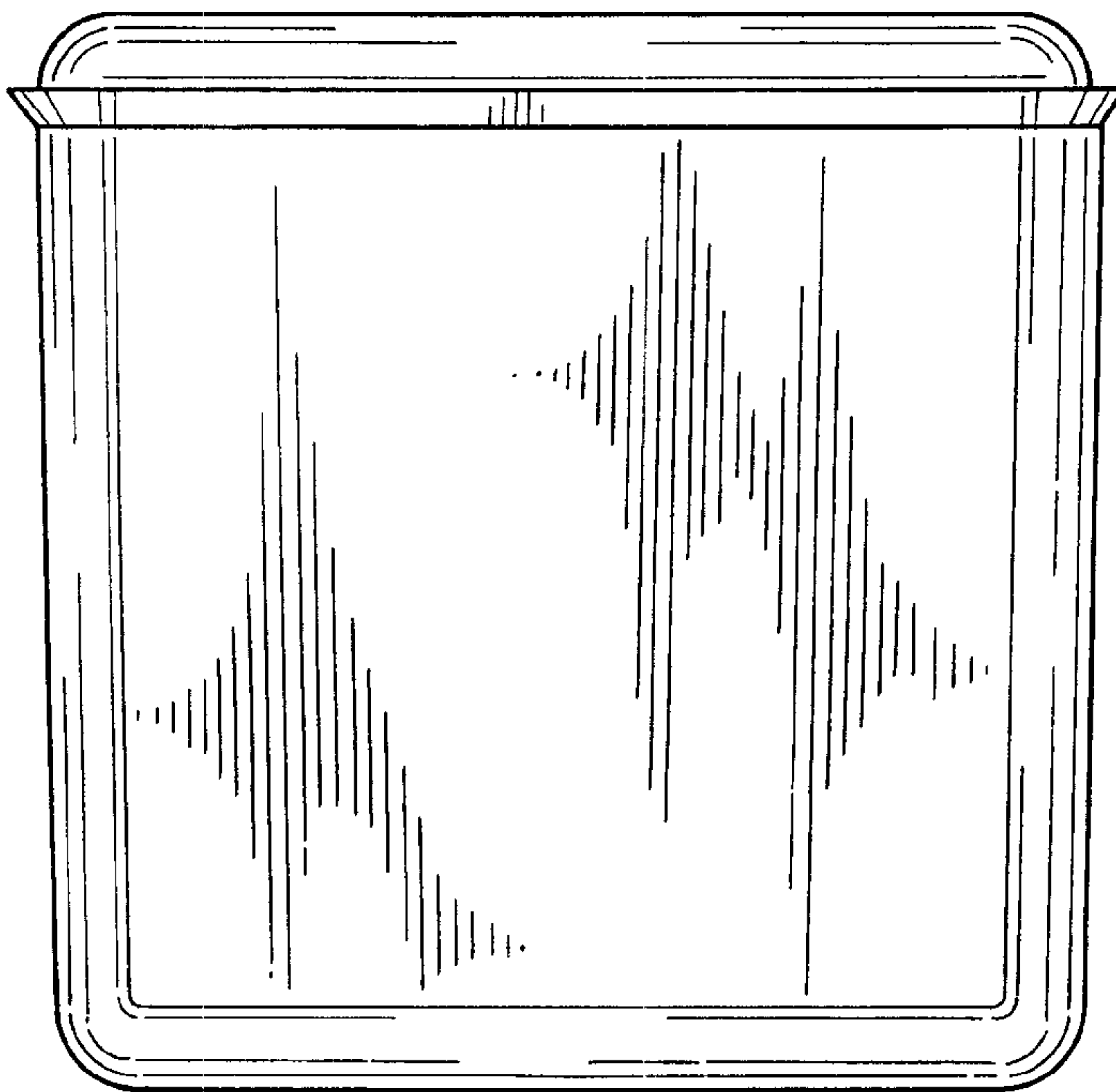

FIG. 4

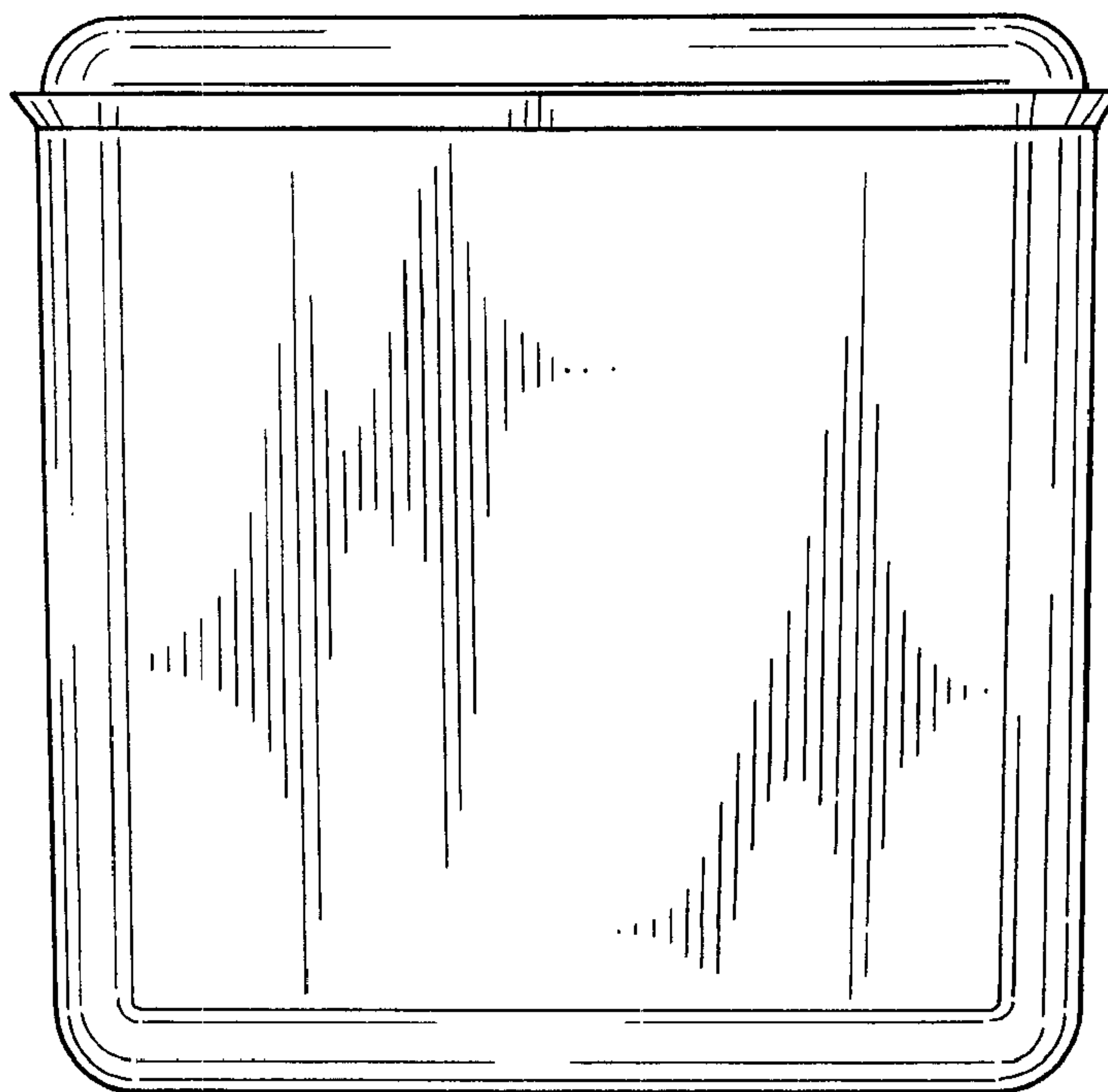

FIG. 5

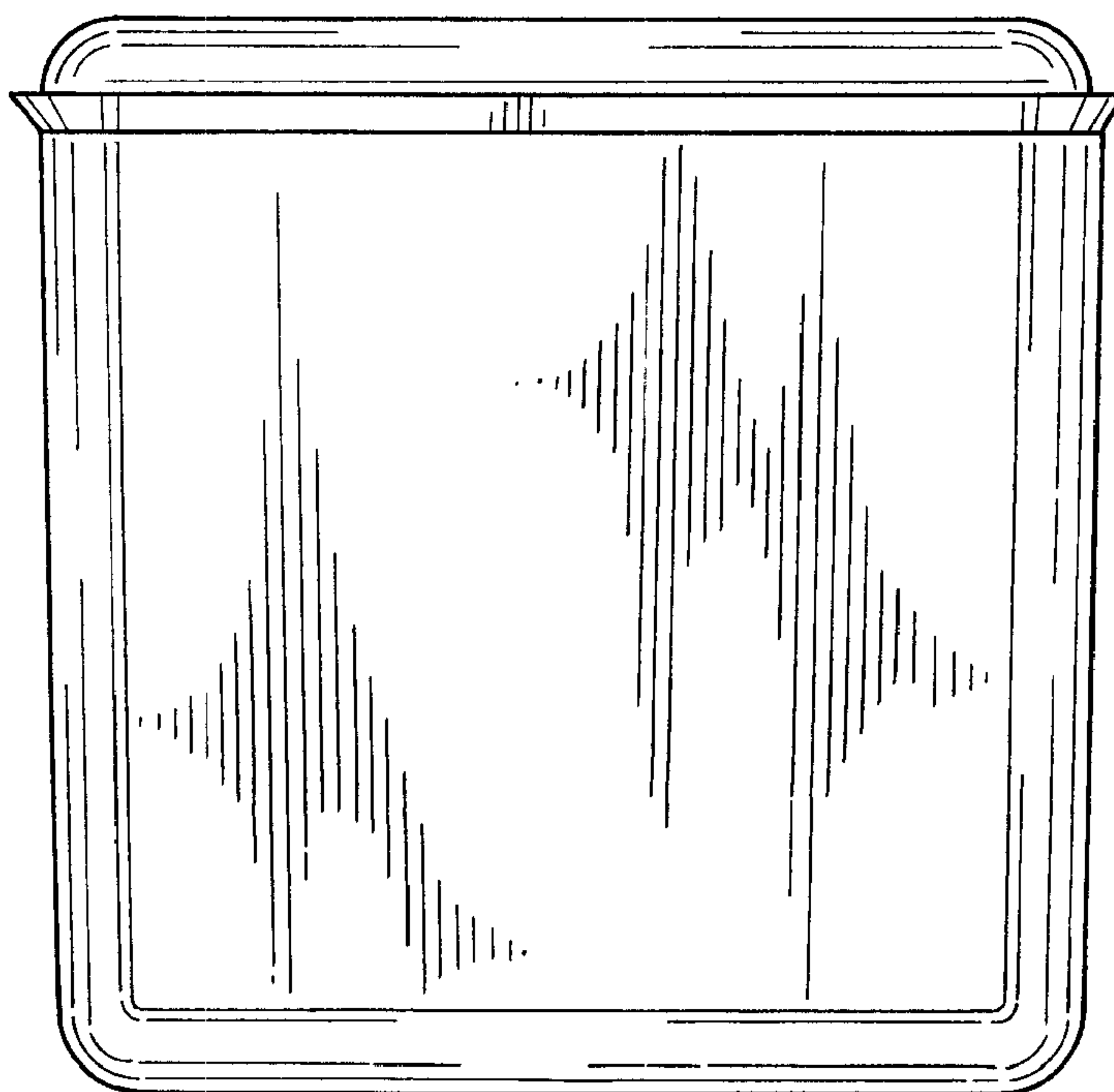

FIG. 6

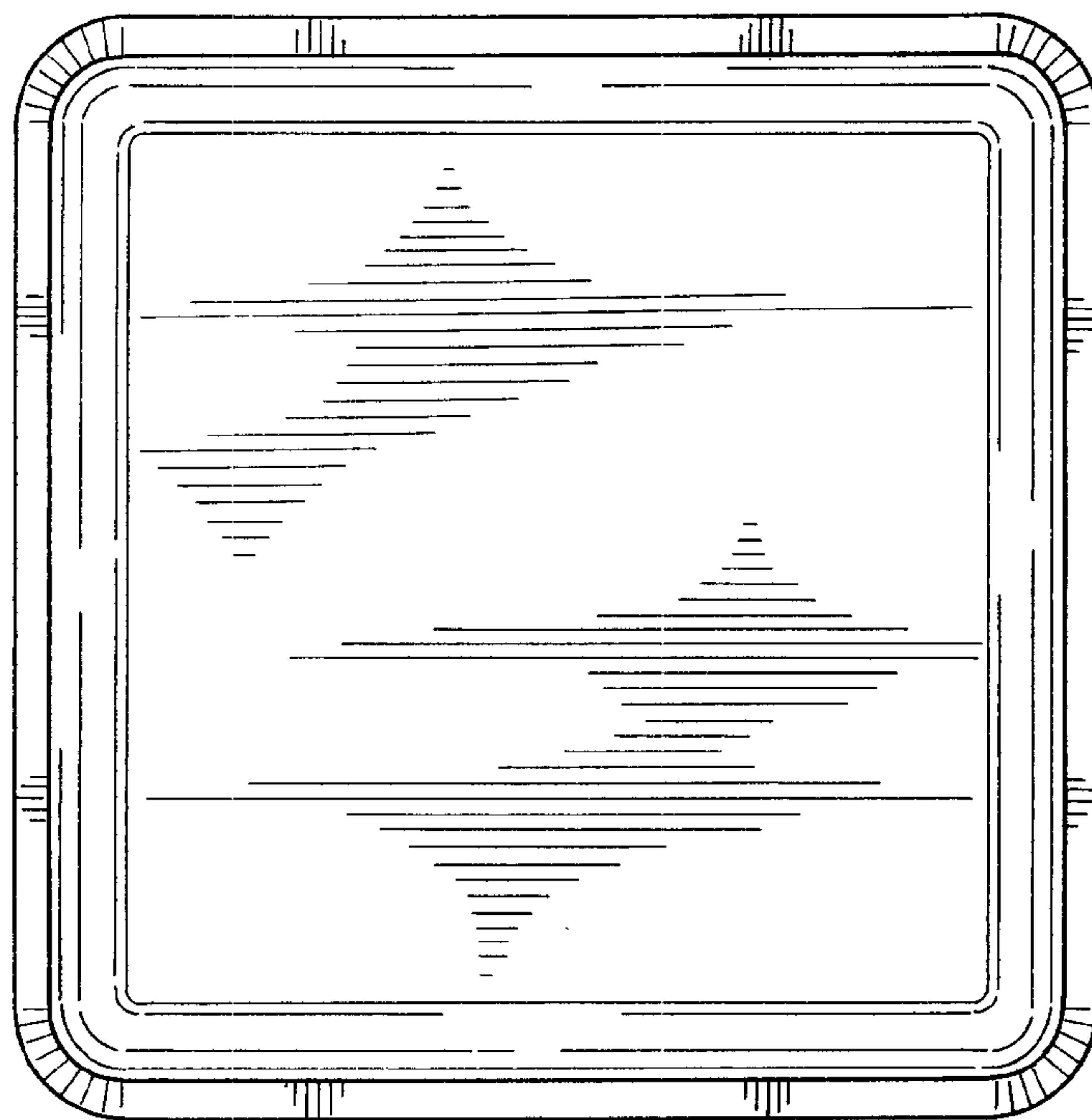

FIG. 7

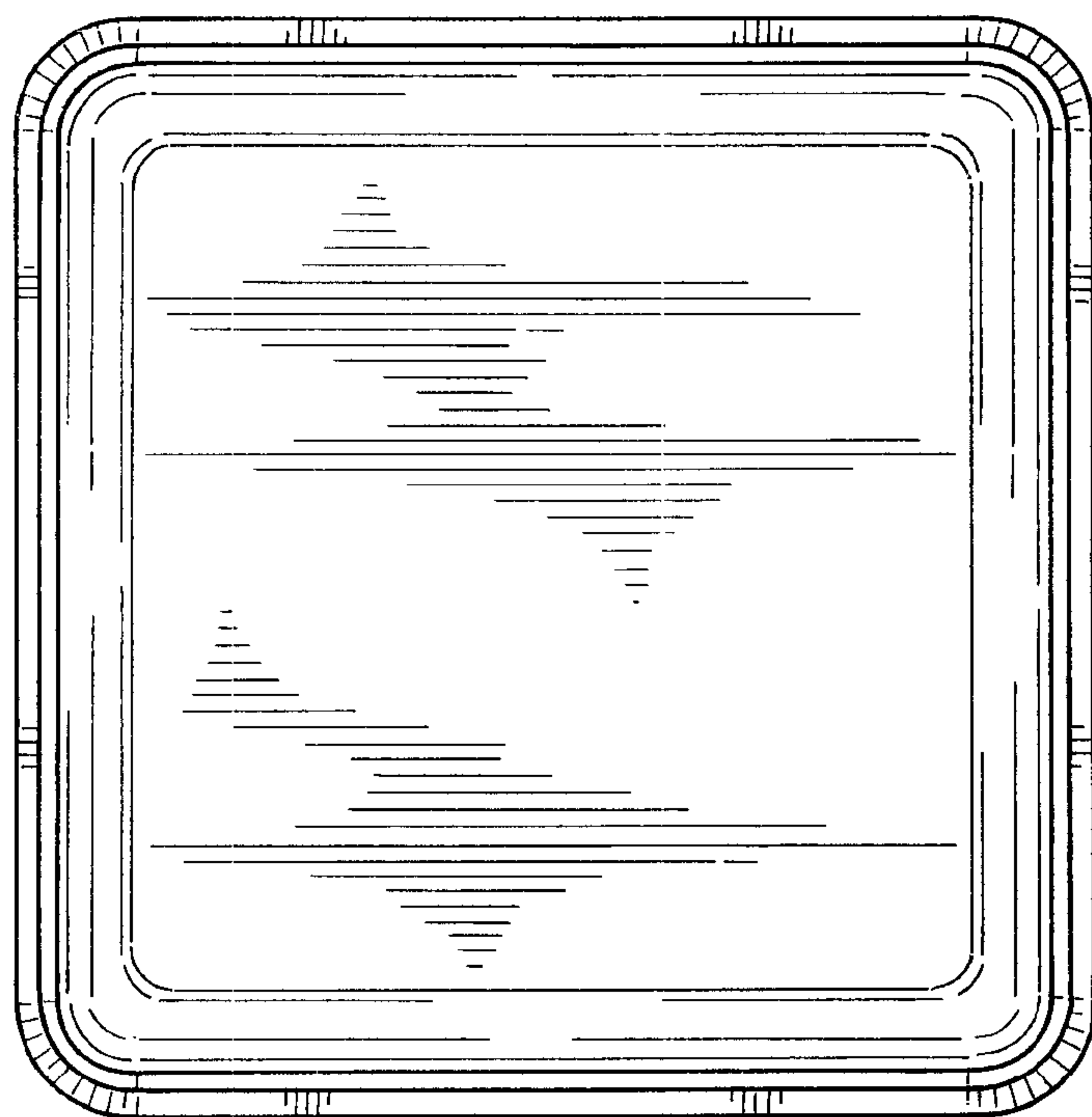

FIG. 8