



US00D646117S

(12) **United States Design Patent**  
**Thelen et al.**

(10) **Patent No.:** **US D646,117 S**

(45) **Date of Patent:** **\*\* Oct. 4, 2011**

(54) **COOKING POT**

(75) Inventors: **Arnold Thelen**, Idar-Oberstein (DE);  
**Ernst Wedekind**, Köln (DE)

(73) Assignee: **Fissler GmbH**, Idar-Oberstein (DE)

(\*\*) Term: **14 Years**

(21) Appl. No.: **29/385,243**

(22) Filed: **Feb. 10, 2011**

(51) **LOC (9) Cl.** ..... **07-02**

(52) **U.S. Cl.** ..... **D7/358; D7/354**

(58) **Field of Classification Search** ..... D7/323,  
D7/329-331, 339, 346-347, 350.1-350.4,  
D7/353-367, 391, 393, 395, 402, 406, 538,  
D7/542, 587; 99/324-325, 331-332, 337-340,  
99/369, 400-418, 422, 425, 444, 483; 126/37 R,  
126/261, 374.1, 378.1; 206/501-505, 507-508;  
219/400, 405, 429-442, 620-624, 725, 730-735;  
220/203.05, 203.07, 203.09, 298, 315-316,  
220/573.1-573.5, 912; 426/438, 441

See application file for complete search history.

(56) **References Cited**

**U.S. PATENT DOCUMENTS**

D156,298 S *	11/1949	Wagner	.....	D7/358
4,257,394 A *	3/1981	Zabel	.....	126/374.1
D263,270 S *	3/1982	Pauty	.....	D7/358
D263,782 S *	4/1982	Jackson et al.	.....	D7/358
D295,817 S *	5/1988	Sebillotte	.....	D7/358
D312,751 S *	12/1990	Moreno	.....	D7/358
5,135,121 A *	8/1992	Javier	.....	220/203.07
D353,969 S *	1/1995	Savinel	.....	D7/358
D365,494 S *	12/1995	Roussard	.....	D7/358
D370,382 S *	6/1996	Combe	.....	D7/360

D384,547 S *	10/1997	Roussard et al.	.....	D7/358
6,067,896 A *	5/2000	Elorza	.....	99/337
D432,349 S *	10/2000	Jo	.....	D7/358
D433,273 S *	11/2000	Roussard	.....	D7/358
D445,631 S *	7/2001	Elorza	.....	D7/358
D453,661 S *	2/2002	Colletti	.....	D7/358
D455,600 S *	4/2002	Barrena	.....	D7/358
D521,312 S *	5/2006	Pukall et al.	.....	D7/360
D524,596 S *	7/2006	Magnouloux	.....	D7/393
D530,145 S *	10/2006	Bergara	.....	D7/358
D530,974 S *	10/2006	Bergara	.....	D7/358
D570,153 S *	6/2008	Bergara	.....	D7/358
D572,521 S *	7/2008	Bergara	.....	D7/358
D588,397 S *	3/2009	Naef et al.	.....	D7/354
D618,041 S *	6/2010	Thelen et al.	.....	D7/358
D618,042 S *	6/2010	Thelen et al.	.....	D7/358

\* cited by examiner

*Primary Examiner* — Ricky Pham

(74) *Attorney, Agent, or Firm* — Foley & Lardner LLP

(57) **CLAIM**

We claim the ornamental design for a cooking pot, as shown and described.

**DESCRIPTION**

FIG. 1 is a perspective view of a cooking pot according to our new design;  
FIG. 2 is a right side view of the cooking pot shown in FIG. 1;  
FIG. 3 is a left side view of the cooking pot shown in FIG. 1;  
FIG. 4 is a front view of the cooking pot shown in FIG. 1;  
FIG. 5 is a rear view of the cooking pot shown in FIG. 1;  
FIG. 6 is a top view of the cooking pot shown in FIG. 1; and,  
FIG. 7 is a bottom view of the cooking pot shown in FIG. 1.  
Broken lines in the drawings are for illustrative purposes only and form no part of the claimed design.

**1 Claim, 4 Drawing Sheets**

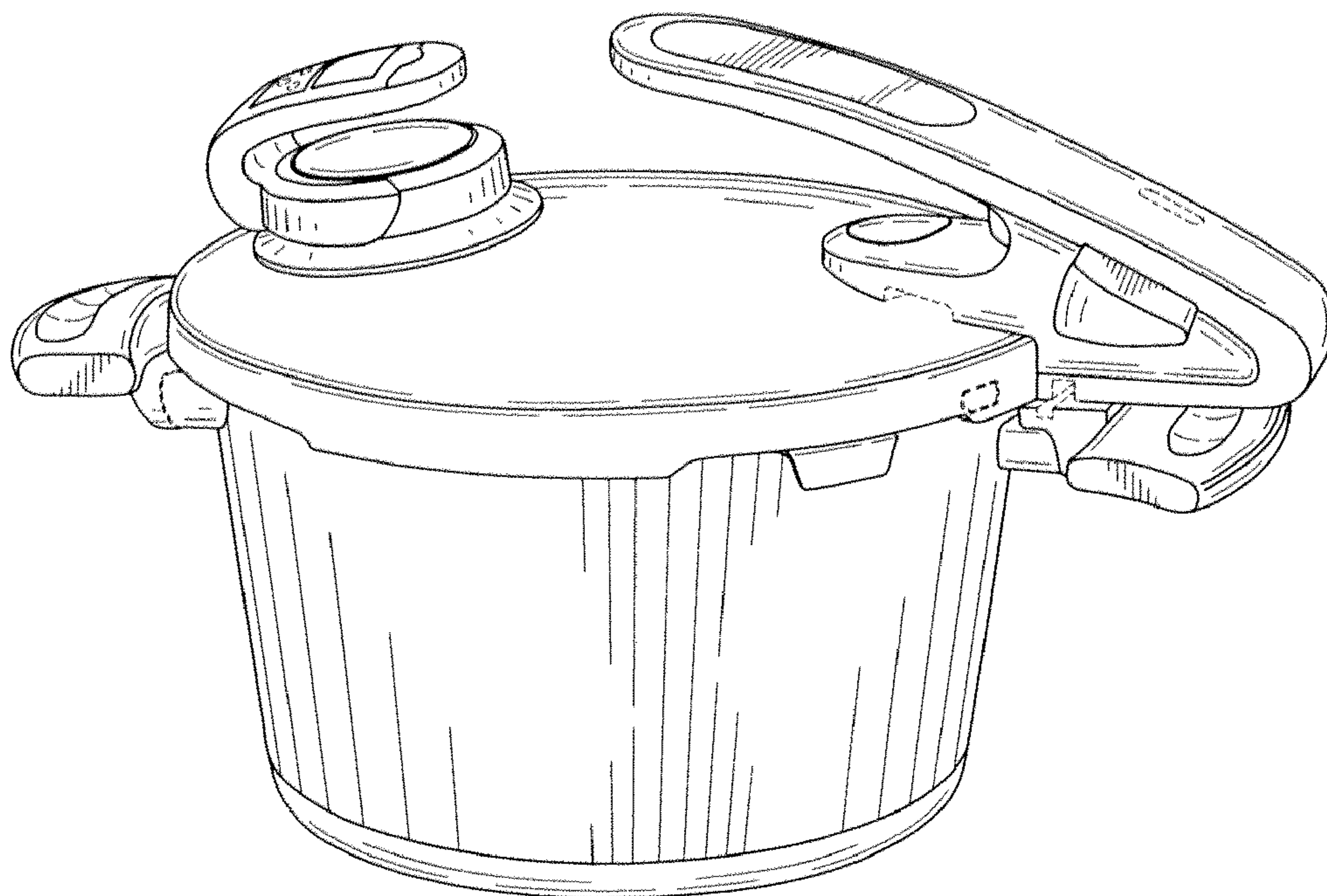

Fig. 1

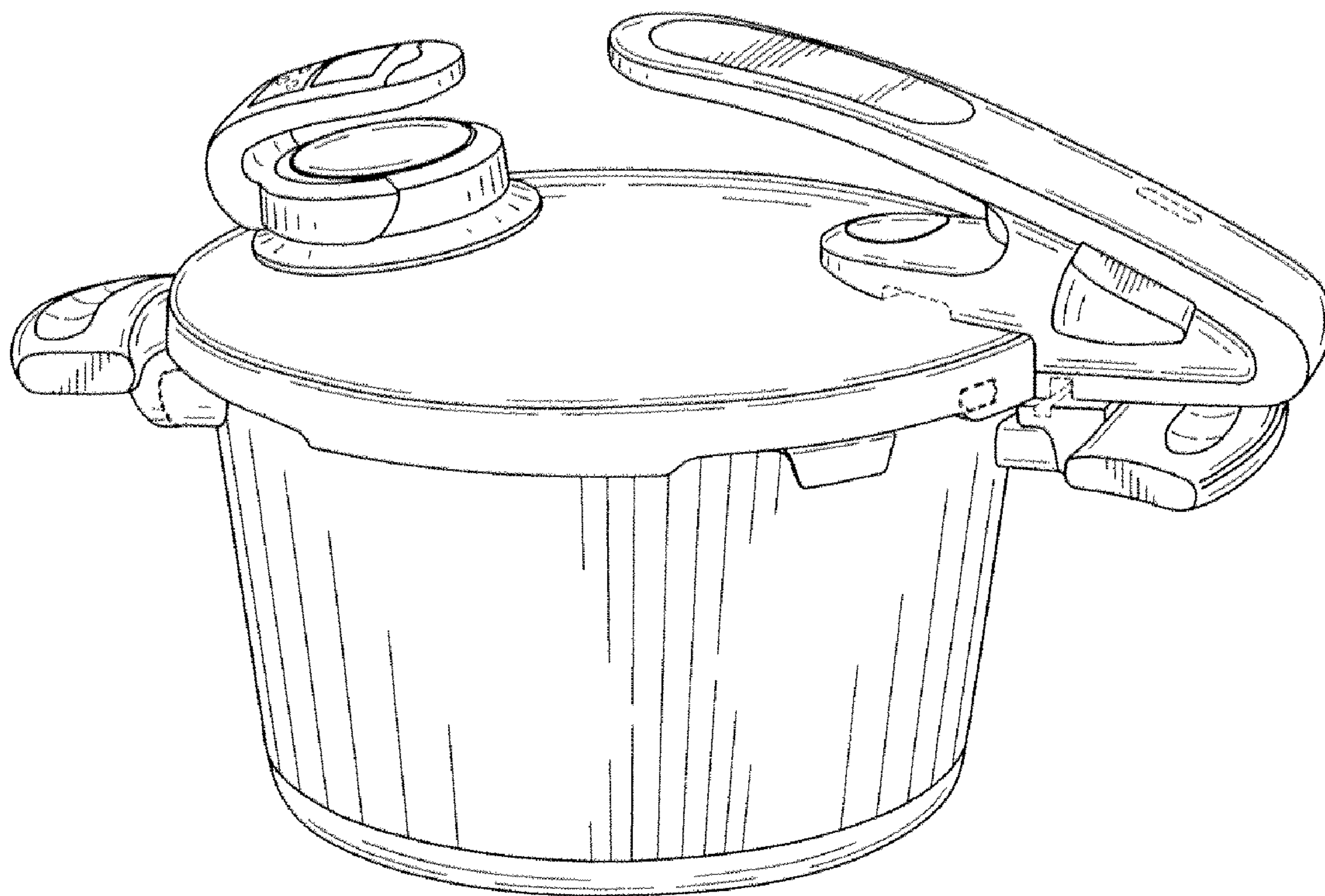



Fig. 2

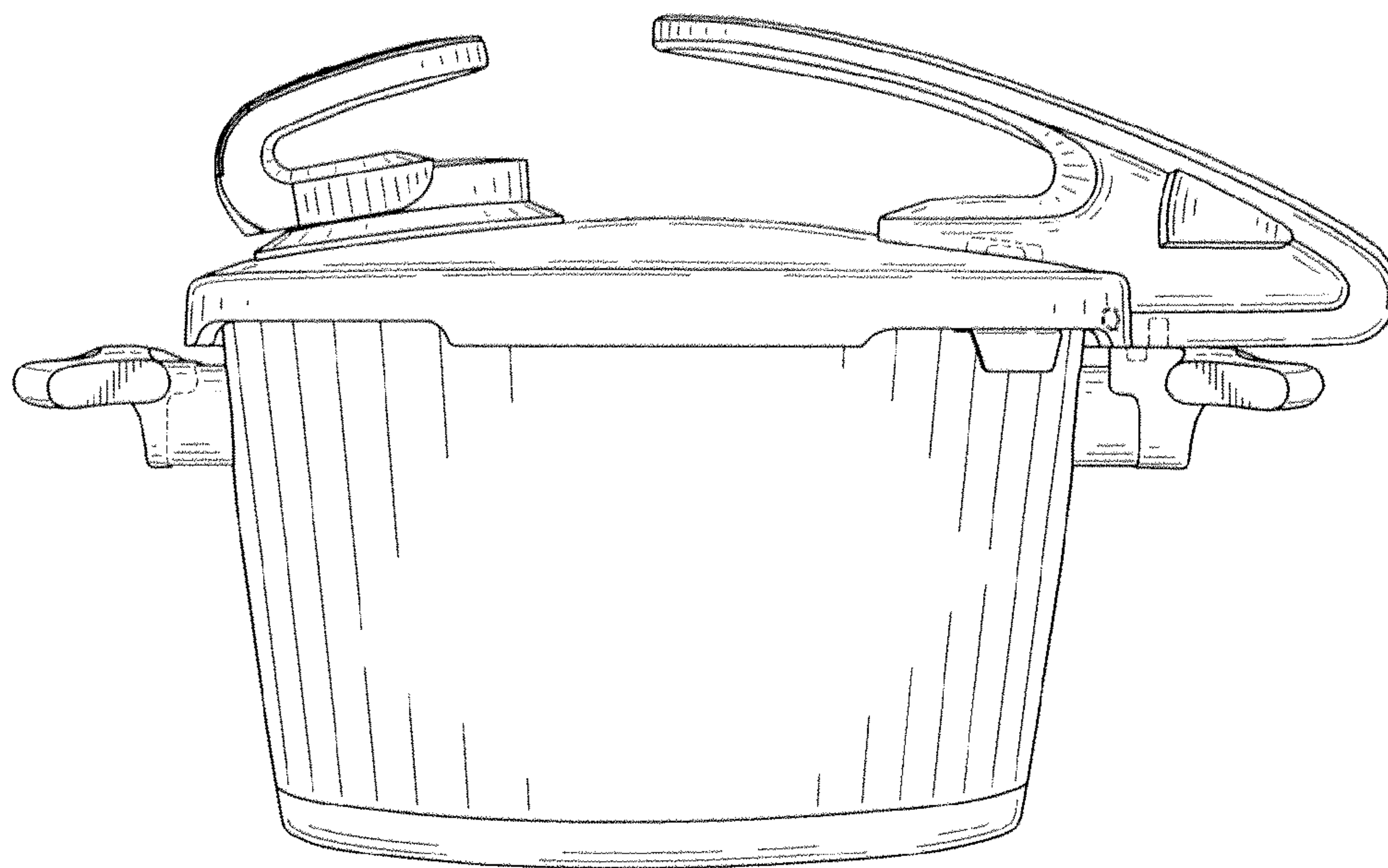

Fig. 3

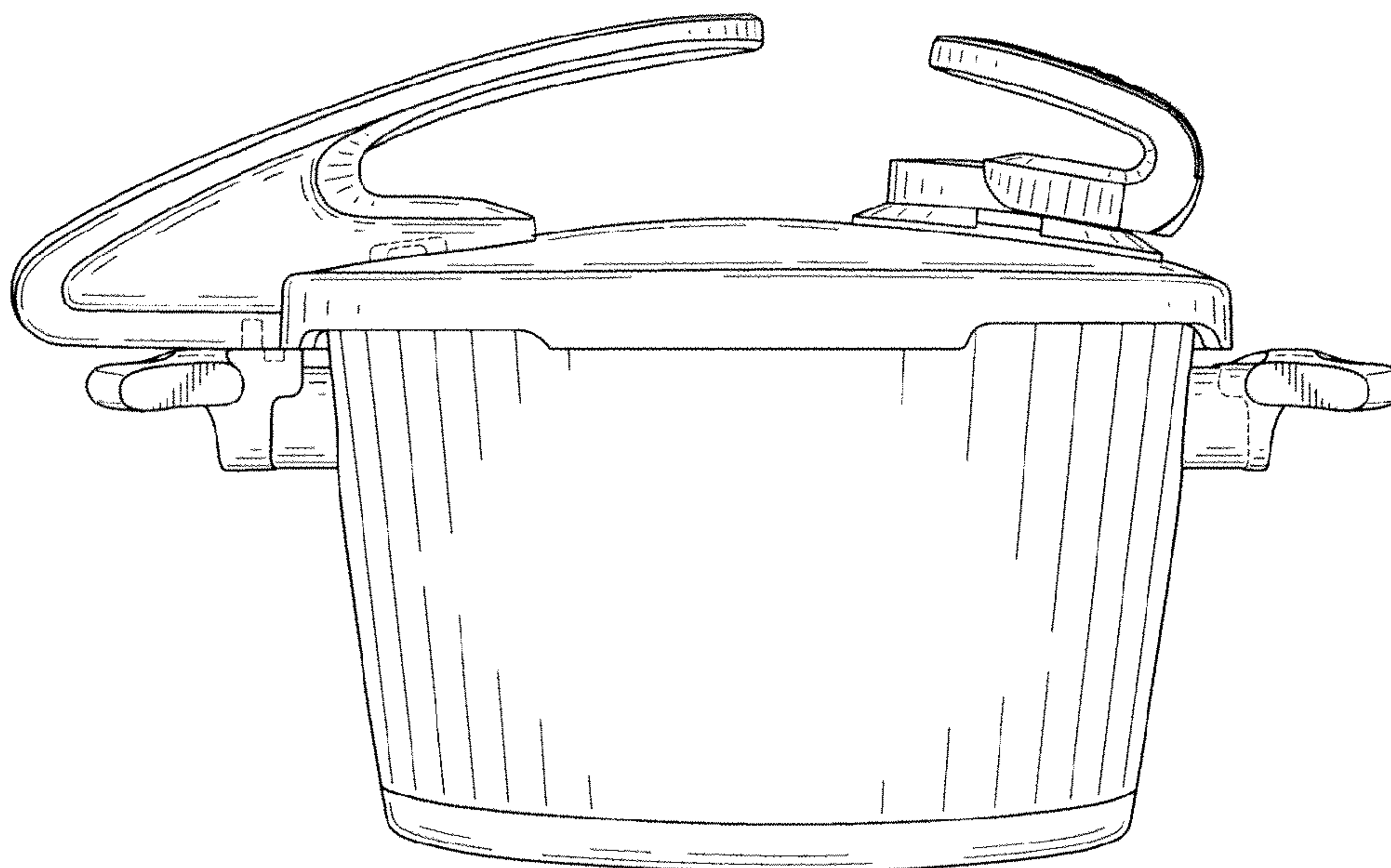

Fig. 4

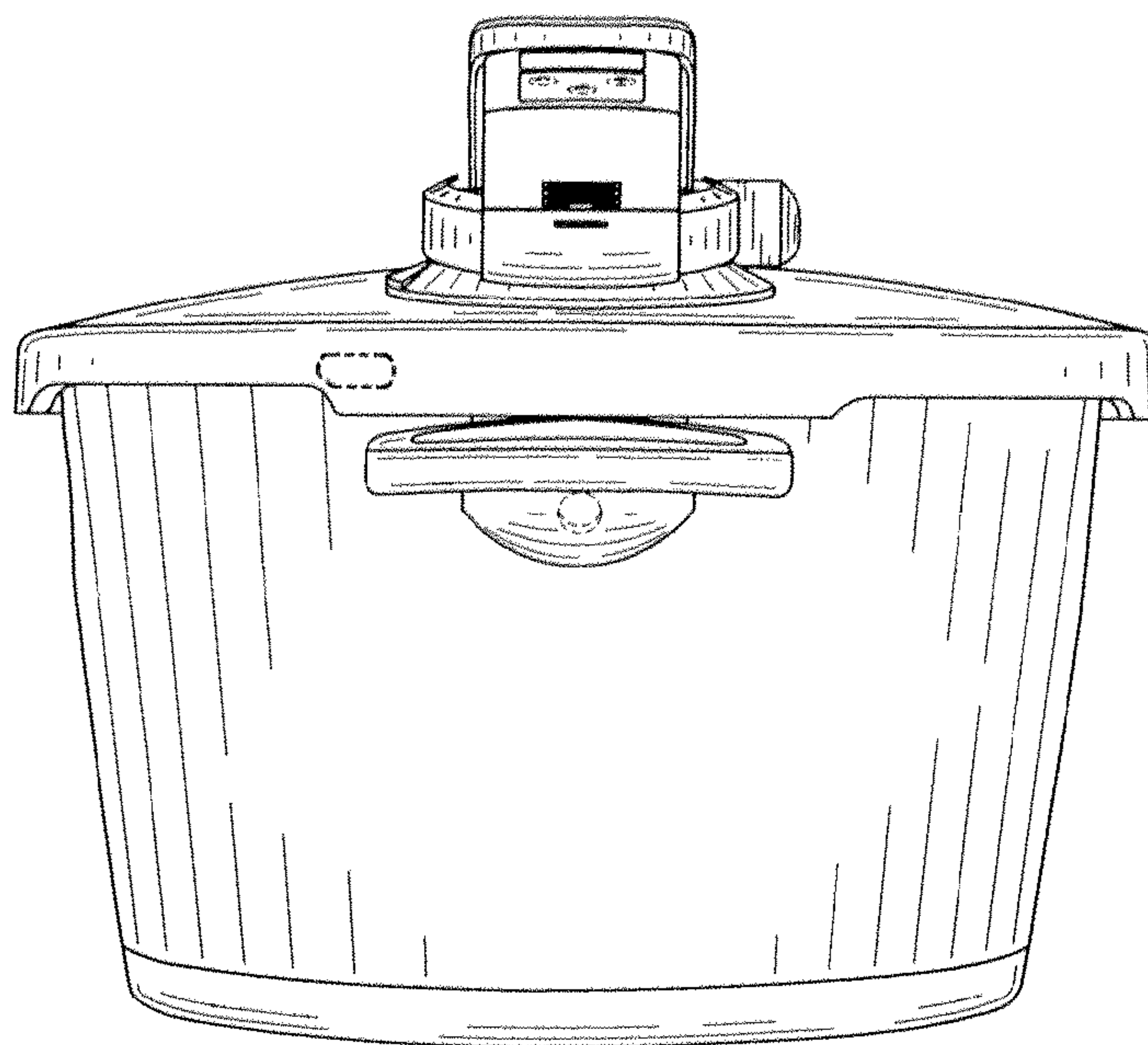

Fig. 5

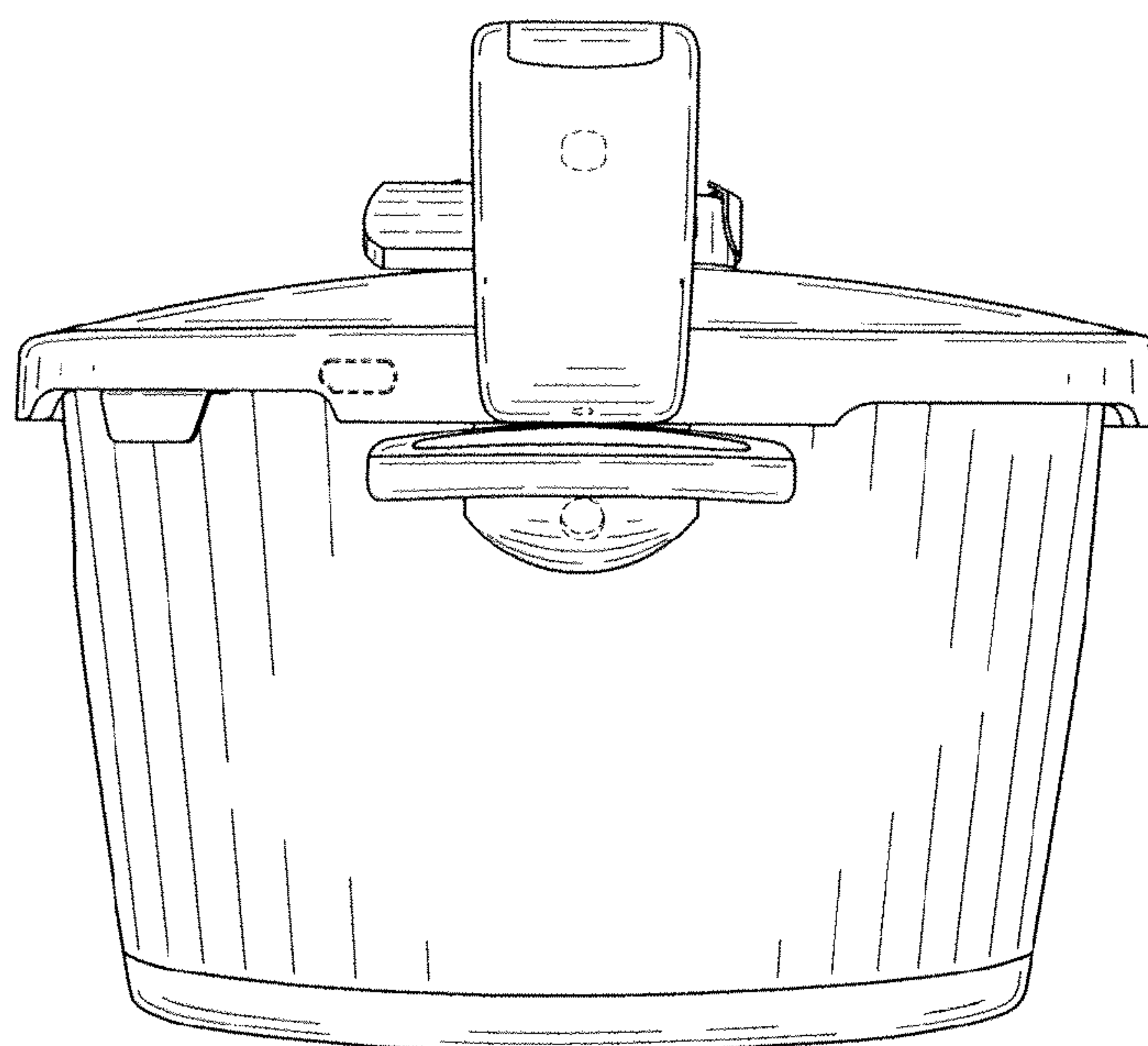

Fig. 6

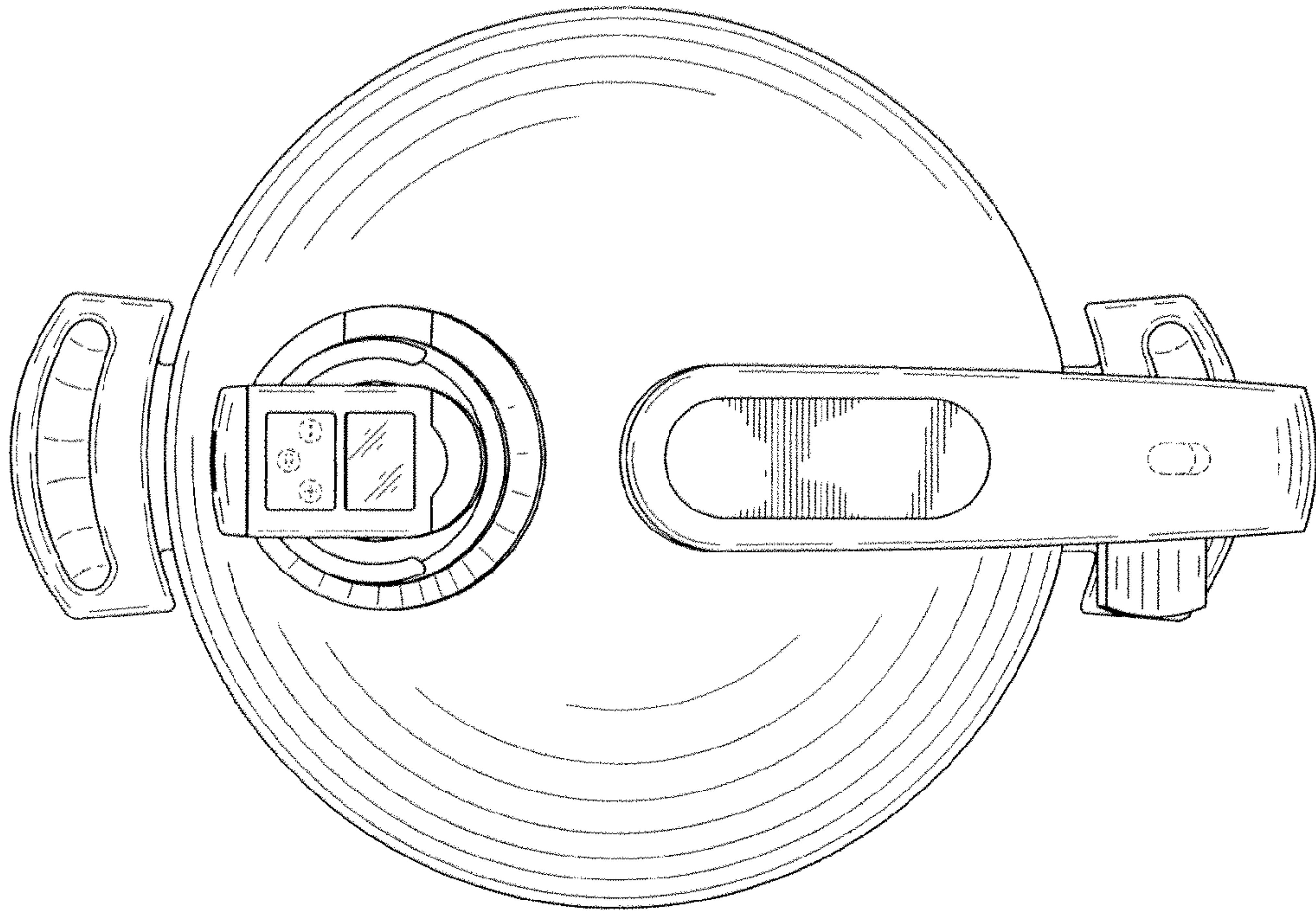

Fig. 7

