



US00D646053S

(12) **United States Design Patent**
Traiger

(10) **Patent No.:** **US D646,053 S**

(45) **Date of Patent:** **** Oct. 4, 2011**

(54) **CINCH BAG**

(76) Inventor: **Alan L. Traiger**, Livingston, NJ (US)

(**) Term: **14 Years**

(21) Appl. No.: **29/379,730**

(22) Filed: **Nov. 23, 2010**

Related U.S. Application Data

(62) Division of application No. 29/345,805, filed on Oct. 22, 2009, now Pat. No. Des. 629,605.

(51) **LOC (9) Cl.** **03-01**

(52) **U.S. Cl.** **D3/234; D3/238; D3/244**

(58) **Field of Classification Search** D3/232–234,
D3/238, 244; 150/100, 103–110, 113–114,
150/118–119

See application file for complete search history.

(56) **References Cited**

U.S. PATENT DOCUMENTS

D231,590 S	5/1974	McKinney	
D289,226 S	4/1987	Zisholtz	
D335,956 S	6/1993	Lucas	
D339,915 S	10/1993	Lucas	
D362,960 S	10/1995	Stein	
D365,443 S	12/1995	Wu	
D394,348 S	5/1998	Aliff	
D406,461 S	3/1999	Aliff	
5,988,879 A	11/1999	Bredderman et al.	
D448,927 S	10/2001	Vazquez	
D468,906 S	1/2003	Rugg	
D469,608 S	2/2003	Nevins	
D471,708 S	3/2003	Rugg	
D528,787 S *	9/2006	Prentice	D3/238
D534,347 S	1/2007	Prentice	
D539,034 S	3/2007	Friedman	
D547,948 S	8/2007	Friedman	
D555,431 S	11/2007	Gostt et al.	
D555,981 S	11/2007	Gostt et al.	
D566,386 S *	4/2008	Linsenman	D3/238
D571,101 S *	6/2008	Linsenman	D3/238

* cited by examiner

Primary Examiner — Holly Baynham

(74) *Attorney, Agent, or Firm* — Weitzman Law Offices, LLC

(57) **CLAIM**

The ornamental design for a cinch bag, as shown and described.

DESCRIPTION

FIG. 1 is a front perspective view of a second embodiment of the new ornamental cinch bag shown in an unopened configuration;

FIG. 2 is a front view of the second embodiment thereof;

FIG. 3 is a rear view of the second embodiment thereof;

FIG. 4 is a right side view of the second embodiment thereof;

FIG. 5 is a left side view of the second embodiment thereof;

FIG. 6 is a bottom view of the second embodiment thereof;

FIG. 7 is a top view of the second embodiment thereof;

FIG. 8 is a front perspective view of the second embodiment thereof shown in an opened configuration;

FIG. 9 is a front perspective view of a third embodiment of the new ornamental cinch bag shown in an unopened configuration;

FIG. 10 is a front view of the third embodiment thereof;

FIG. 11 is a rear view of the third embodiment thereof;

FIG. 12 is a right side view of the third embodiment thereof;

FIG. 13 is a left side view of the third embodiment thereof;

FIG. 14 is a bottom view of the third embodiment thereof;

FIG. 15 is a top view of the third embodiment thereof;

FIG. 16 is a front perspective view of the third embodiment thereof shown in an opened configuration;

FIG. 17 is a front perspective view of a fourth embodiment of the new ornamental cinch bag shown in an unopened configuration;

FIG. 18 is a front view of the fourth embodiment thereof;

FIG. 19 is a rear view of the fourth embodiment thereof;

FIG. 20 is a right side view of the fourth embodiment thereof;

FIG. 21 is a left side view of the fourth embodiment thereof;

FIG. 22 is a bottom view of the fourth embodiment thereof;

FIG. 23 is a top view of the fourth embodiment thereof;

FIG. 24 is a front perspective view of the fourth embodiment thereof shown in an opened configuration;

FIG. 25 is a front perspective view of a fifth embodiment of the new ornamental cinch bag shown in an unopened configuration;

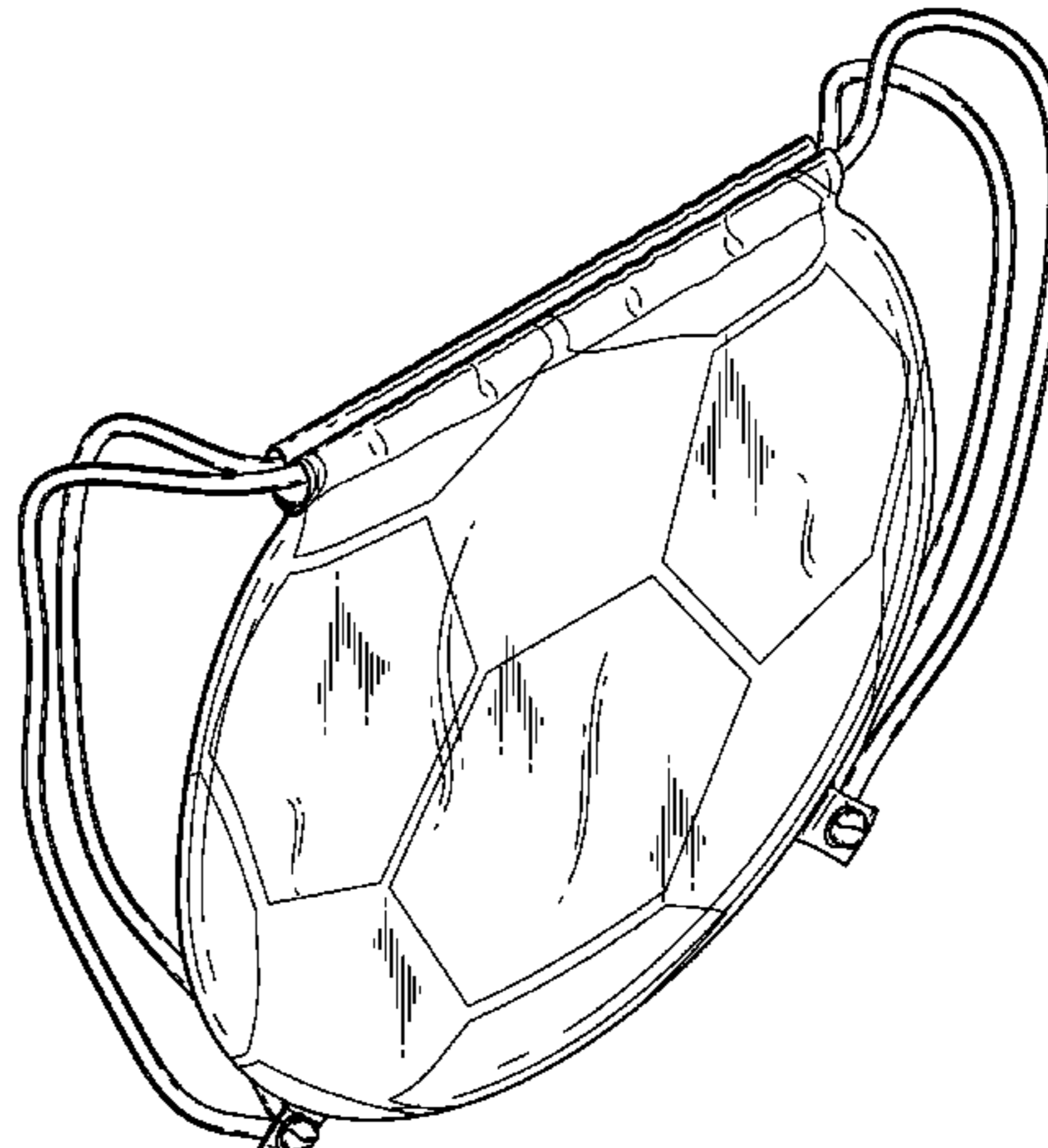
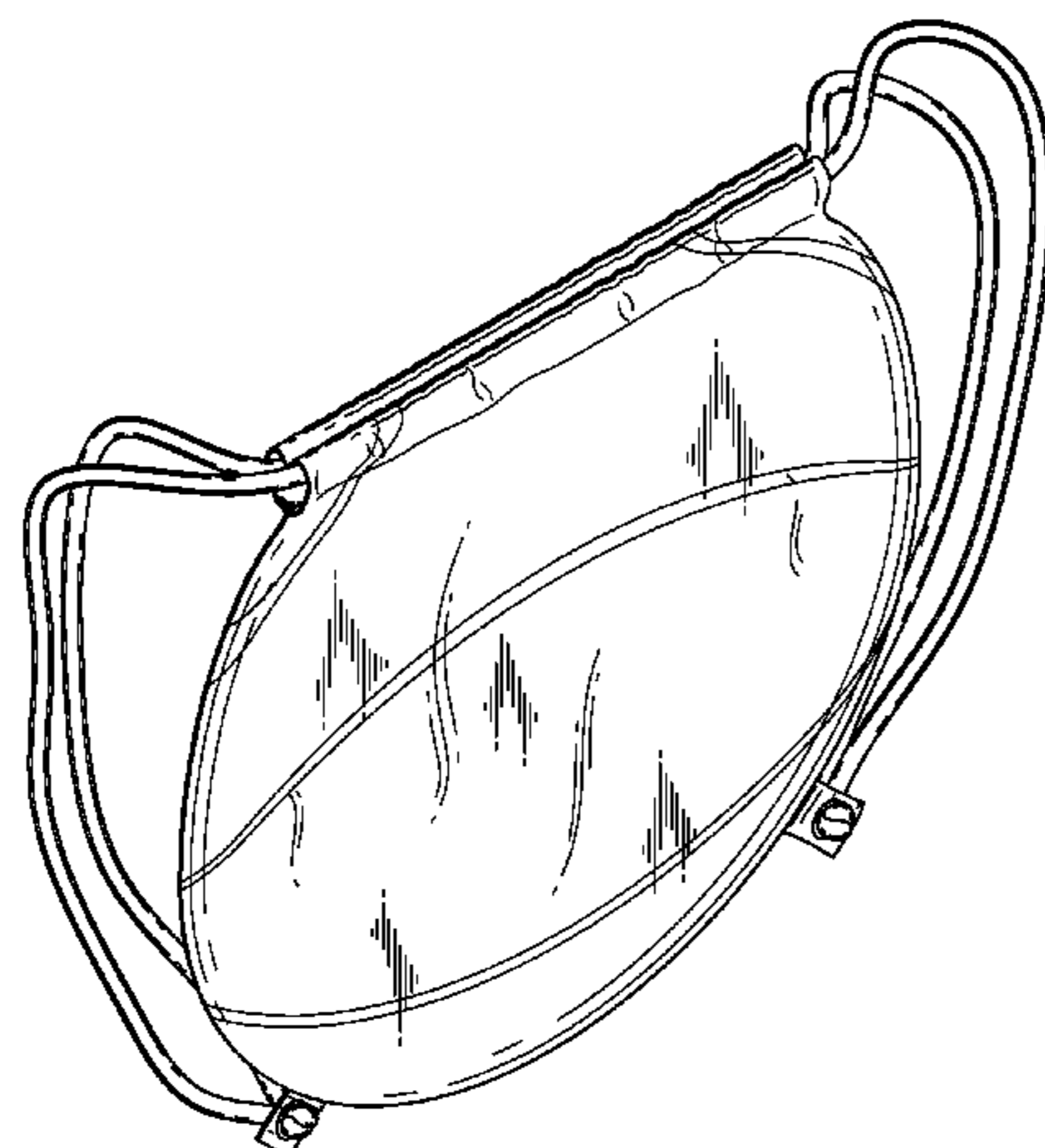

FIG. 26 is a front view of the fifth embodiment thereof;
FIG. 27 is a rear view of the fifth embodiment thereof;
FIG. 28 is a right side view of the fifth embodiment thereof;
FIG. 29 is a left side view of the fifth embodiment thereof;
FIG. 30 is a bottom view of the fifth embodiment thereof;
FIG. 31 is a top view of the fifth embodiment thereof;
FIG. 32 is a front perspective view of the fifth embodiment thereof shown in an opened configuration;
FIG. 33 is a front perspective view of a sixth embodiment of the new ornamental cinch bag shown in an unopened configuration;
FIG. 34 is a front view of the sixth embodiment thereof;
FIG. 35 is a rear view of the sixth embodiment thereof;
FIG. 36 is a right side view of the sixth embodiment thereof;
FIG. 37 is a left side view of the sixth embodiment thereof;
FIG. 38 is a bottom view of the first embodiment thereof;
FIG. 39 is a top view of the sixth embodiment thereof;

FIG. 40 is a front perspective view of the sixth embodiment thereof shown in an opened configuration;
FIG. 41 is a front perspective view of a seventh embodiment of the new ornamental cinch bag shown in an unopened configuration;
FIG. 42 is a front view of the seventh embodiment thereof;
FIG. 43 is a rear view of the seventh embodiment thereof;
FIG. 44 is a right side view of the seventh embodiment thereof;
FIG. 45 is a left side view of the seventh embodiment thereof;
FIG. 46 is a bottom view of the seventh embodiment thereof;
FIG. 47 is a top view of the seventh embodiment thereof; and,
FIG. 48 is a front perspective view of the seventh embodiment thereof shown in an opened configuration.
The broken lines shown on the drawings are include for the purpose of illustration and form no part of the claimed design.

1 Claim, 36 Drawing Sheets

FIG. 1

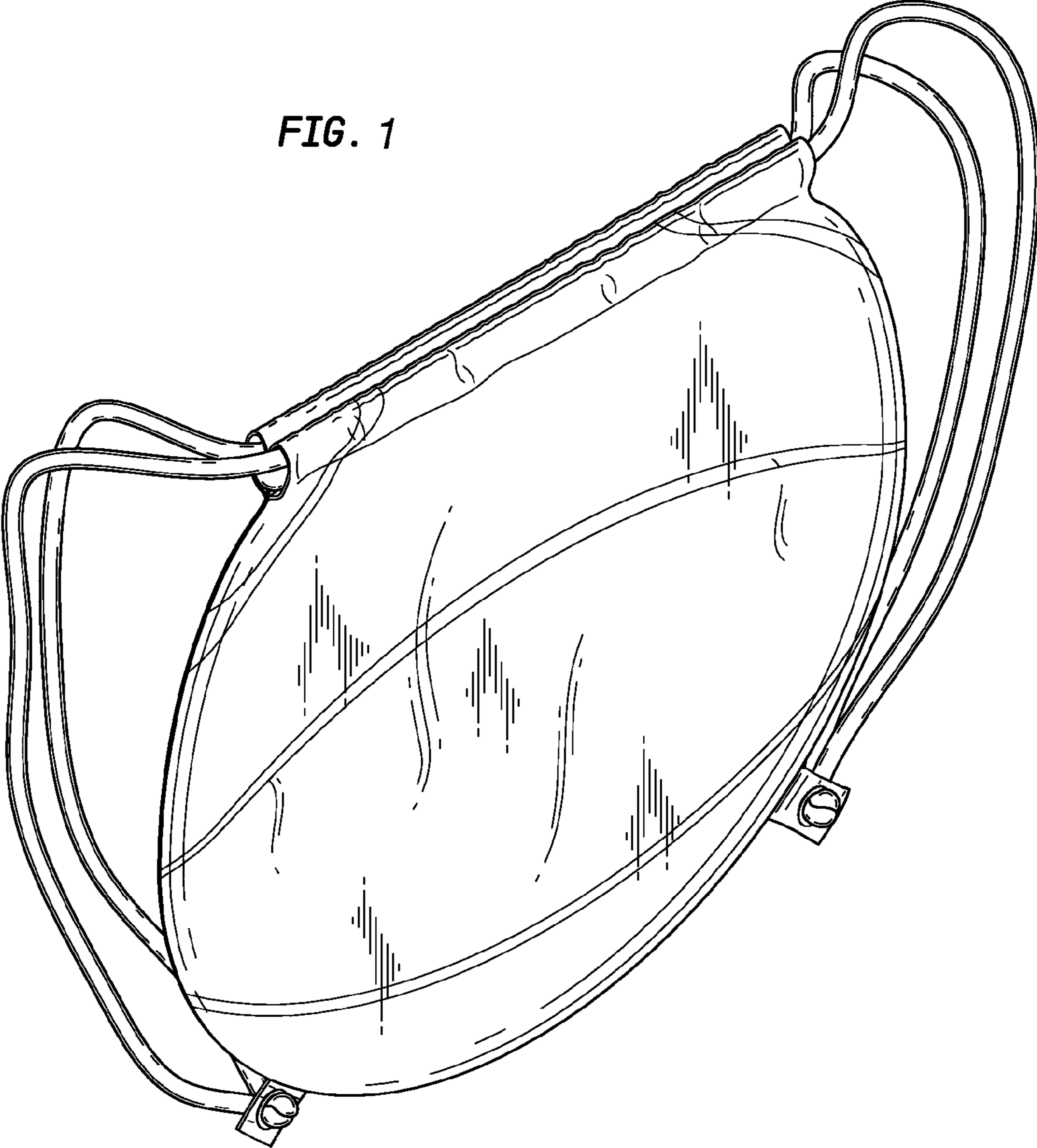

FIG. 2

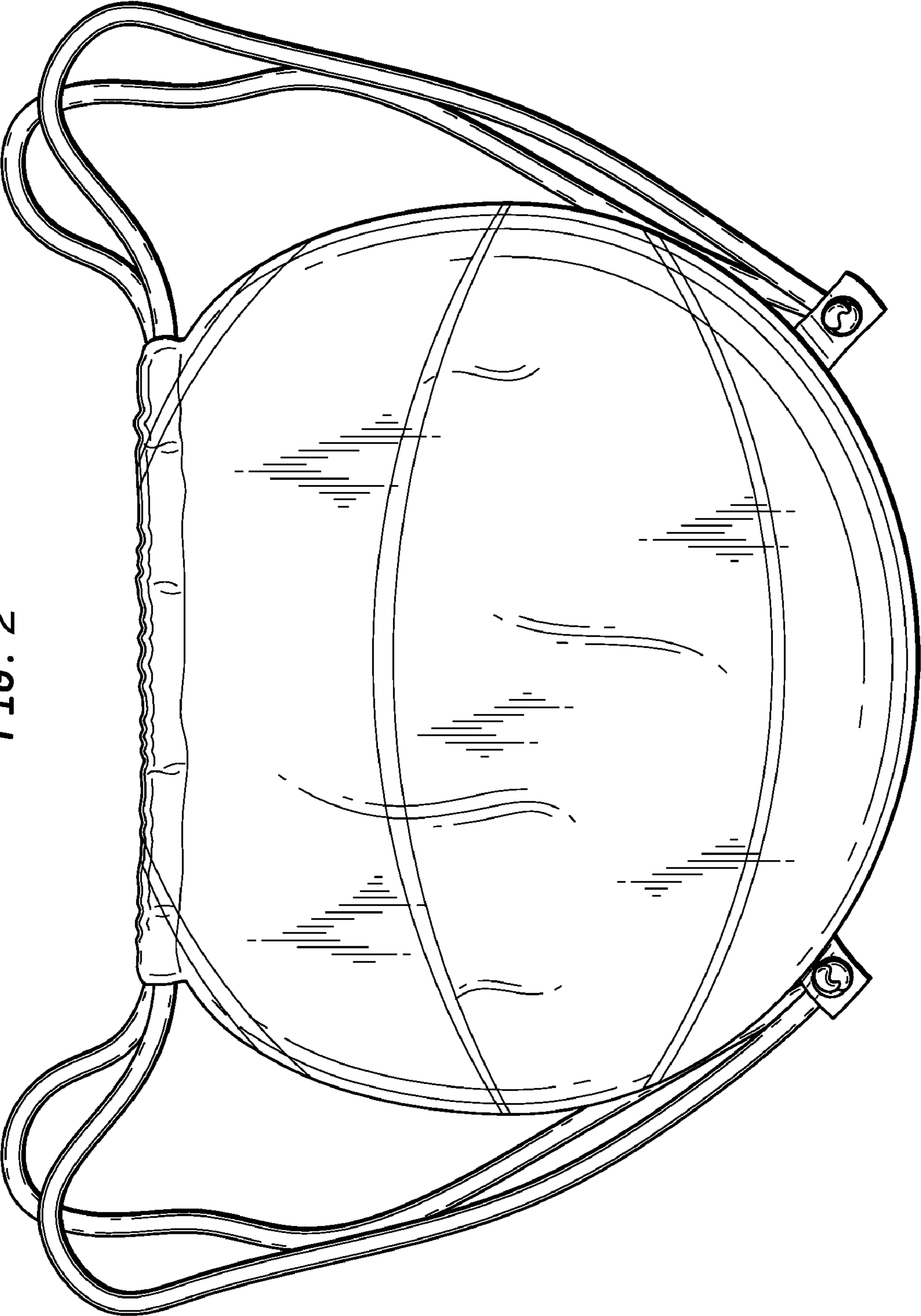

FIG. 3

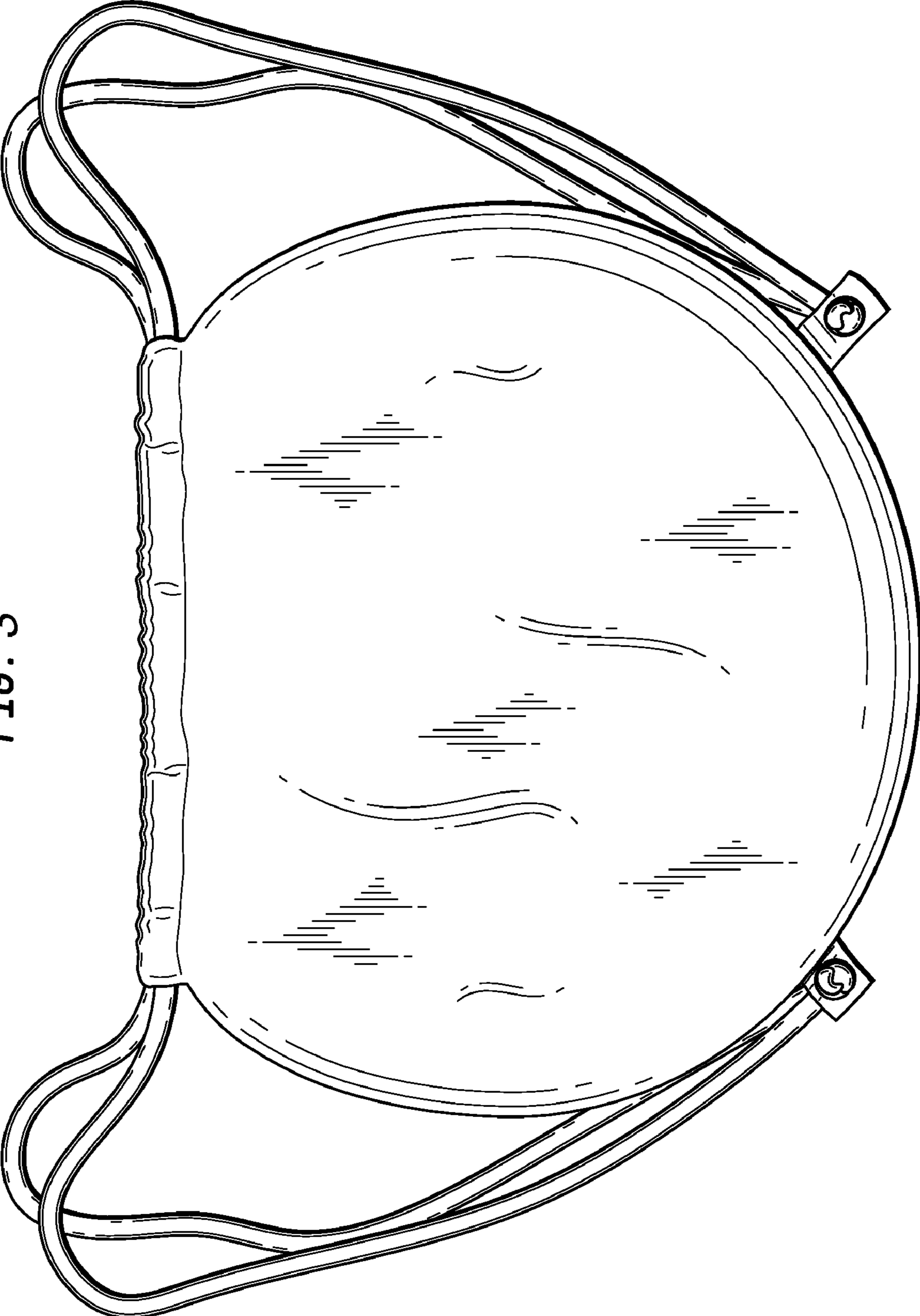

FIG. 4

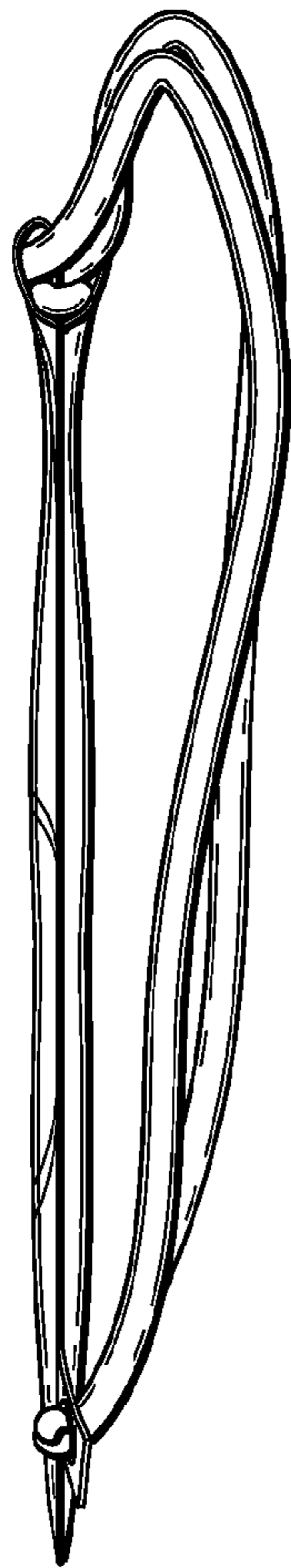

FIG. 5



FIG. 6

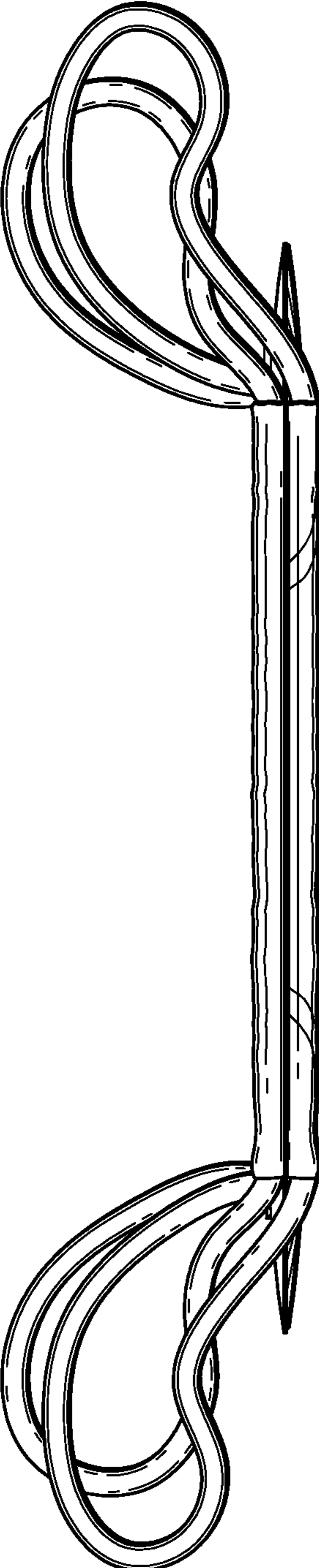

FIG. 7

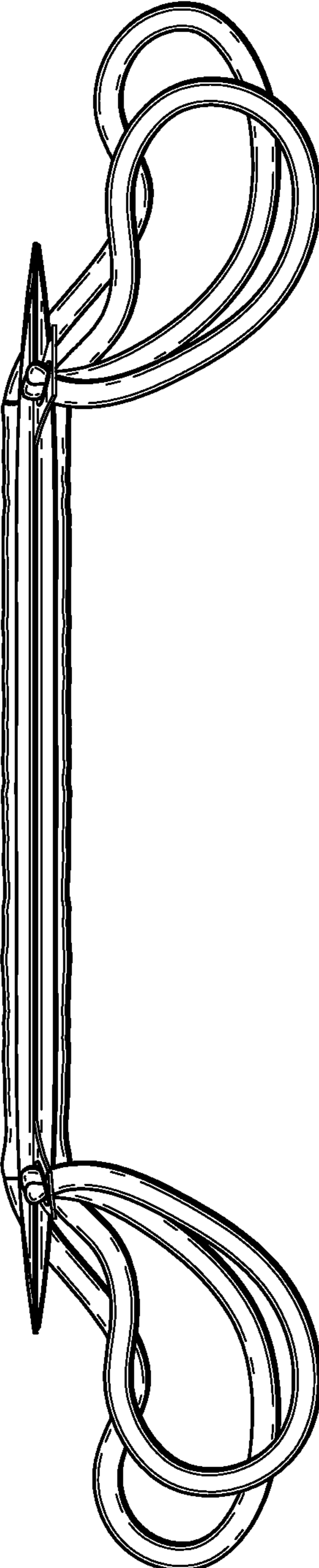

FIG. 8

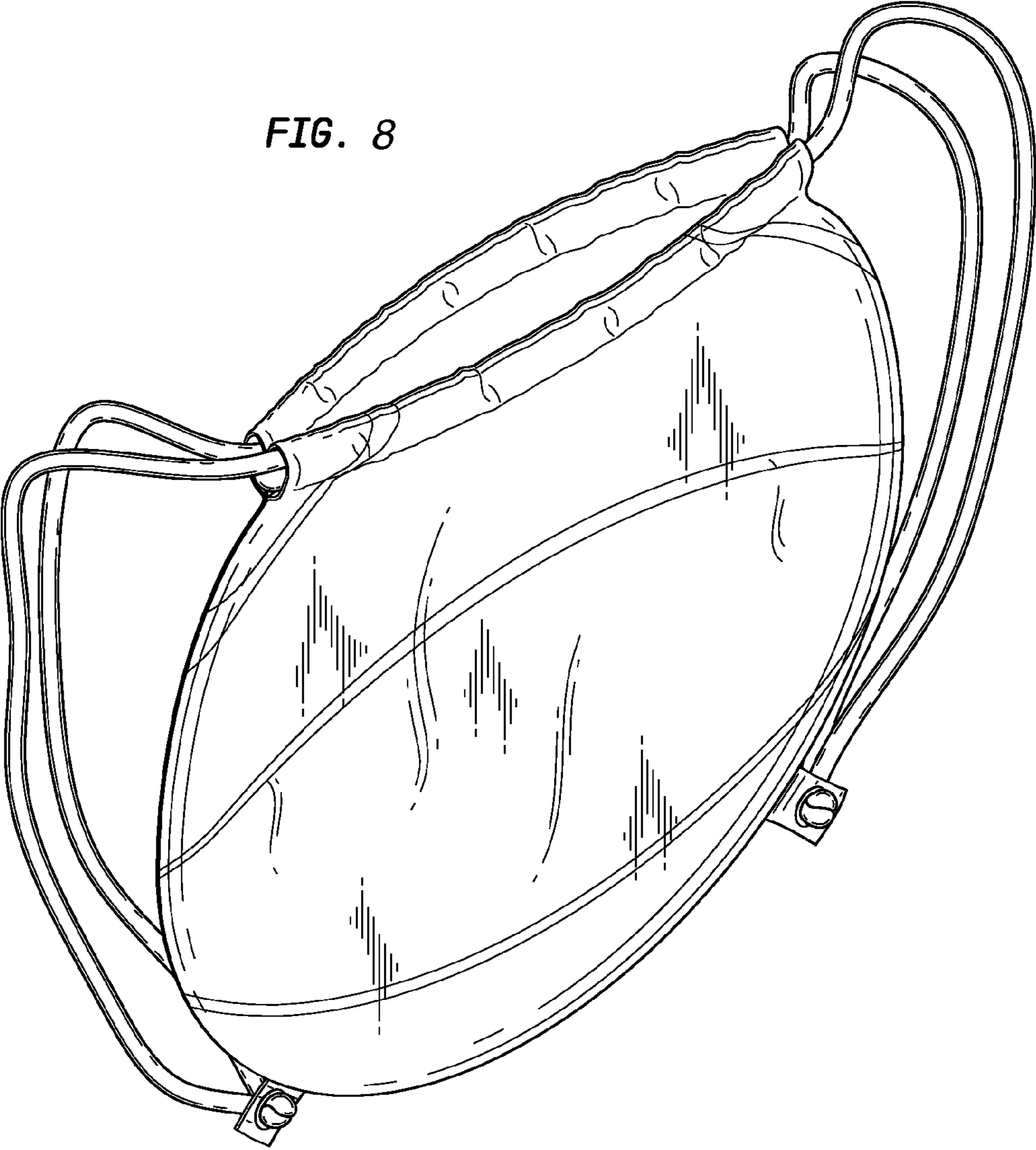

FIG. 9

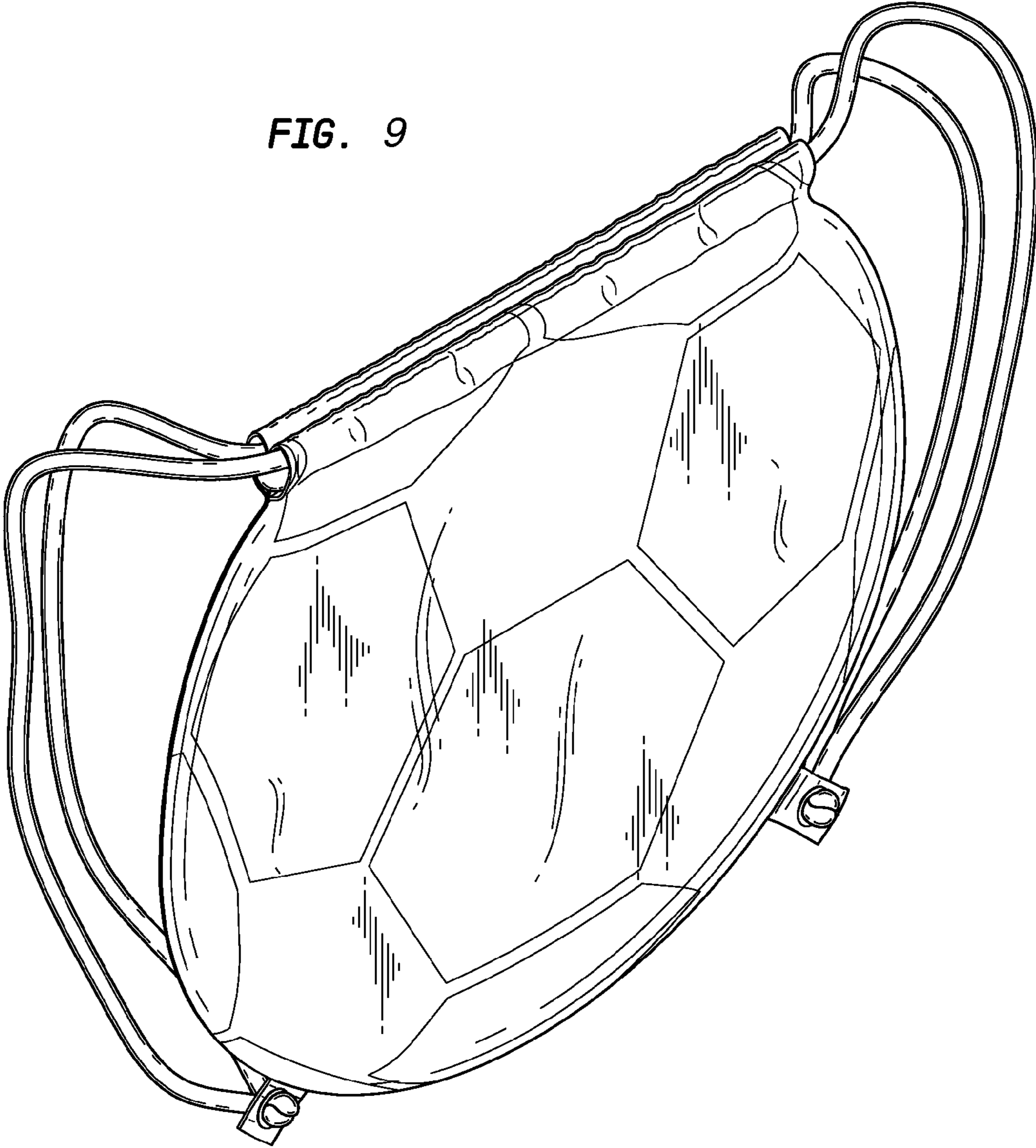

FIG. 10

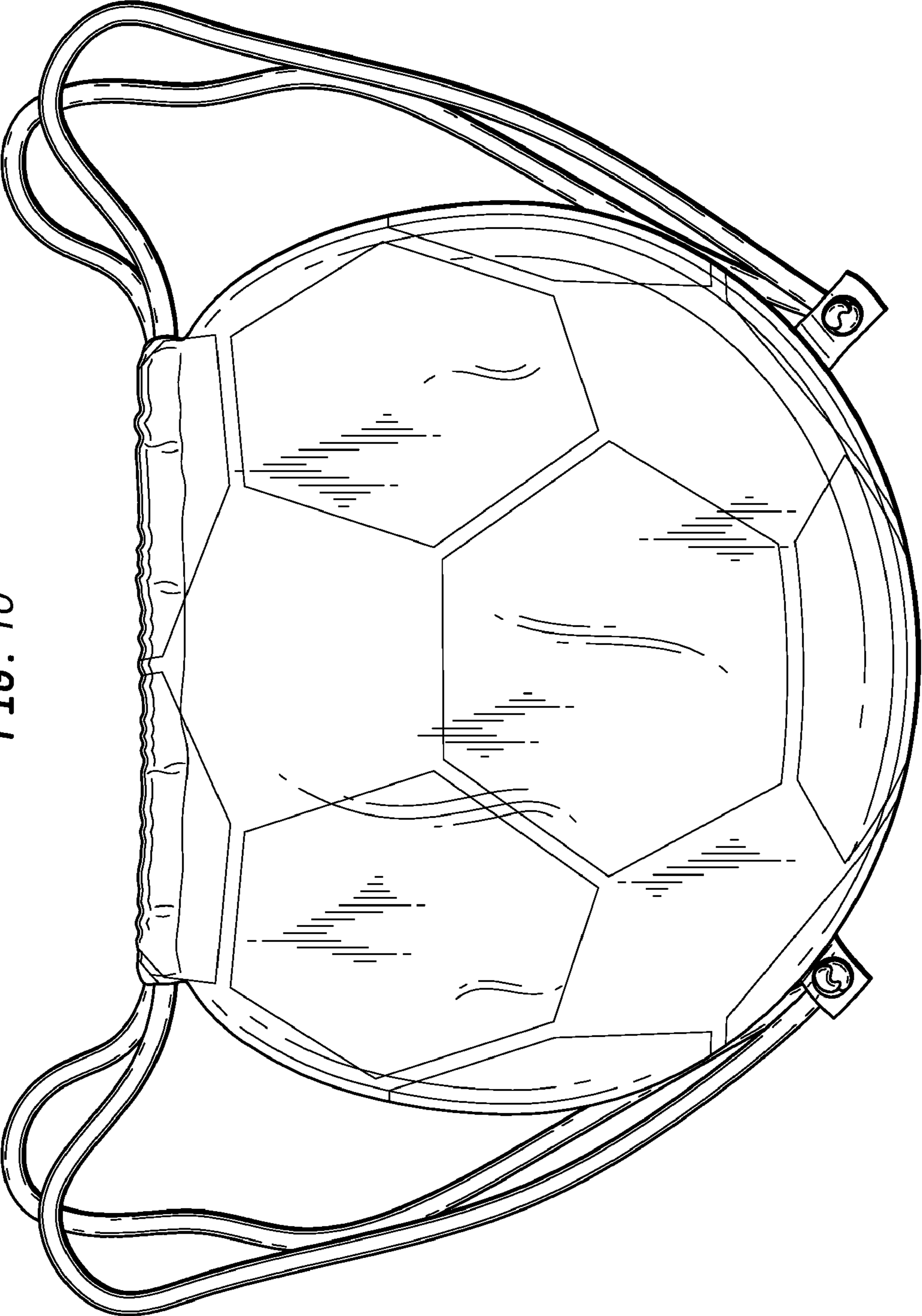

FIG. 11

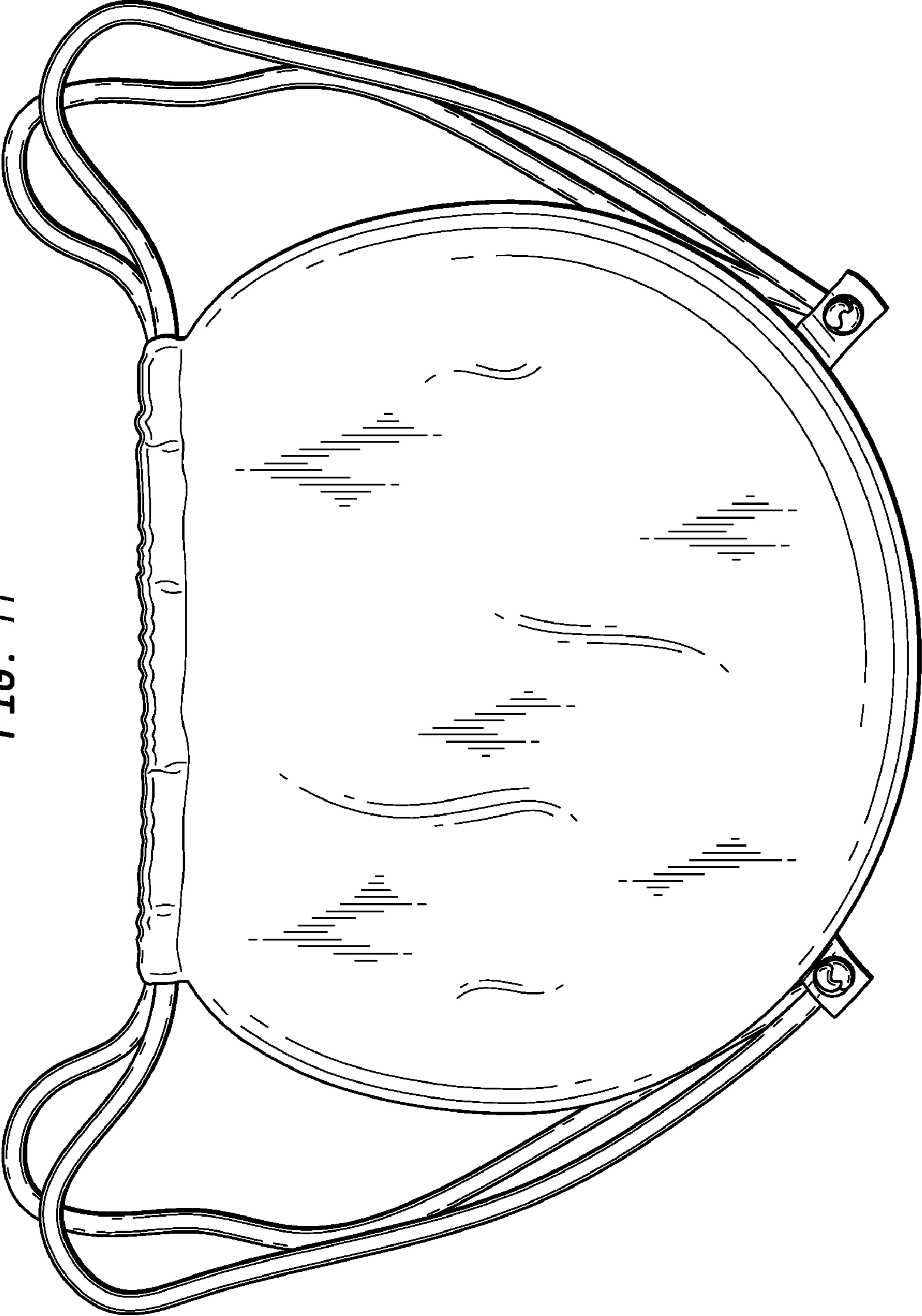

FIG. 12

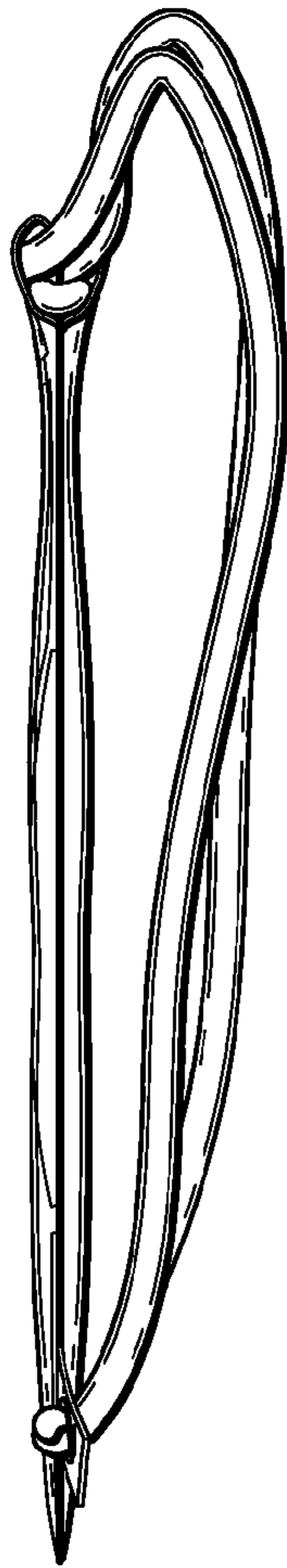

FIG. 13

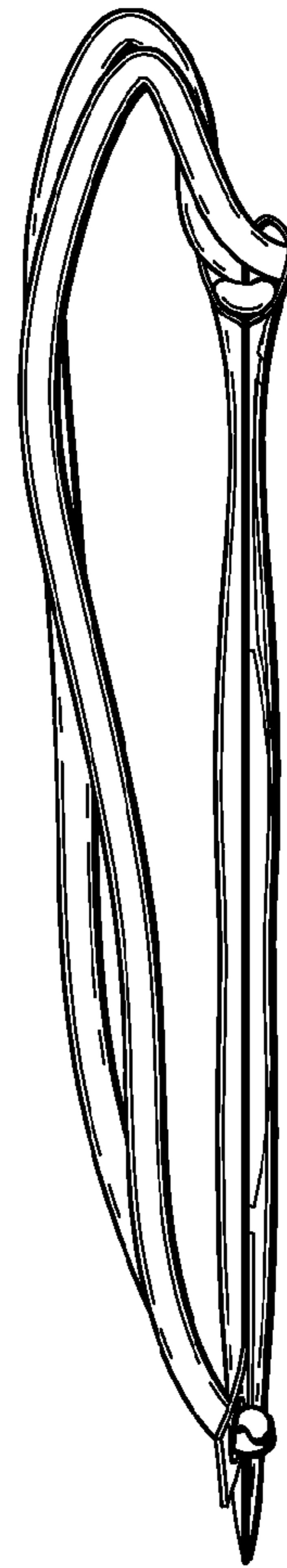

FIG. 14



FIG. 15

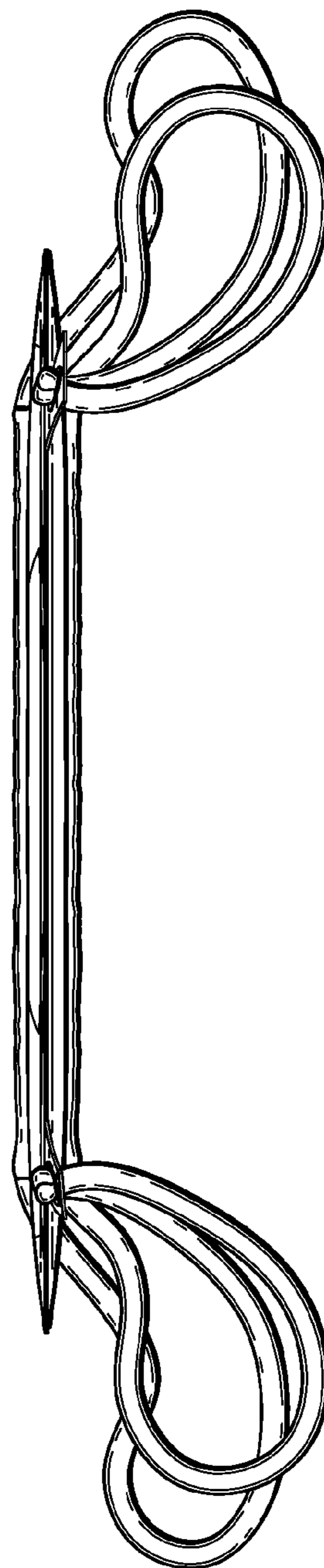

FIG. 16

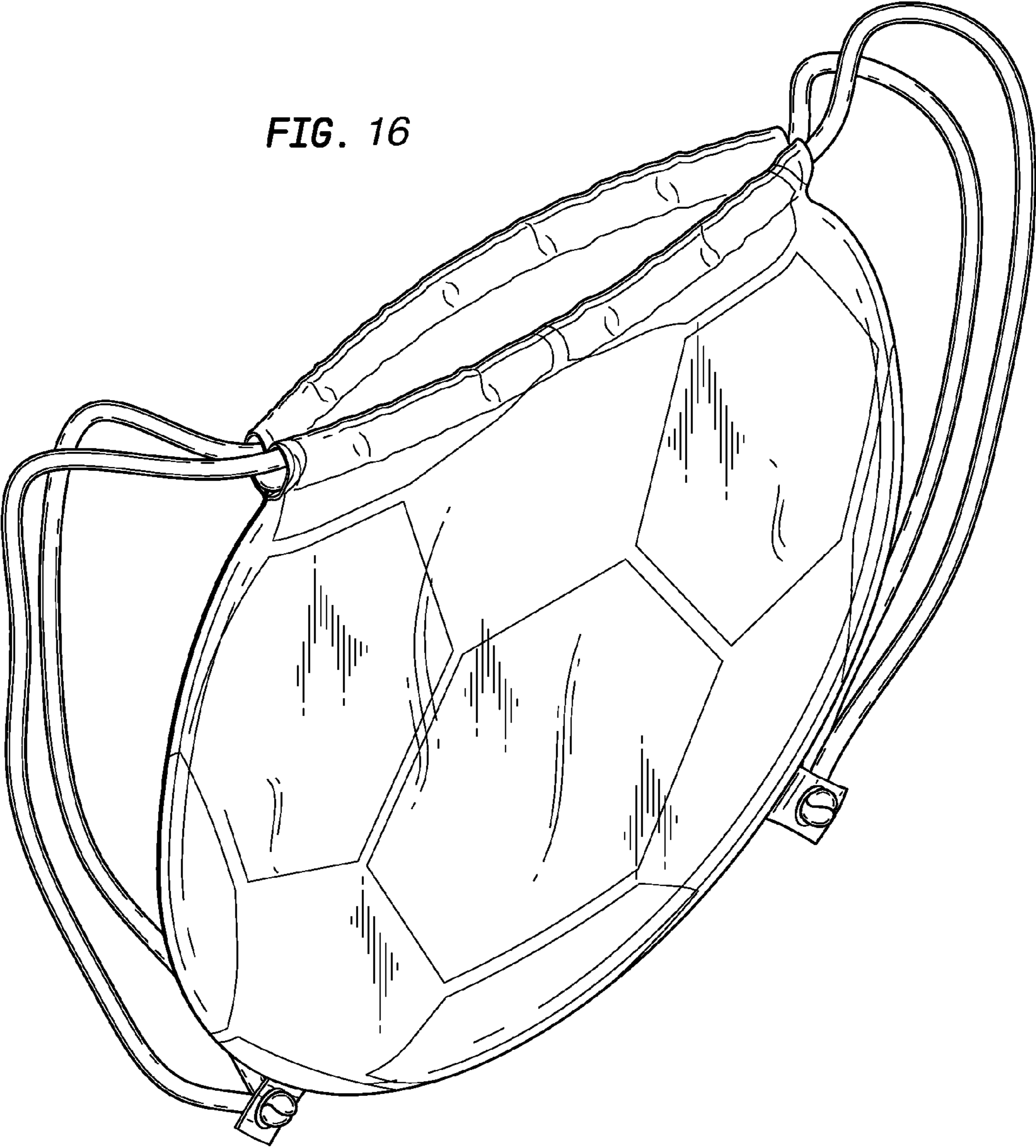

FIG. 17

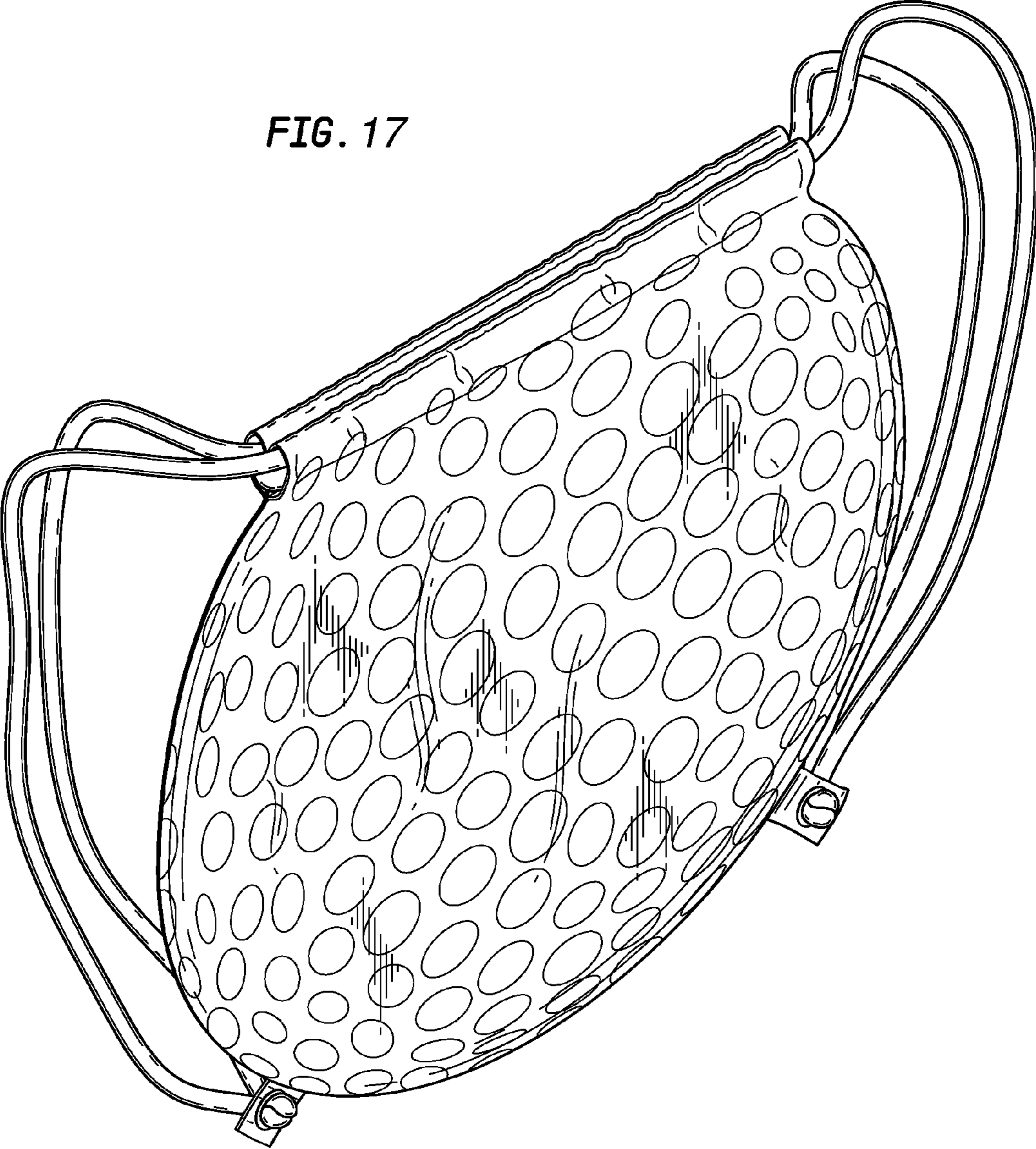

FIG. 18

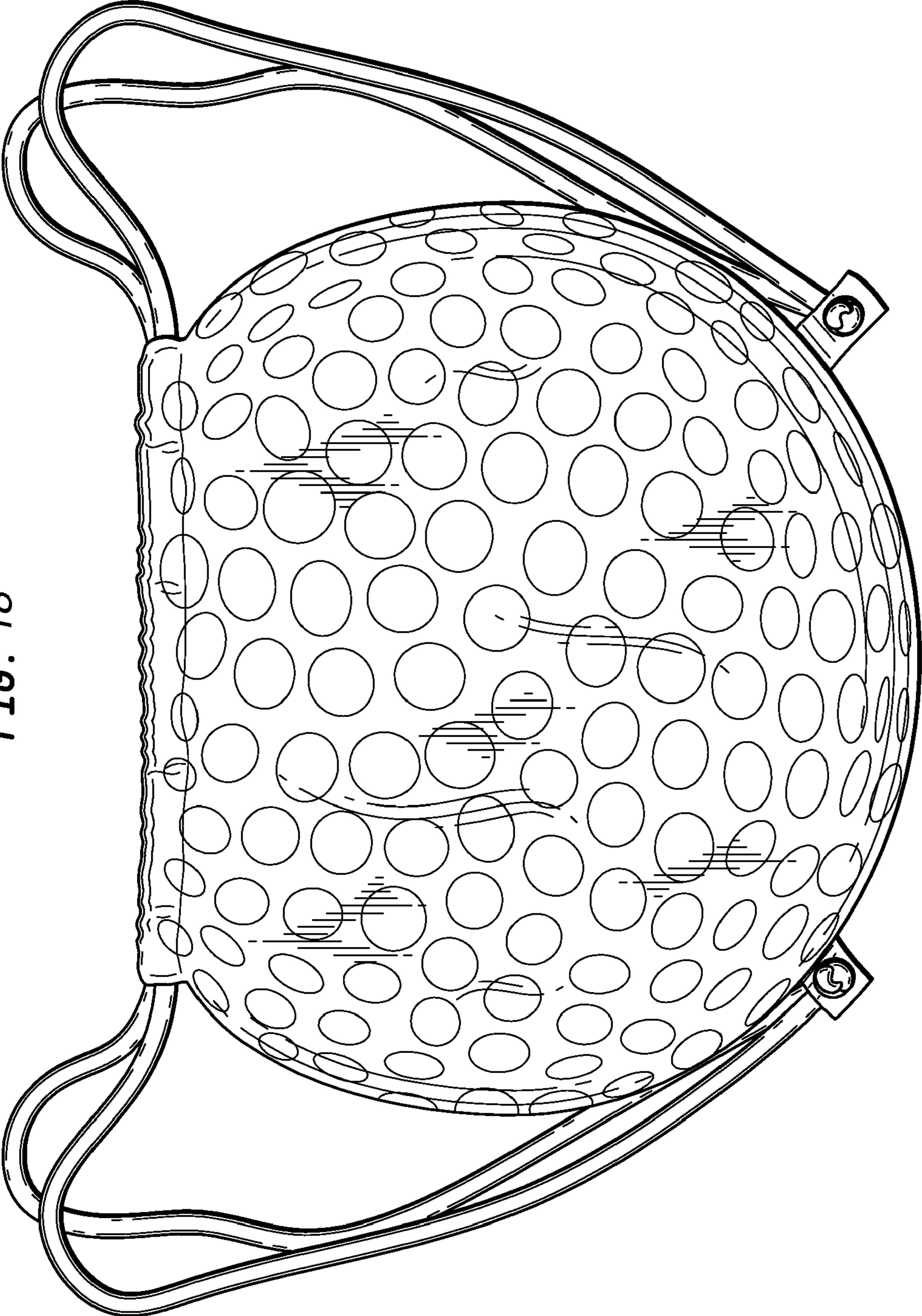

FIG. 19

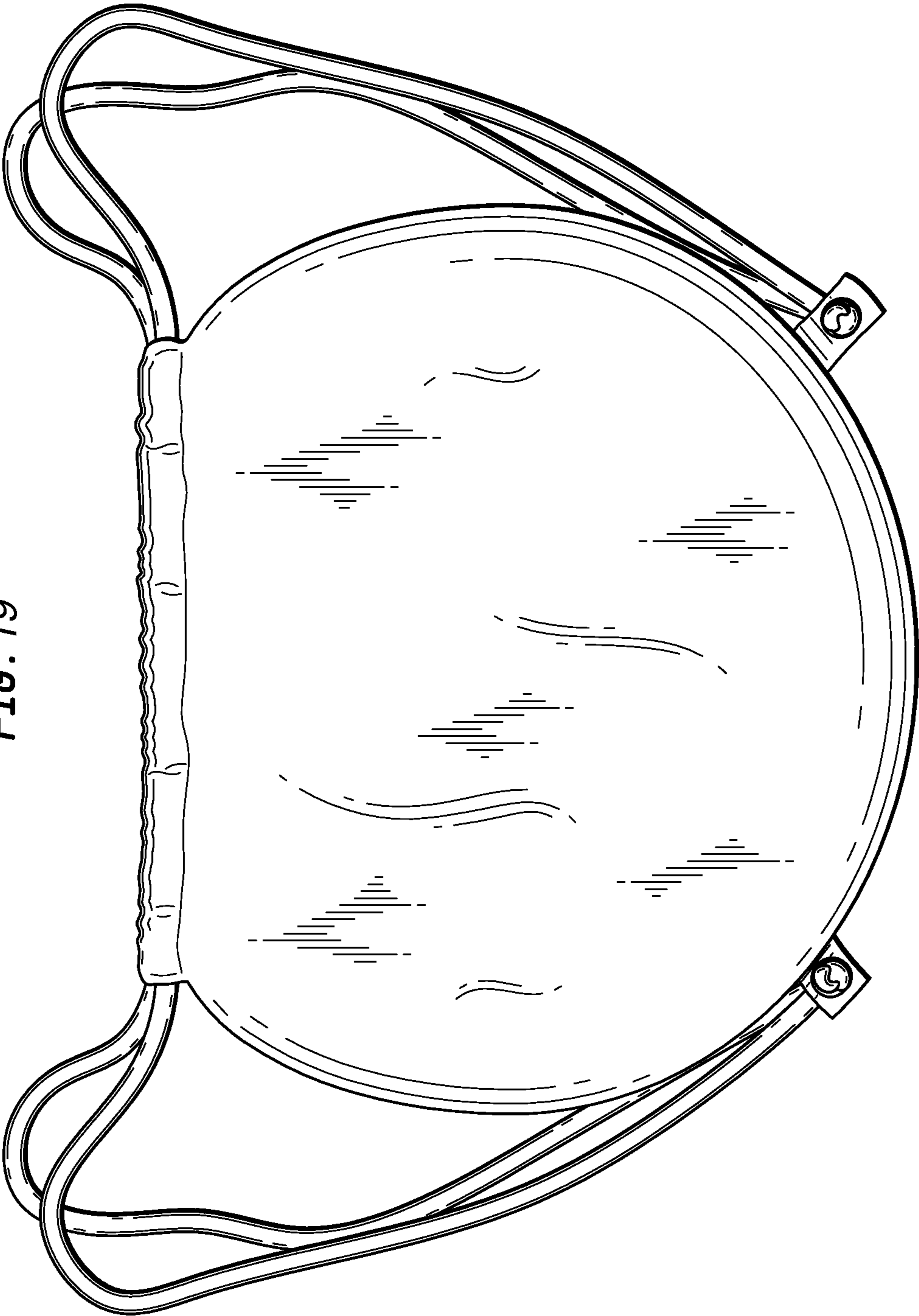

FIG. 20

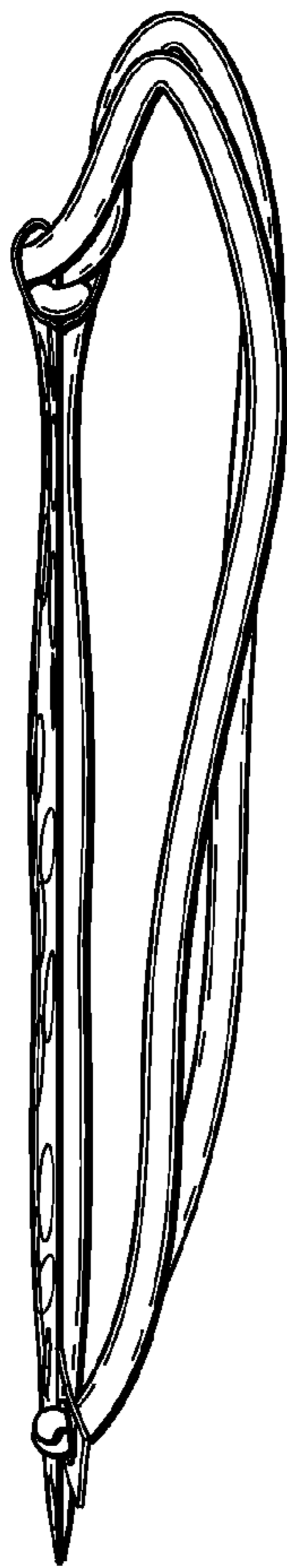

FIG. 21

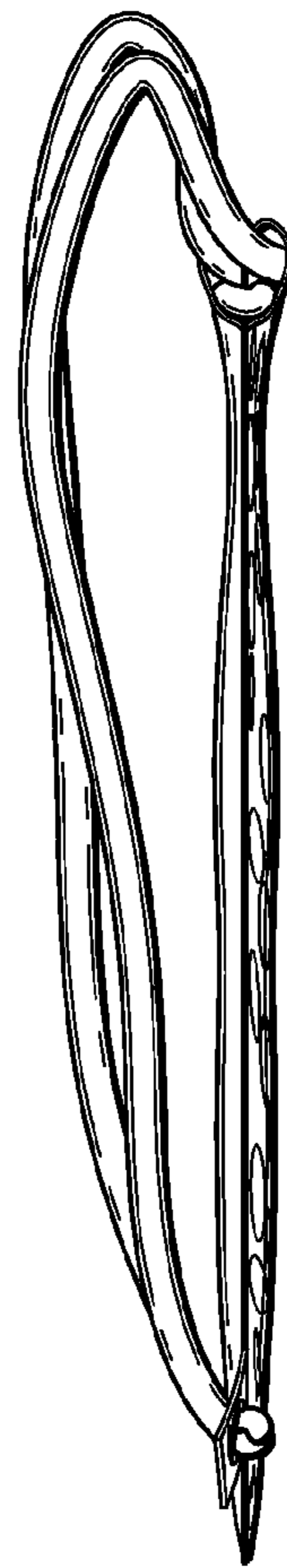

FIG. 22



FIG. 23

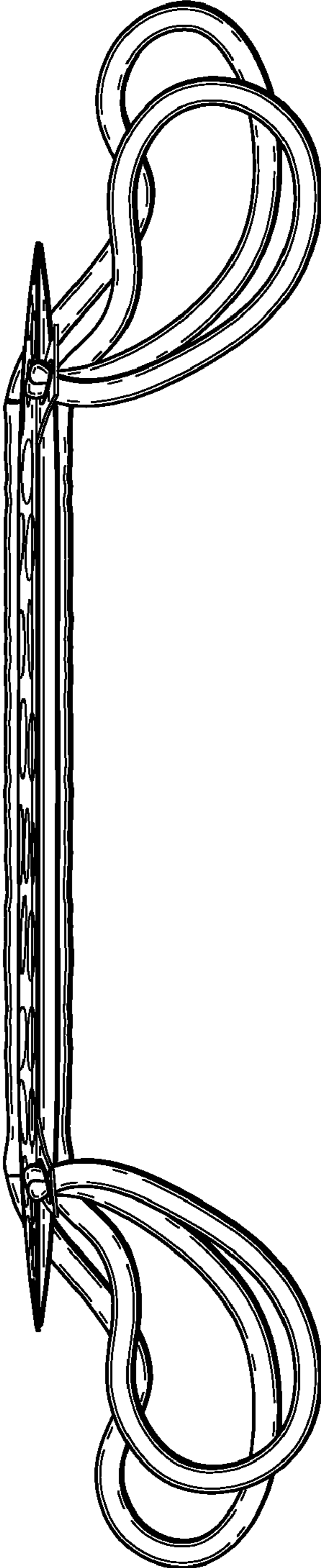

FIG. 24

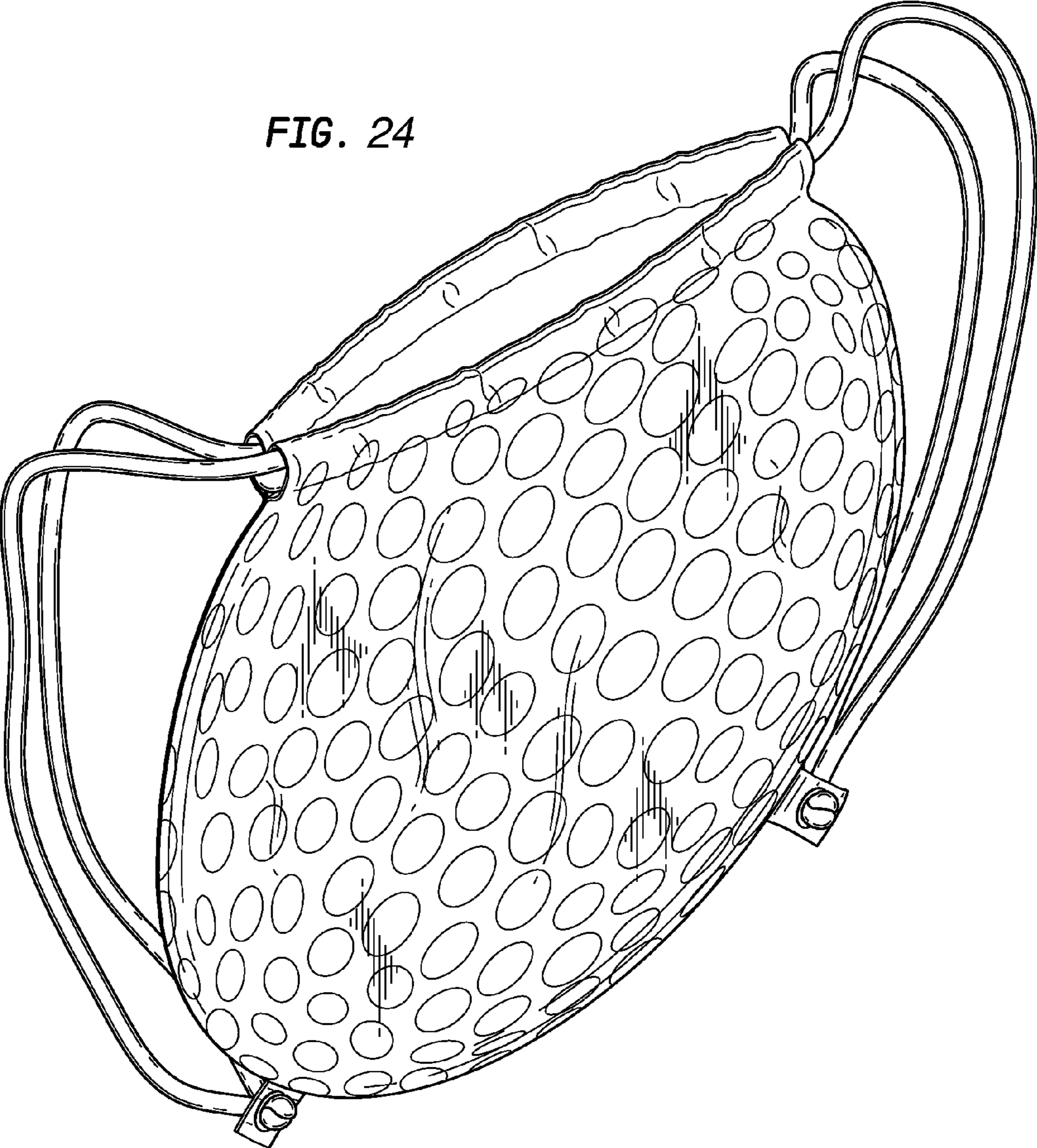

FIG. 25

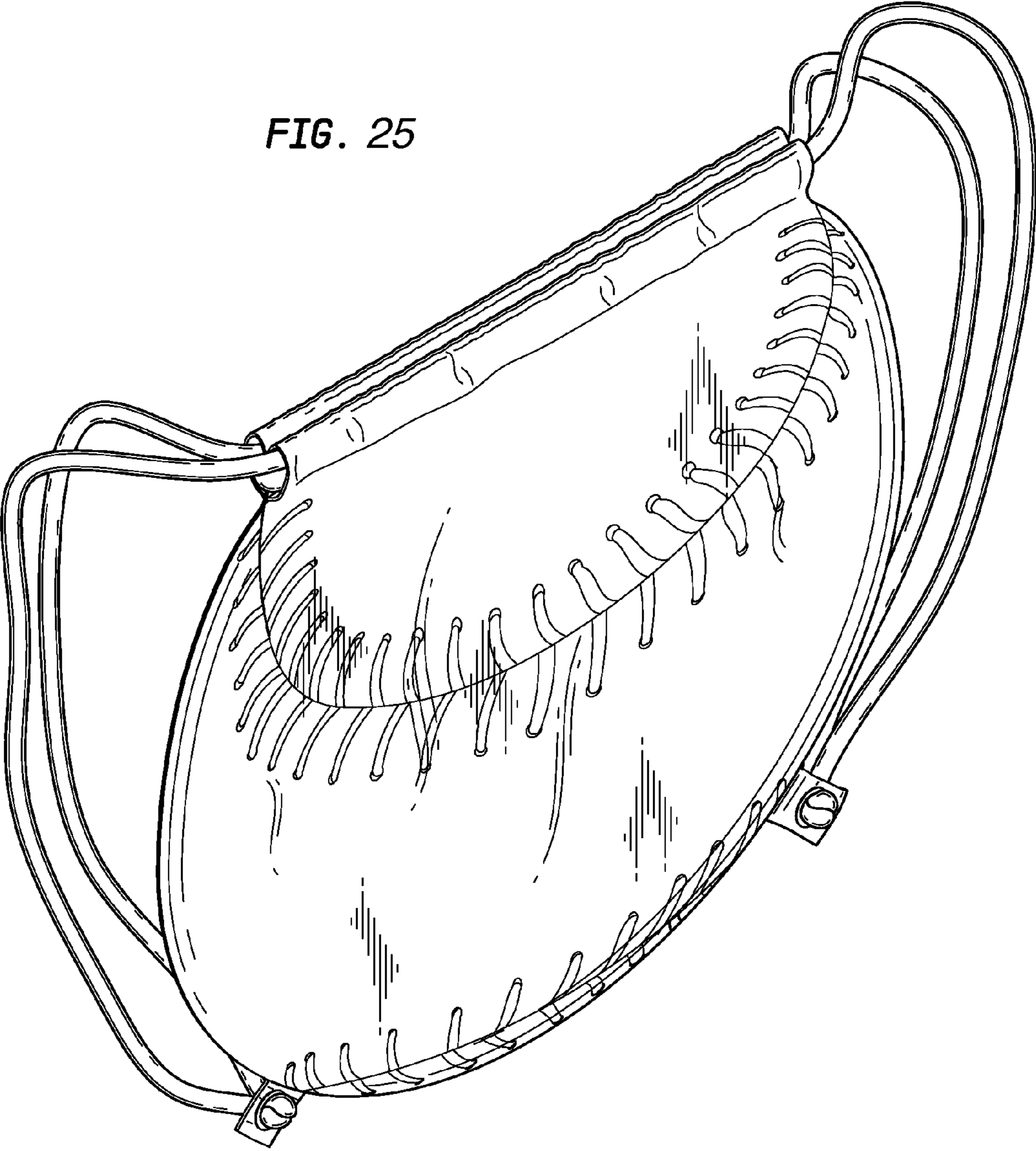

FIG. 26

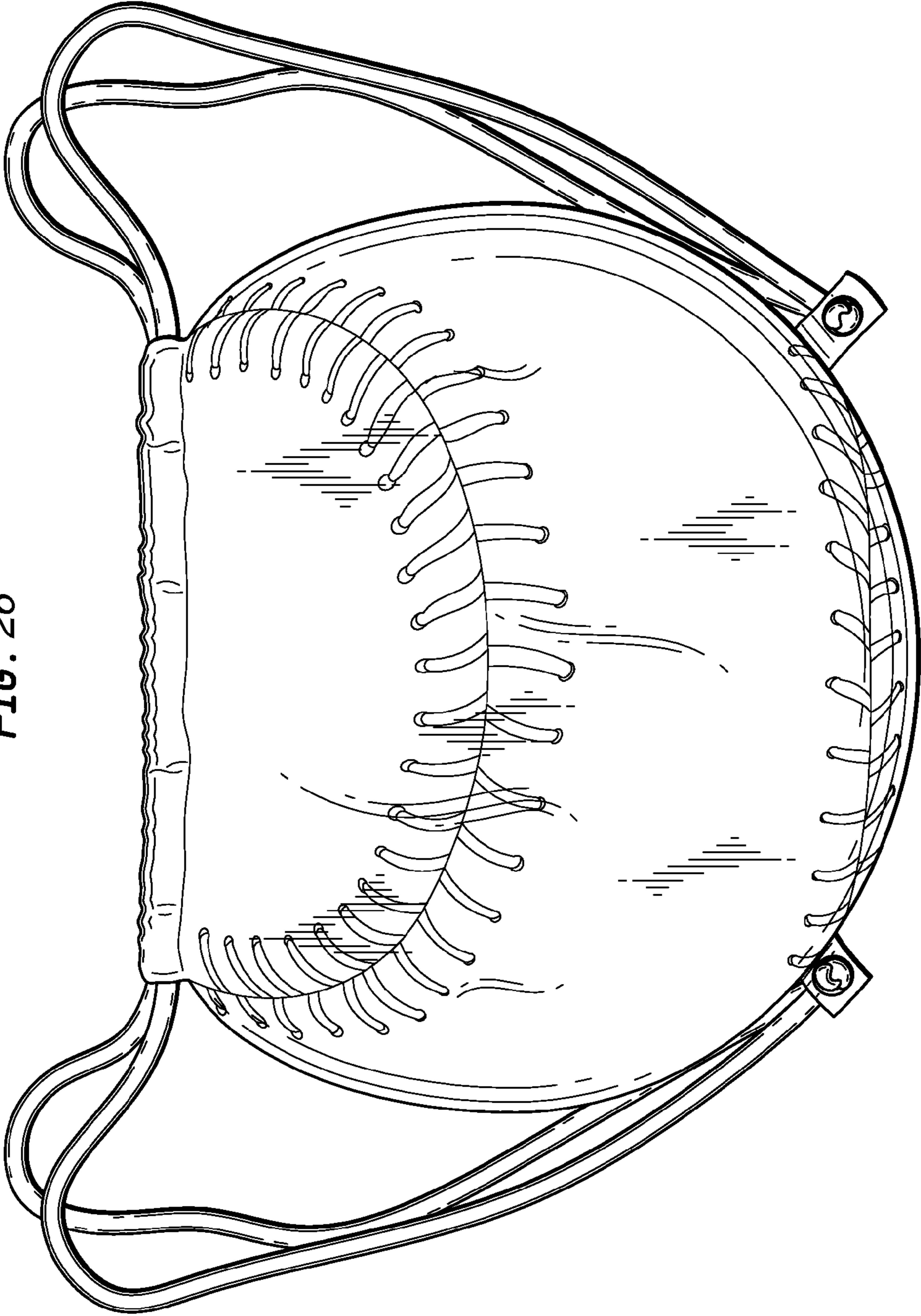

FIG. 27

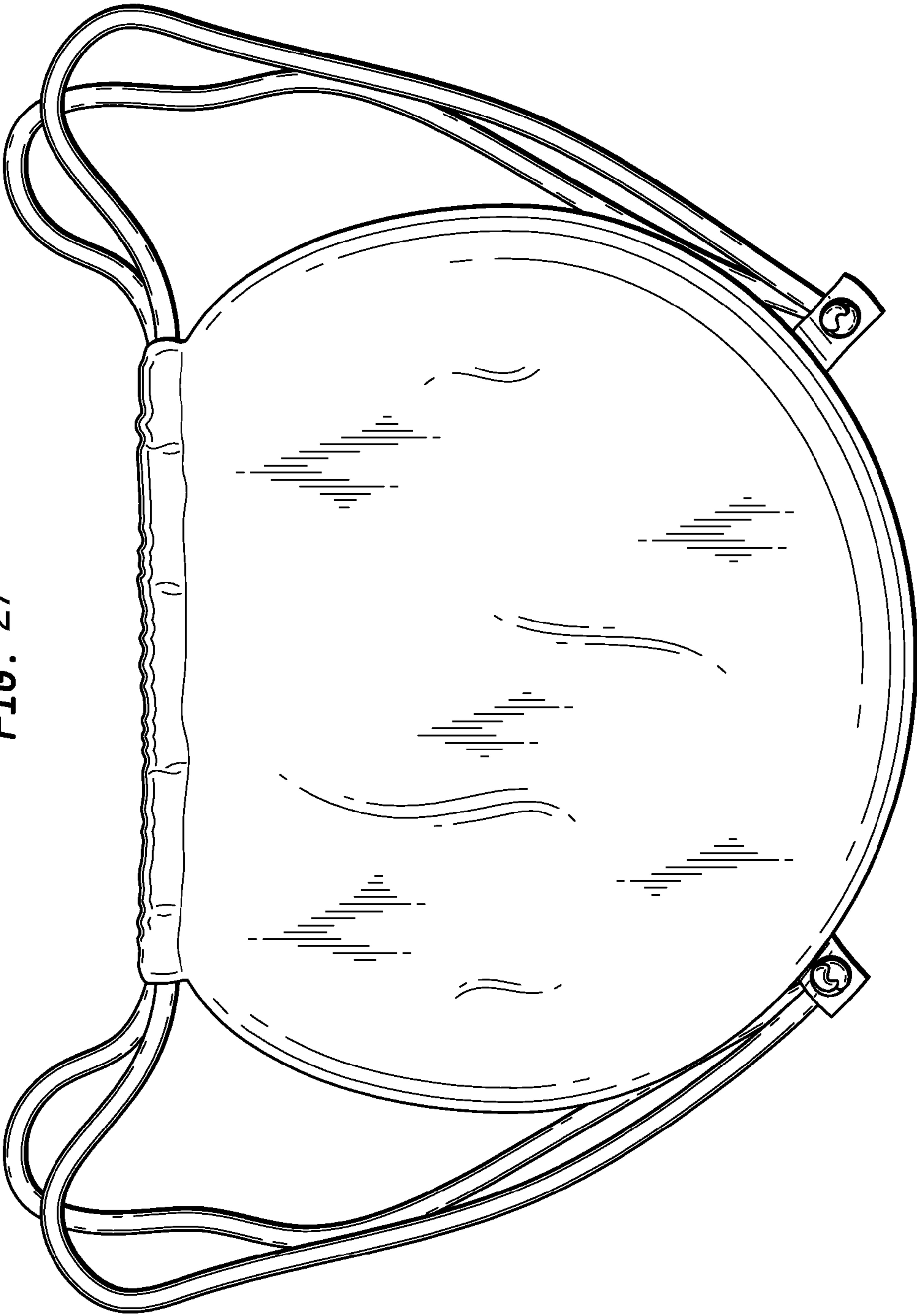

FIG. 28

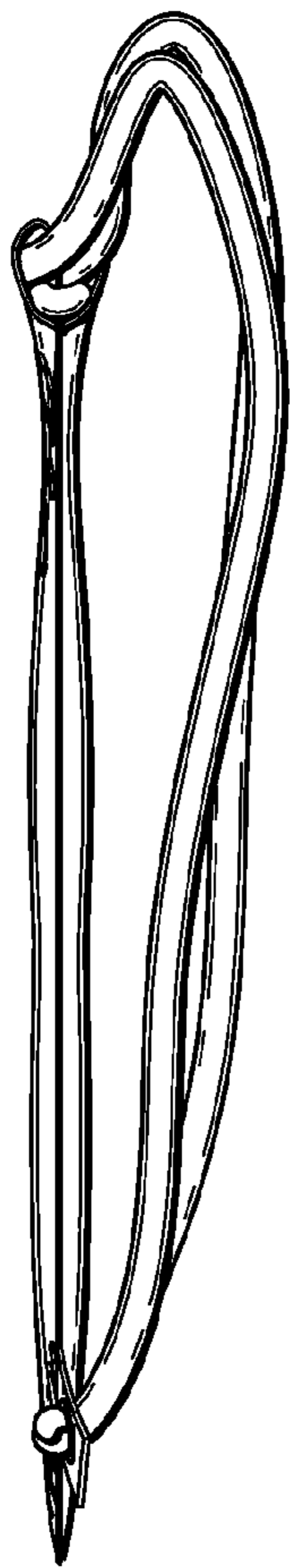

FIG. 29

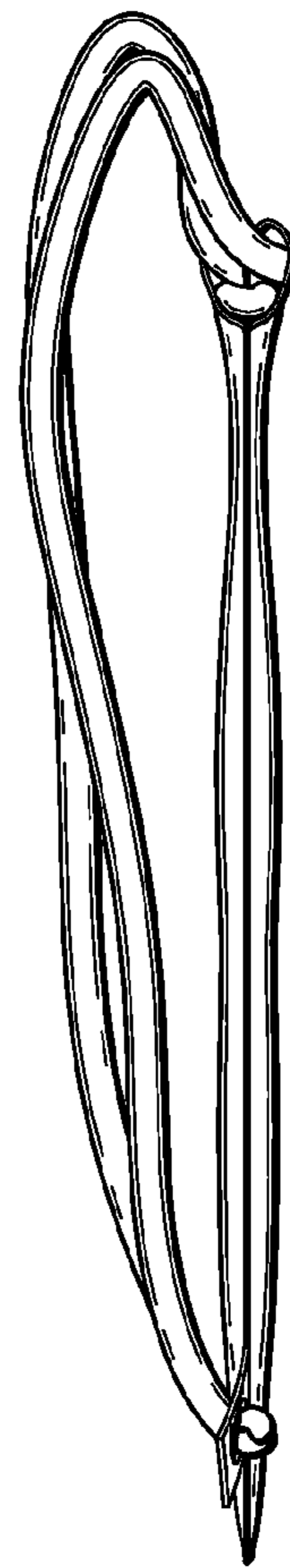

FIG. 30

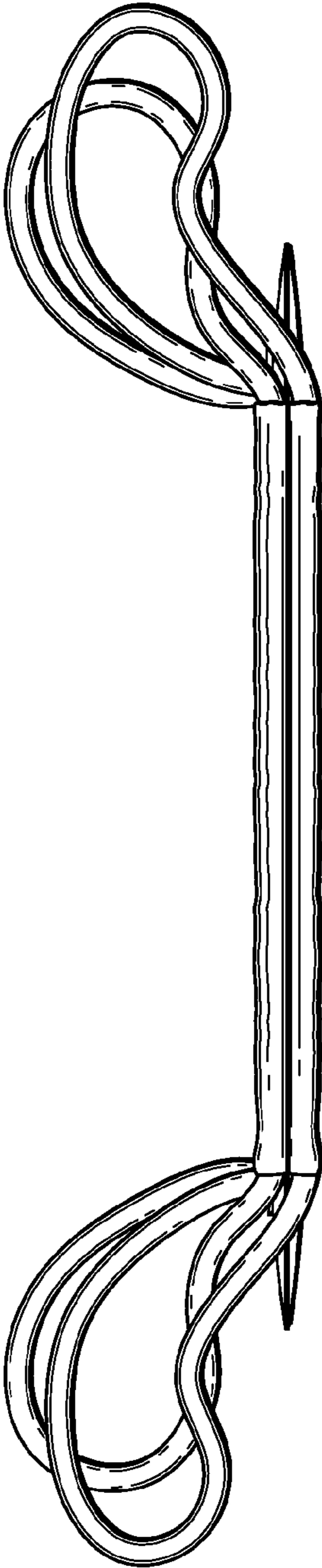

FIG. 31

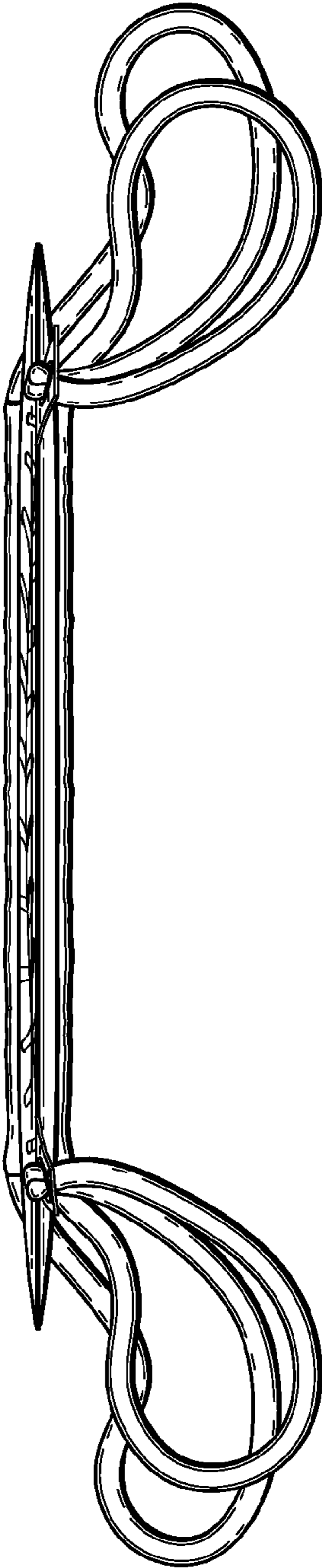

FIG. 32

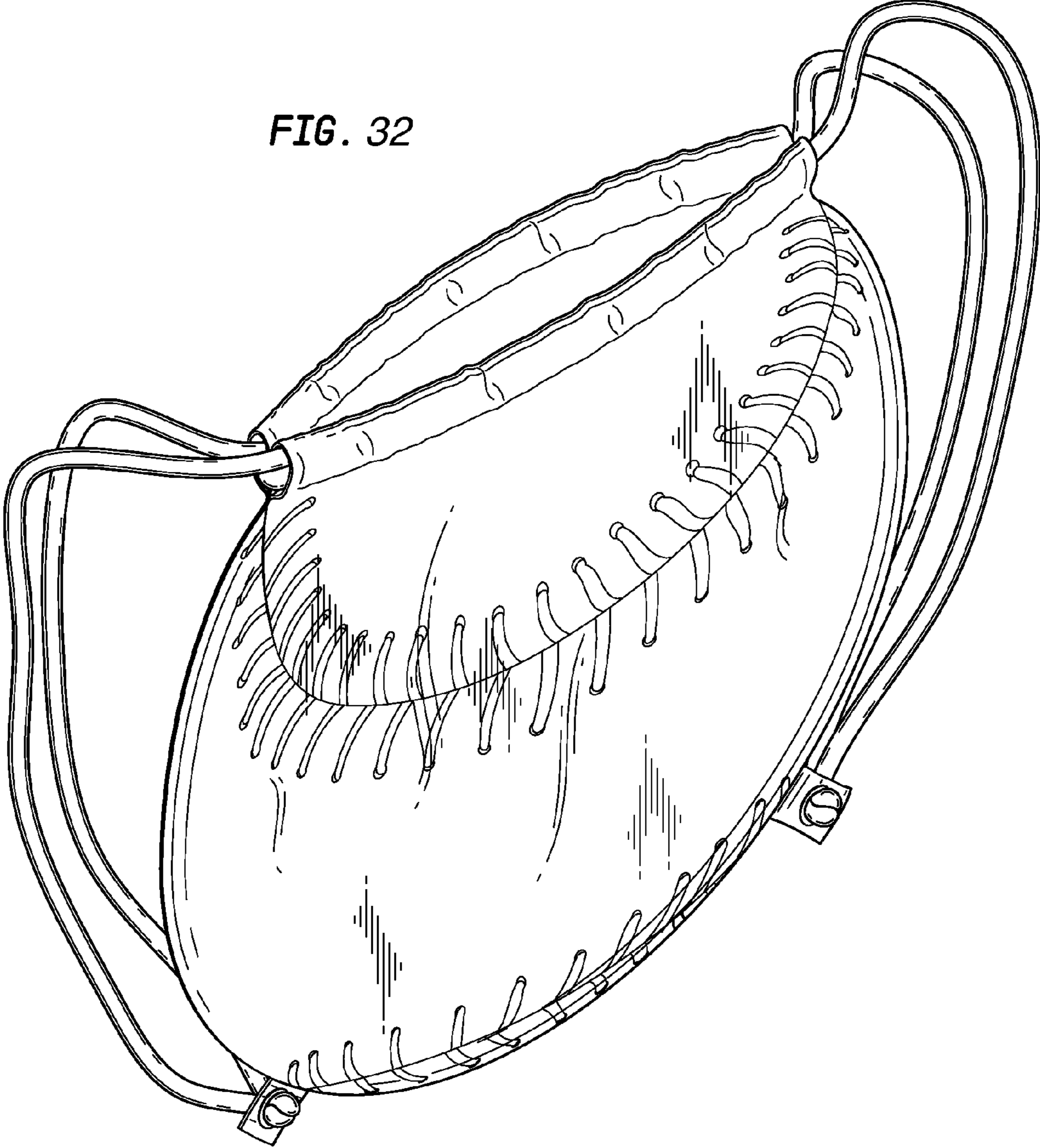

FIG. 33

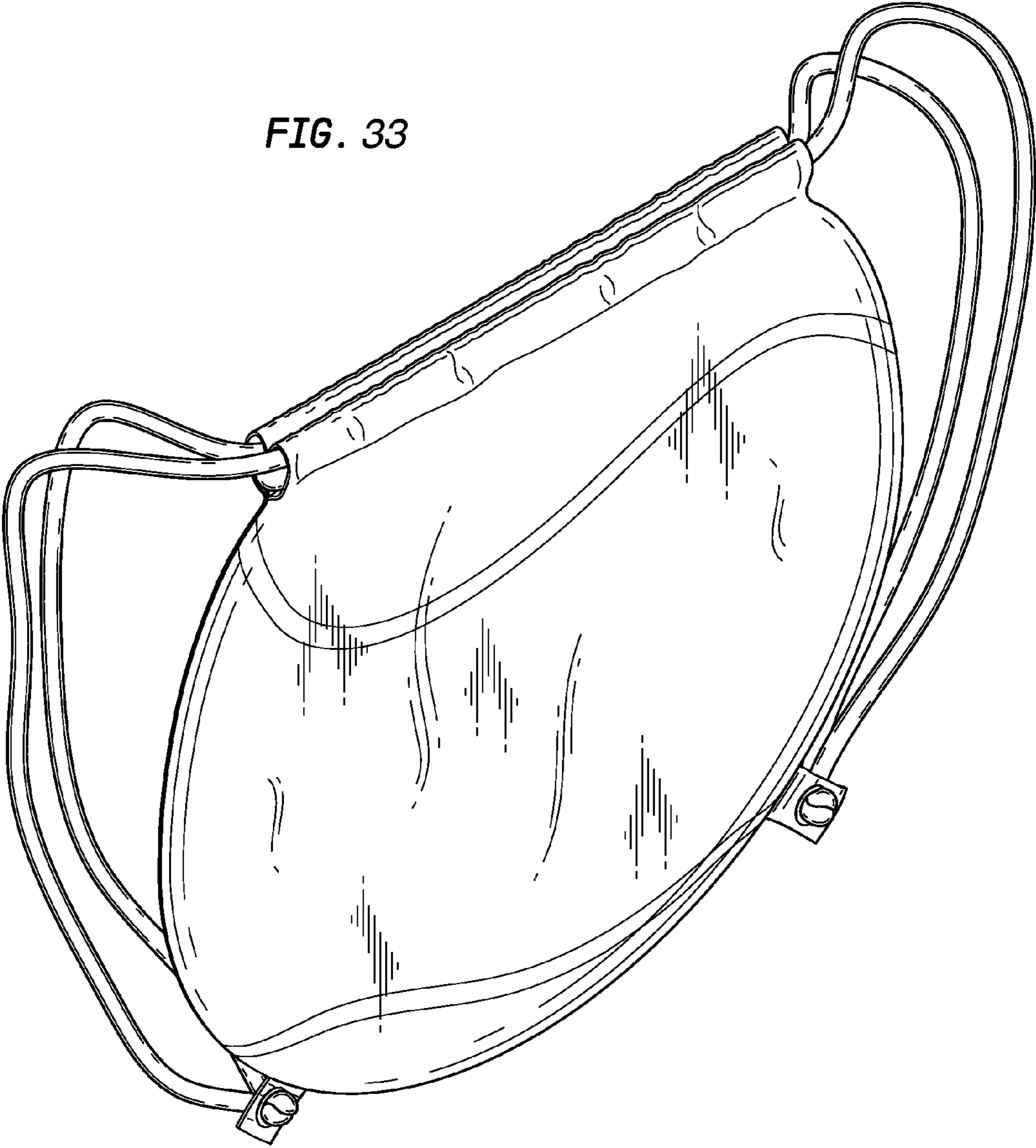

FIG. 34

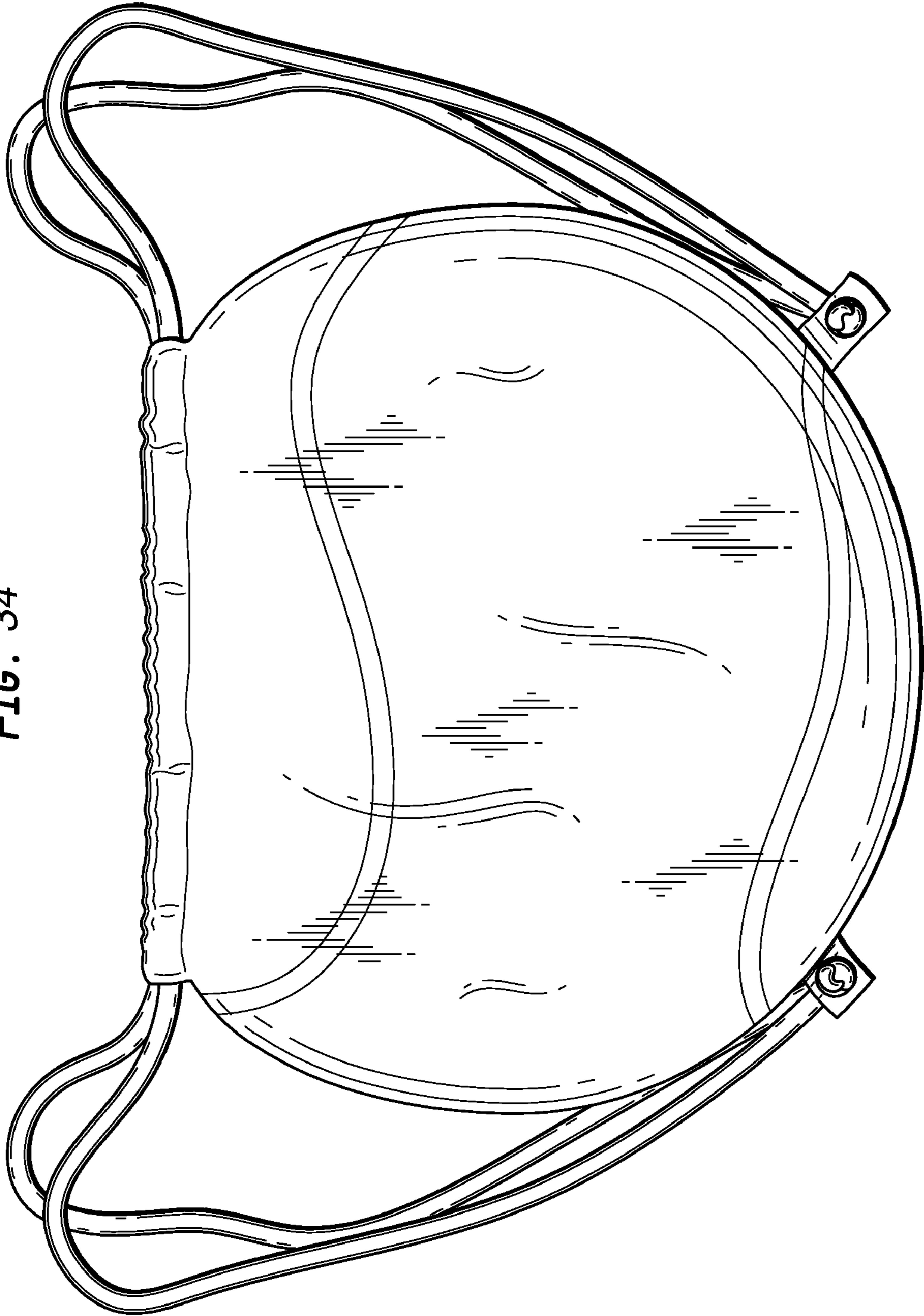

FIG. 35

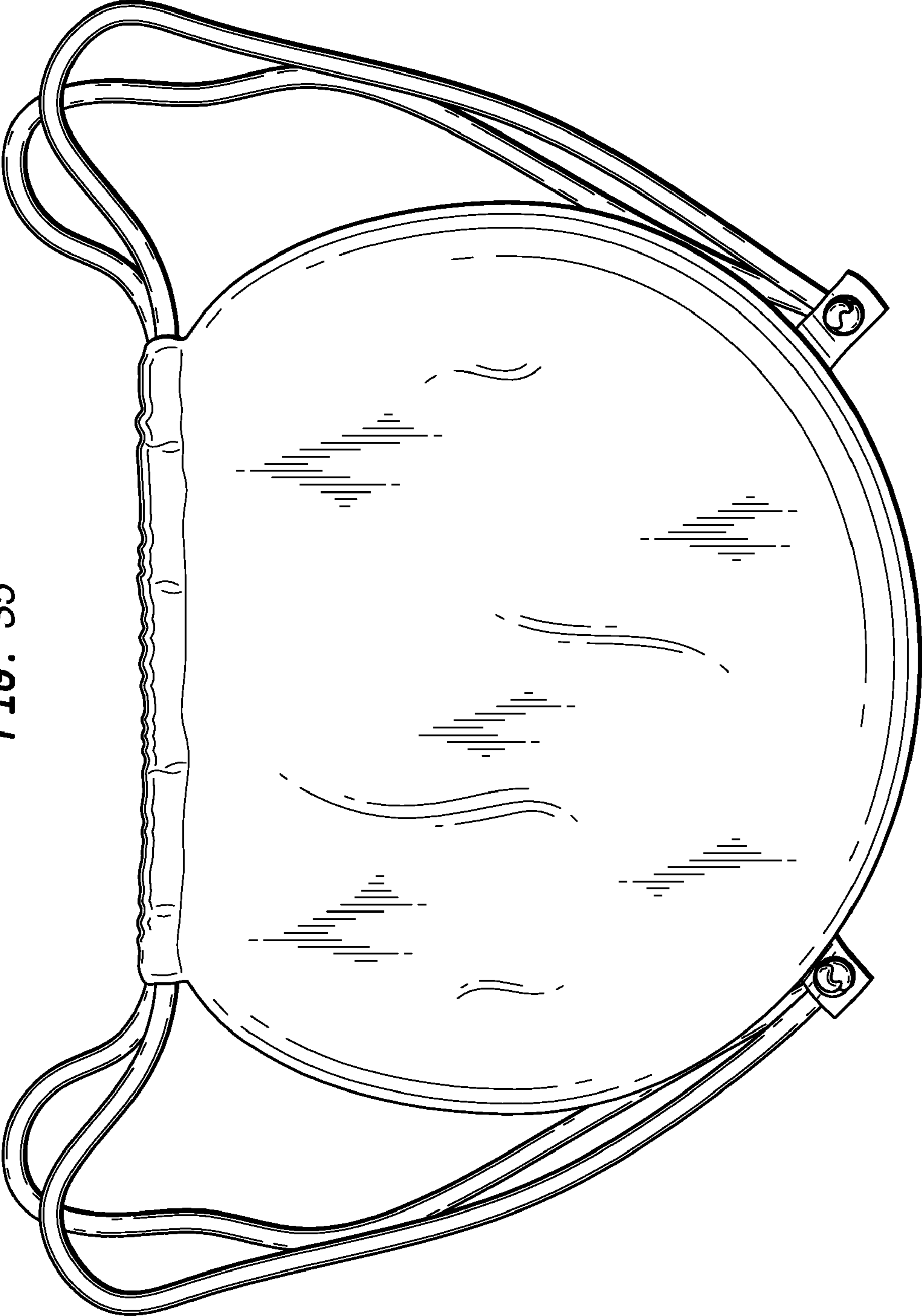

FIG. 36

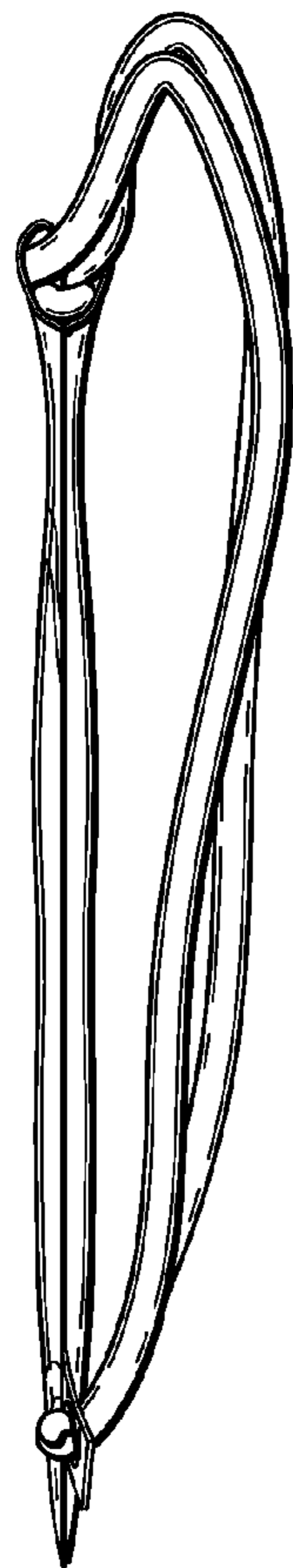

FIG. 37



FIG. 38



FIG. 39

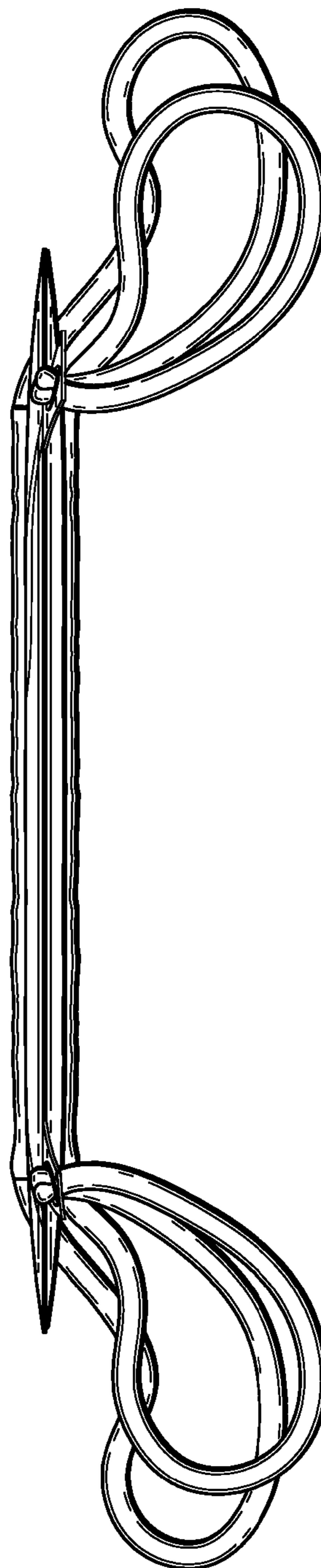

FIG. 40

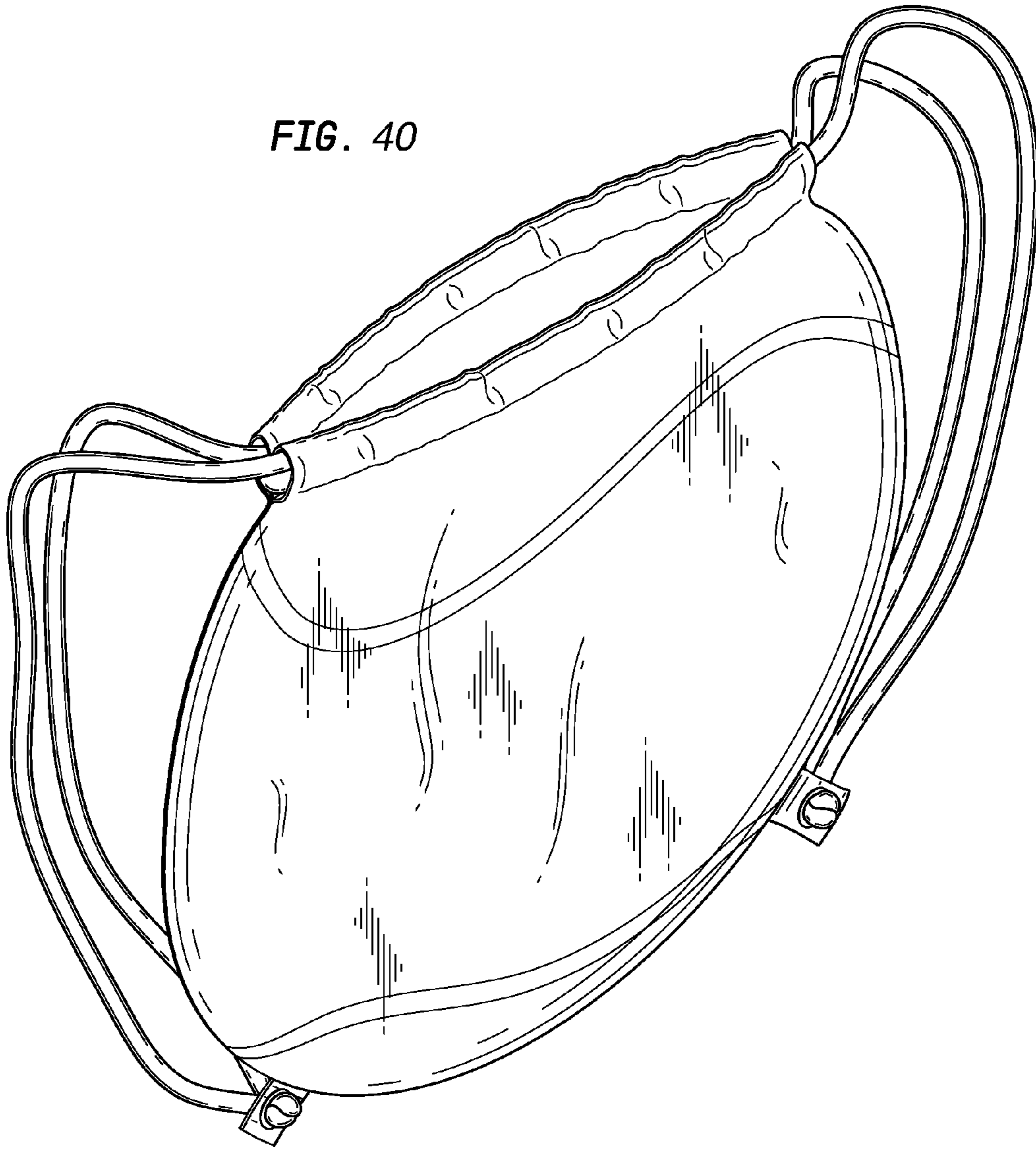

FIG. 41

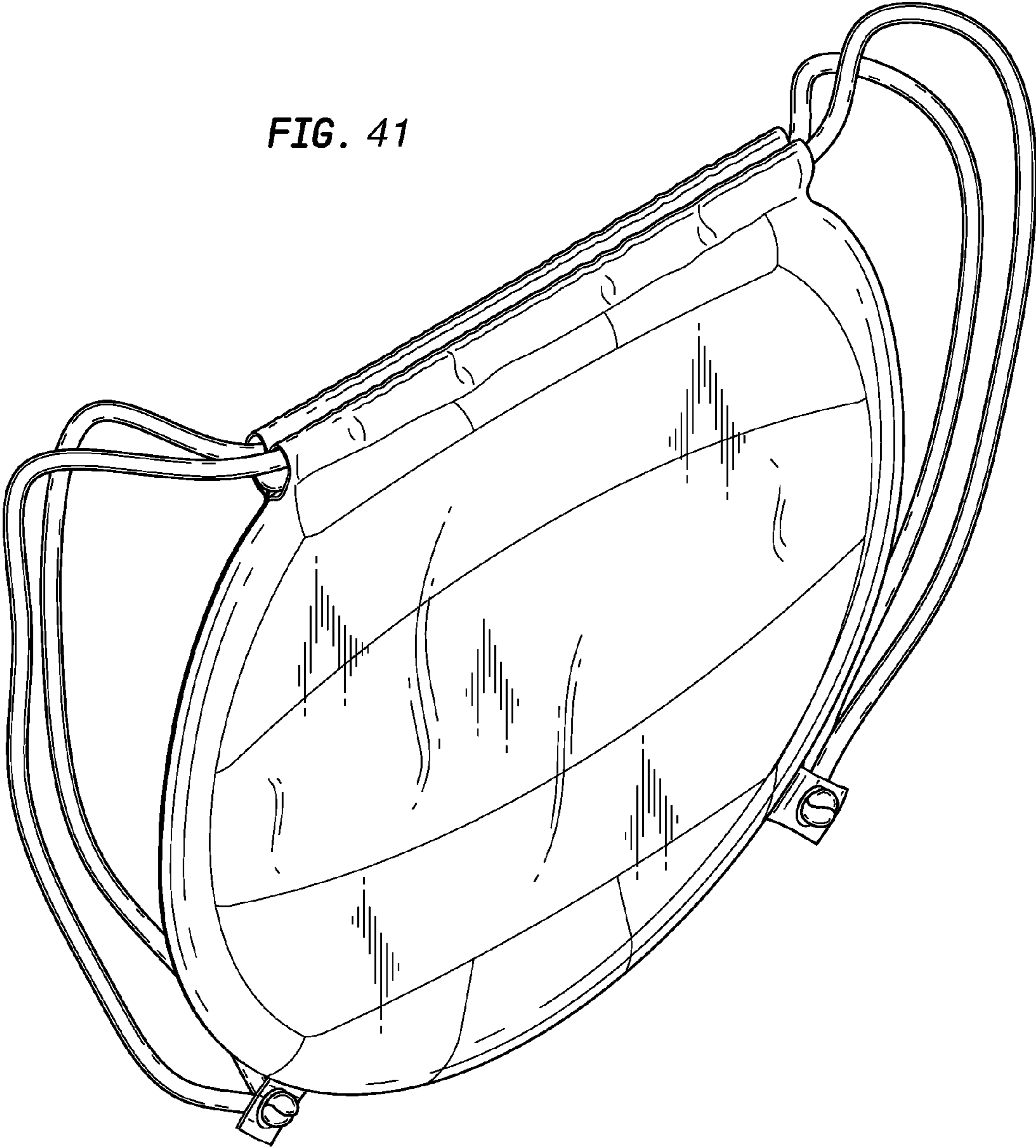

FIG. 42

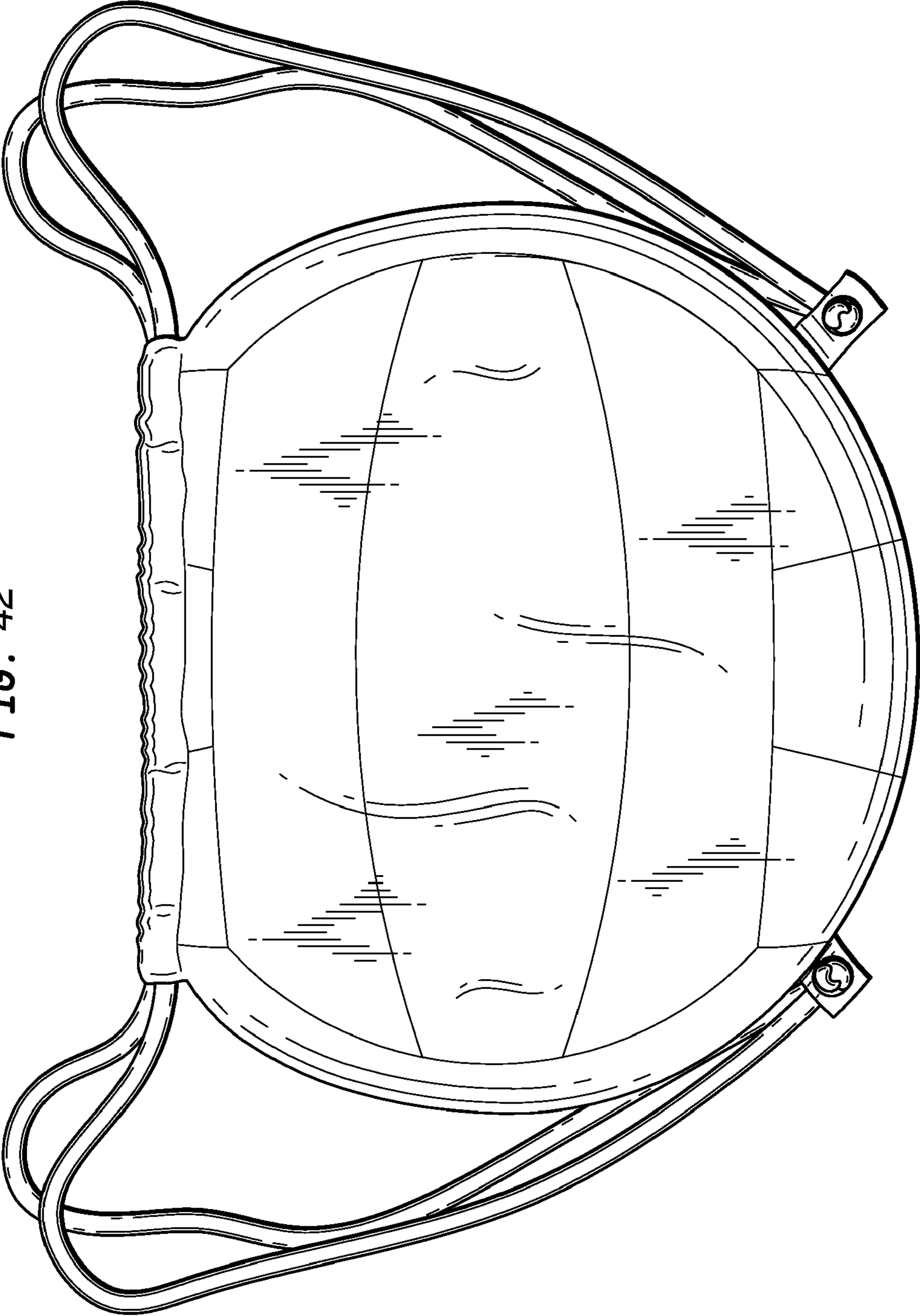

FIG. 43

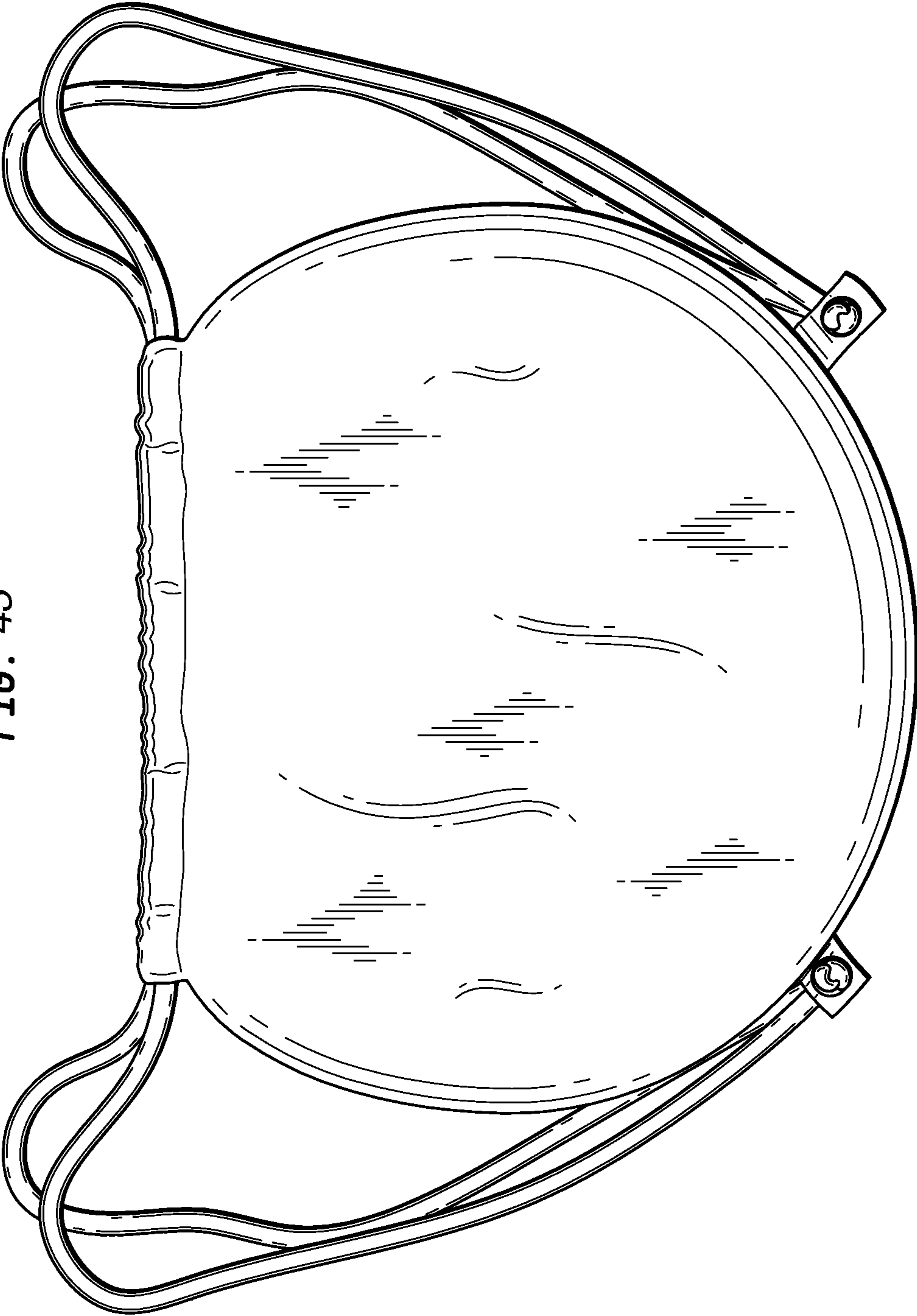

FIG. 44

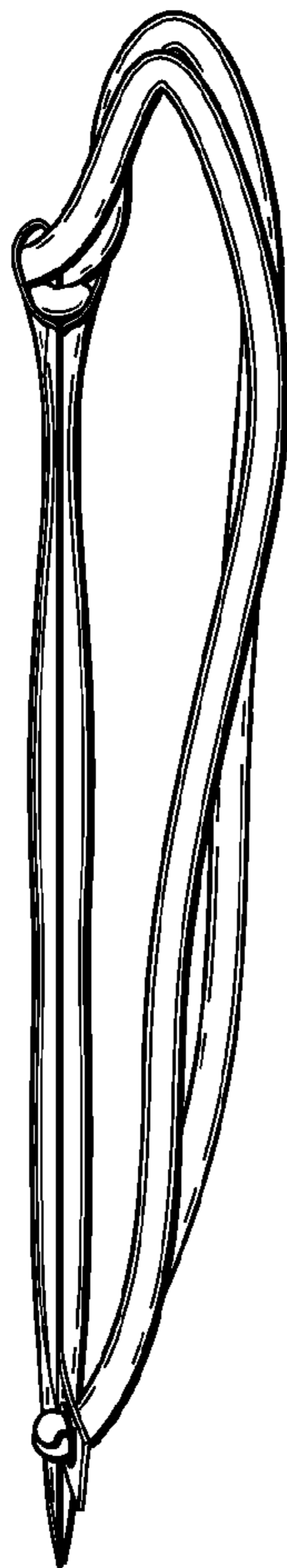

FIG. 45

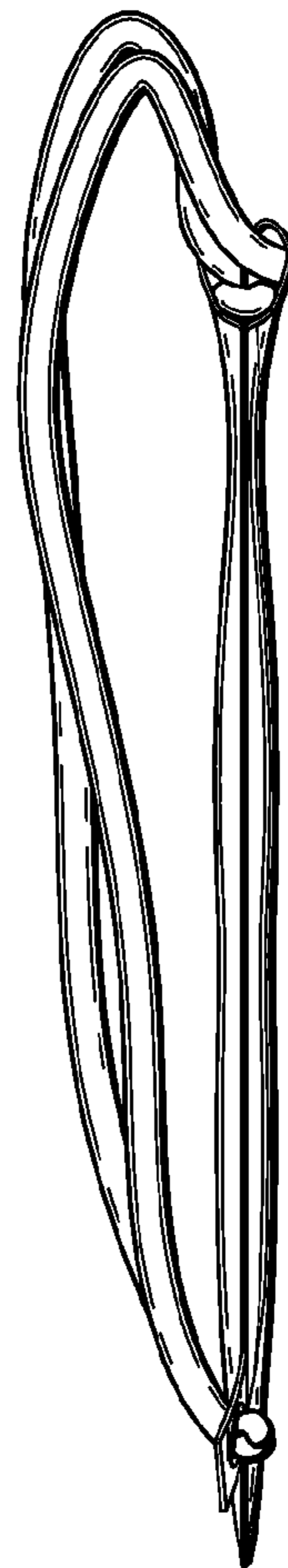

FIG. 46

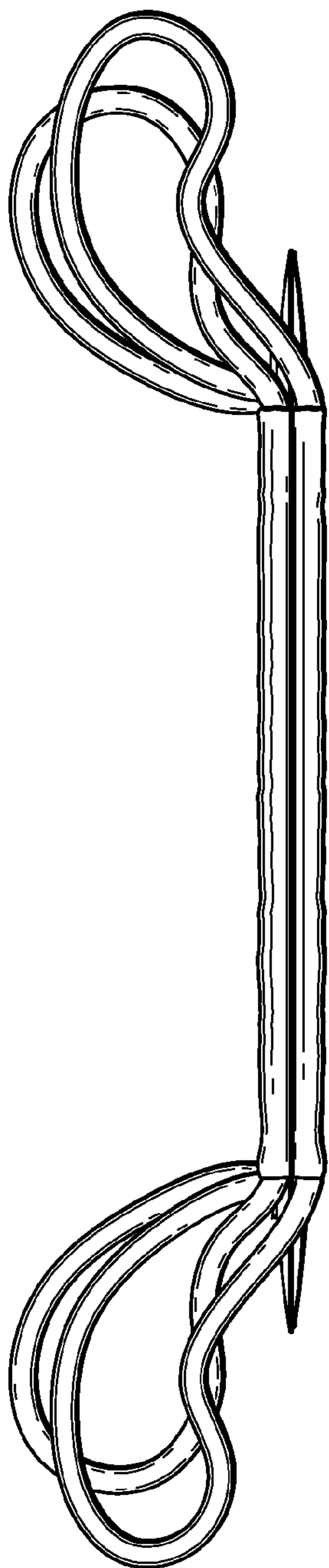

FIG. 47

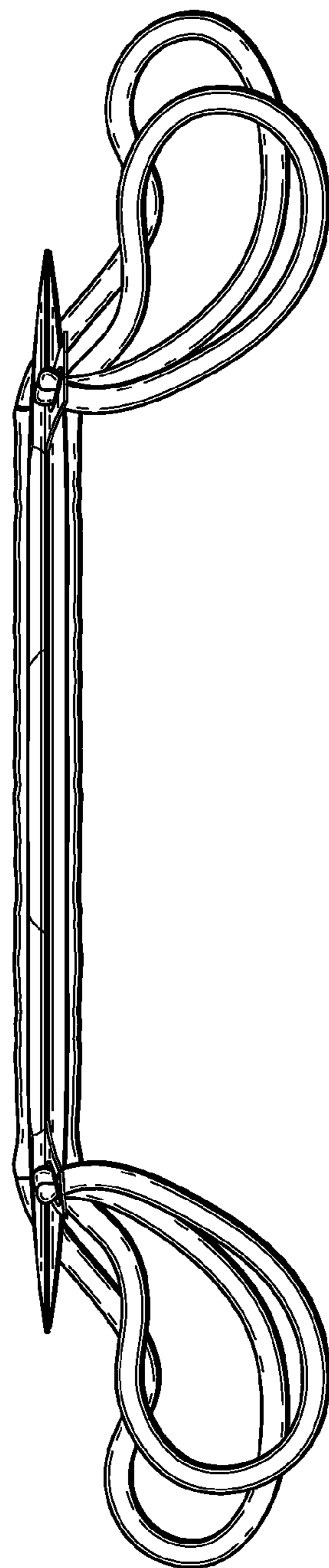

FIG. 48

