



US00D646046S

(12) **United States Design Patent**  
**Paine**

(10) **Patent No.:** **US D646,046 S**

(45) **Date of Patent:** **\*\* Oct. 4, 2011**

(54) **FOOTWEAR PULLER**

(76) Inventor: **Garry Paine**, Kirkwood, MO (US)

(\*\*) Term: **14 Years**

(21) Appl. No.: **29/339,217**

(22) Filed: **Jun. 26, 2009**

**Related U.S. Application Data**

(63) Continuation-in-part of application No. 29/326,486, filed on Oct. 20, 2008, now abandoned.

(51) **LOC (9) Cl.** ..... **07-99**

(52) **U.S. Cl.** ..... **D2/642**

(58) **Field of Classification Search** ..... D2/641,  
D2/642, 643; 223/111, 112, 113, 114, 115,  
223/116, 117, 118, 119

See application file for complete search history.

(56) **References Cited**

**U.S. PATENT DOCUMENTS**

D6,535 S *	3/1873	Fogelstrand	.....	D2/642
846,694 A	3/1907	Paul		
1,293,318 A	2/1919	LaBoissier		
D143,819 S *	2/1946	Hauret	.....	D2/642
D159,714 S	8/1950	Brackin		
D164,768 S *	10/1951	Fowler	.....	D27/107
D229,118 S	11/1973	Shechtman et al.		
D229,377 S *	11/1973	Johnson	.....	D6/416
3,784,057 A *	1/1974	Tuttle	.....	221/196
D245,129 S *	7/1977	Adams et al.	.....	D11/232
D250,866 S *	1/1979	Mulligan	.....	D6/404
D257,188 S *	10/1980	Blicha	.....	D2/642
D259,301 S *	5/1981	Cowart et al.	.....	D2/642
4,355,744 A	10/1982	Dudley		
D320,109 S	9/1991	Chew		
5,050,784 A	9/1991	Turner		
D354,841 S *	1/1995	Bussell	.....	D2/642

5,566,868 A	10/1996	Mariscal et al.		
D503,544 S *	4/2005	Scanlan	.....	D6/320
D613,034 S *	4/2010	Gulley	.....	D2/642
D619,928 S *	7/2010	Bodino et al.	.....	D11/231
D628,866 S *	12/2010	Serret	.....	D8/17

\* cited by examiner

*Primary Examiner* — T. Chase Nelson

*Assistant Examiner* — Kathleen M Sims

(74) *Attorney, Agent, or Firm* — Polster, Lieder, Woodruff & Lucchesi, LC

(57) **CLAIM**

The ornamental design for a footwear puller, as shown and described.

**DESCRIPTION**

FIG. 1 is a front perspective view of a first embodiment of a footwear puller showing my new design;

FIG. 2 is a front view thereof;

FIG. 3 is a rear view thereof;

FIG. 4 is a right side elevational view thereof;

FIG. 5 is a left side elevational view thereof;

FIG. 6 is a top view thereof;

FIG. 7 is a bottom view thereof;

FIG. 8 is a front perspective view of a second embodiment of a footwear puller showing my new design;

FIG. 9 is a front view thereof;

FIG. 10 is a rear view thereof;

FIG. 11 is a right side elevational view thereof;

FIG. 12 is a left side elevational view thereof;

FIG. 13 is a top view thereof; and,

FIG. 14 is a bottom view thereof.

The oblique shading lines in FIGS. 8-14 indicate an opaque refractory surface coating that conforms to the shape of the elements and features of the footwear puller illustrated therein.

**1 Claim, 4 Drawing Sheets**

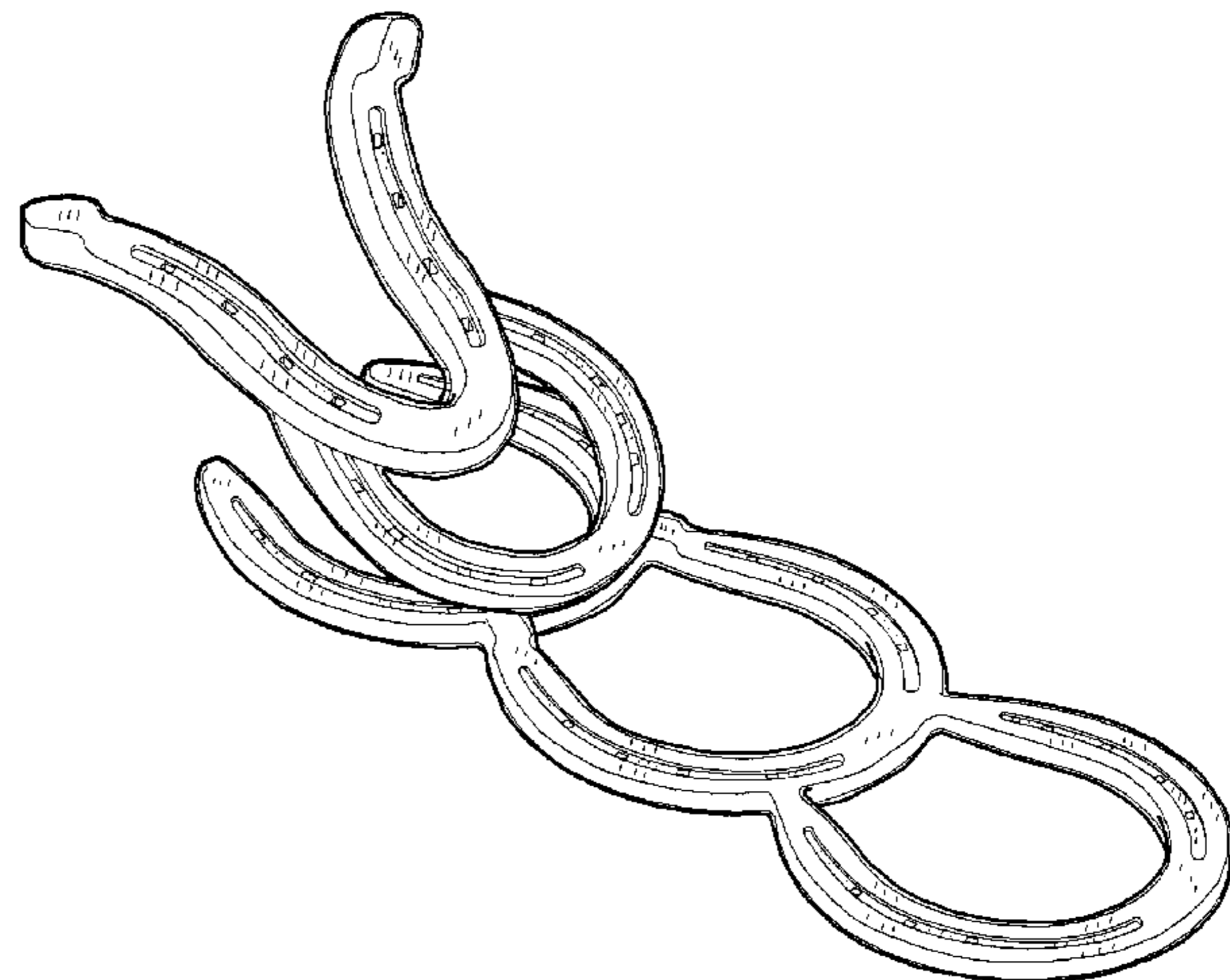
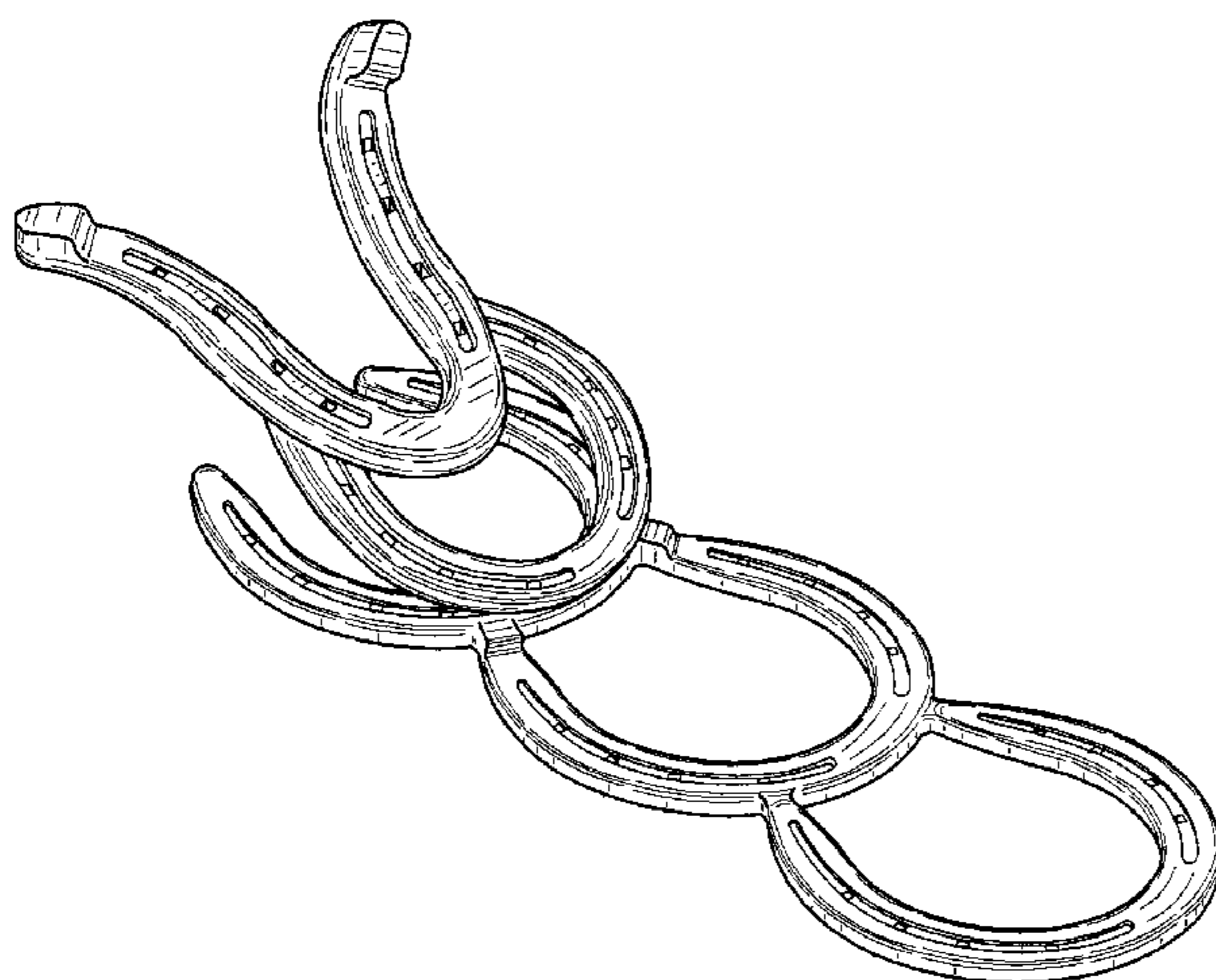

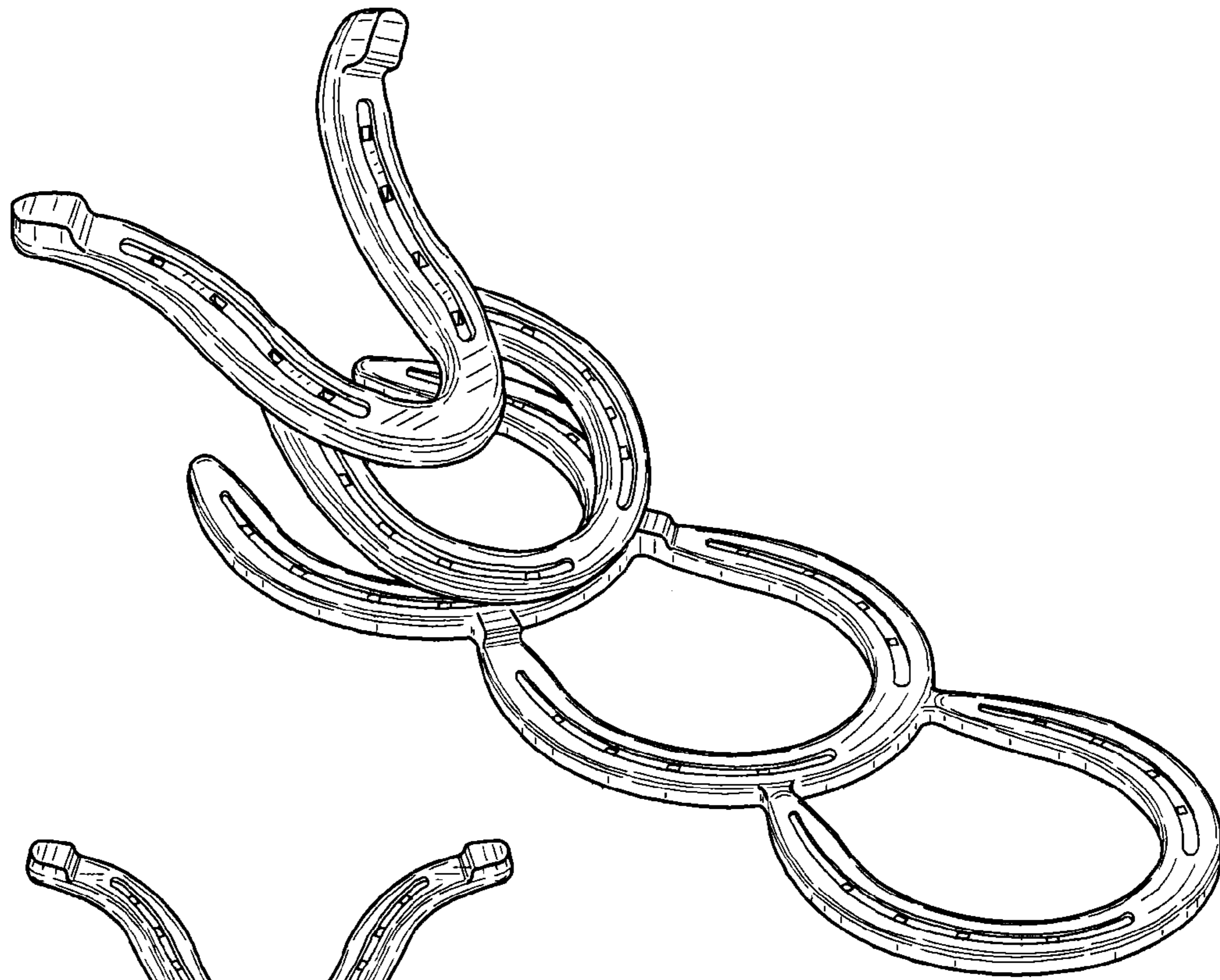

FIG. 1

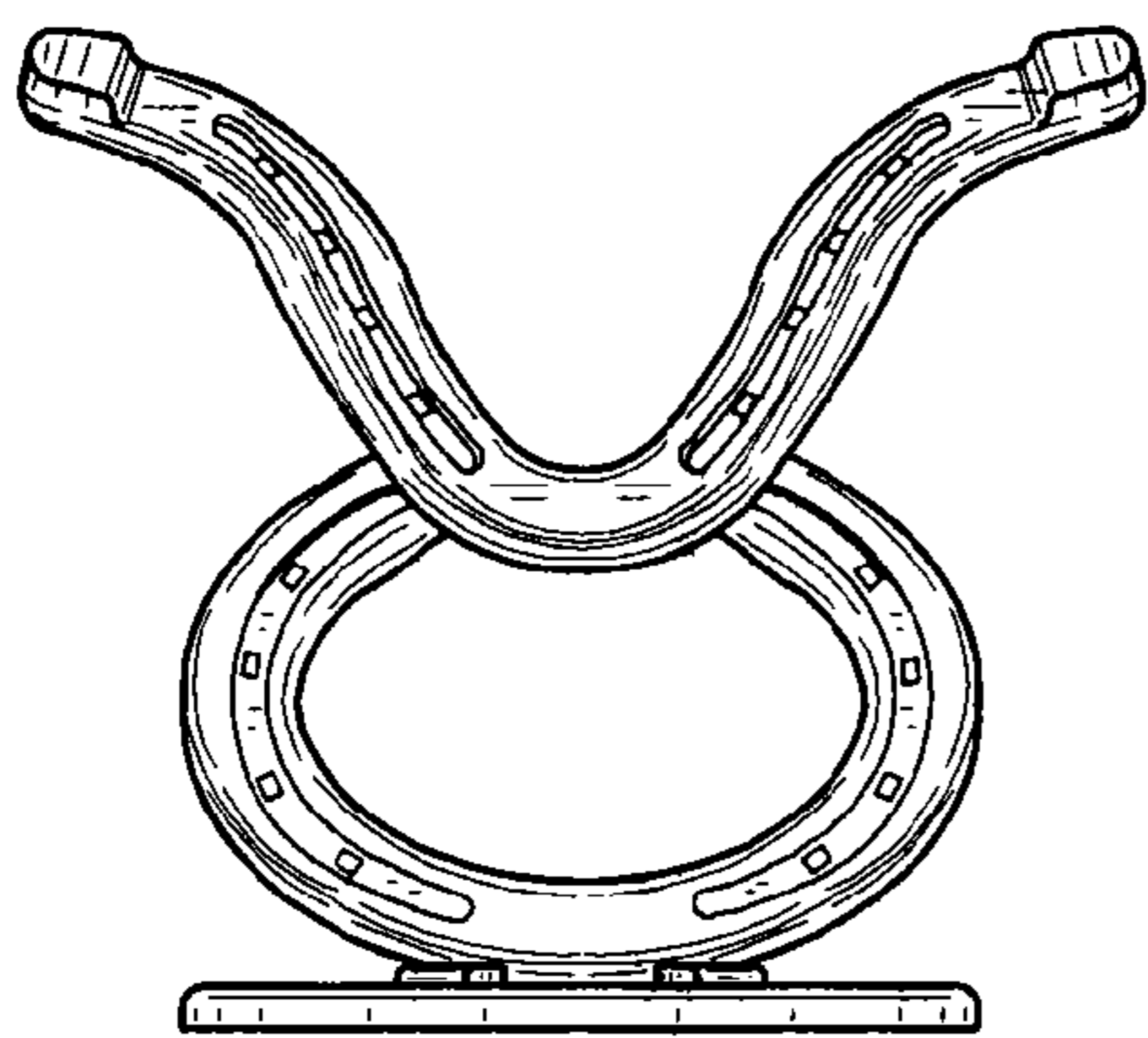

FIG. 2

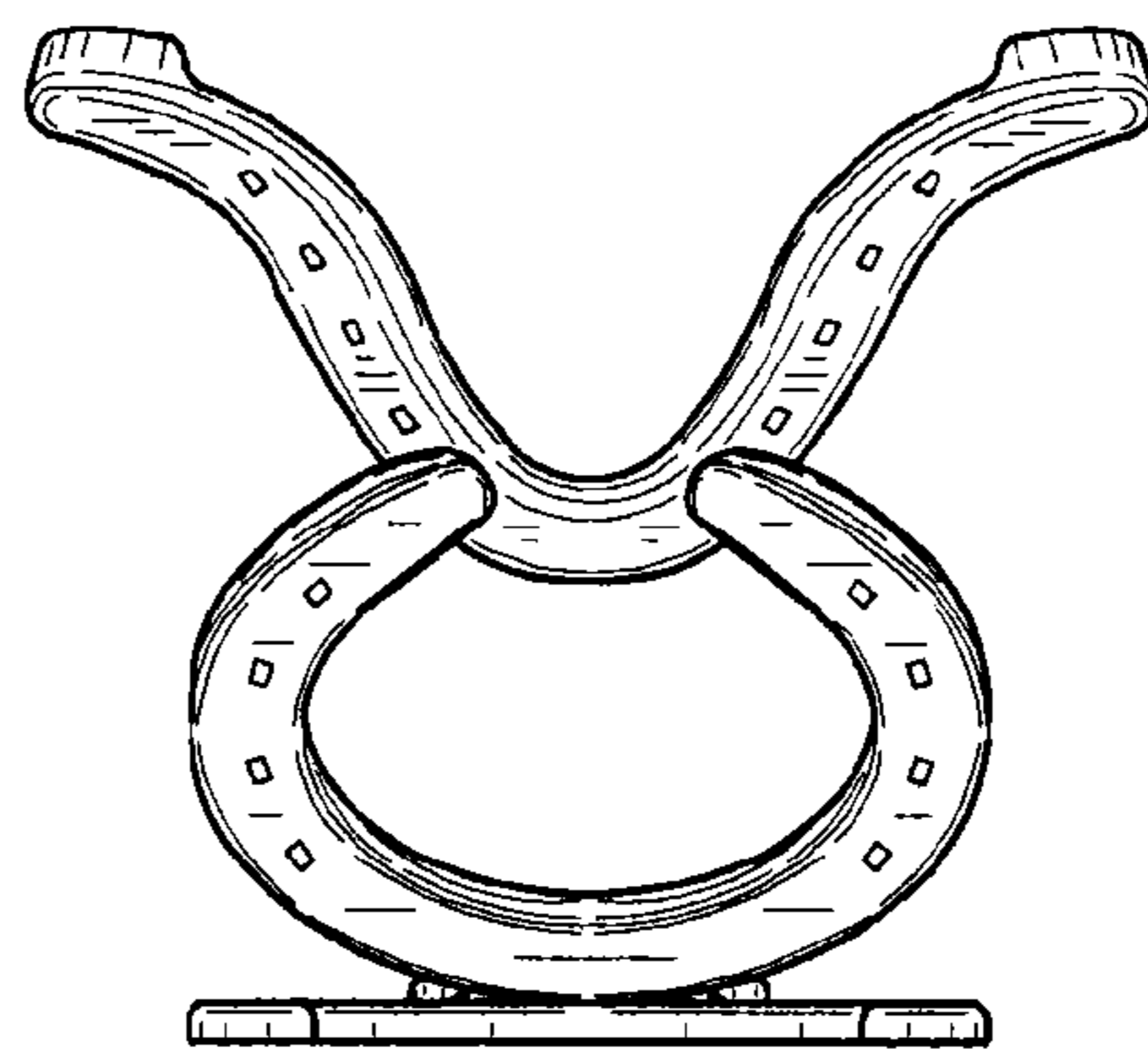

FIG. 3

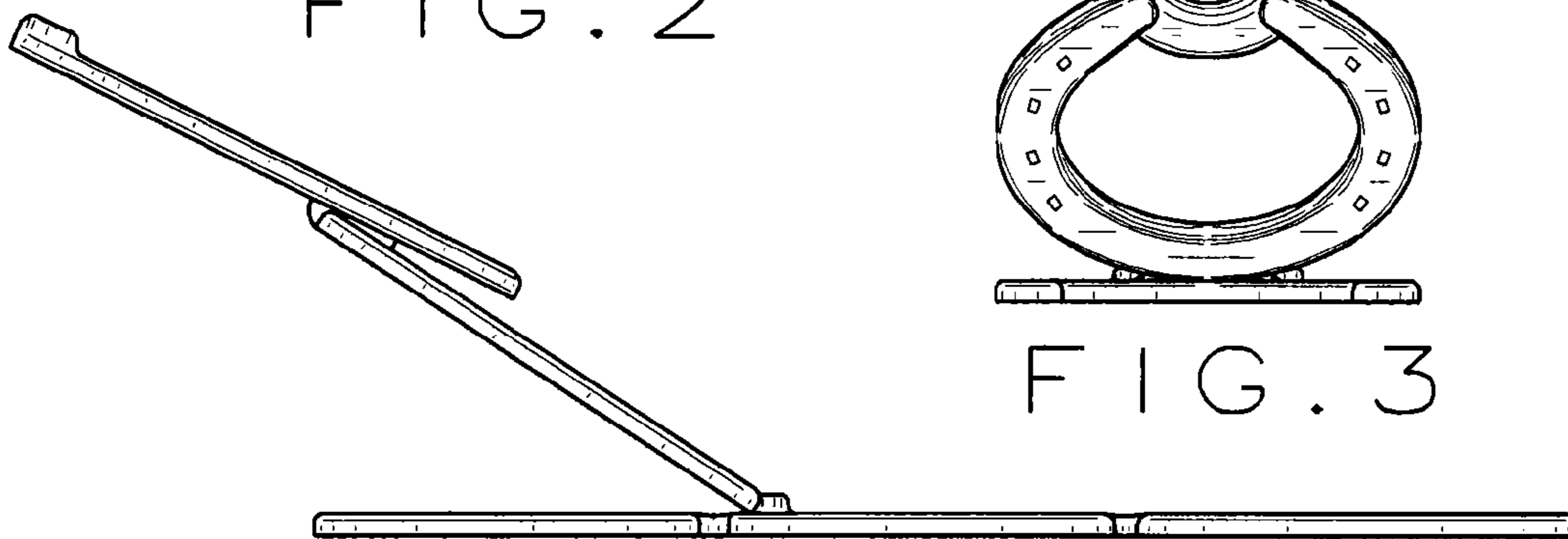

FIG. 4

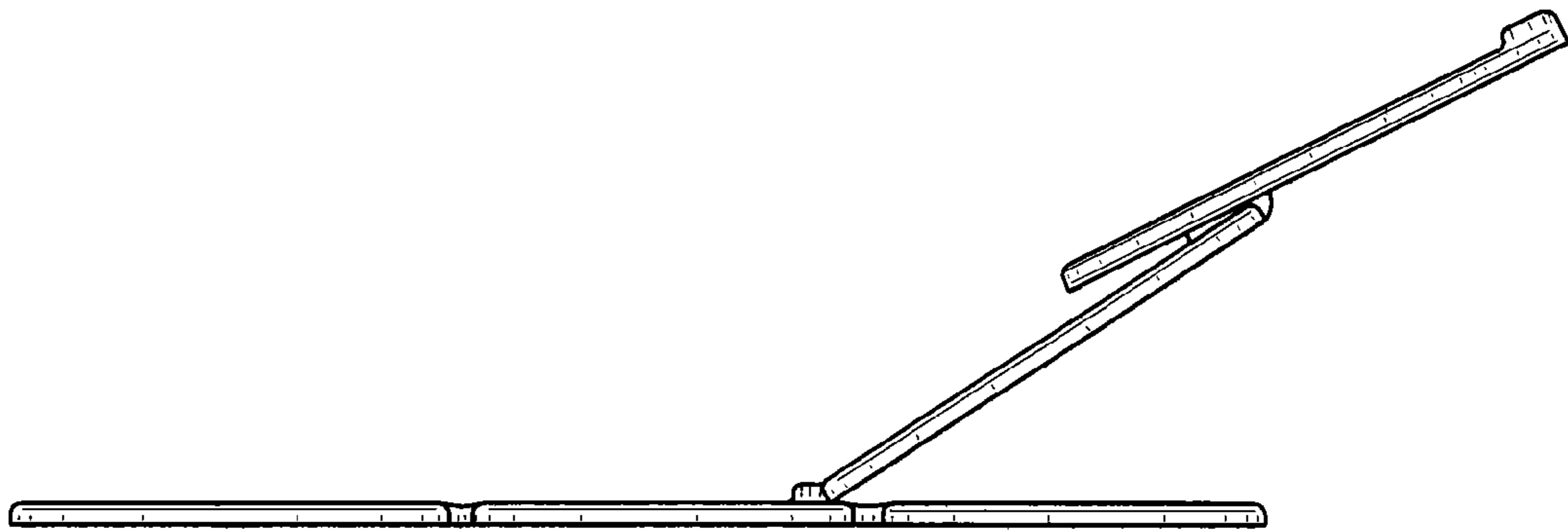

FIG. 5

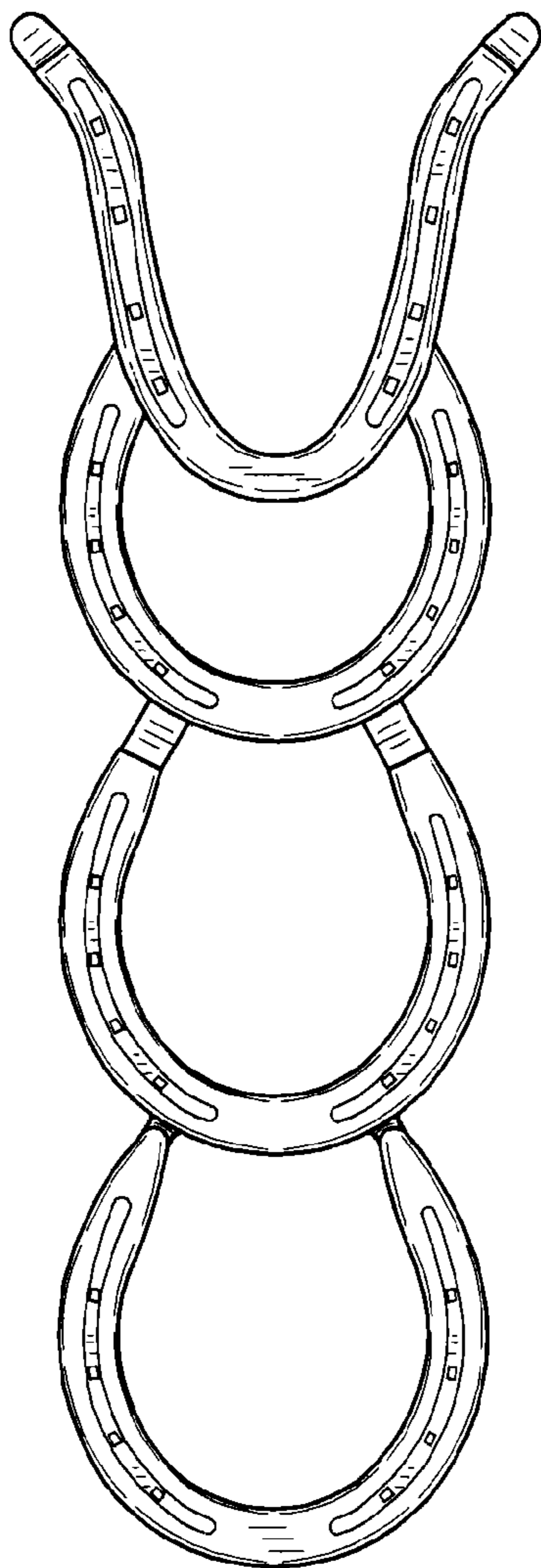

FIG. 6

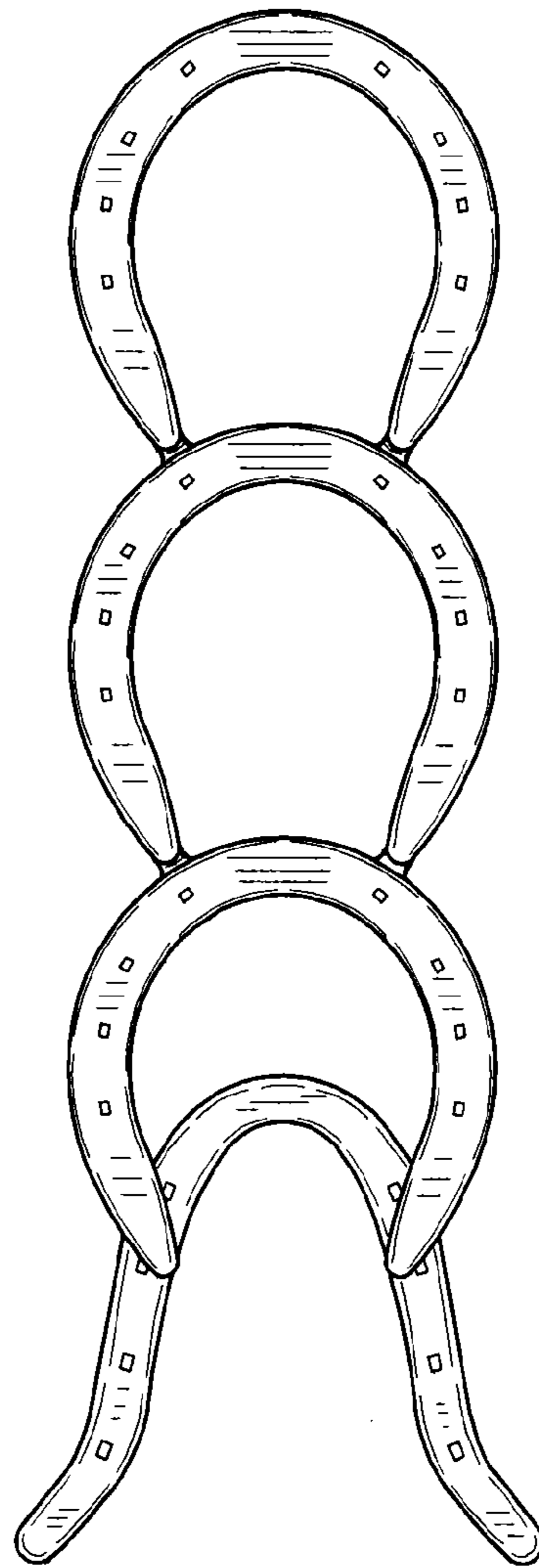

FIG. 7

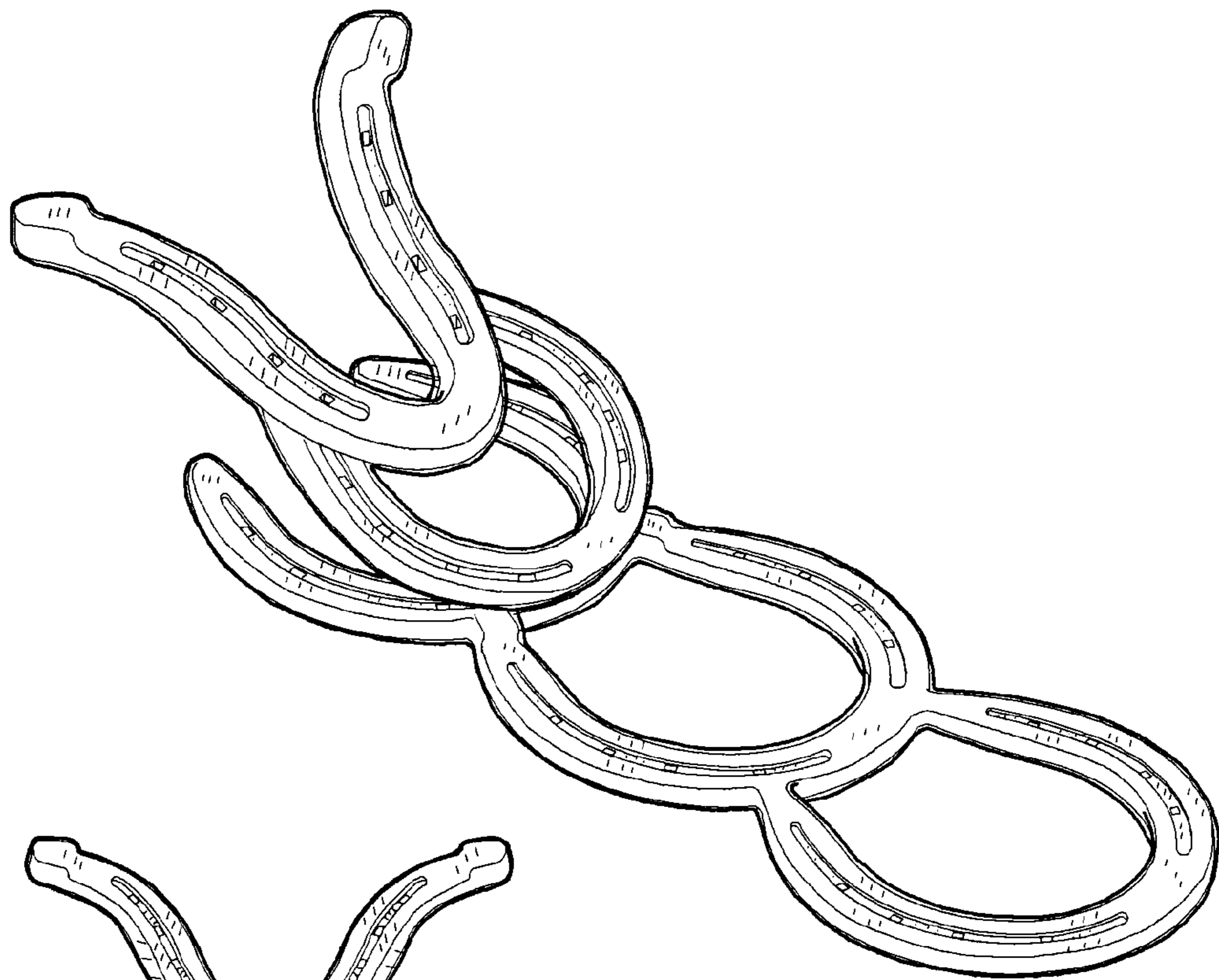

FIG. 8

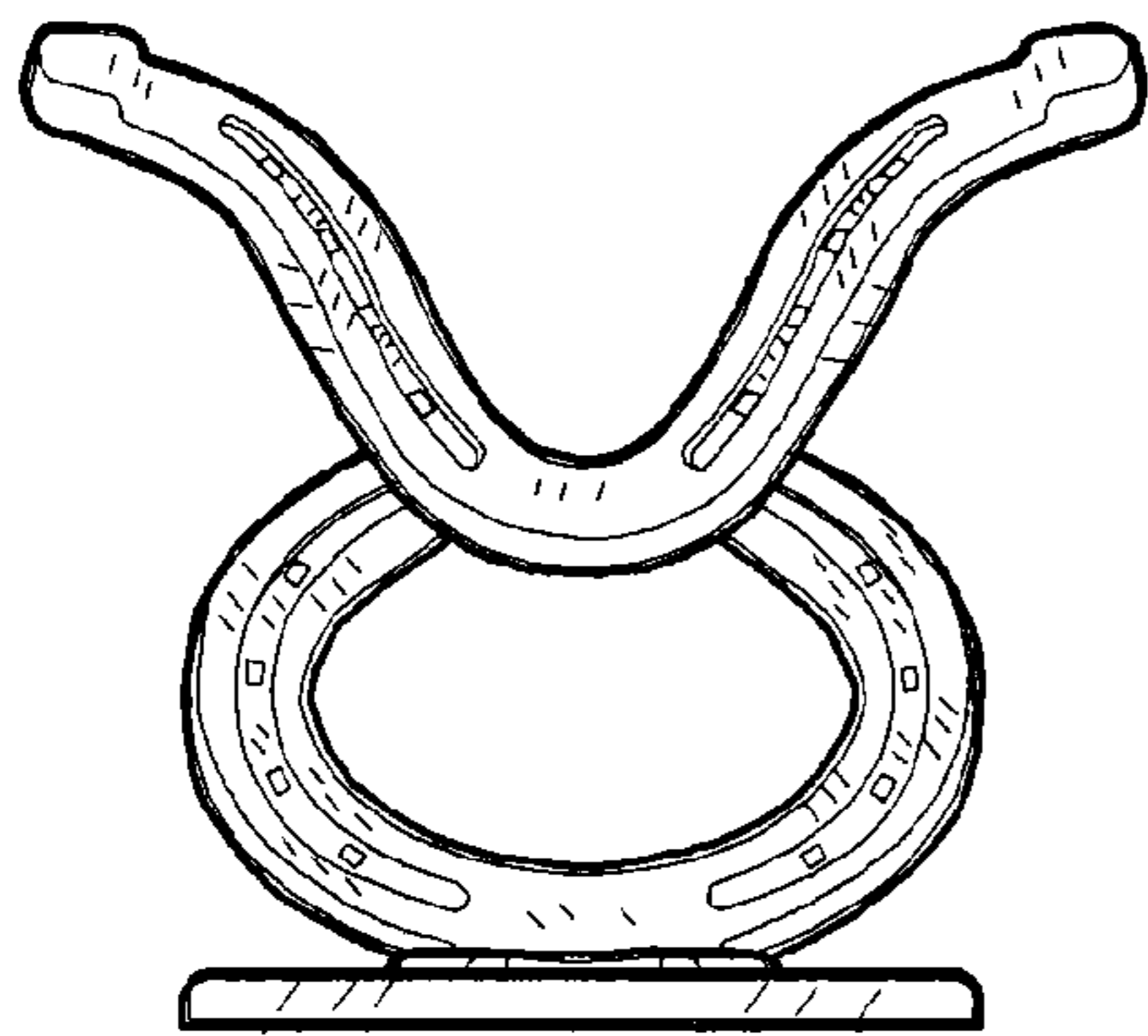

FIG. 9

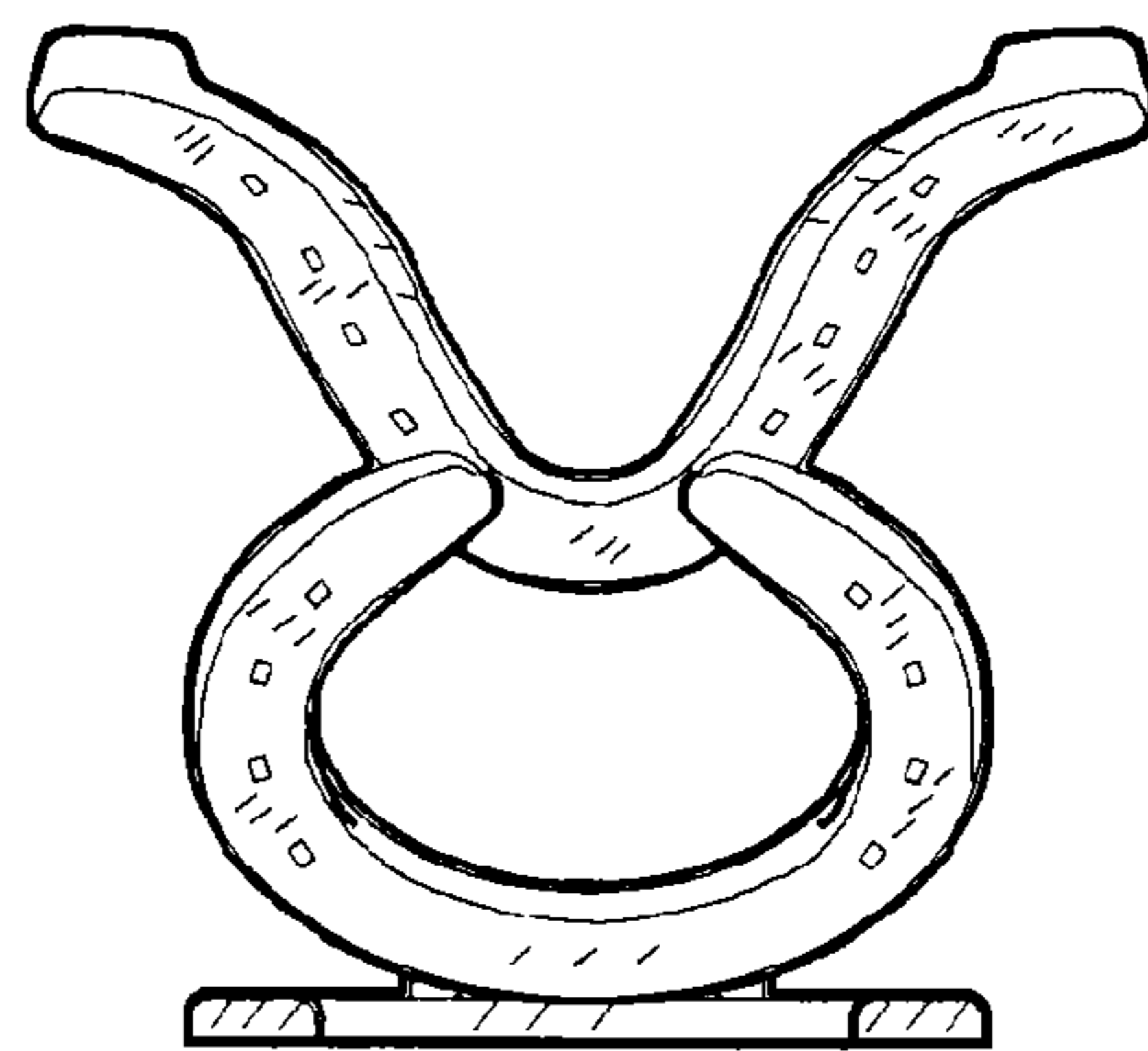

FIG. 10

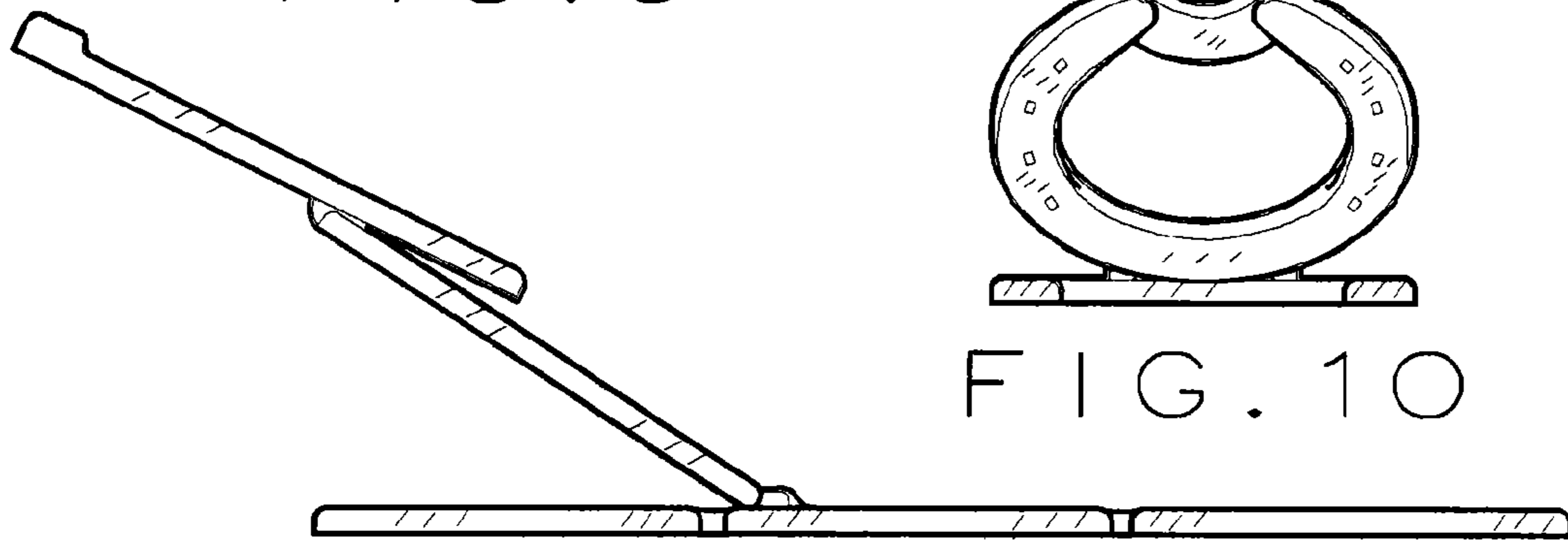

FIG. 11

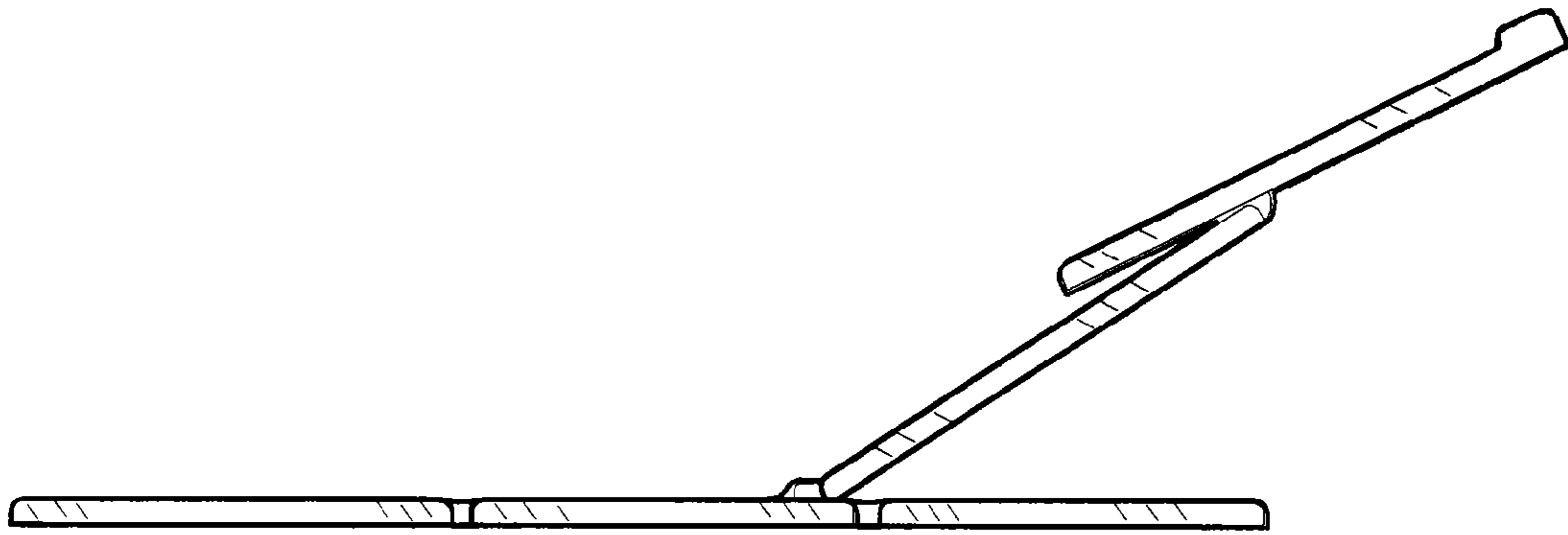

FIG. 12

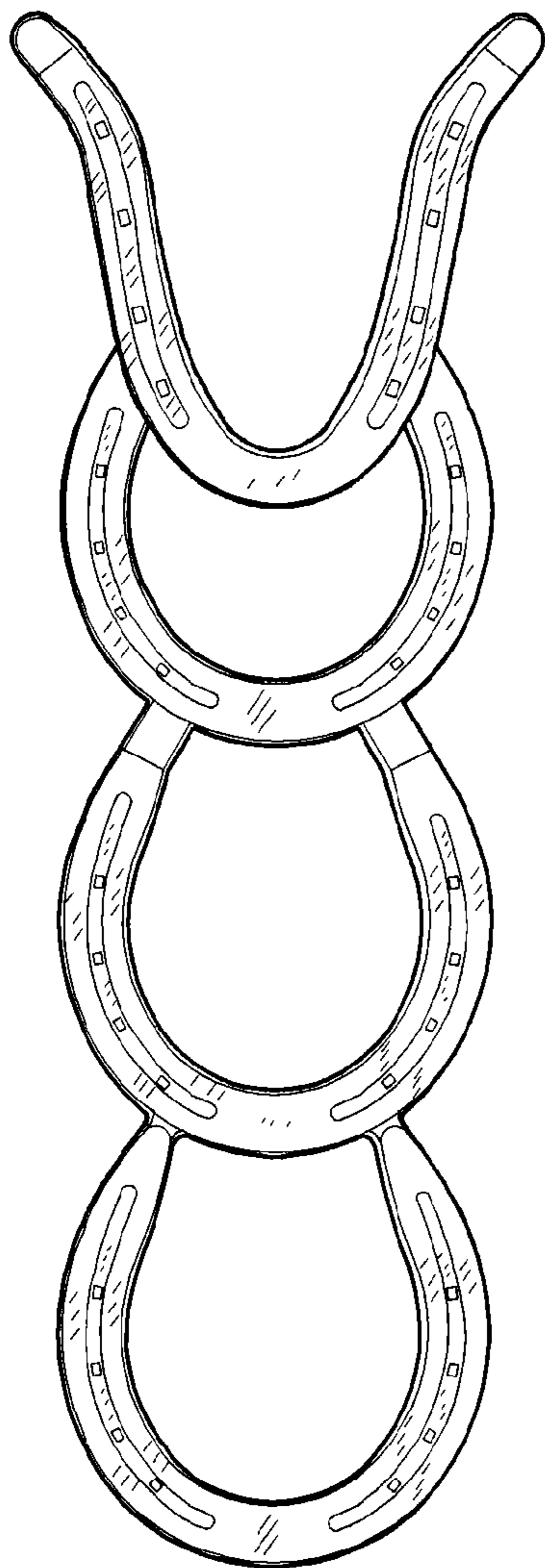

FIG. 13

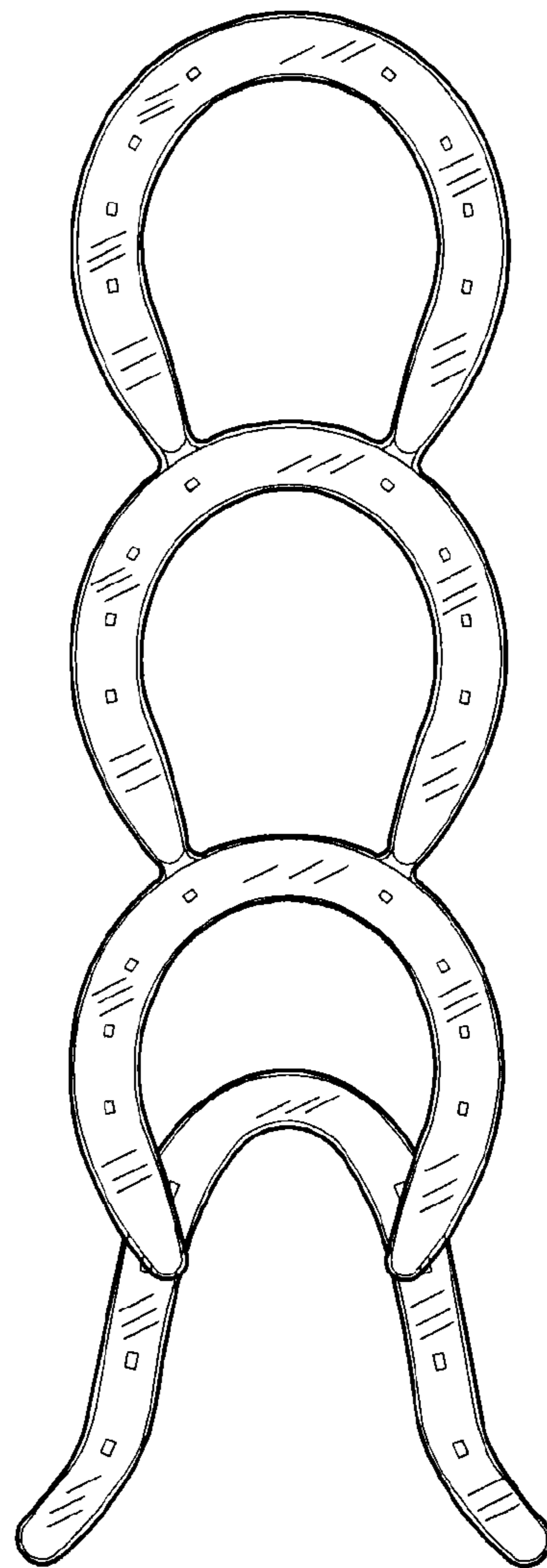

FIG. 14