



US00D645899S

(12) **United States Design Patent**
Nagano et al.

(10) **Patent No.:** **US D645,899 S**

(45) **Date of Patent:** **** Sep. 27, 2011**

(54) **PRINTER**

(75) Inventors: **Shuuji Nagano**, Kawasaki (JP); **Kanae Amemiya**, Tokyo (JP); **Satoshi Oda**, Yokohama (JP)

(73) Assignee: **Ricoh Company, Ltd.**, Tokyo (JP)

(**) Term: **14 Years**

(21) Appl. No.: **29/369,827**

(22) Filed: **Sep. 14, 2010**

(30) **Foreign Application Priority Data**

Mar. 17, 2010 (JP) 2010-006598

(51) **LOC (9) Cl.** **14-02**

(52) **U.S. Cl.** **D18/55**

(58) **Field of Classification Search** D18/19,
D18/36-37, 50, 54-54.1, 55; D14/420-425,
D14/463-470; 400/613, 613.1-613.4, 690,
400/690.1-690.4, 691-694

See application file for complete search history.

(56) **References Cited**

U.S. PATENT DOCUMENTS

D325,744 S * 4/1992 Tokuda D18/55
D343,414 S * 1/1994 Tokuda et al. D18/55
D379,196 S * 5/1997 Laidlaw D18/55
D402,688 S * 12/1998 Laidlaw D18/53

D402,698 S * 12/1998 Falk et al. D18/55
D412,341 S * 7/1999 Miyazawa D18/55
D443,891 S * 6/2001 Yonekawa et al.
D521,060 S * 5/2006 Katayama D18/55
D552,170 S * 10/2007 Kim et al. D18/55
D555,722 S * 11/2007 Bae et al. D18/55
D558,264 S * 12/2007 Smith et al. D18/55
D562,886 S * 2/2008 Egami et al. D18/55
D633,557 S * 3/2011 Egami et al. D18/55

* cited by examiner

Primary Examiner — Cathy A MacCormac

(74) *Attorney, Agent, or Firm* — Dickstein Shapiro LLP

(57) **CLAIM**

The ornamental design for printer, as shown and described.

DESCRIPTION

FIG. 1 is a top, front and right side perspective view of printer, showing the design;

FIG. 2 is a top, front and left side perspective view thereof;

FIG. 3 is a front view thereof;

FIG. 4 is a rear view thereof;

FIG. 5 is a right side view thereof;

FIG. 6 is a left side view thereof;

FIG. 7 is a top view thereof; and,

FIG. 8 is a bottom view thereof.

The broken lines are for illustration only and form no part of the claimed design.

1 Claim, 4 Drawing Sheets

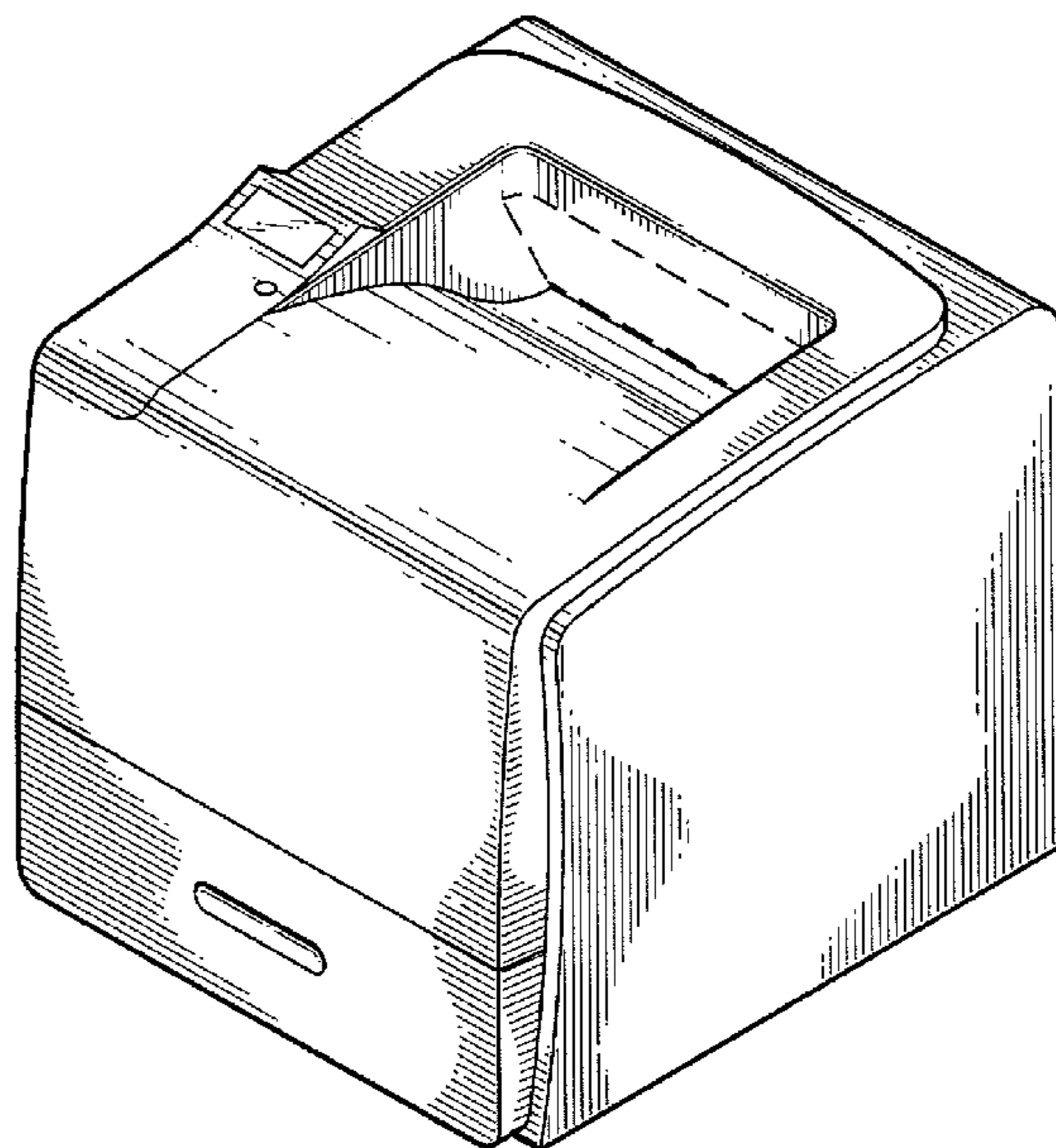
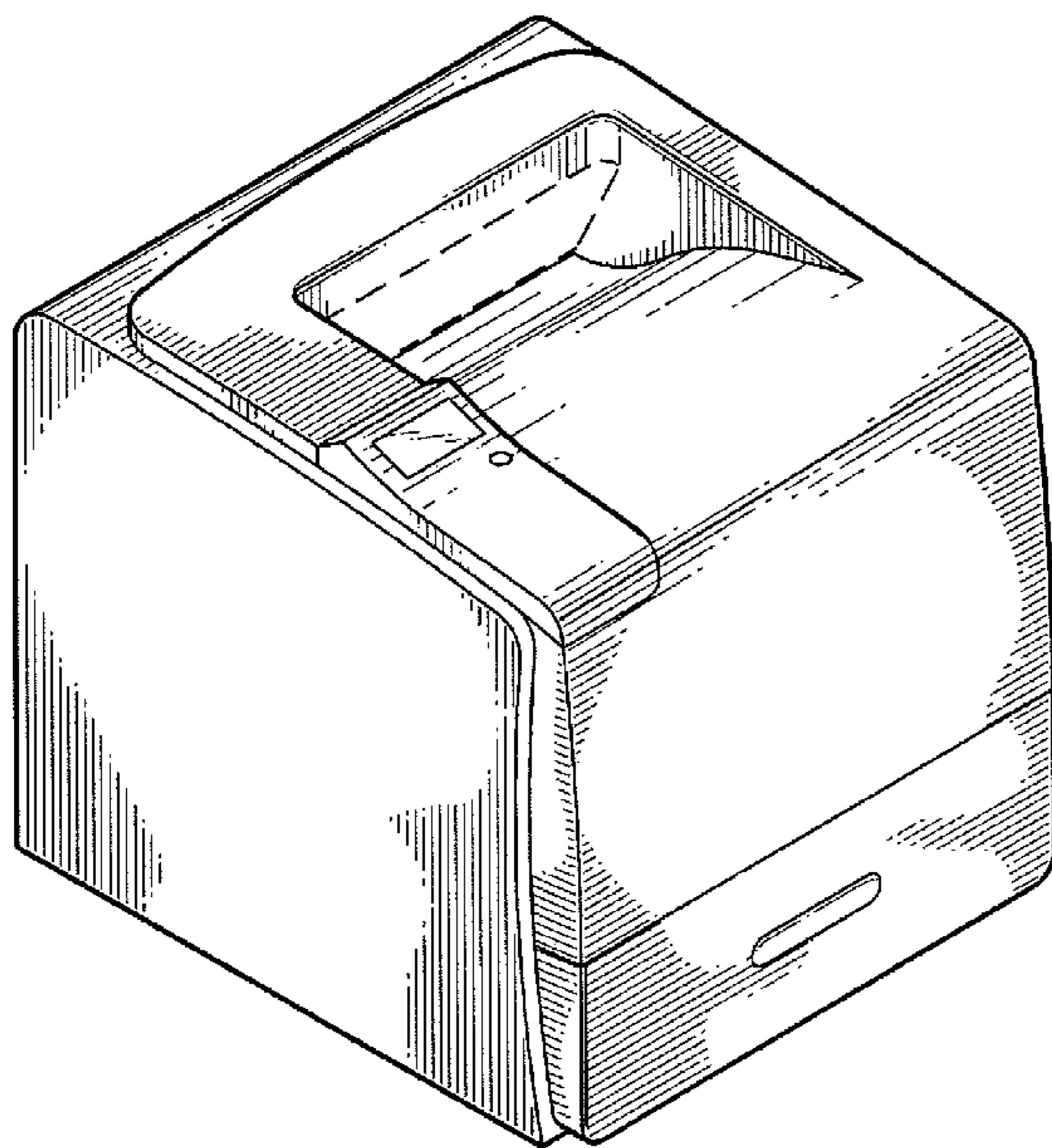

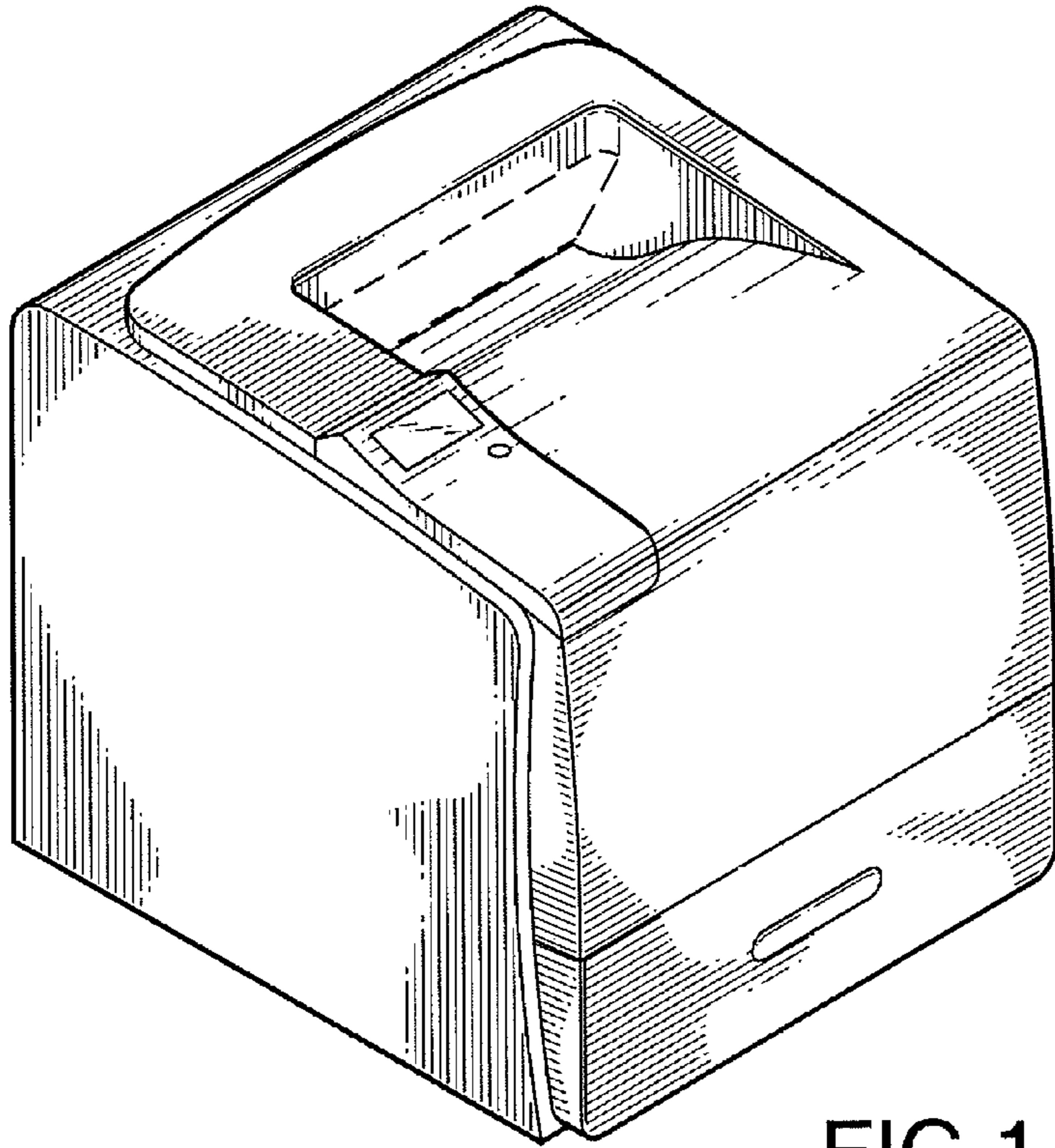

FIG. 1

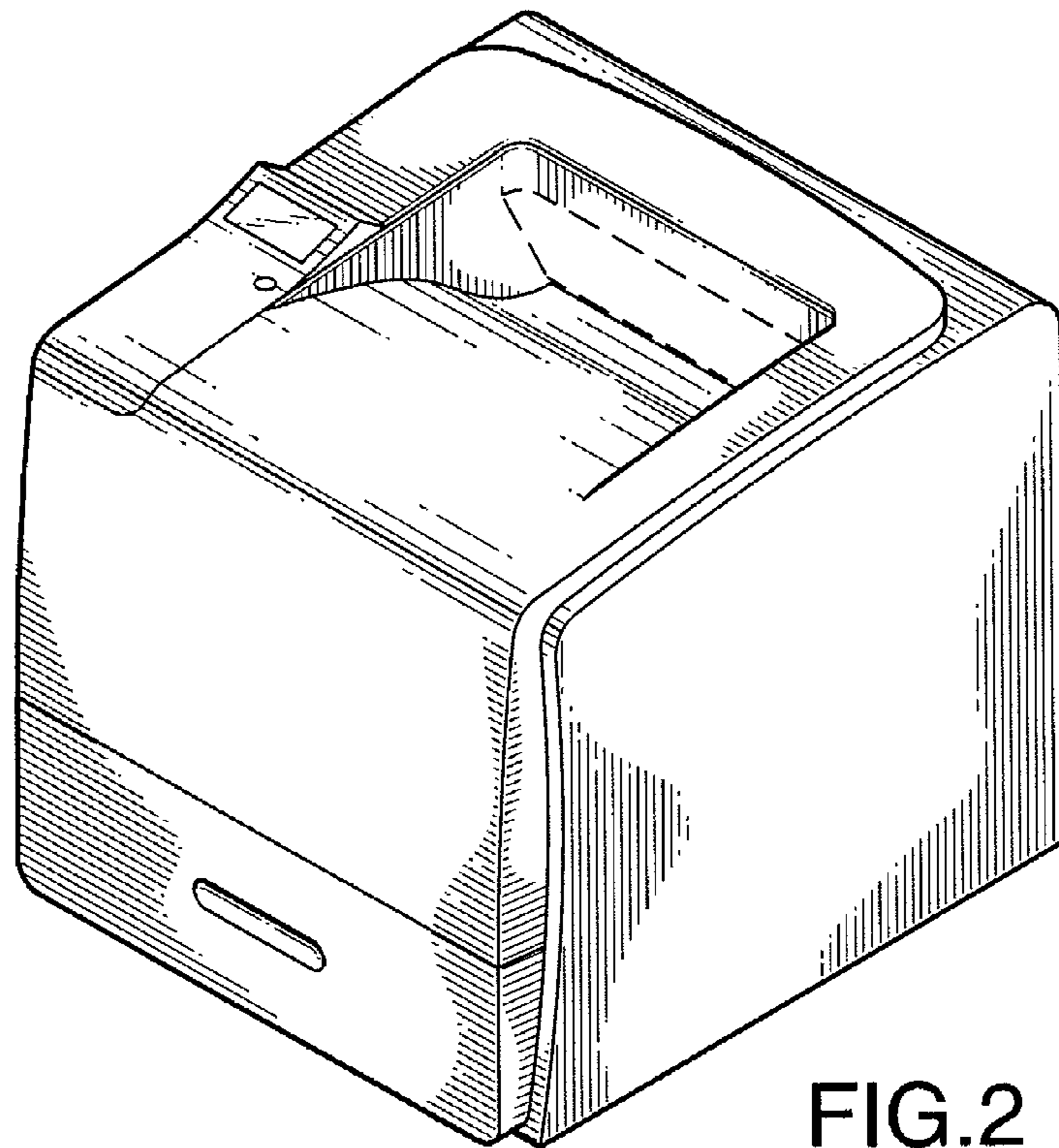

FIG. 2

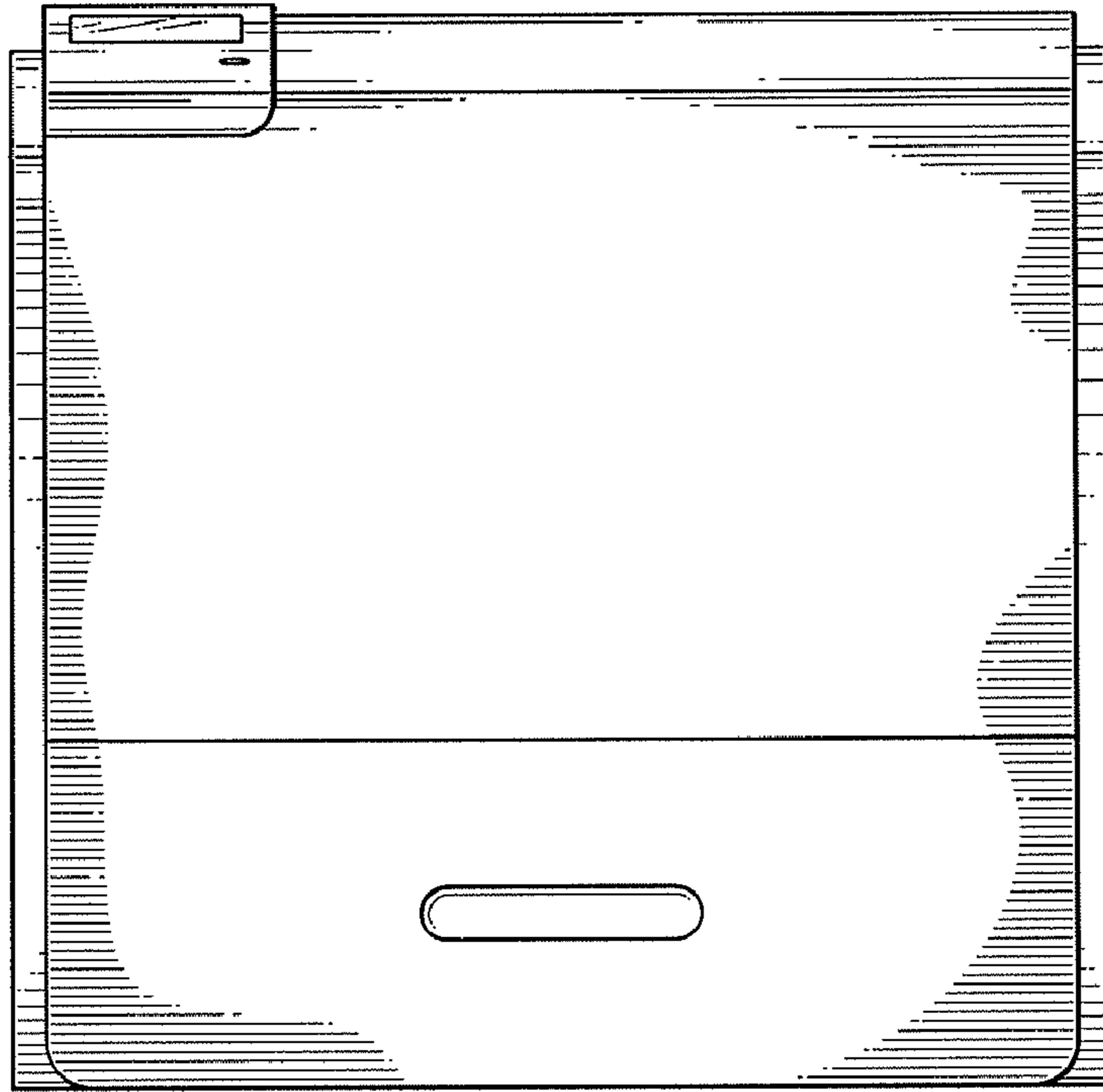

FIG.3

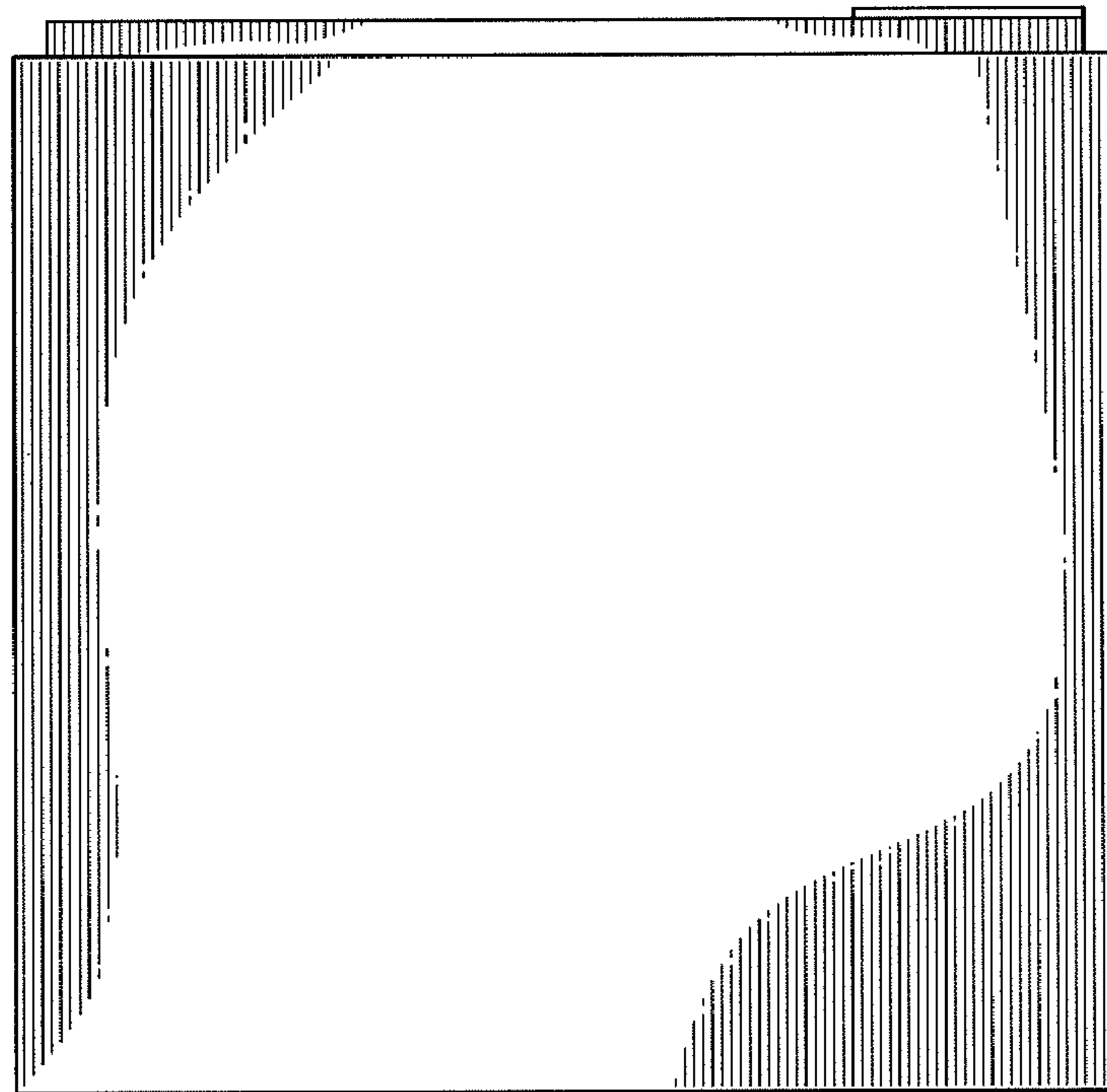

FIG.4

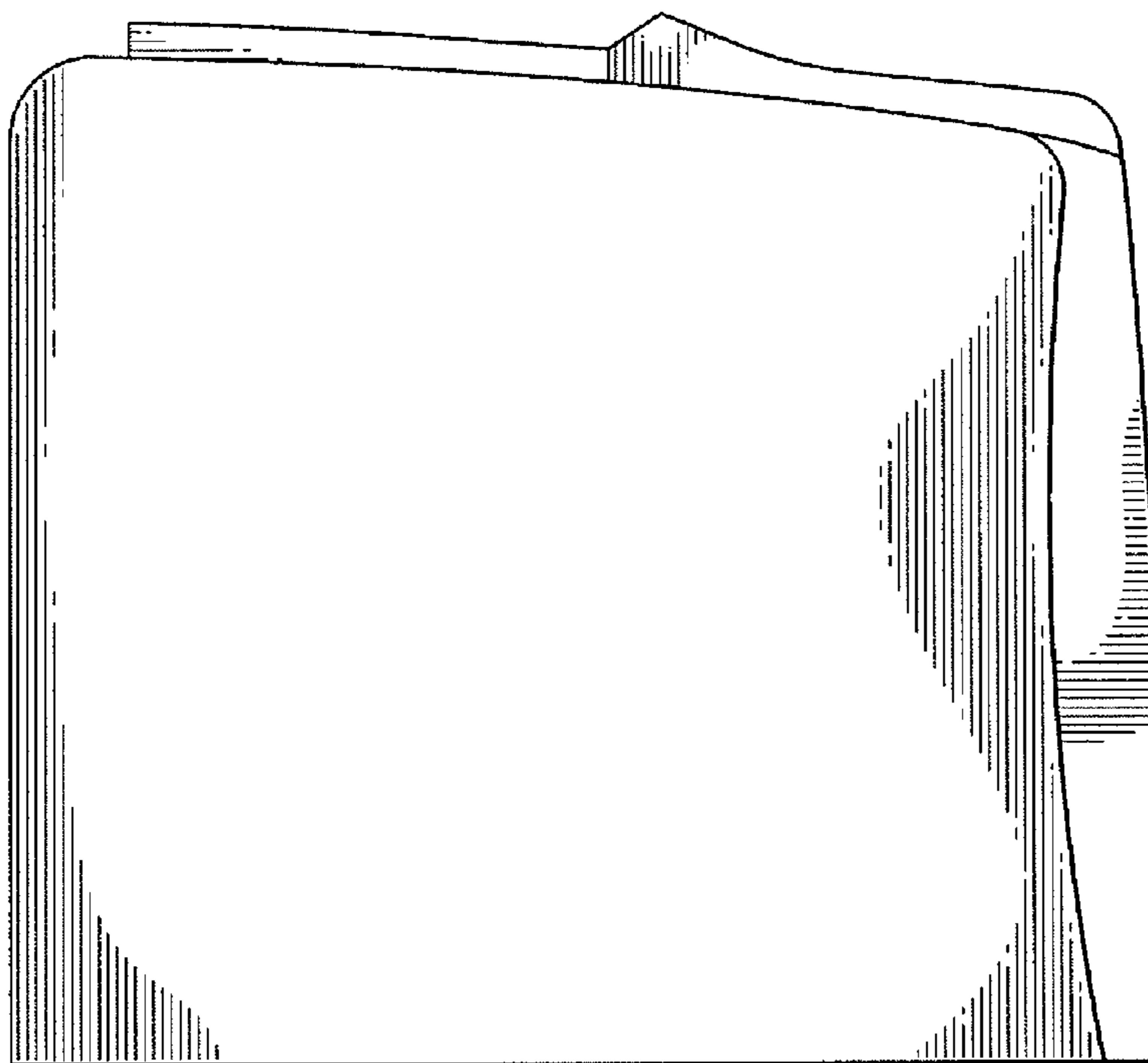

FIG. 5

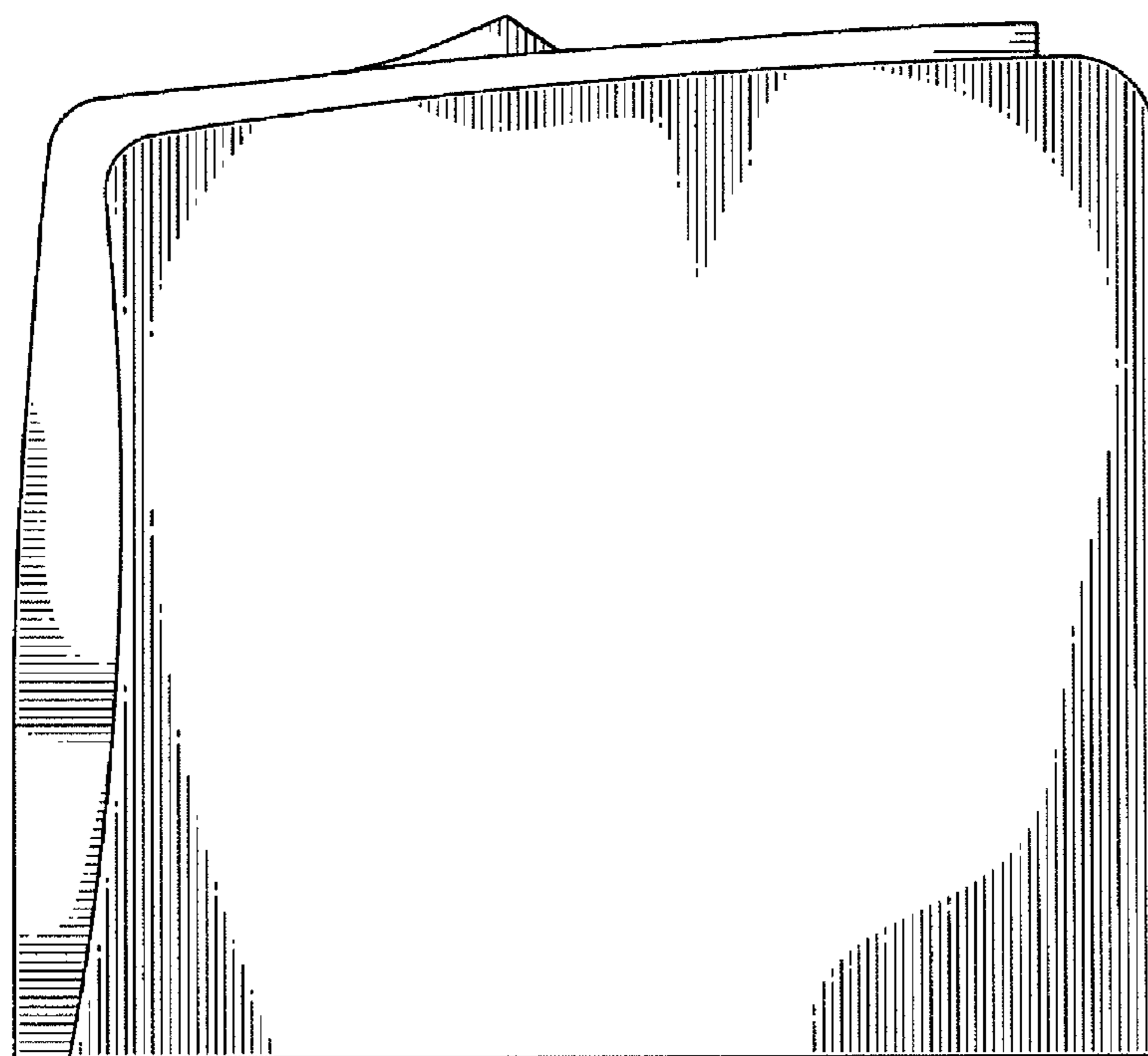

FIG. 6

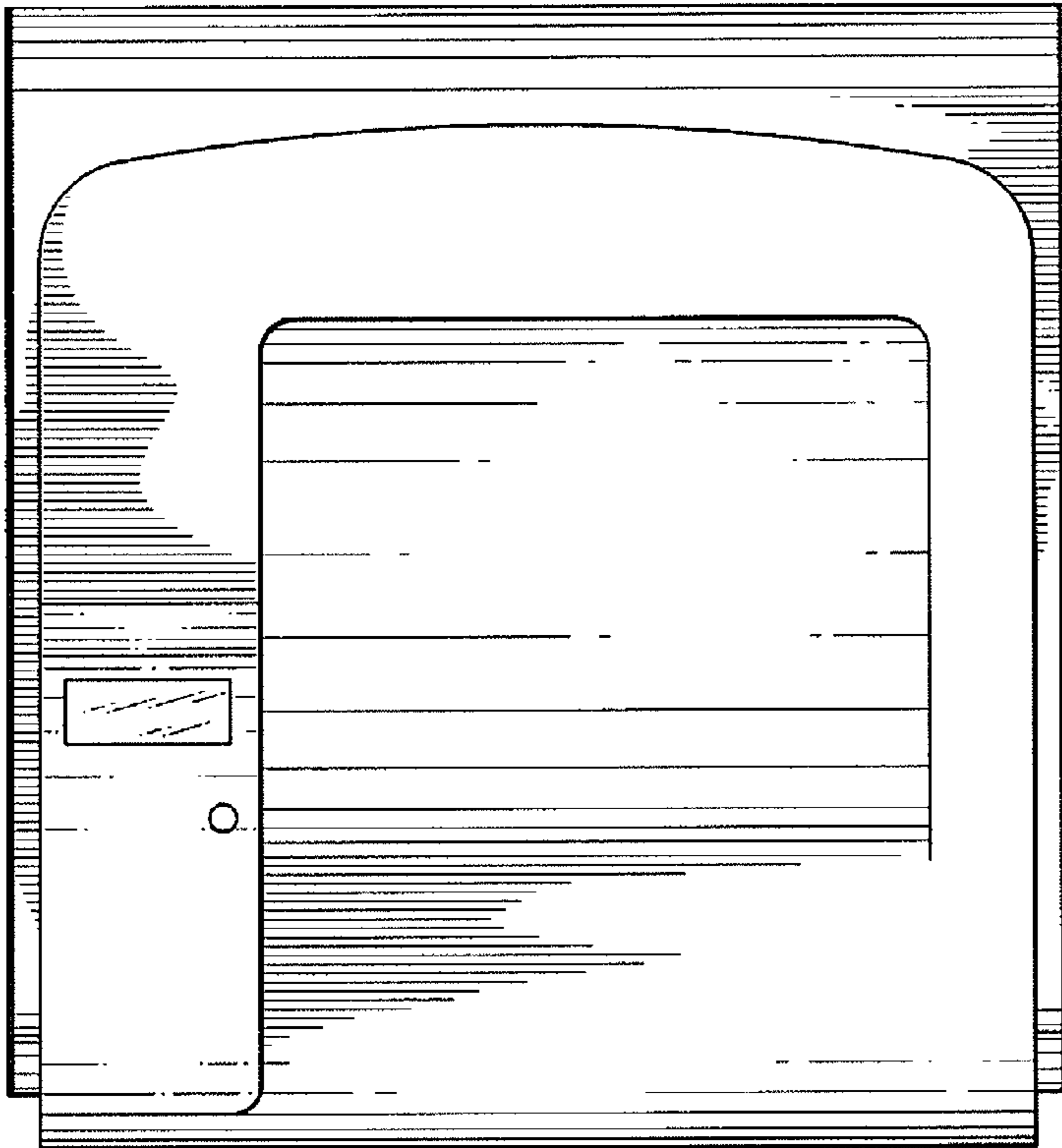

FIG.7



FIG.8