



US00D645836S

(12) **United States Design Patent**
Choi et al.

(10) **Patent No.:** **US D645,836 S**

(45) **Date of Patent:** **** Sep. 27, 2011**

(54) **MOBILE PHONE**

(75) Inventors: **Hyok-Su Choi**, Seoul (KR); **Seog-Guen Kim**, Seoul (KR)

(73) Assignee: **Samsung Electronics Co., Ltd.**, Suwon-Si (KR)

(**) Term: **14 Years**

(21) Appl. No.: **29/381,316**

(22) Filed: **Dec. 17, 2010**

(30) **Foreign Application Priority Data**

Oct. 12, 2010 (KR) 30-2010-0044275

(51) **LOC (9) Cl.** **14-03**

(52) **U.S. Cl.** **D14/138 AD; D14/138 G**

(58) **Field of Classification Search** D14/138 R,
D14/138 AD, 138 AC, 138 C, 138 G, 191,
D14/203.1–203.8, 496, 138 AA, 138 AB,
D14/137, 147, 218, 341–347, 247–248; D10/65,
D10/78, 104; D13/168; D18/7; 455/566,
455/575.1, 575.3, 575.4
See application file for complete search history.

(56) **References Cited**

U.S. PATENT DOCUMENTS

D526,302 S *	8/2006	Kim	D14/138 AD
D537,064 S *	2/2007	Kim et al.	D14/138 AA
D554,635 S *	11/2007	Chung et al.	D14/341
D558,719 S *	1/2008	Choi et al.	D14/138 AA
D558,720 S *	1/2008	Lee et al.	D14/138 AD
D562,292 S *	2/2008	Park	D14/138 AD
D563,371 S *	3/2008	Kim et al.	D14/138 AA
D602,460 S *	10/2009	Kim et al.	D14/138 AD
D603,363 S *	11/2009	Choi et al.	D14/138 AB
D611,023 S *	3/2010	Wu et al.	D14/138 G
D615,946 S *	5/2010	Mun	D14/138 G
D618,651 S *	6/2010	Lee et al.	D14/138 AD
D618,655 S *	6/2010	Sandberg	D14/138 G

D619,989 S *	7/2010	Huang	D14/138 G
D619,991 S *	7/2010	Huang	D14/138 G
D620,054 S *	7/2010	Yano	D21/329
D621,378 S *	8/2010	Kim et al.	D14/138 AD
D626,526 S *	11/2010	Lee et al.	D14/138 AD
D633,066 S *	2/2011	Park et al.	D14/138 AD
D635,562 S *	4/2011	Fan et al.	D14/248
2003/0125094 A1 *	7/2003	Hyun et al.	455/566
2007/0191078 A1 *	8/2007	Kim	455/575.4
2008/0004085 A1 *	1/2008	Jung et al.	455/566
2008/0132288 A1 *	6/2008	Misawa	455/566
2009/0117944 A1 *	5/2009	Lee et al.	455/566

OTHER PUBLICATIONS

LG GT505, announced Jun. 2009, [online], [retrieved on Jun. 12, 2009]. Retrieved from Internet ,<URL: <http://www.gsmarena.com>>.*

LG GT400 Viewty Smile, announced Apr. 2010, [online], [retrieved on Jun. 11, 2010]. Retrieved from Internet ,<URL: <http://www.gsmarena.com>>.*

(Continued)

Primary Examiner — Bridget L Eland

(74) *Attorney, Agent, or Firm* — Staas & Halsey LLP

(57) **CLAIM**

The ornamental design for a mobile phone, as shown and described.

DESCRIPTION

FIG. 1 is a front perspective view of a mobile phone; FIG. 2 is a front view of the mobile phone of FIG. 1; FIG. 3 is a rear view of the mobile phone of FIG. 1; FIG. 4 is a left-side view of the mobile phone of FIG. 1; FIG. 5 is a right-side view of the mobile phone of FIG. 1; FIG. 6 is a top plan view of the mobile phone of FIG. 1; FIG. 7 is a bottom plan view of the mobile phone of FIG. 1; and, FIG. 8 is an open front sideways perspective view of the mobile phone of FIG. 1.

1 Claim, 8 Drawing Sheets

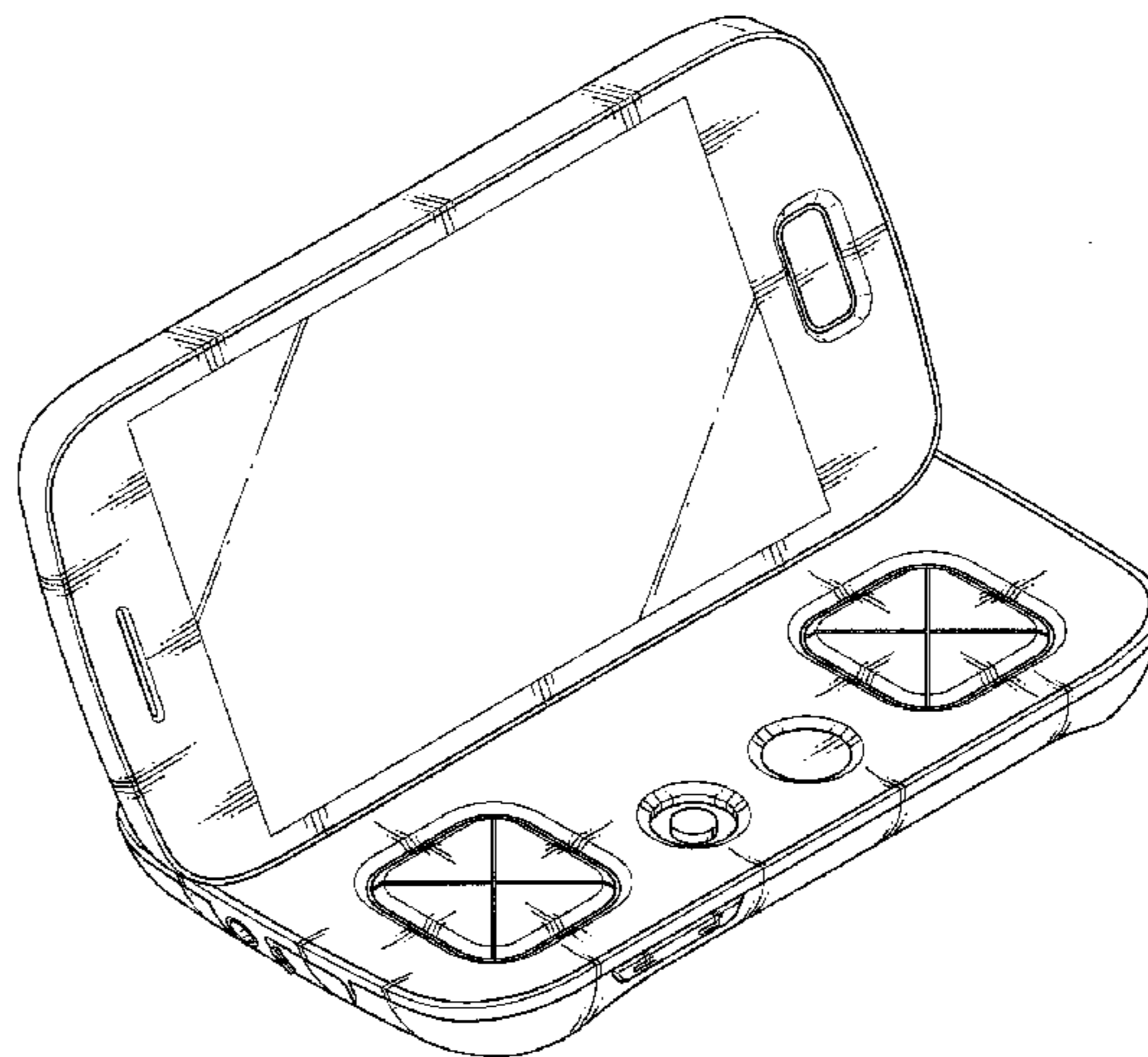
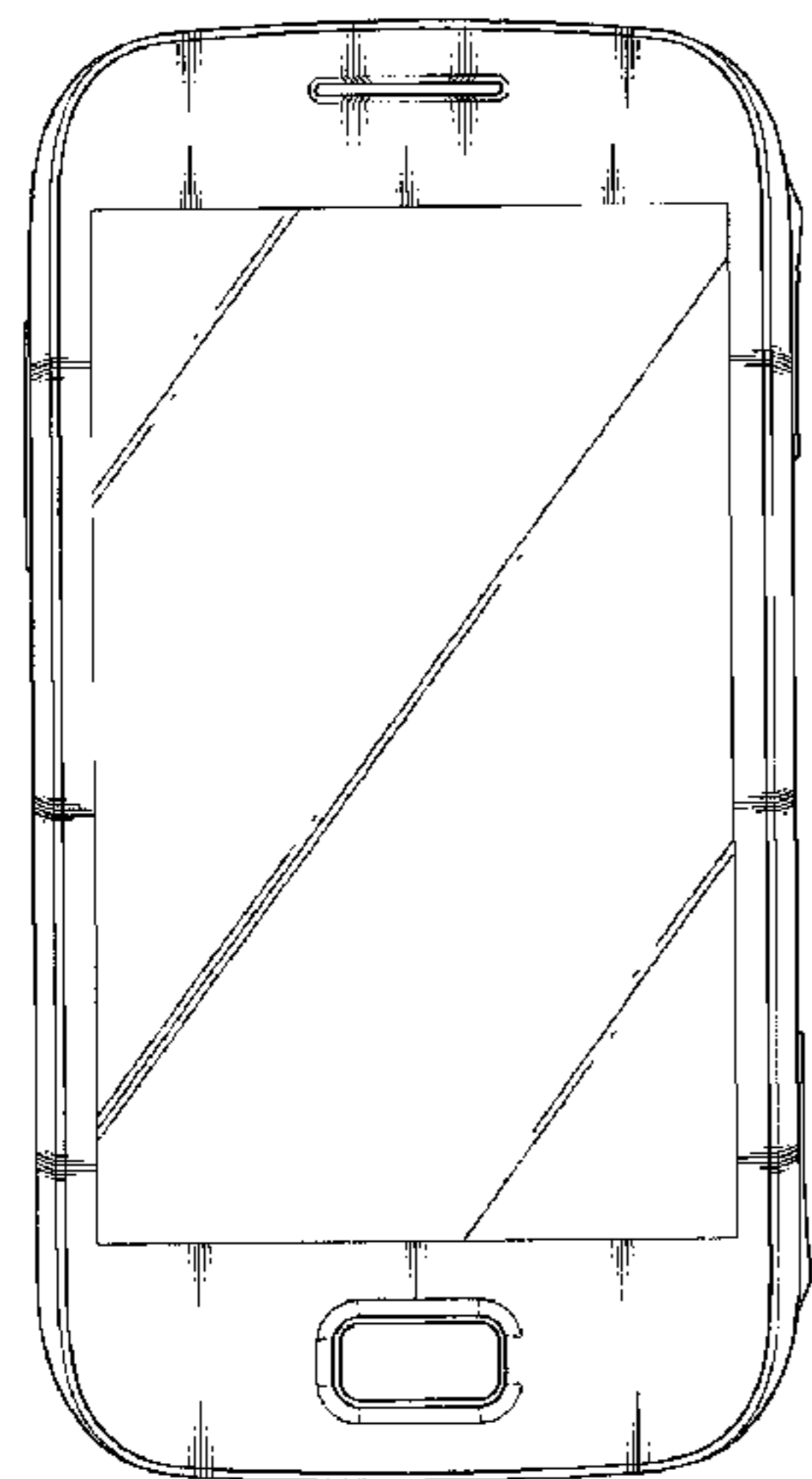

OTHER PUBLICATIONS

Samsung Galaxy Ace S5830, announced Jan. 2011, [online], [retrieved on Feb. 17, 2011]. Retrieved from Internet ,<URL: <http://www.gsmarena.com>>.*

Samsung I9000 Galaxy S, announced Mar. 2010, [online], [retrieved on Apr. 6, 2010]. Retrieved from Internet ,<URL: <http://www.gsmarena.com>>.*

* cited by examiner

FIG.1

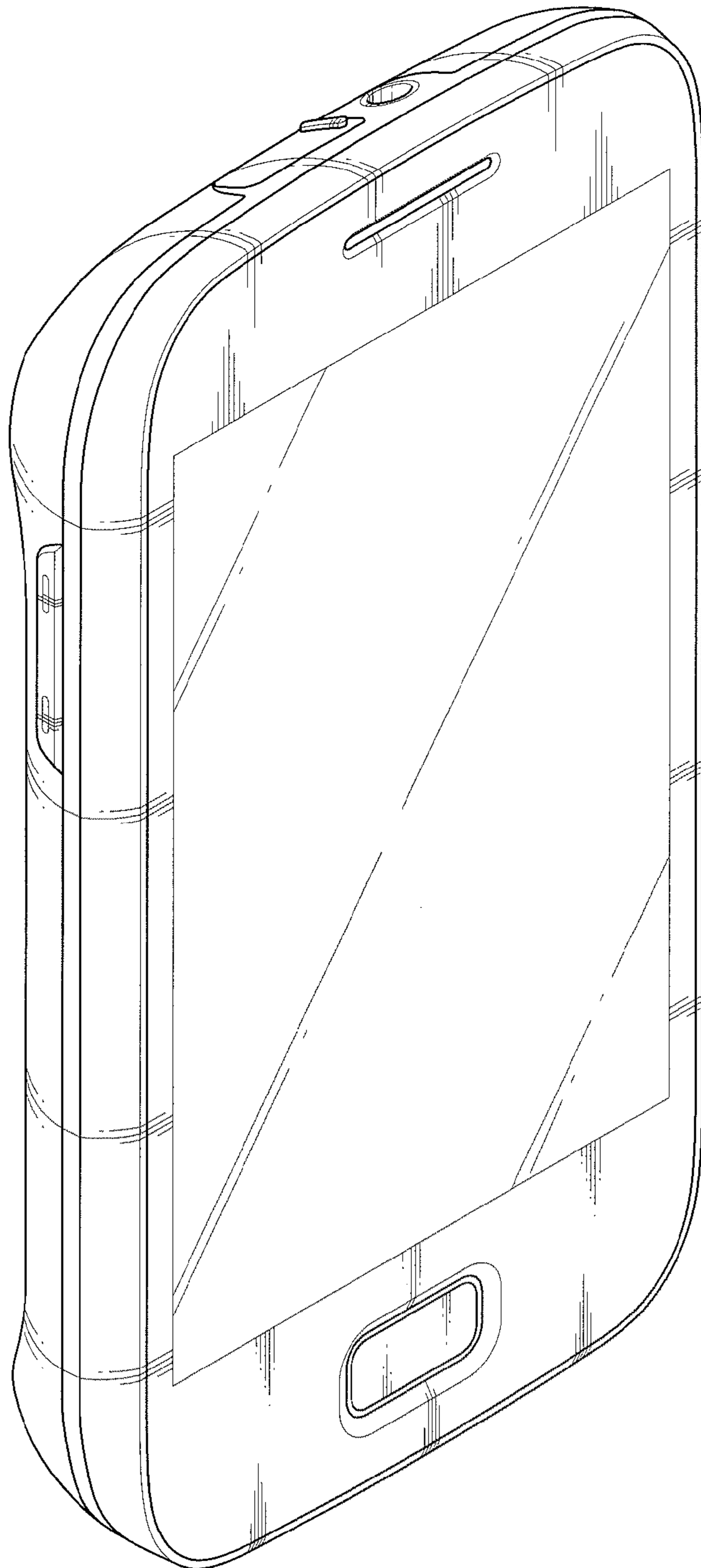

FIG.2

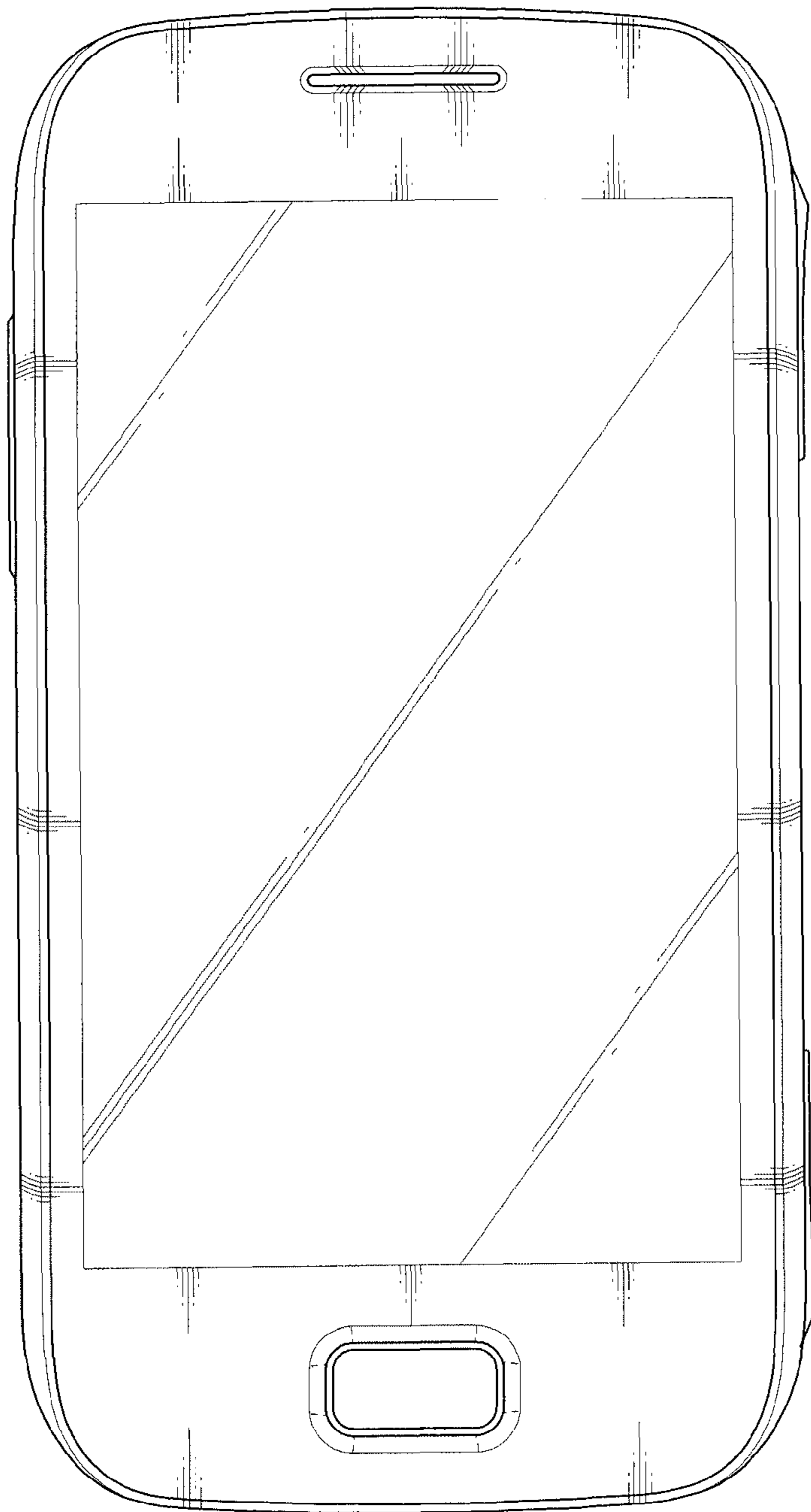

FIG.3

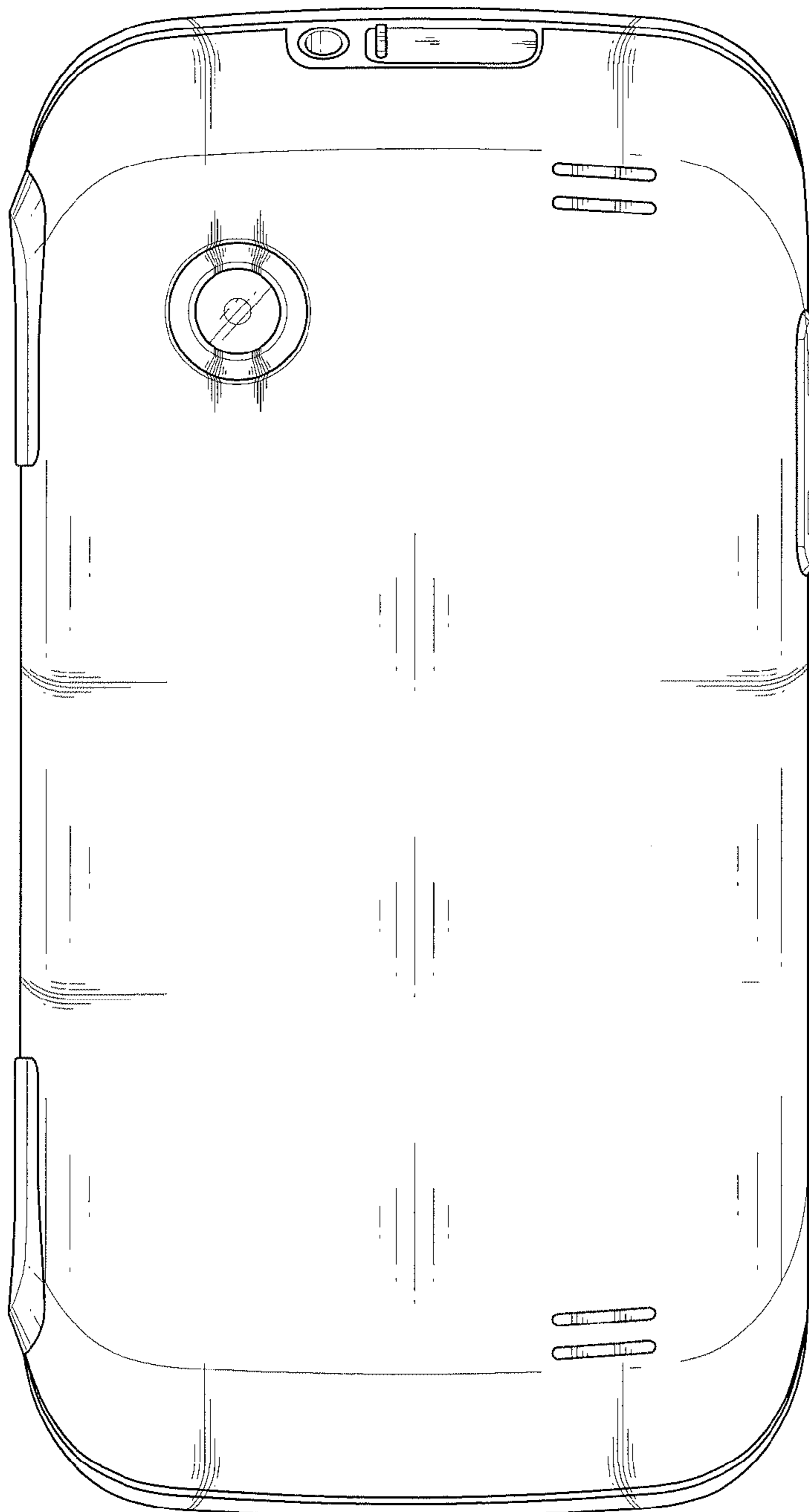

FIG.4

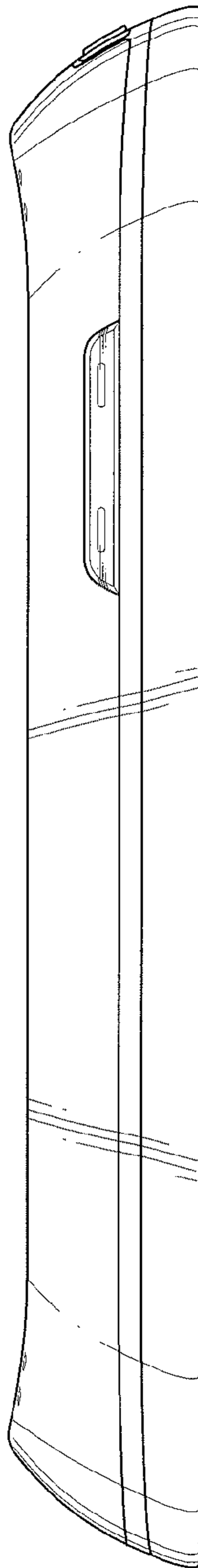

FIG. 5

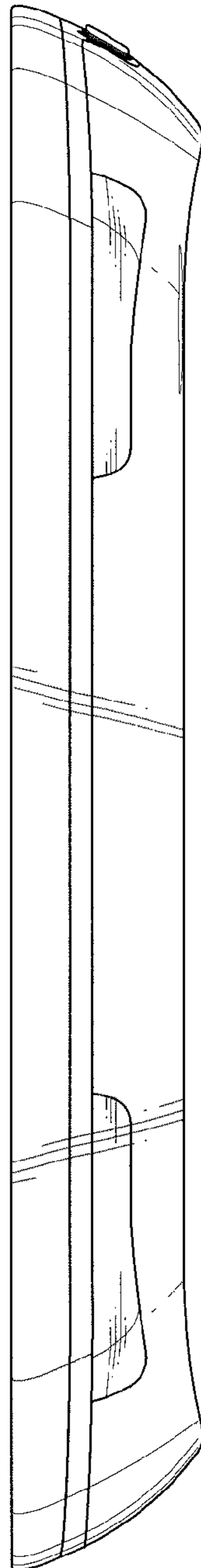

FIG.6

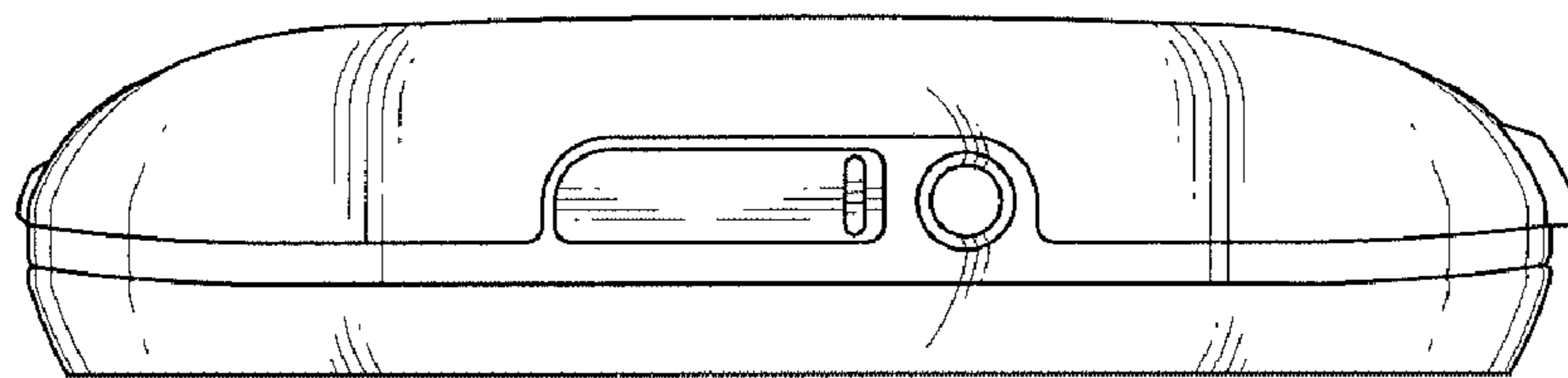

FIG.7

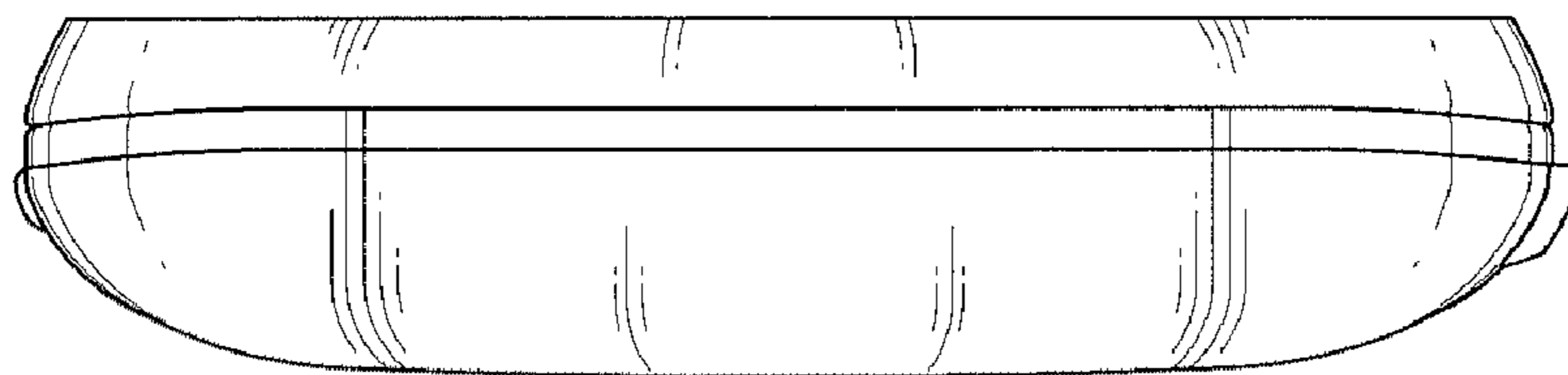

FIG.8

