



US00D645828S

(12) **United States Design Patent**
Su

(10) **Patent No.:** **US D645,828 S**

(45) **Date of Patent:** **** Sep. 27, 2011**

(54) **TANK ACTUATION PANEL**

(75) Inventor: **Sophie Su**, Shanghai (CN)

(73) Assignee: **Kohler (China) Investment Co., Ltd.**,
Shanghai (CN)

(**) Term: **14 Years**

(21) Appl. No.: **29/356,494**

(22) Filed: **Feb. 26, 2010**

(30) **Foreign Application Priority Data**

Aug. 27, 2009 (CN) 2009 3 0100990

(51) **LOC (9) Cl.** **13-03**

(52) **U.S. Cl.** **D13/174**

(58) **Field of Classification Search** D13/169,
D13/170, 171, 174; 200/553, 252, 293, 296,
200/329, 333, 339

See application file for complete search history.

(56) **References Cited**

U.S. PATENT DOCUMENTS

D204,941 S * 5/1966 Ramsing et al. D13/169
D216,395 S * 12/1969 Gallup D13/169
4,669,804 A * 6/1987 Munroe 439/398
4,914,265 A * 4/1990 Mongeau 200/330

5,738,206 A * 4/1998 Souza 200/43.16
D534,875 S * 1/2007 Wu D13/169
D538,235 S * 3/2007 Fabrizi D13/158
7,488,909 B2 * 2/2009 Kajiwara et al. 200/310
7,579,566 B2 * 8/2009 Sloan et al. 200/331
2008/0302647 A1 * 12/2008 Villain et al. 200/343
2010/0147666 A1 * 6/2010 Laurent et al. 200/341

* cited by examiner

Primary Examiner — Selina Sikder

(74) *Attorney, Agent, or Firm* — Foley & Lardner LLP

(57) **CLAIM**

The ornamental design for a tank actuation panel, as shown and described.

DESCRIPTION

FIG. 1 is a perspective view of the tank actuation panel embodying new design;

FIG. 2 is a top plan view thereof;

FIG. 3 is a front elevational view thereof;

FIG. 4 is a rear elevational view thereof;

FIG. 5 is a left side elevational thereof; and,

FIG. 6 is a right side elevational view thereof.

The broken line showing of the tank actuation panel is for the purpose of illustrating environmental structure and forms no part of the claimed design.

1 Claim, 4 Drawing Sheets

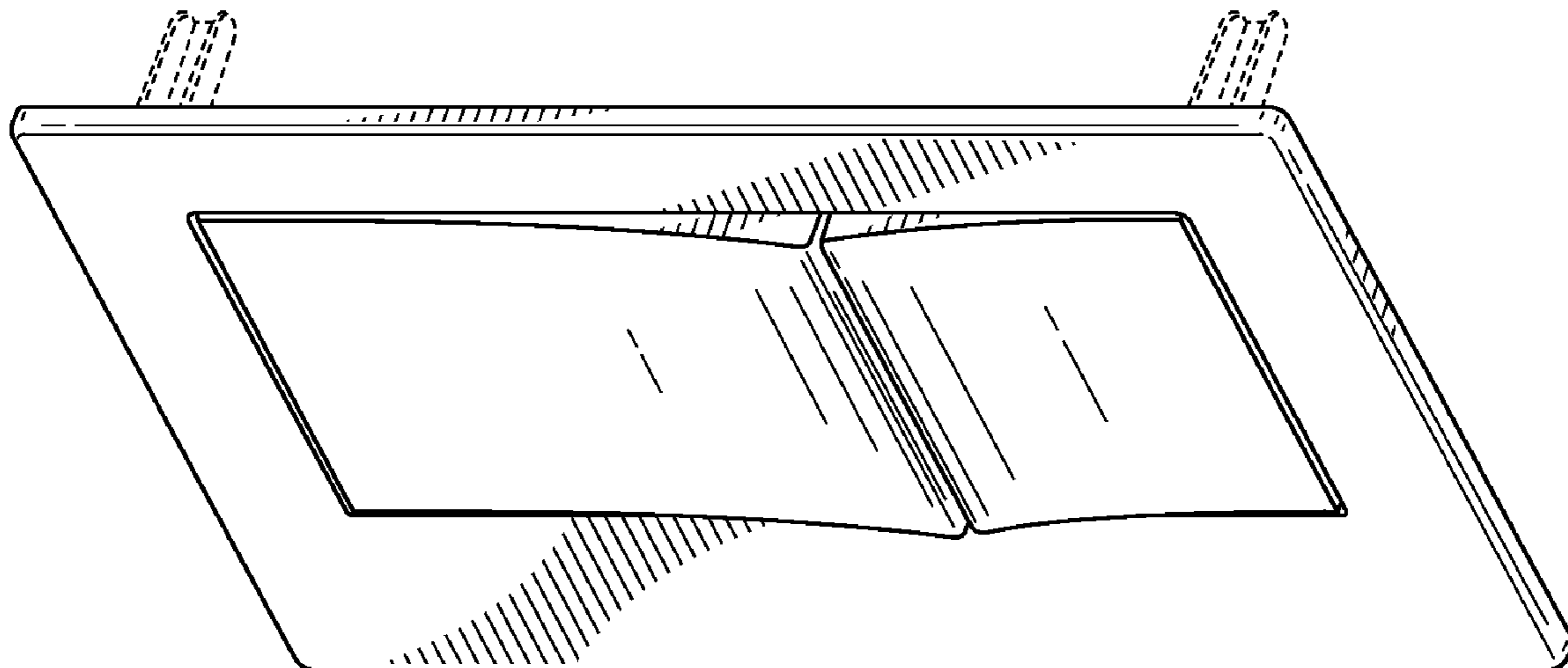

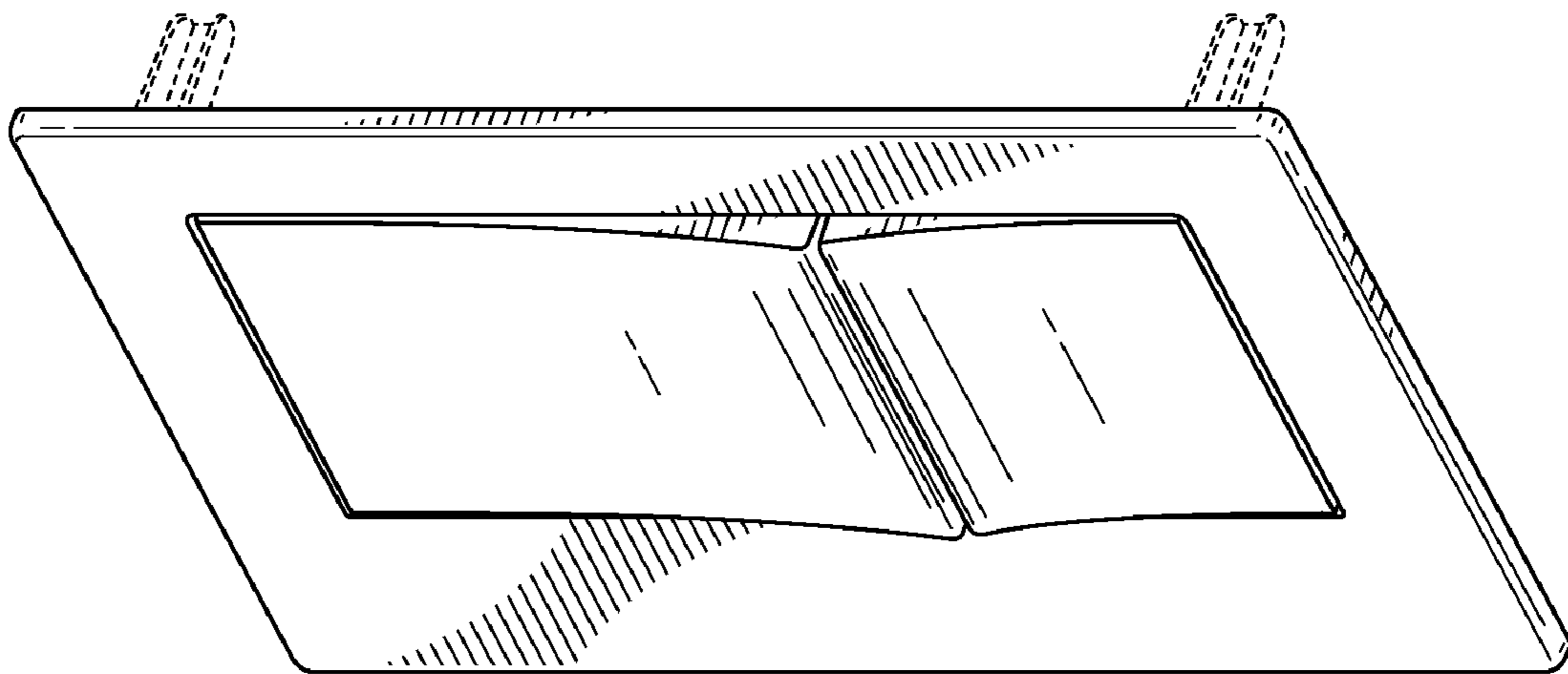

FIG. 1

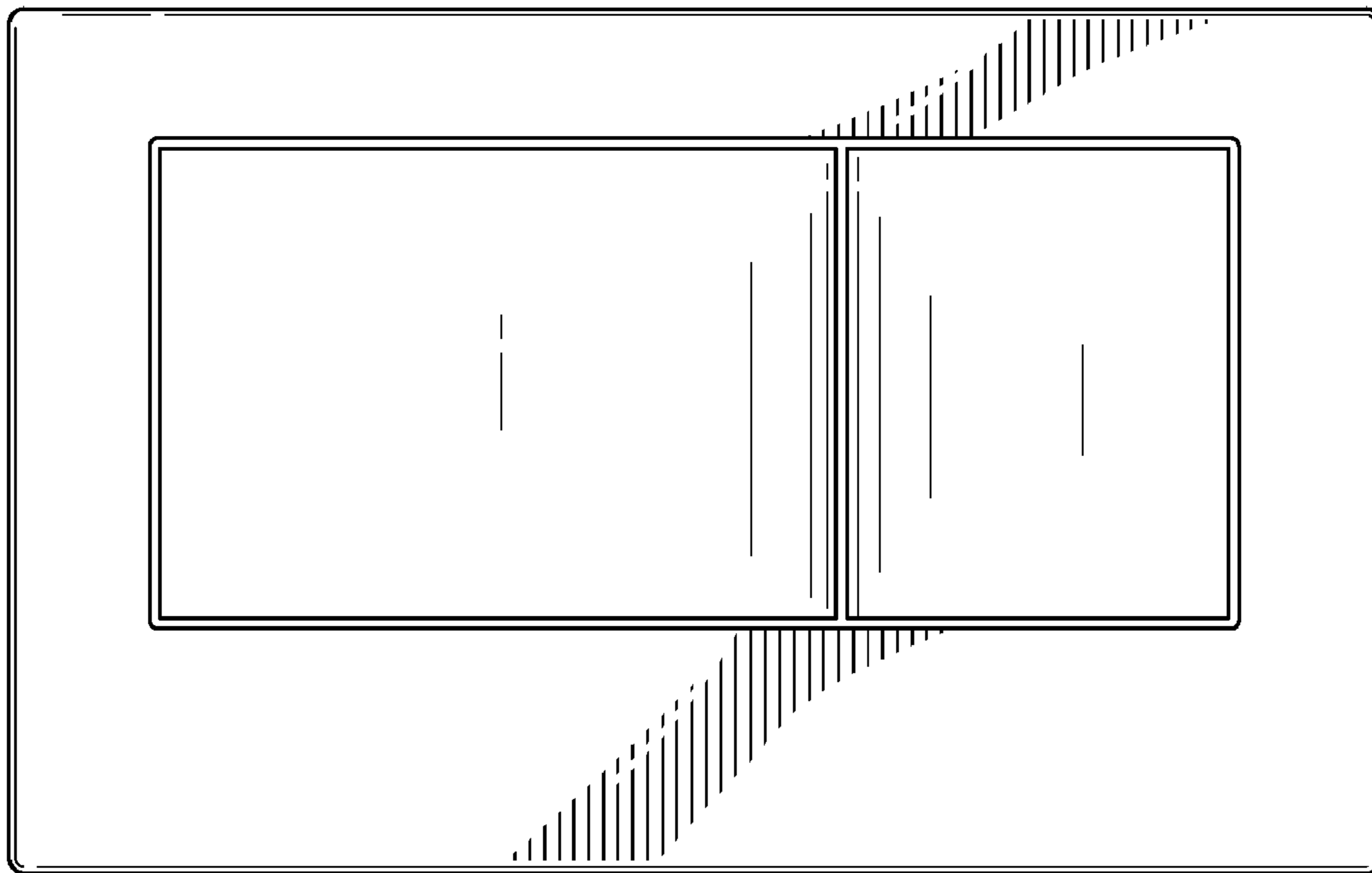

FIG. 2

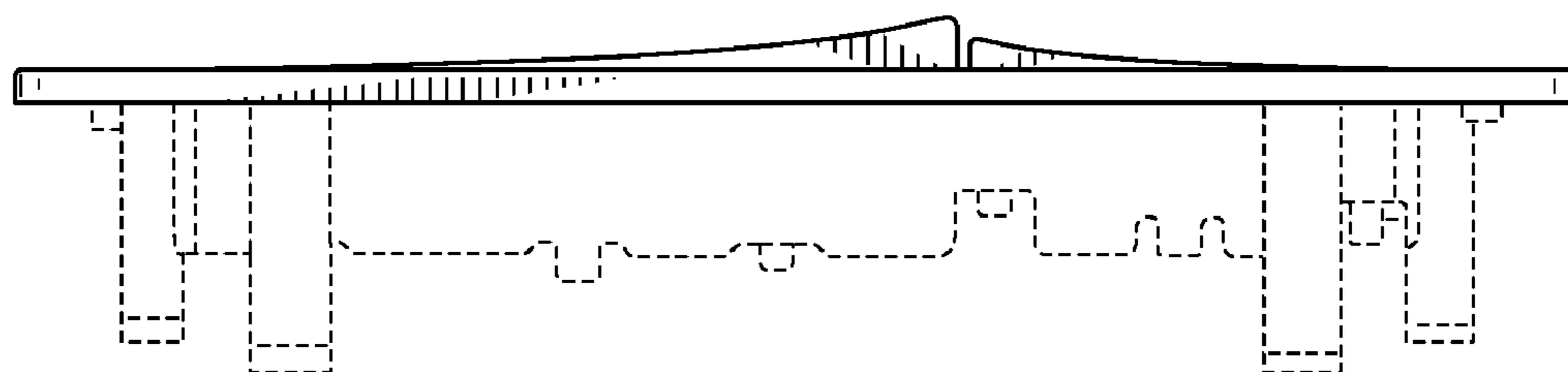

FIG. 3

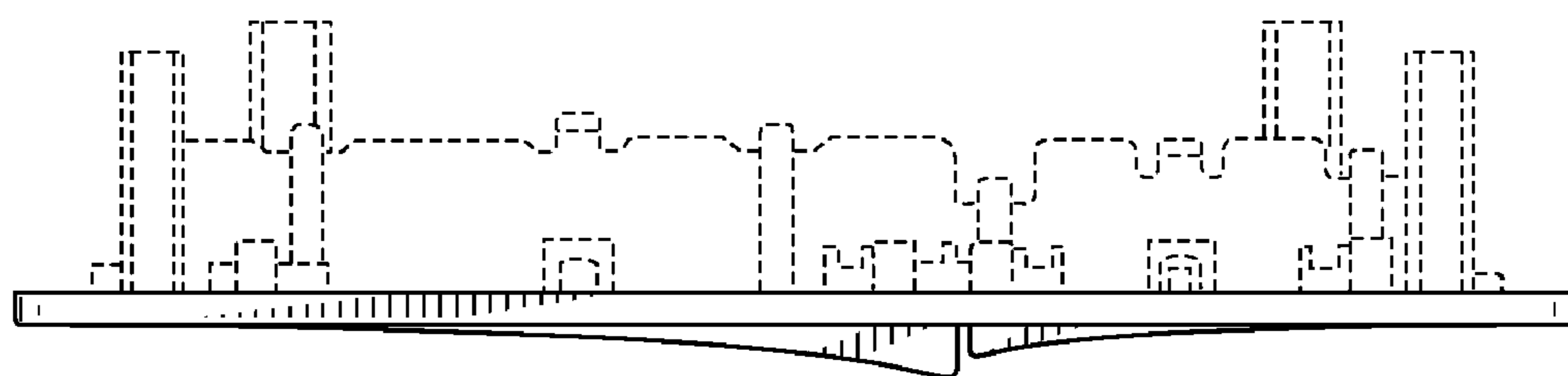

FIG. 4

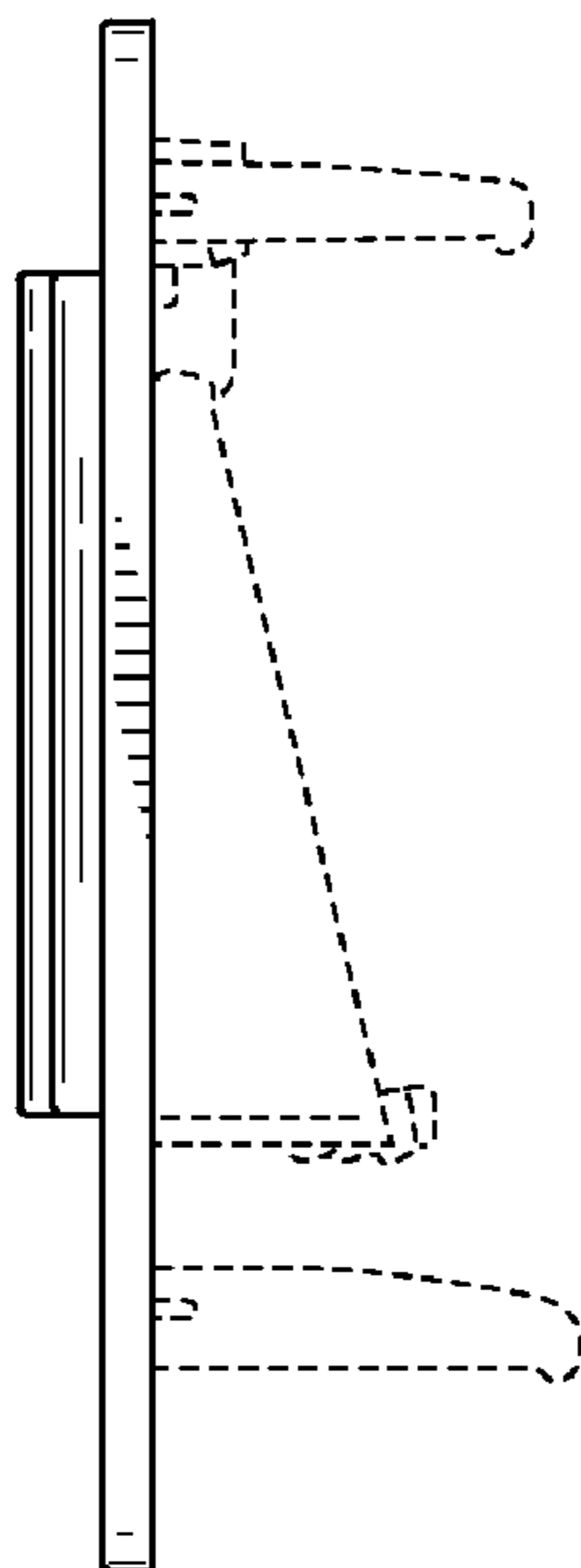

FIG. 5

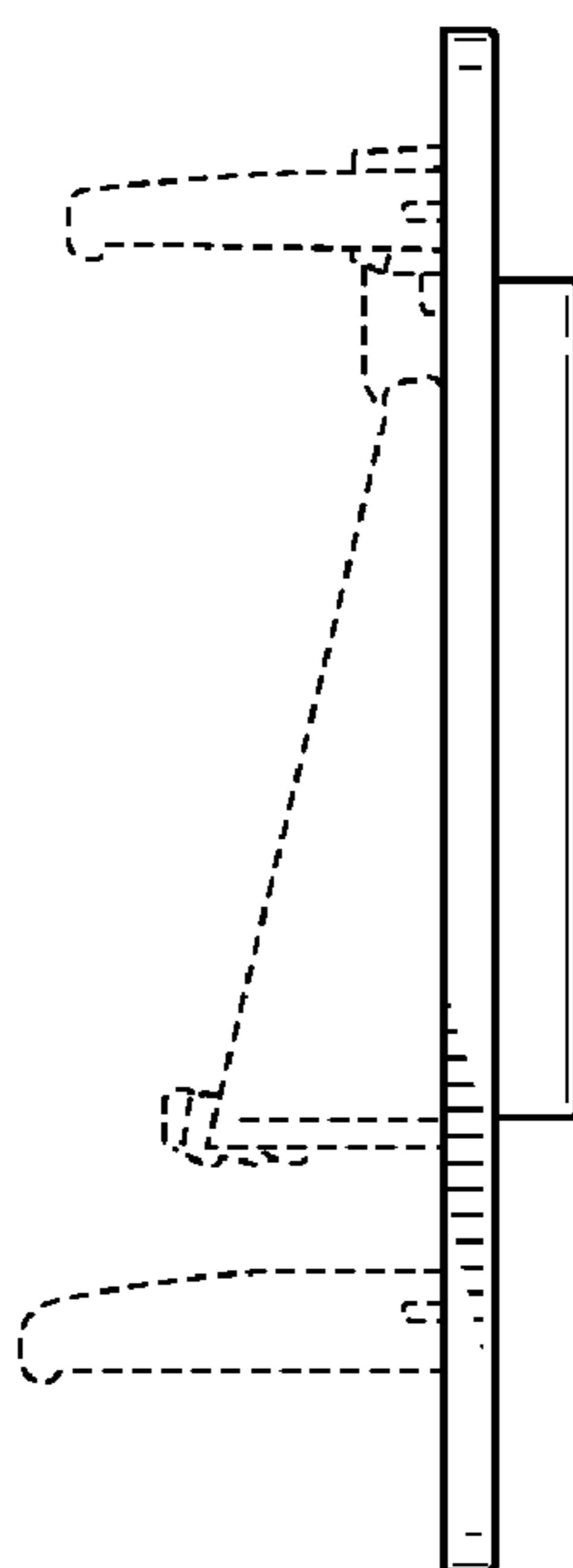

FIG. 6