



US00D645754S

(12) **United States Design Patent**  
**Corbett et al.**

(10) **Patent No.:** **US D645,754 S**

(45) **Date of Patent:** **\*\* \*Sep. 27, 2011**

(54) **CONTAINER**

(75) Inventors: **Julie Corbett**, Oakland, CA (US);  
**Romeo Graham**, Chelsea (CA); **Robert Watters**, Ottawa (CA)

(73) Assignee: **Eco.Logic Brands Inc.**, Oakland, CA (US)

(\*\*) Term: **14 Years**

(21) Appl. No.: **29/380,637**

(22) Filed: **Dec. 8, 2010**

(51) **LOC (9) Cl.** ..... **09-01**

(52) **U.S. Cl.** ..... **D9/523; D9/517; D9/543; D9/530; D9/452**

(58) **Field of Classification Search** ..... D9/516, D9/522, 530, 536-543, 557-558, 563, 571, D9/574, 517, 559-60, 569, 572; 215/379, 215/381-384; 220/660, 662, 669-673, 675  
See application file for complete search history.

(56) **References Cited**

**U.S. PATENT DOCUMENTS**

D99,757 S *	5/1936	Dallas	.....	D9/562
D192,535 S *	4/1962	Laudano	.....	D9/543
D198,404 S *	6/1964	Busch	.....	D9/522
D198,407 S *	6/1964	Busch	.....	D9/543
D201,213 S *	5/1965	Petitto	.....	D9/523
D217,439 S *	5/1970	Platte	.....	D9/543
D258,117 S *	2/1981	Bashour	.....	D9/543
D305,980 S *	2/1990	Binder et al.	.....	D9/543
D368,660 S *	4/1996	Terwilleger et al.	.....	D9/528
D372,429 S *	8/1996	Slezak et al.	.....	D9/528
D373,533 S *	9/1996	Lathrop et al.	.....	D9/528
D373,535 S *	9/1996	Lathrop et al.	.....	D9/528
D374,179 S *	10/1996	Lathrop et al.	.....	D9/528

D376,761 S *	12/1996	Lathrop et al.	.....	D9/528
D401,506 S *	11/1998	Collins et al.	.....	D9/528
D408,742 S *	4/1999	Goettner	.....	D9/543
D429,465 S *	8/2000	Weeden	.....	D9/528
D471,111 S *	3/2003	Kuzma et al.	.....	D9/543
D508,206 S *	8/2005	Meeker et al.	.....	D9/528
D543,466 S	5/2007	Little et al.		
D543,852 S *	6/2007	Warren	.....	D9/523
2011/0036846 A1	2/2011	Corbett et al.		

**FOREIGN PATENT DOCUMENTS**

WO	WO 2007/066090 A1	6/2007
WO	WO 2009/133355 A1	11/2009
WO	WO 2009/133359 A1	11/2009
WO	WO 2009/153558 A1	12/2009

\* cited by examiner

*Primary Examiner* — Ian Simmons

*Assistant Examiner* — Dana L Sipos

(74) *Attorney, Agent, or Firm* — Wilson Sonsini Goodrich & Rosati

(57) **CLAIM**

The ornamental design for a container, as shown and described.

**DESCRIPTION**

FIG. 1 is a top perspective view of a container showing our new design;

FIG. 2 is a top plan view thereof;

FIG. 3 is a front elevational view thereof;

FIG. 4 is a right side elevational view thereof;

FIG. 5 is a left elevational view thereof;

FIG. 6 is a rear side elevational view thereof; and,

FIG. 7 is a bottom plan view thereof.

**1 Claim, 7 Drawing Sheets**

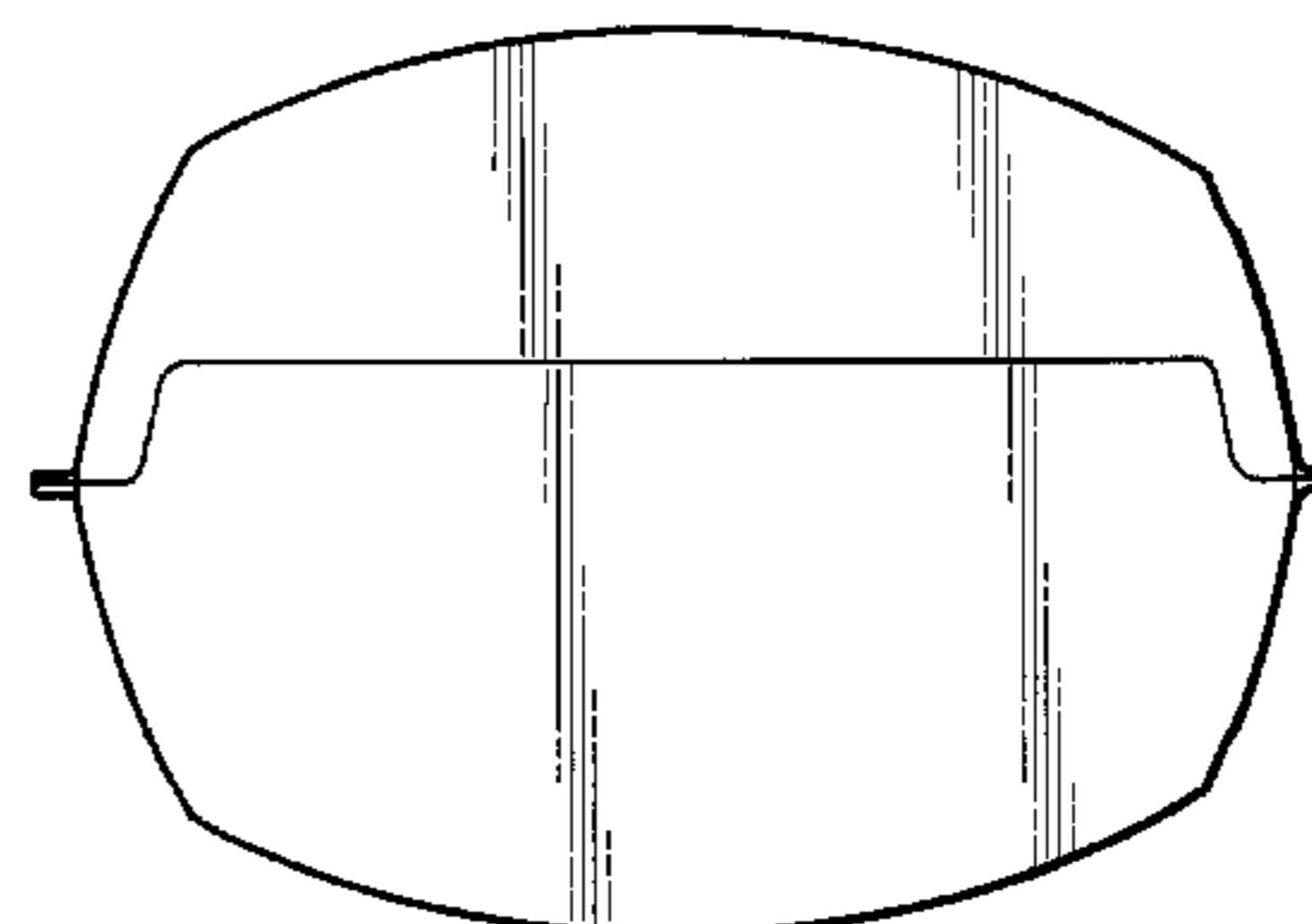
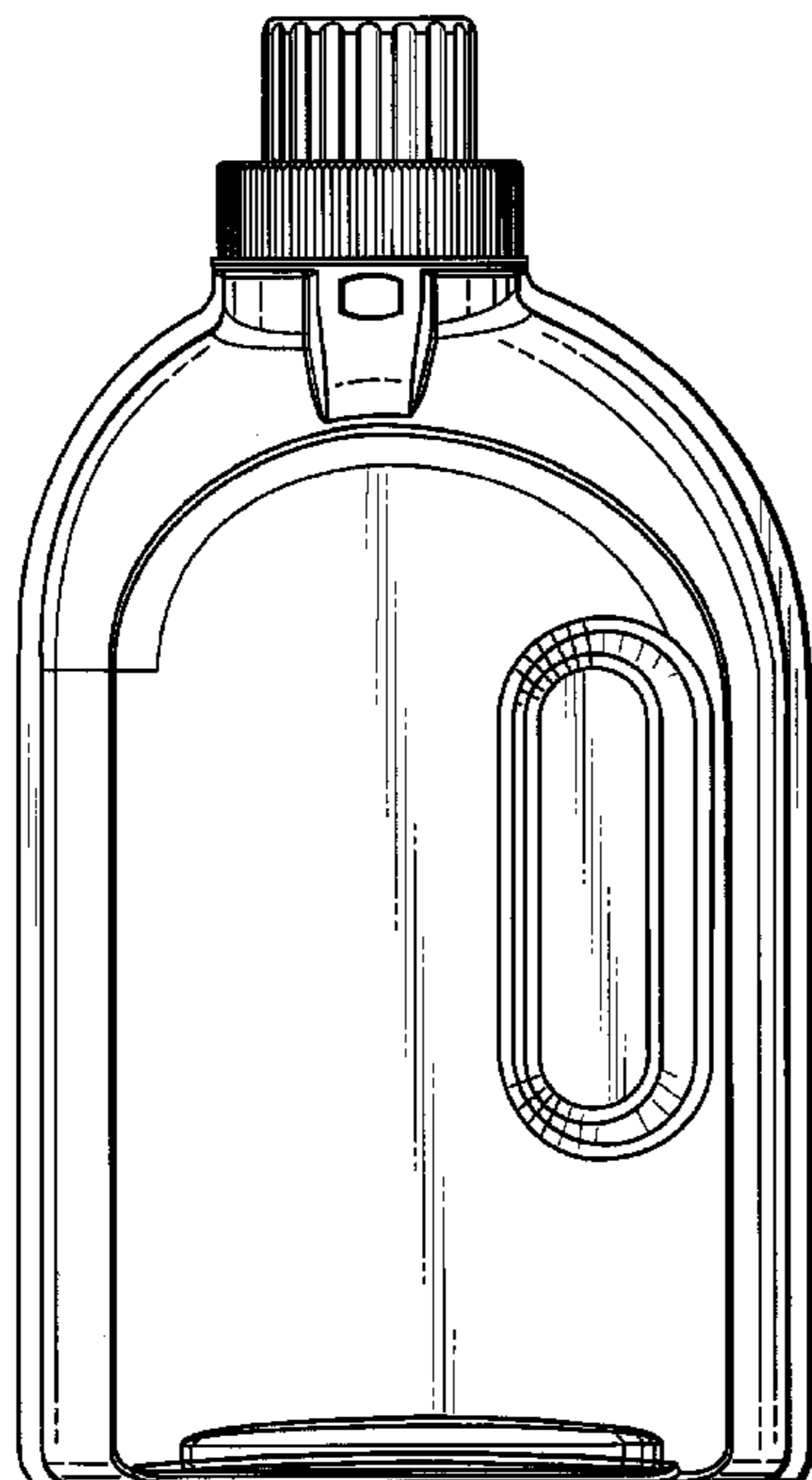

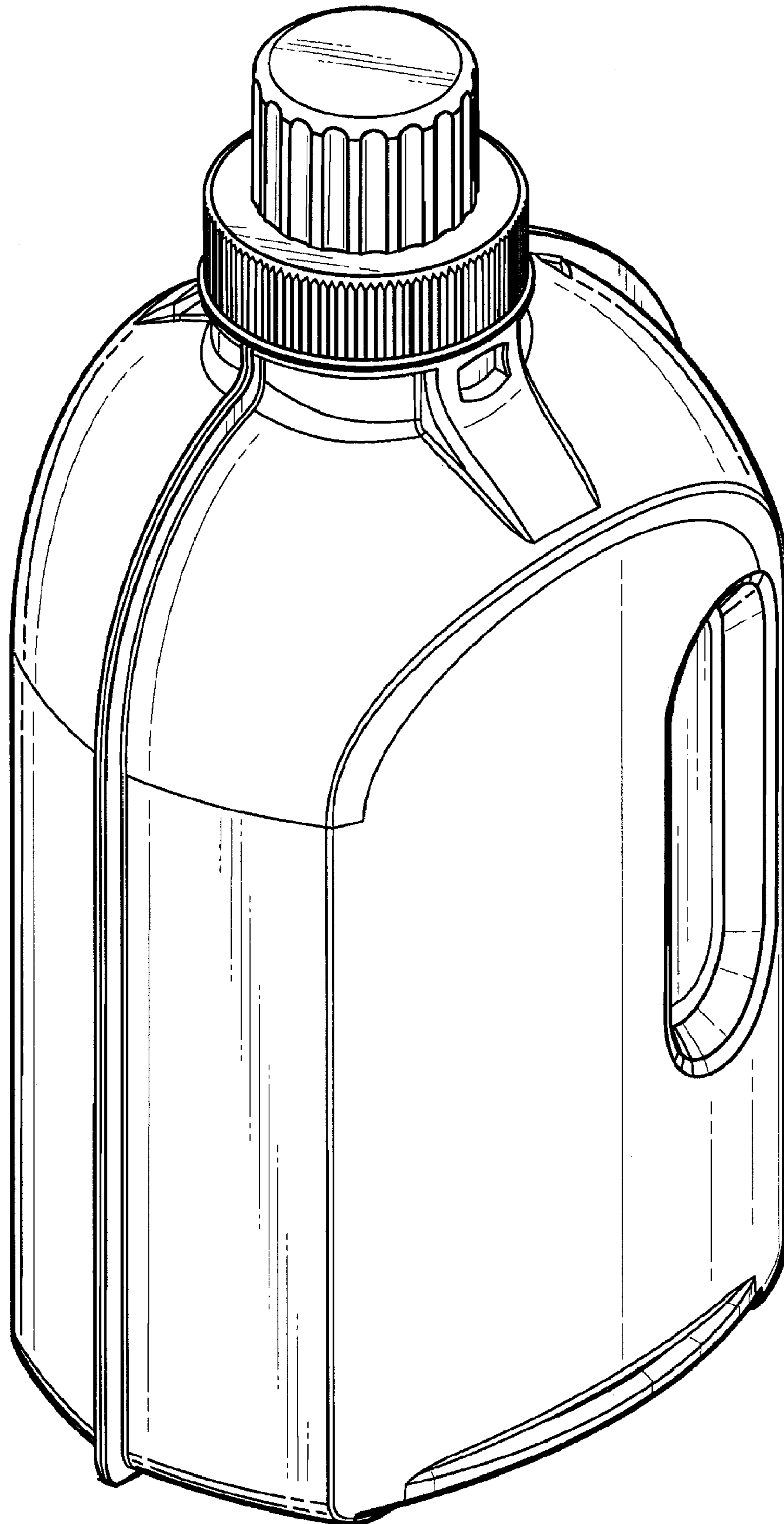

**FIG. 1**

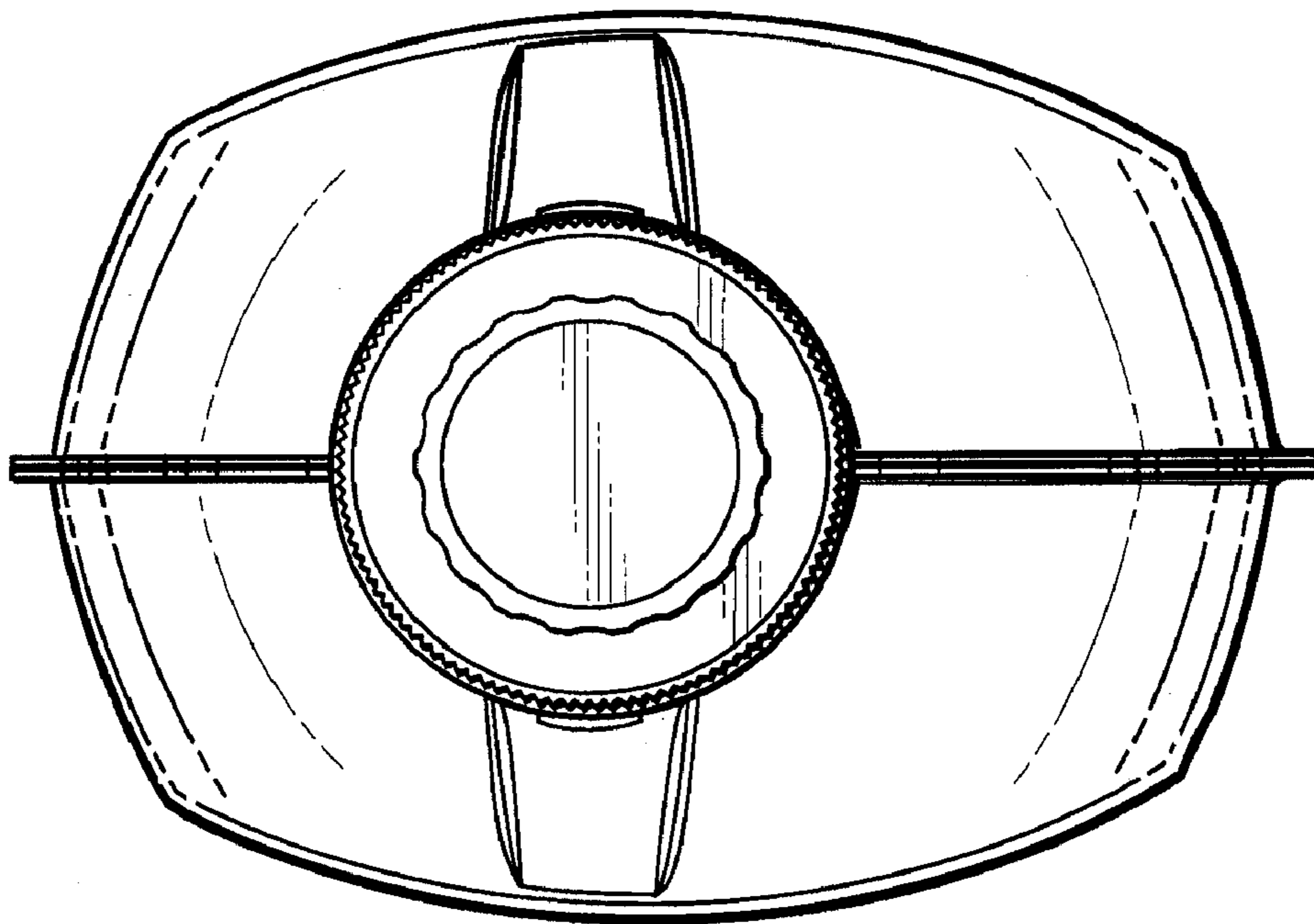

**FIG. 2**

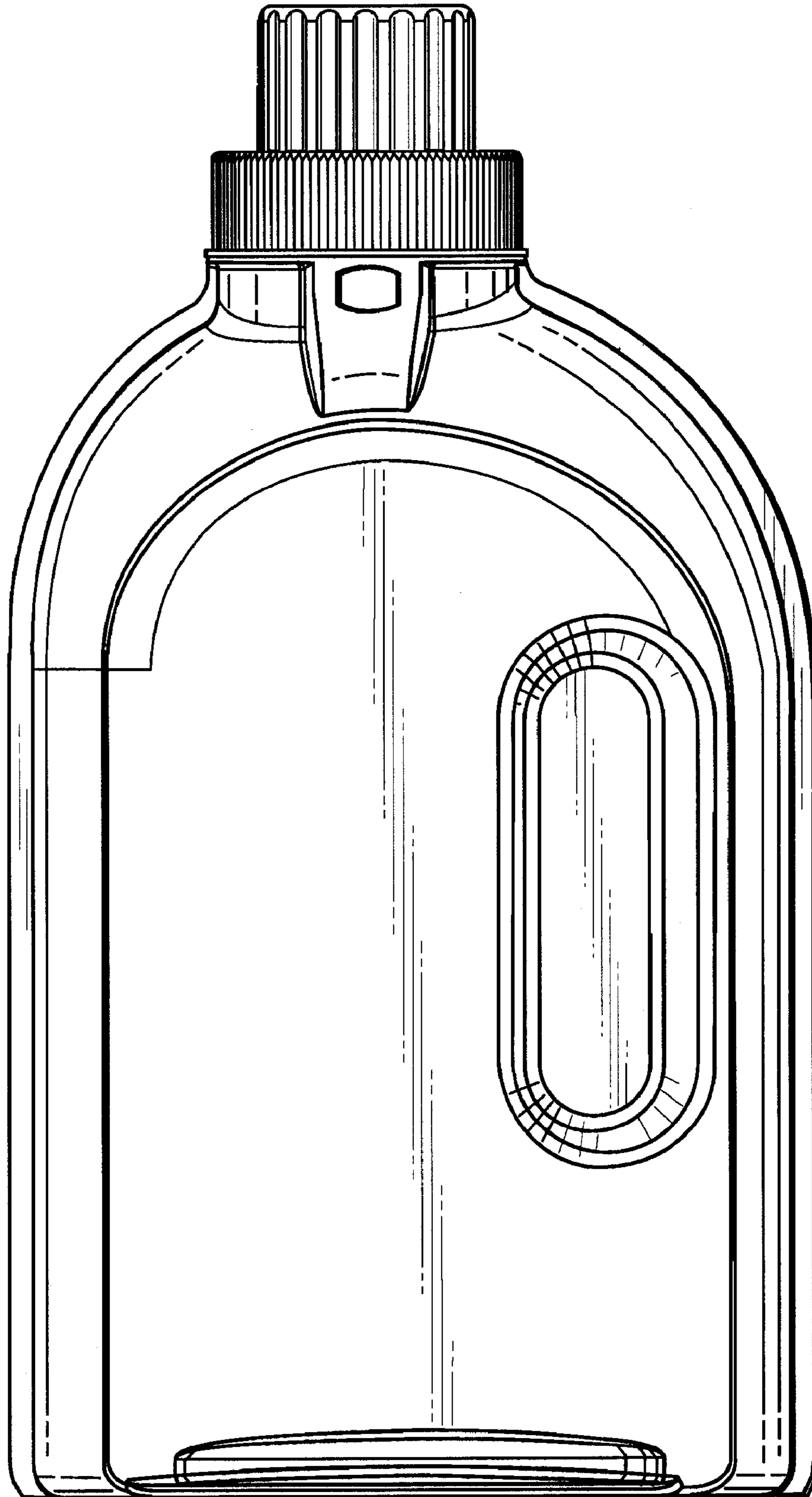
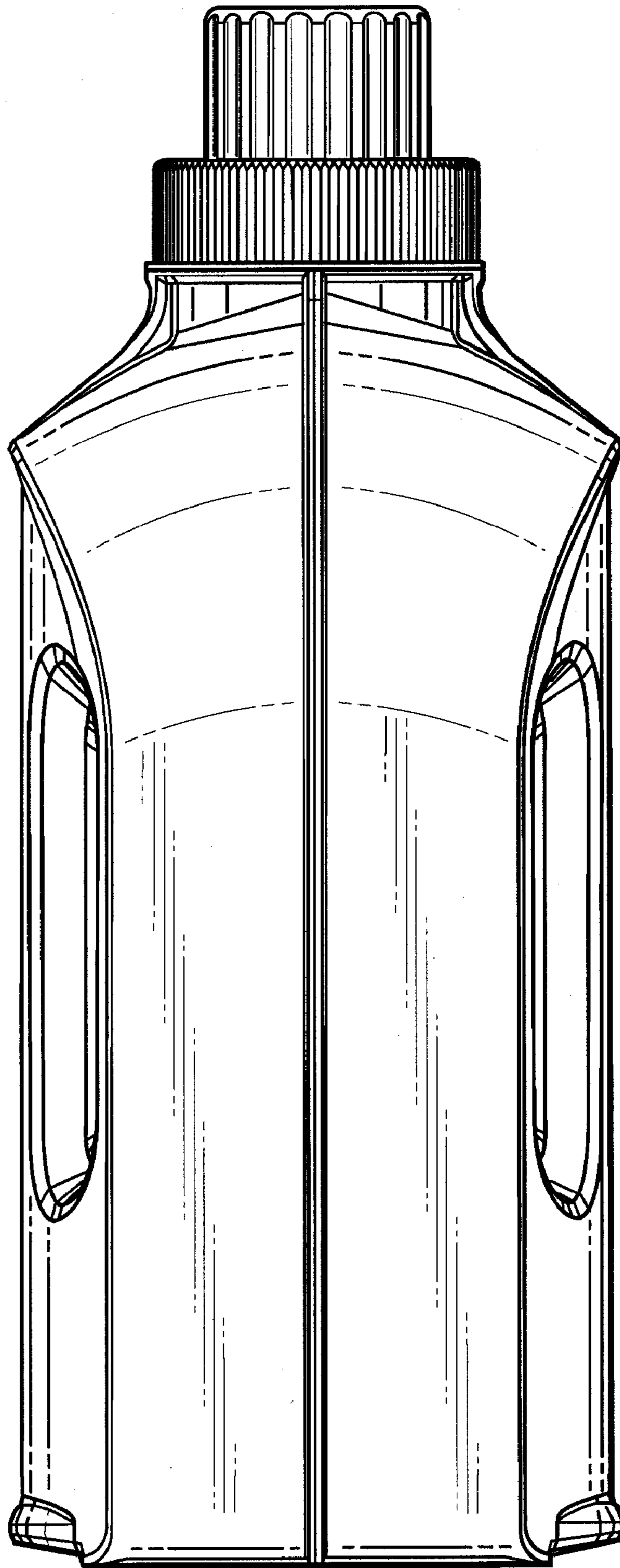
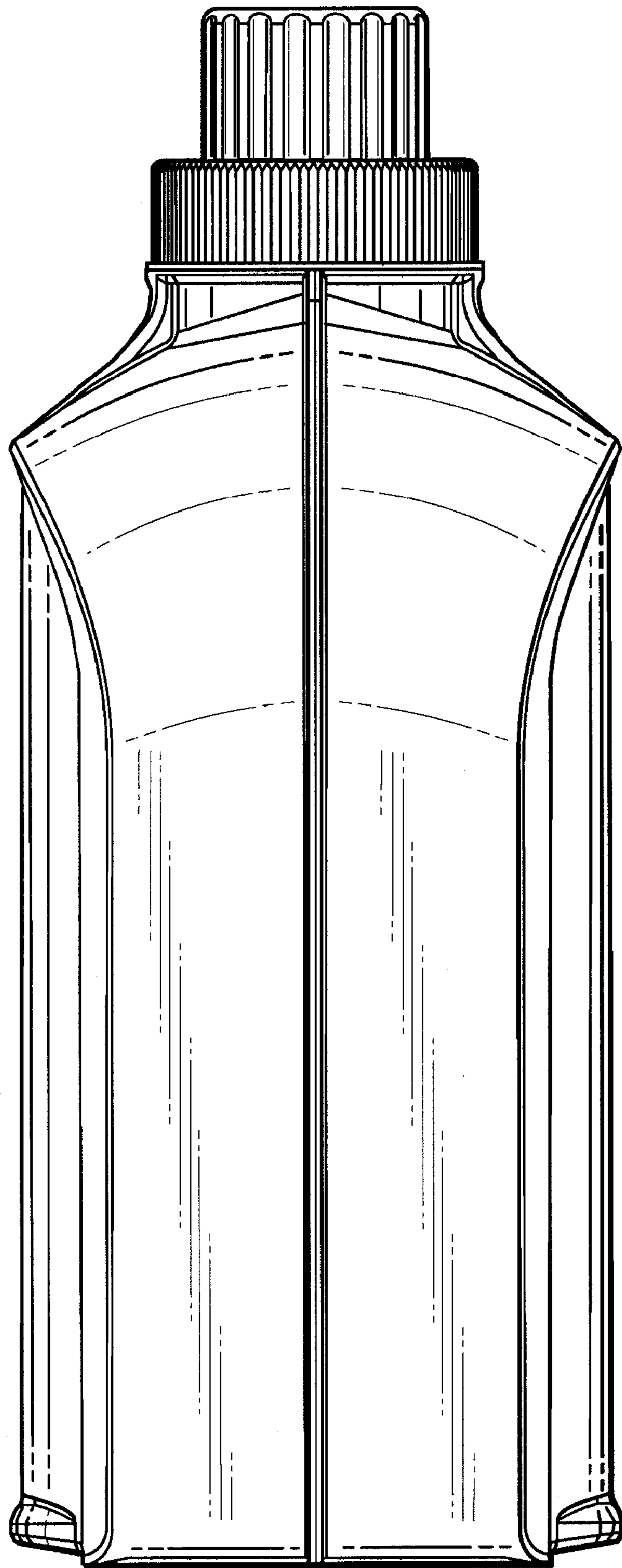

FIG. 3



**FIG. 4**



**FIG. 5**

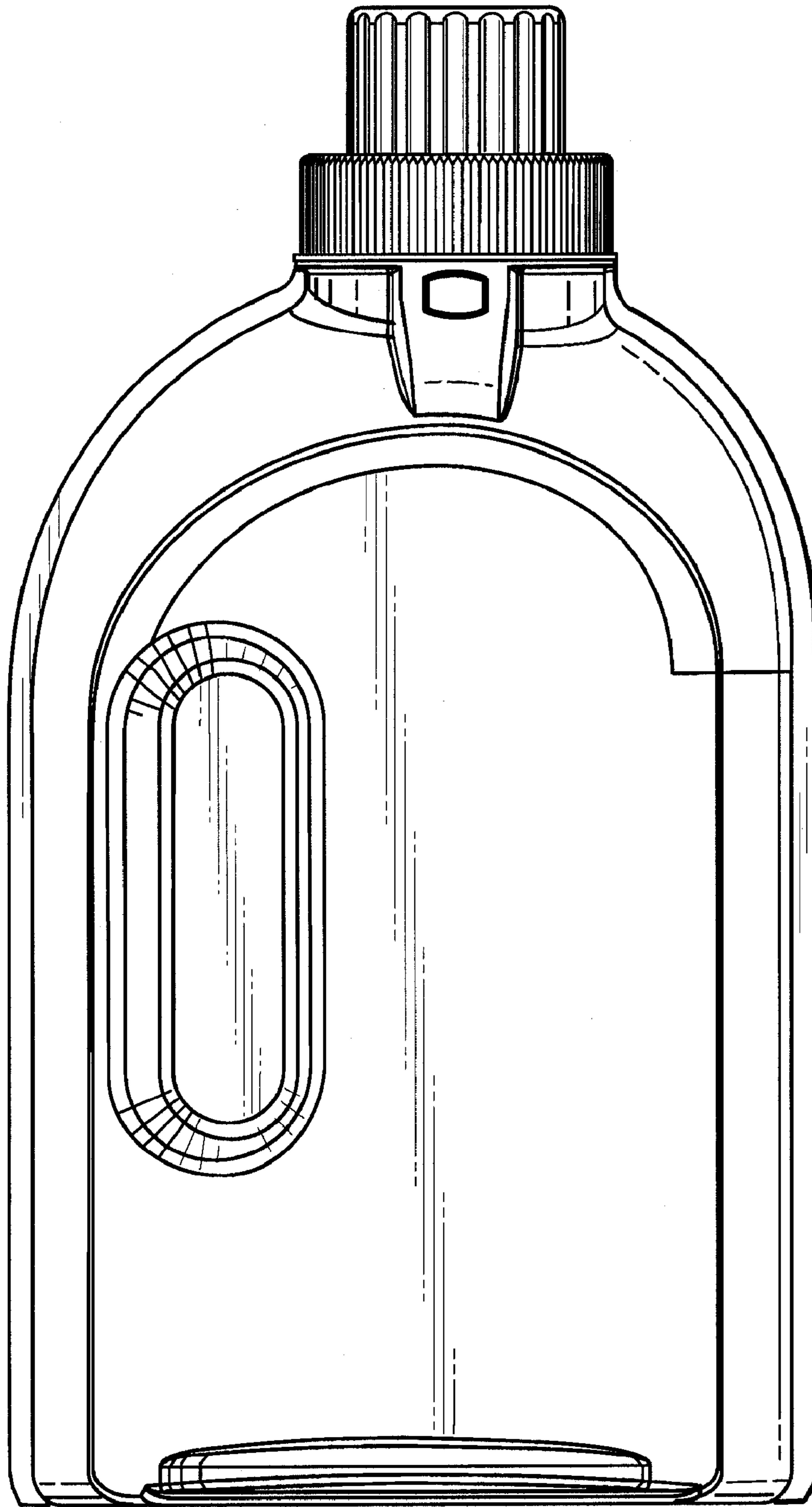
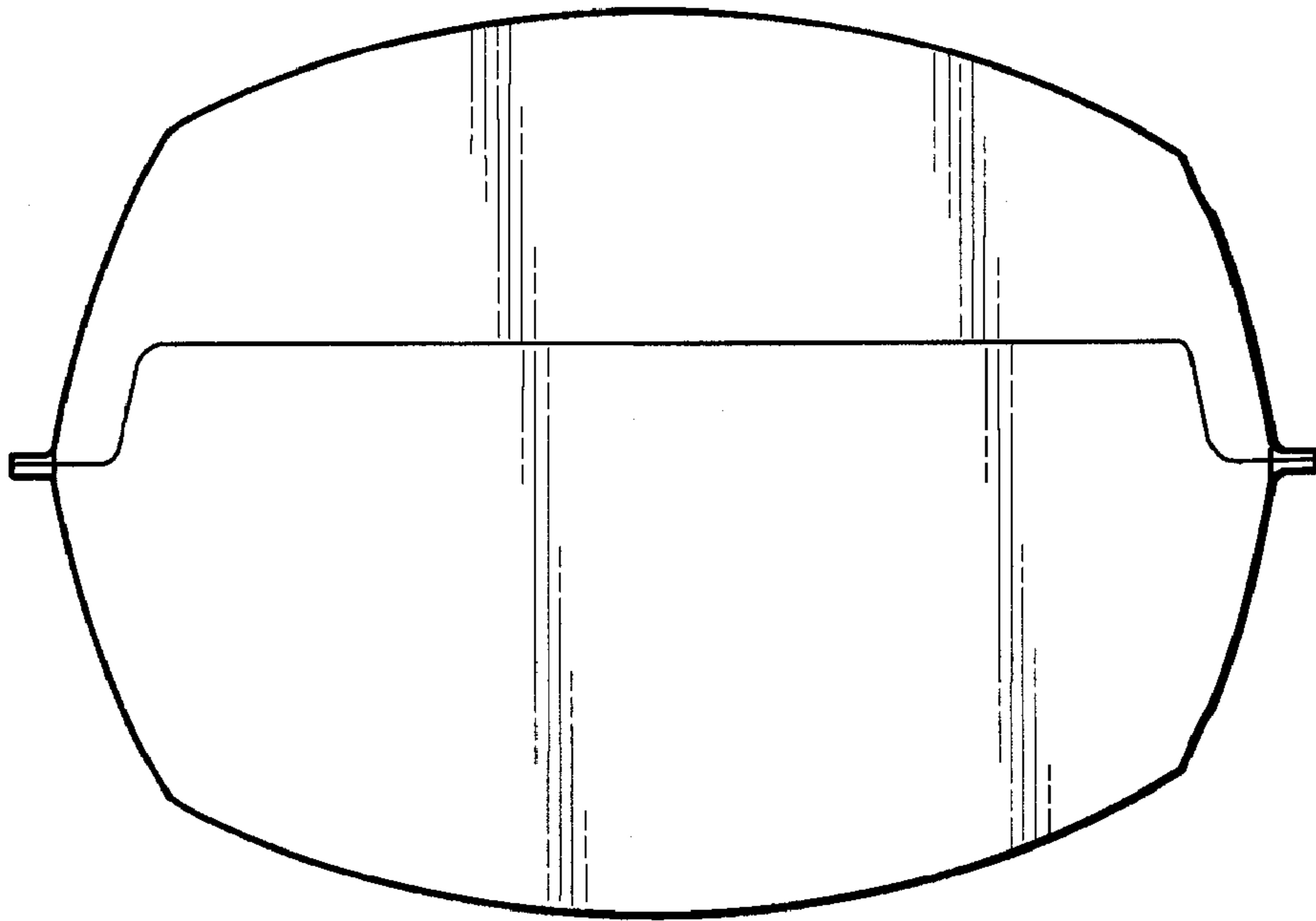

FIG. 6



**FIG. 7**