



US00D645747S

(12) **United States Design Patent**
Yu

(10) **Patent No.:** **US D645,747 S**

(45) **Date of Patent:** **** Sep. 27, 2011**

(54) **COSMETIC CONTAINER**

(75) Inventor: **In Jung Yu**, Seoul (KR)

(73) Assignee: **Amorepacific Corporation**, Seoul (KR)

(**) Term: **14 Years**

(21) Appl. No.: **29/382,303**

(22) Filed: **Dec. 30, 2010**

(30) **Foreign Application Priority Data**

Sep. 8, 2010 (KR) 30-2010-0039622

(51) **LOC (9) Cl.** **09-01**

(52) **U.S. Cl.** **D9/503; D9/445; D9/454**

(58) **Field of Classification Search** D9/500,

D9/502-505, 516, 537, 539, 544-545, 549,

D9/558, 574-575, 444-445, 454, 682, 686,

D9/688-693; D28/4, 8, 76, 78, 82; 215/379,

215/382-384; 220/660, 662, 669, 675

See application file for complete search history.

(56) **References Cited**

U.S. PATENT DOCUMENTS

D208,885 S *	10/1967	Roehrich	D9/503
D269,316 S *	6/1983	Conti	D7/591
D547,661 S *	7/2007	Blasko et al.	D9/529
D597,840 S *	8/2009	Biesecker et al.	D9/454
D633,389 S *	3/2011	Jorgensen	D9/503

* cited by examiner

Primary Examiner — Ian Simmons

Assistant Examiner — Dana L Sipos

(57) **CLAIM**

The ornamental design for a cosmetic container, as shown and described.

DESCRIPTION

FIG. 1 is a perspective view of a cosmetic container;
 FIG. 2 is a front view of the cosmetic container of FIG. 1;
 FIG. 3 is a rear view of the cosmetic container of FIG. 1;
 FIG. 4 is a left-side view of the cosmetic container of FIG. 1;
 FIG. 5 is a right-side view of the cosmetic container of FIG. 1;
 FIG. 6 is a top plan view of the cosmetic container of FIG. 1;
 FIG. 7 is a bottom plan view of the cosmetic container of FIG. 1;
 and,
 FIG. 8 is an exploded view of the cosmetic container of FIG. 1.

1 Claim, 8 Drawing Sheets

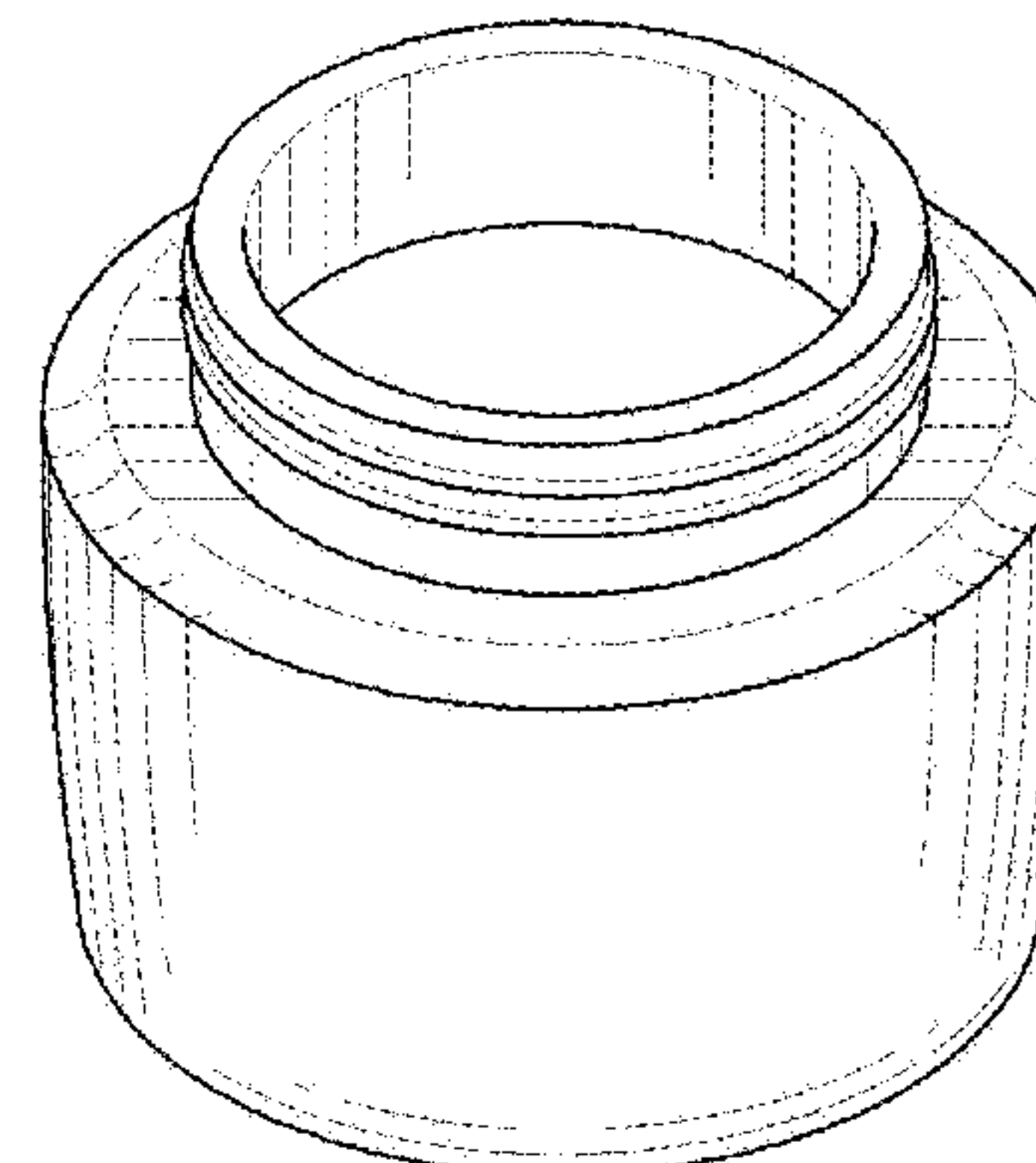
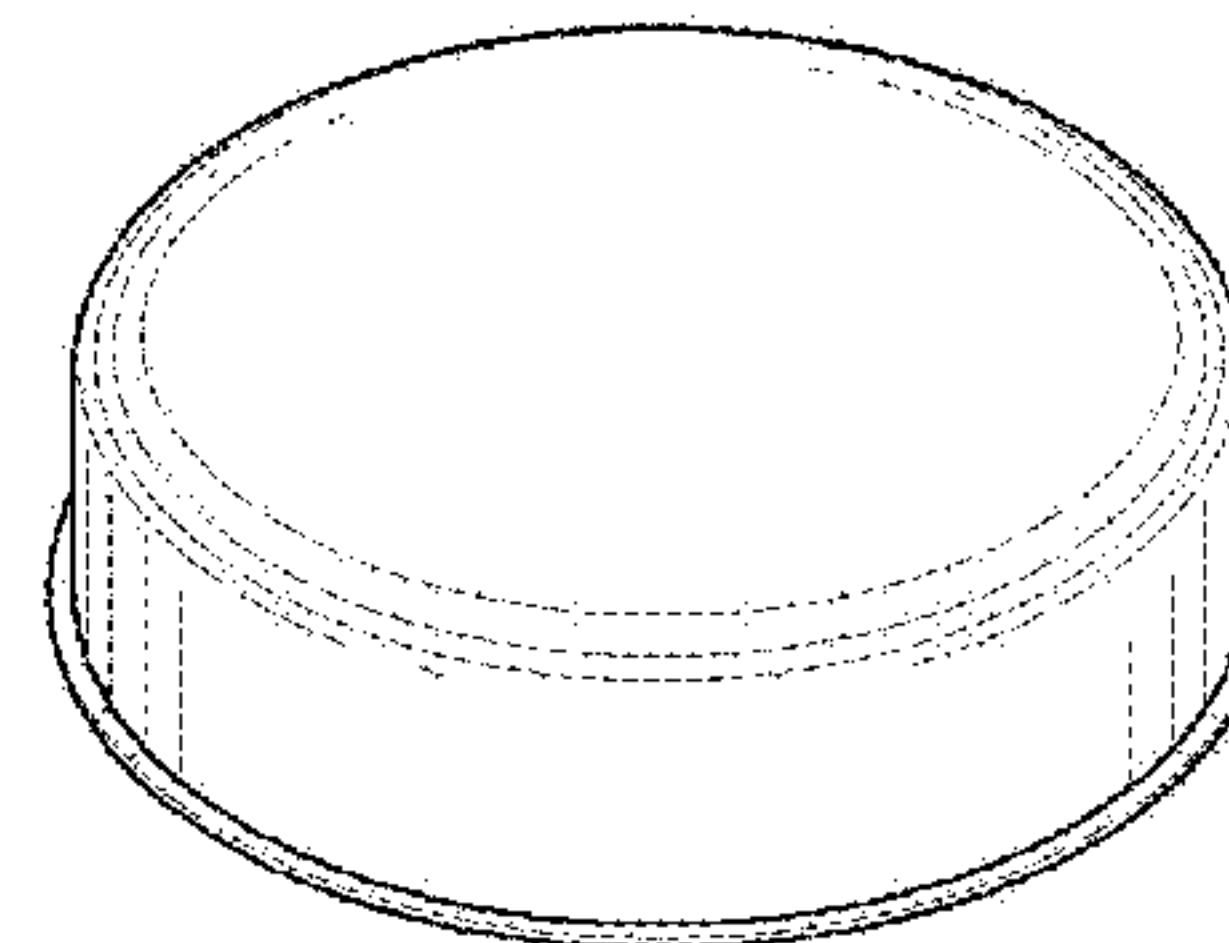
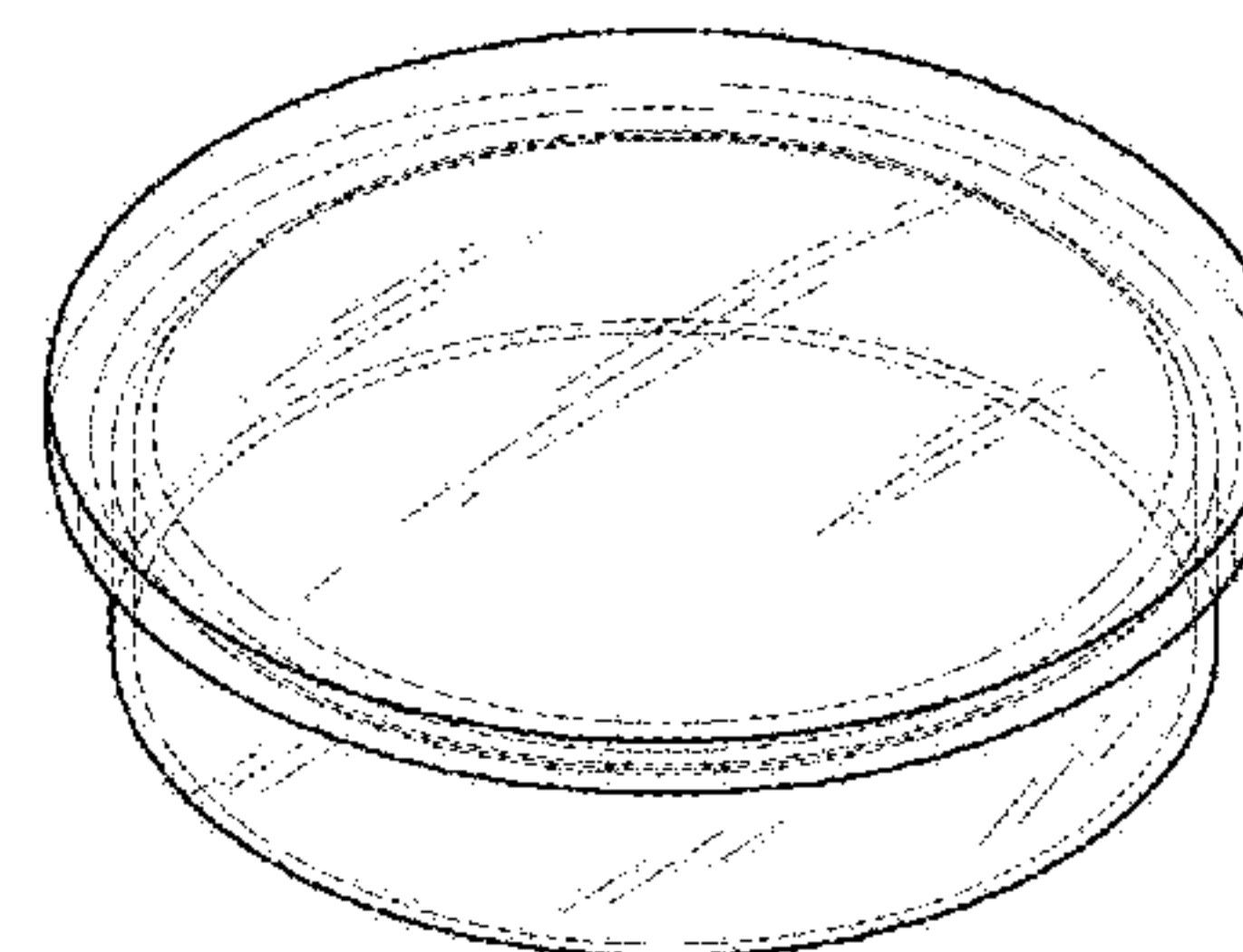
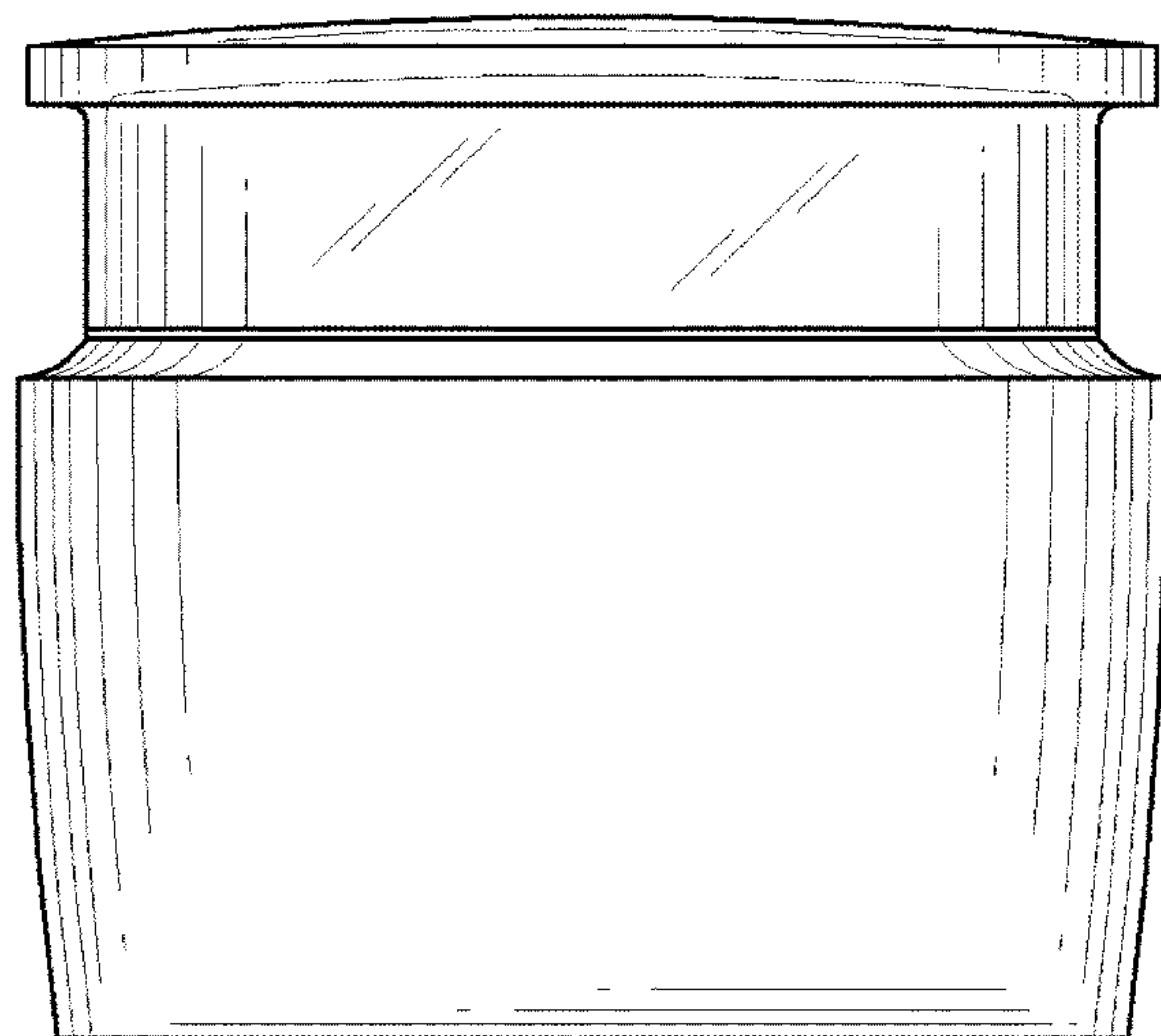

FIG.1



FIG.2

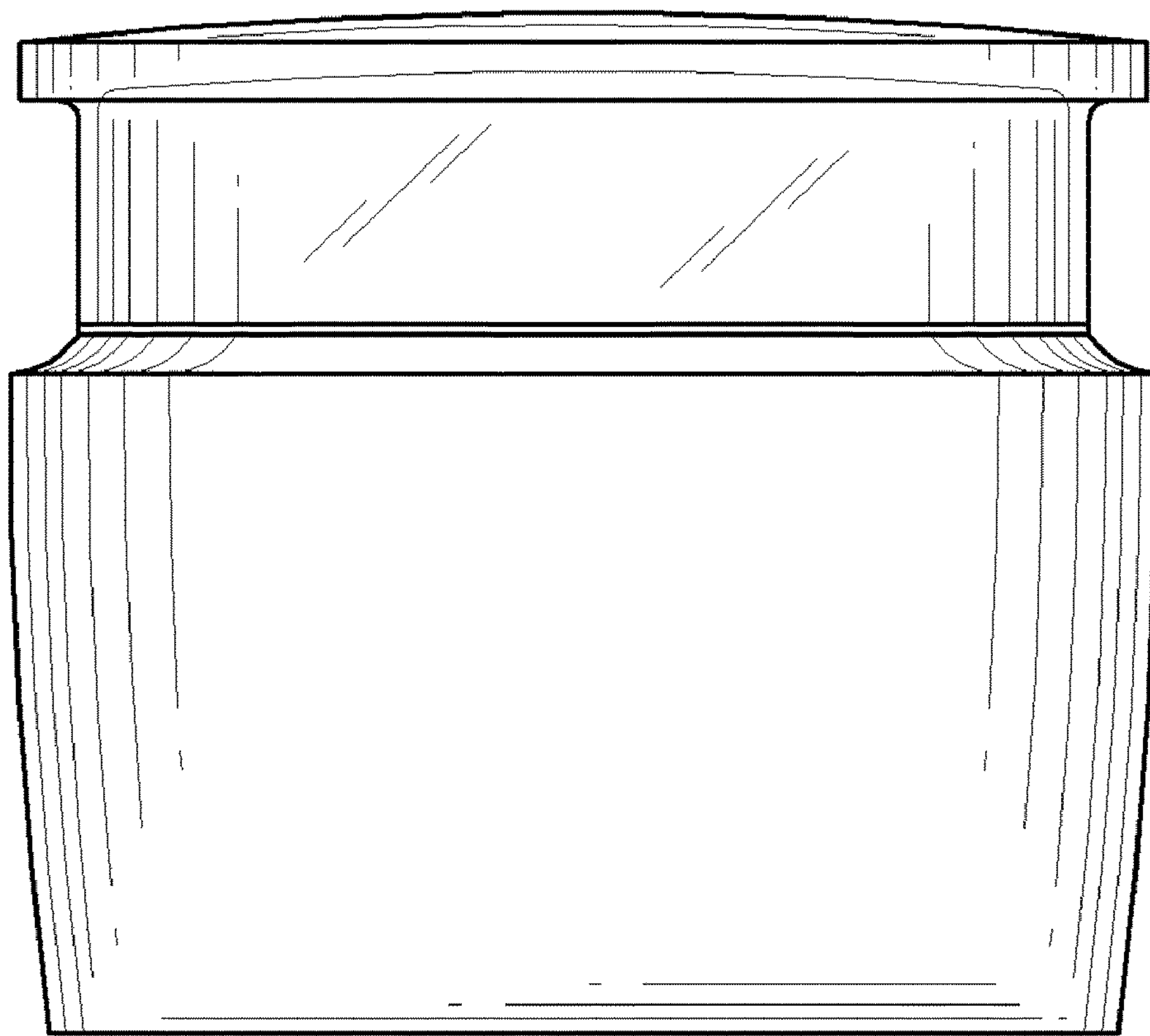

FIG.3

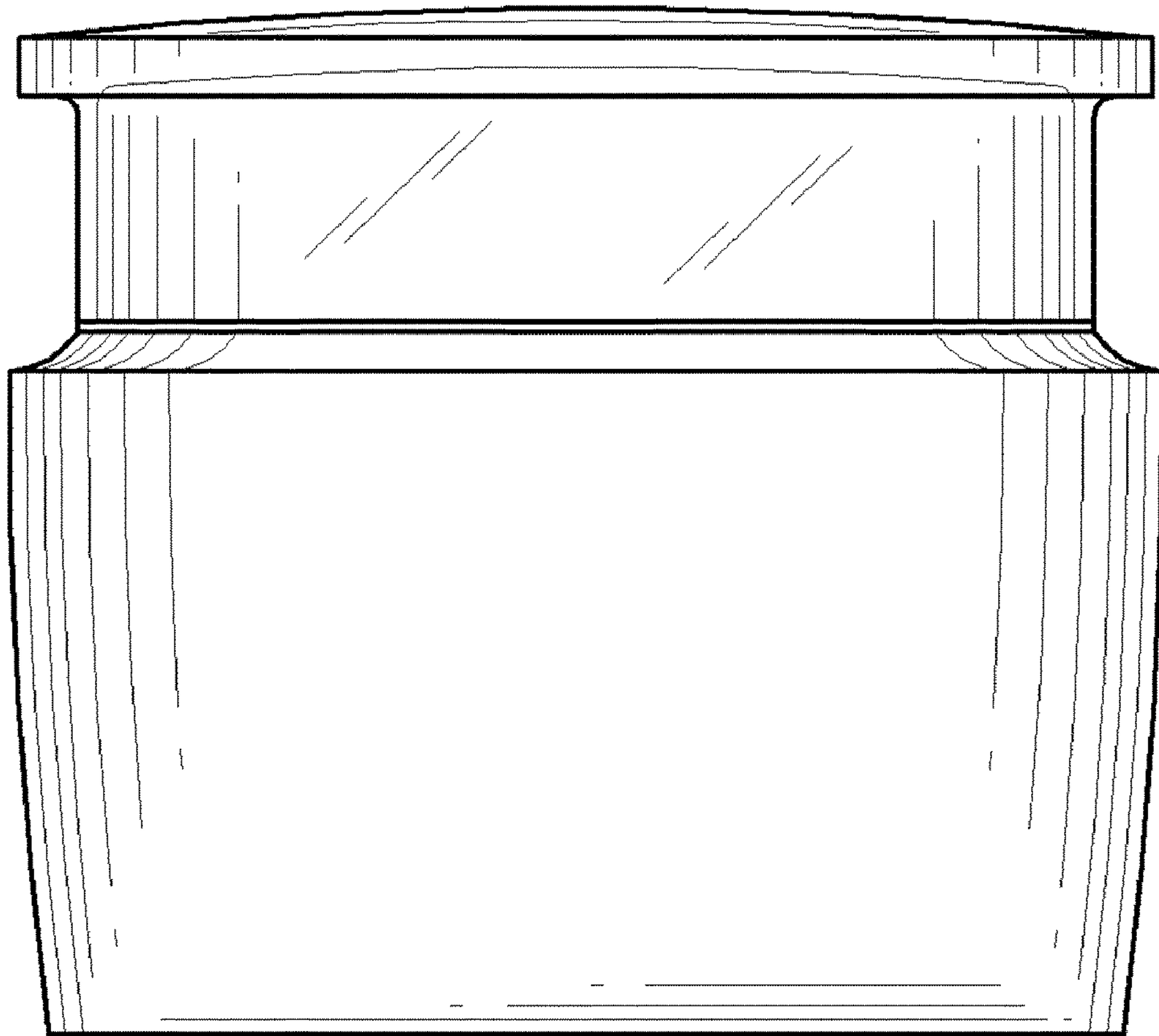

FIG.4

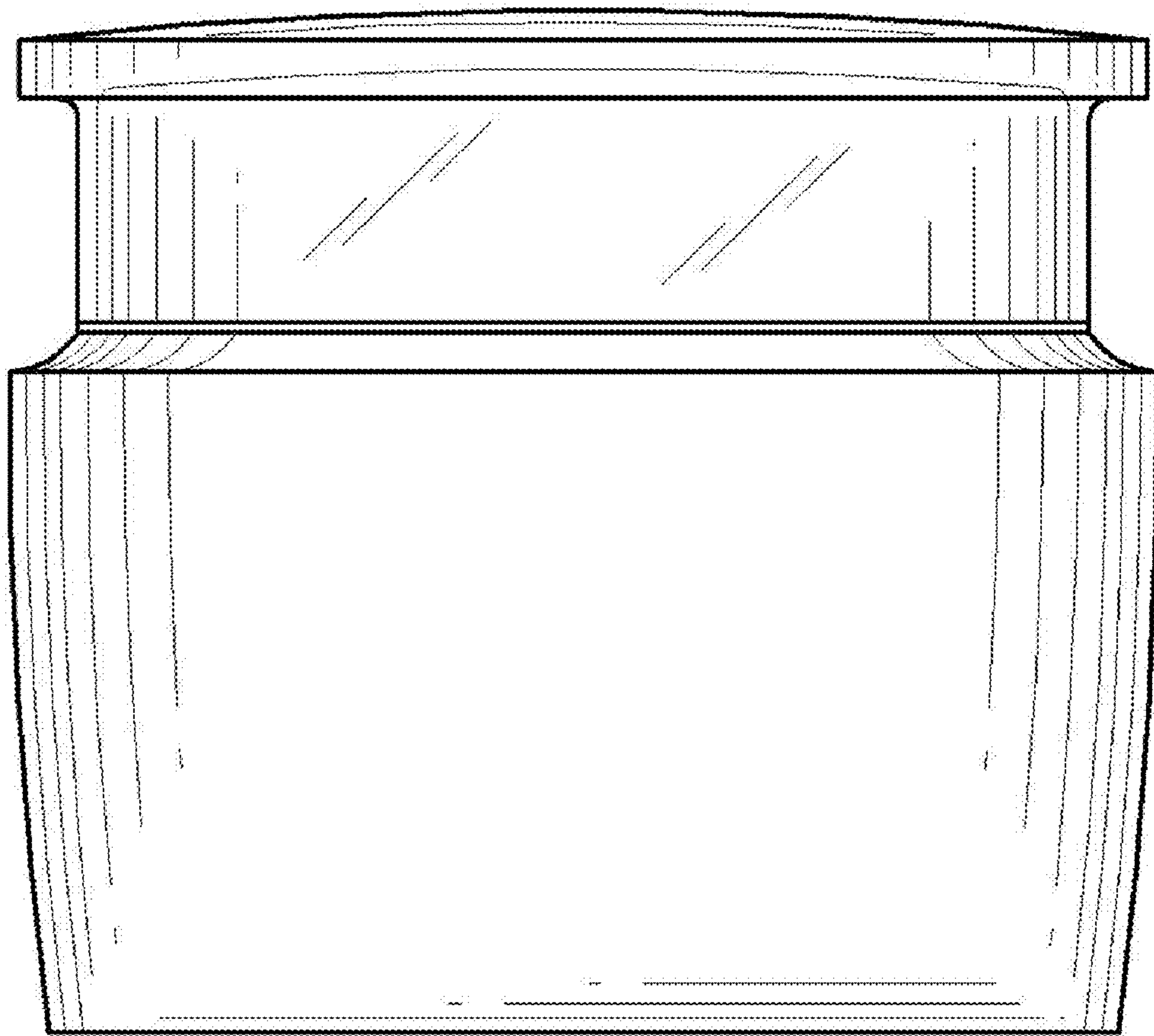

FIG.5

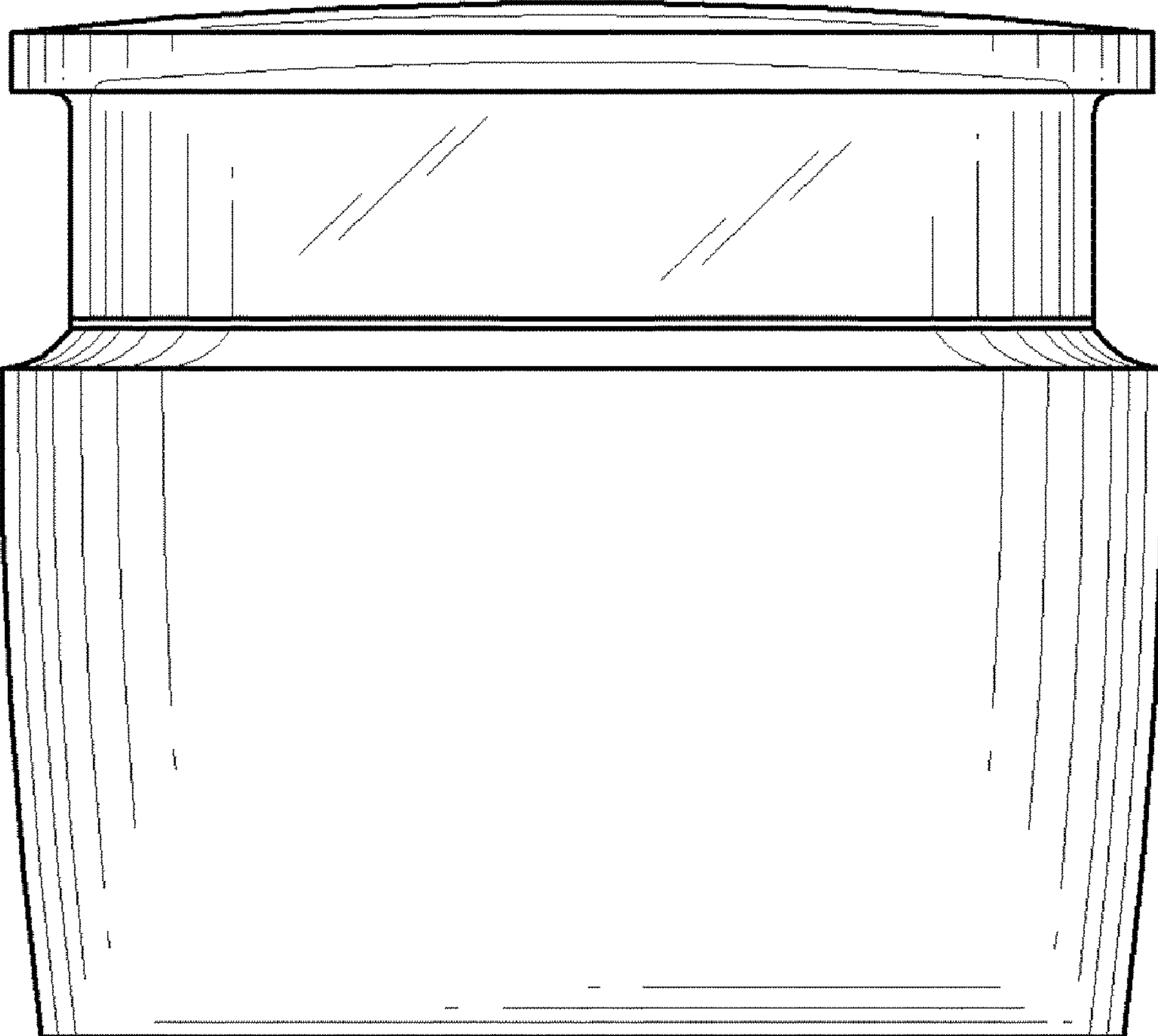

FIG.6

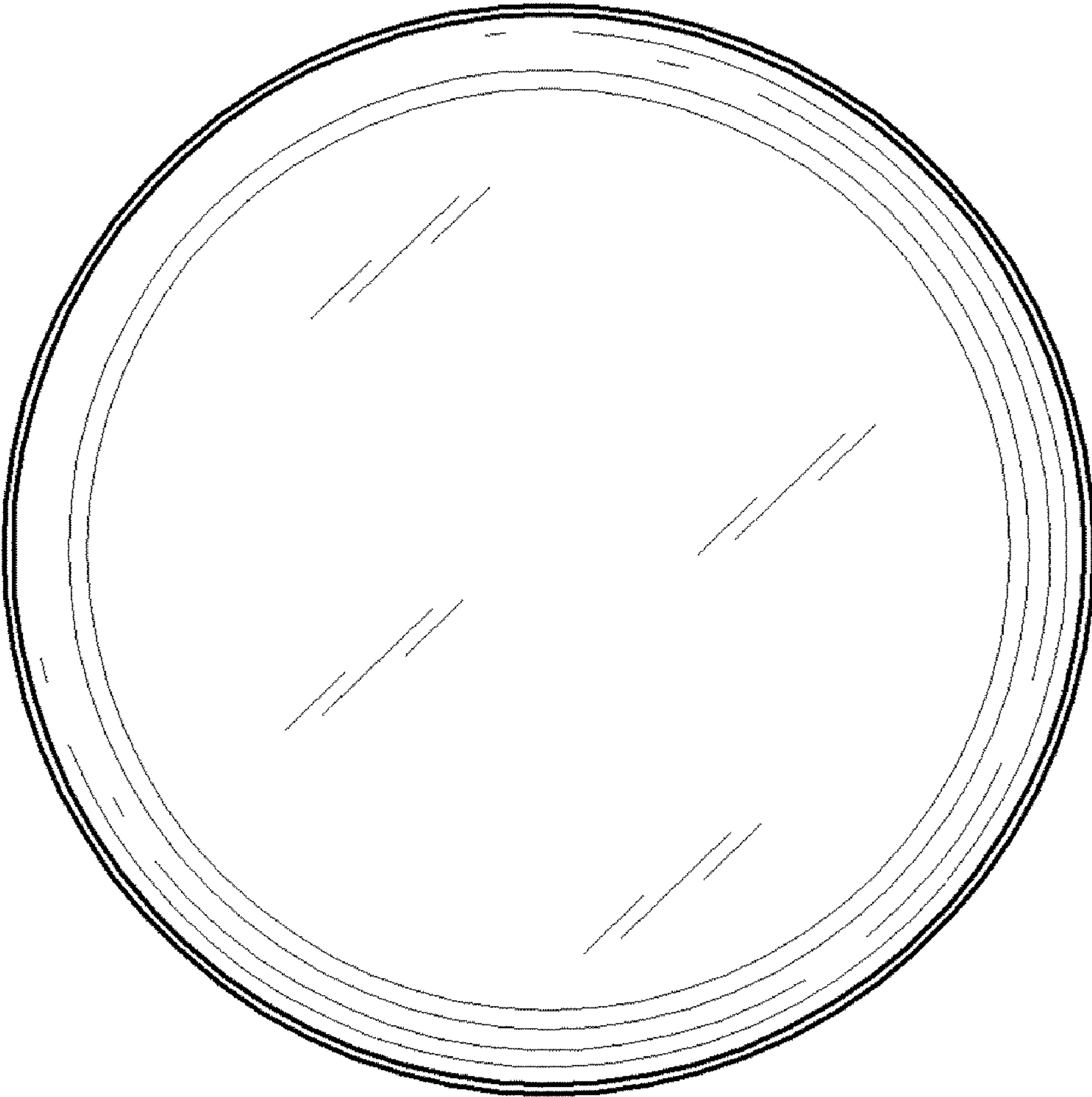

FIG.7

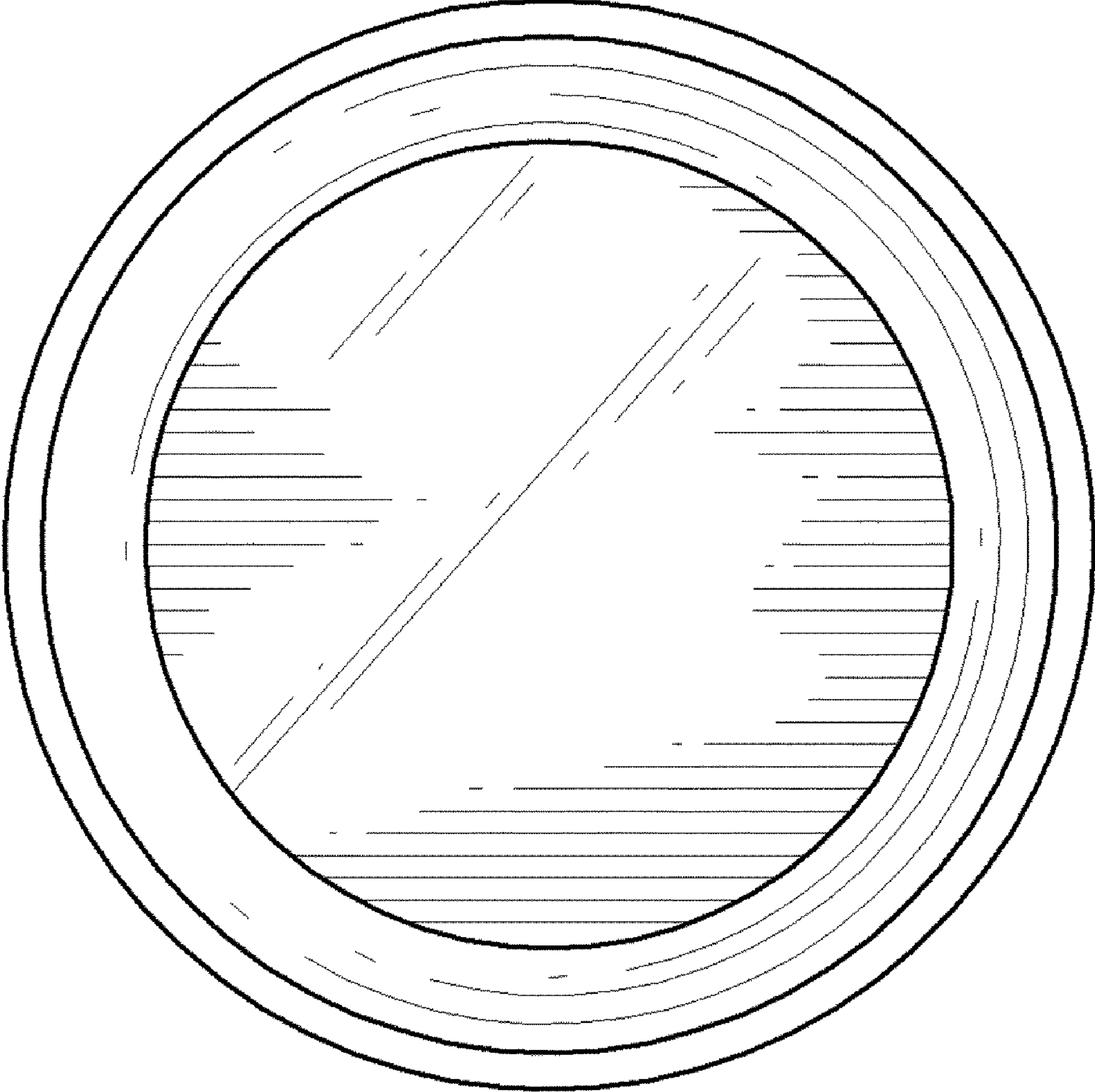

FIG.8

