



US00D645736S

(12) **United States Design Patent**
Hall

(10) **Patent No.:** **US D645,736 S**

(45) **Date of Patent:** **** Sep. 27, 2011**

(54) **CIGARETTE PACKAGING**

(75) Inventor: **John Hall**, London (GB)

(73) Assignee: **JT International S.A.**, Geneva (CH)

(**) Term: **14 Years**

(21) Appl. No.: **29/379,832**

(22) Filed: **Nov. 24, 2010**

(30) **Foreign Application Priority Data**

May 25, 2010 (GB) 4015697

(51) **LOC (9) Cl.** **09-03**

(52) **U.S. Cl.** **D9/423**

(58) **Field of Classification Search** D9/414,
D9/416, 420, 421, 423, 426, 430, 432; 206/236-241,
206/249-251, 254-259, 261-275; 229/160.1;
D27/172-176, 185-192

See application file for complete search history.

(56) **References Cited**

U.S. PATENT DOCUMENTS

3,721,335	A *	3/1973	Grant	206/256
5,178,268	A *	1/1993	Talley et al.	206/256
5,180,056	A *	1/1993	Adams et al.	206/256
6,223,895	B1 *	5/2001	Bowen et al.	206/236
6,491,161	B1 *	12/2002	Focke et al.	206/264

D492,814	S *	7/2004	Bray et al.	D27/189
D492,815	S *	7/2004	Bray et al.	D27/189
D503,014	S *	3/2005	Bray et al.	D27/189
D519,673	S *	4/2006	Bray et al.	D27/189
D537,561	S *	2/2007	Counts et al.	D27/189
D539,474	S *	3/2007	Counts et al.	D27/189
D541,978	S *	5/2007	Counts et al.	D27/189
D586,502	S *	2/2009	Tearle	D27/189
D591,901	S *	5/2009	Tearle	D27/189
D607,319	S *	1/2010	Collins	D9/423
D607,717	S *	1/2010	Hodges	D9/423

* cited by examiner

Primary Examiner — Thomas Johannes

(74) *Attorney, Agent, or Firm* — Hovey Williams LLP

(57) **CLAIM**

The ornamental design for a cigarette packaging, as shown and described.

DESCRIPTION

FIG. 1 is a front perspective view of a cigarette packaging showing my new design;

FIG. 2 is a front elevation view thereof;

FIG. 3 is a rear elevation view thereof;

FIG. 4 is a top plan view thereof;

FIG. 5 is a bottom plan view thereof;

FIG. 6 is a left end elevation view thereof, the right end being a mirror image thereof; and,

FIG. 7 is a perspective view of the cigarette packaging in a partially unfolded position.

1 Claim, 5 Drawing Sheets

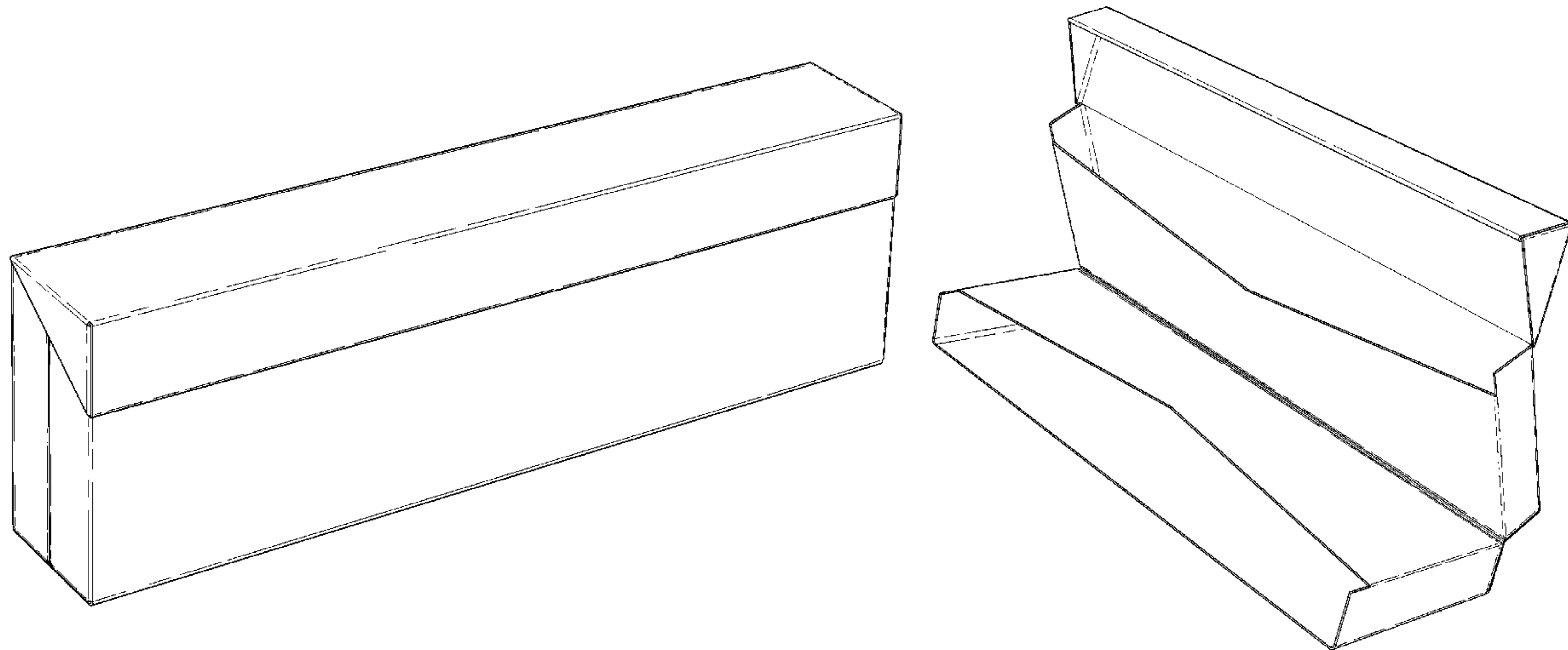

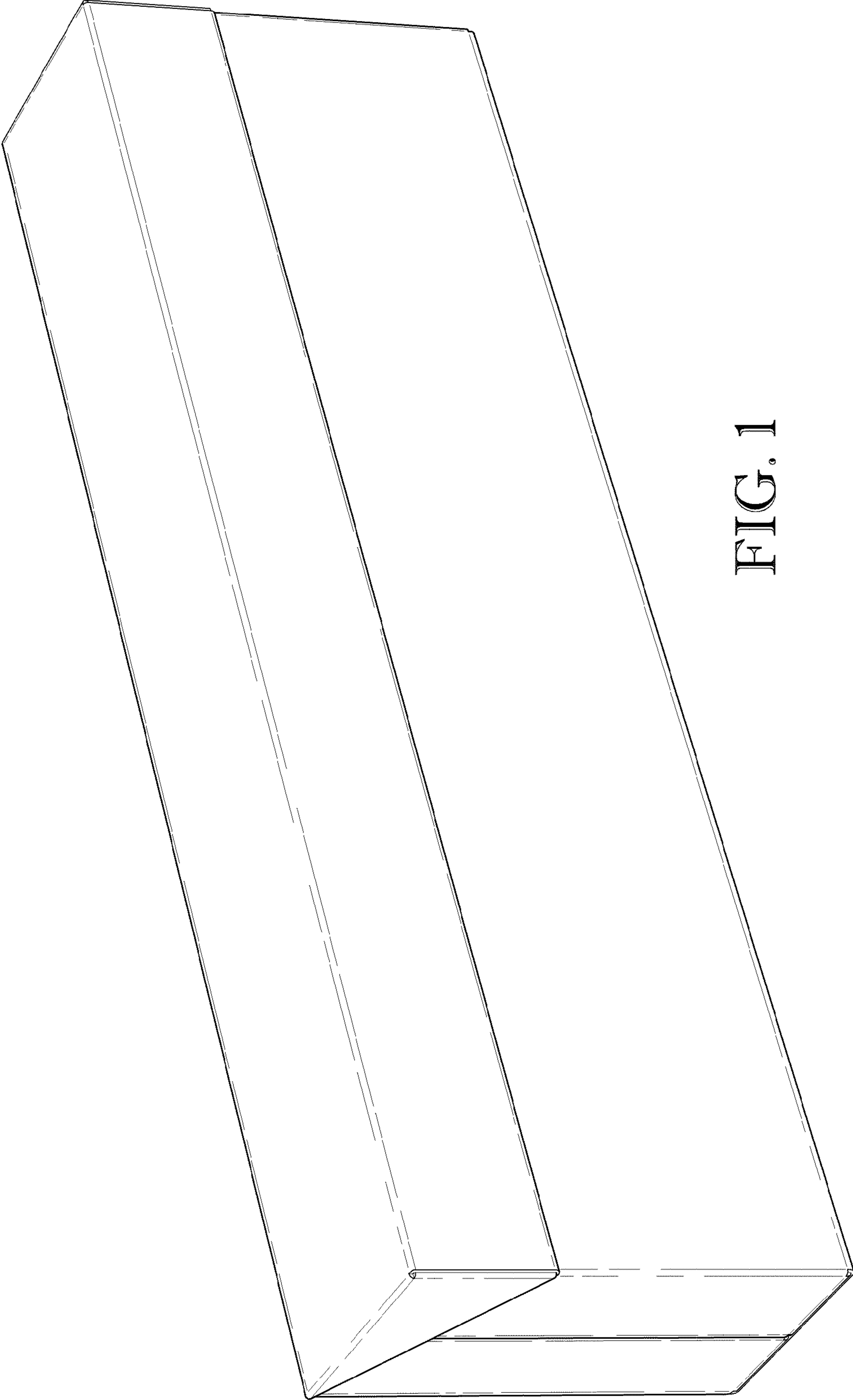

FIG. 1

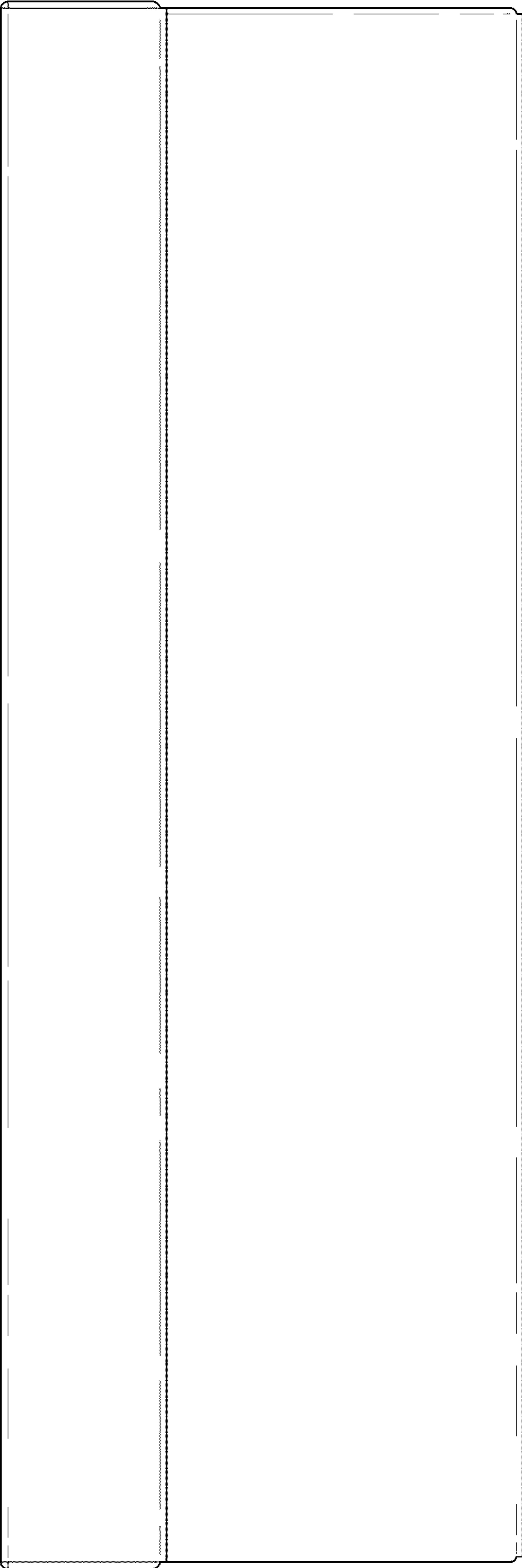

FIG. 2

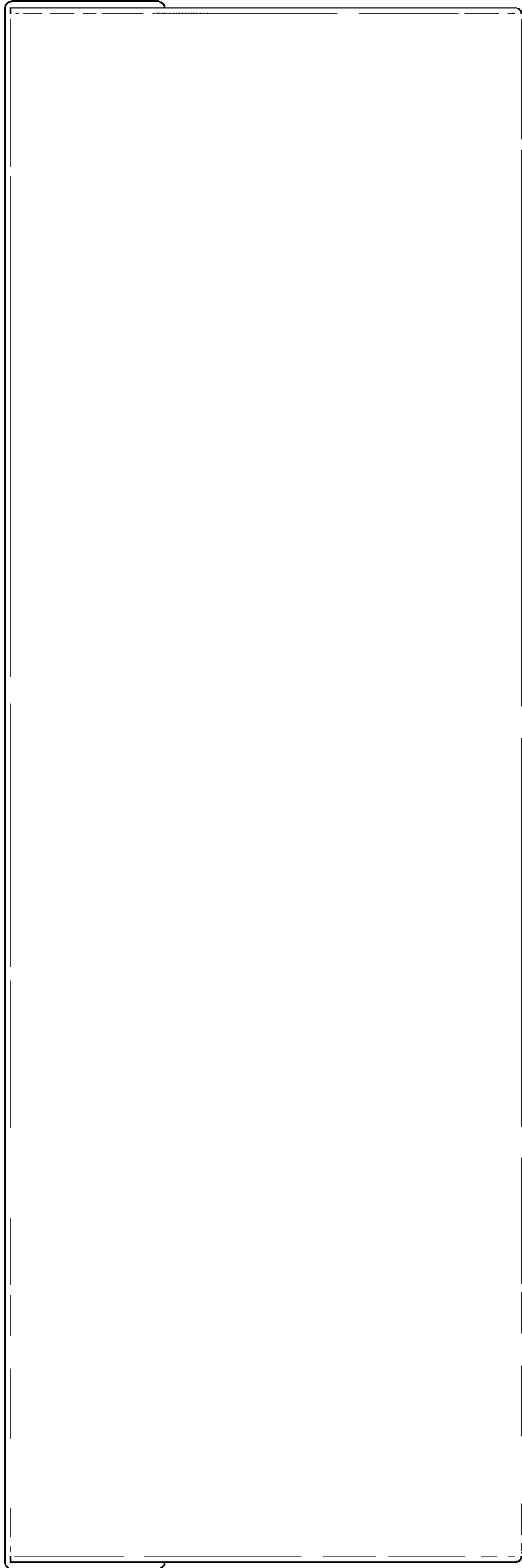

FIG. 3

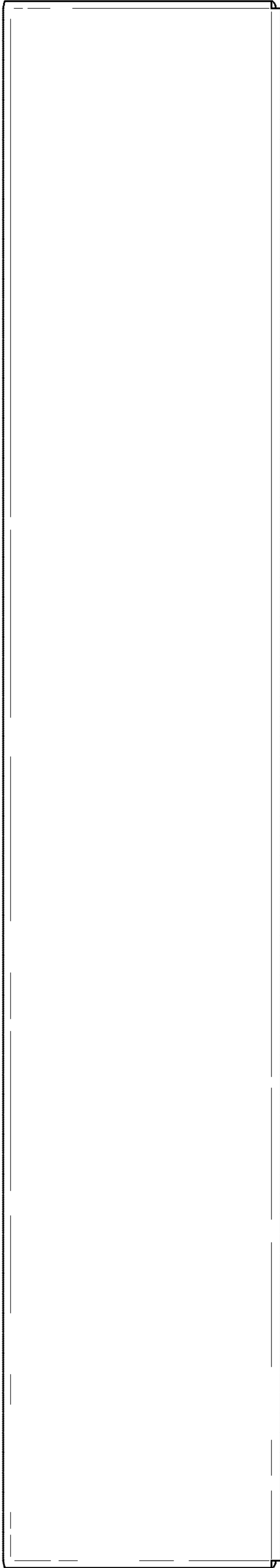

FIG. 4

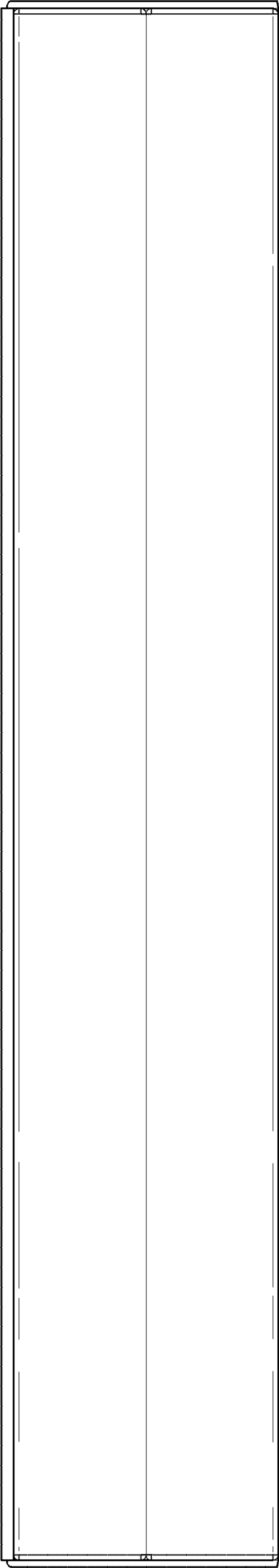

FIG. 5

FIG. 6

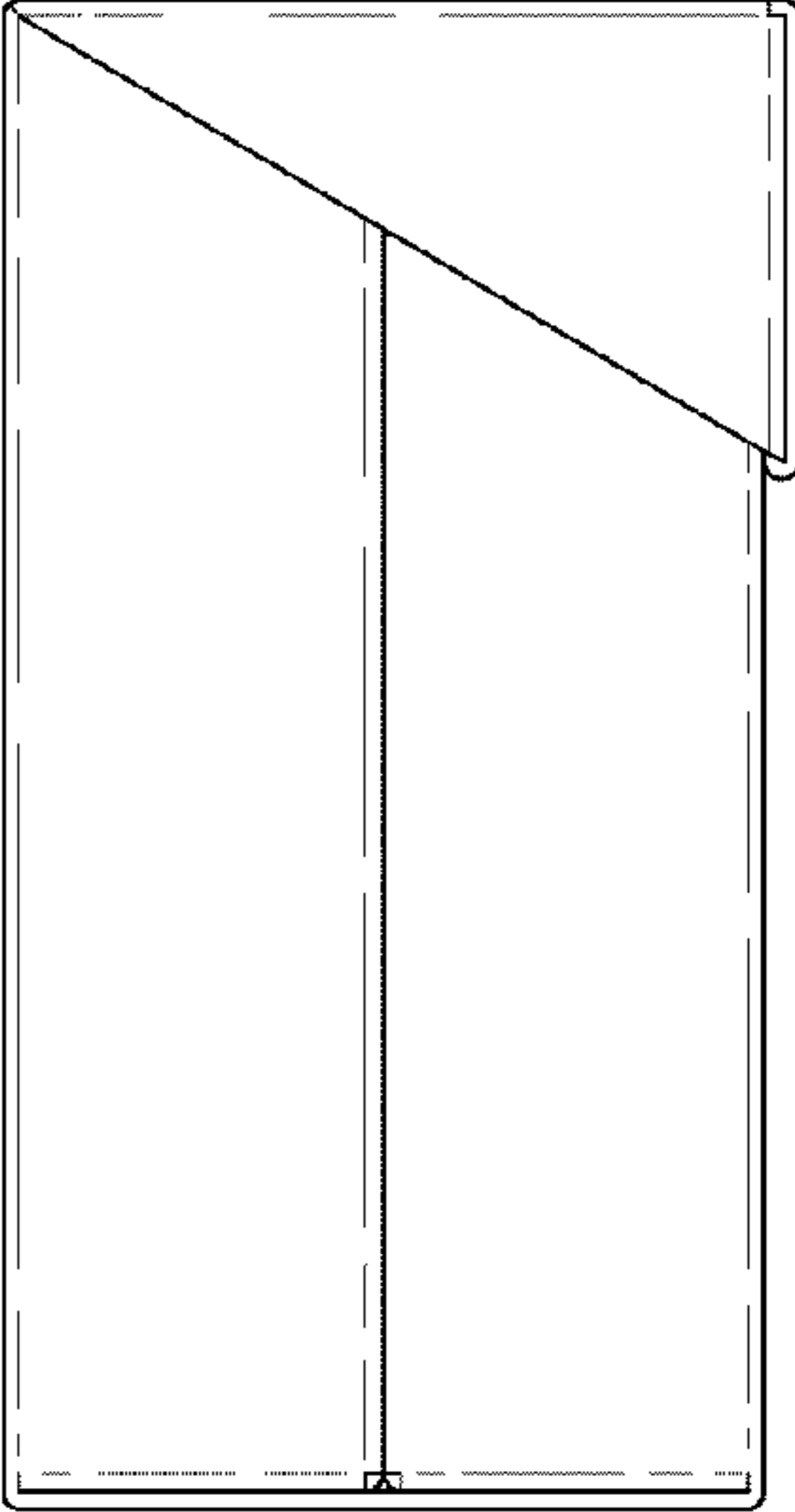

FIG. 7

