



US00D645725S

(12) **United States Design Patent**  
**Katz et al.**

(10) **Patent No.:** **US D645,725 S**

(45) **Date of Patent:** **\*\* Sep. 27, 2011**

(54) **HINGE**

(75) Inventors: **Alexander S Katz**, Atlanta, GA (US);  
**Jeff Underwood**, Newnan, GA (US)

(73) Assignee: **Kason Industries, Inc.**, Newnan, GA  
(US)

(\*\*) Term: **14 Years**

(21) Appl. No.: **29/387,002**

(22) Filed: **Mar. 8, 2011**

(51) **LOC (9) Cl.** ..... **08-06**

(52) **U.S. Cl.** ..... **D8/327; D8/323**

(58) **Field of Classification Search** ..... D8/323,  
D8/328, 329, 324, 330, 325, 327, 331, 336,  
D8/353, 338, 334, 57; D16/334; D23/302,  
D23/303; D10/69; D3/903; 4/236, 240;  
16/309, 235, 275, 244, 379, 390, 430, 241,  
16/238, 245, 236, 243, 242, 385, 225, 250;  
248/682; 33/347, 365-390

See application file for complete search history.

(56) **References Cited**

**U.S. PATENT DOCUMENTS**

D23,506 S *	7/1894	Hart	.....	D8/327
D75,537 S *	6/1928	Winters et al.	.....	D8/329
D85,477 S *	11/1931	Katz	.....	D8/329
1,832,902 A *	11/1931	Holbrook	.....	16/392
D86,814 S *	4/1932	Tamaroff	.....	D8/329
D92,335 S *	5/1934	Brantingson	.....	D8/329
D92,447 S *	6/1934	Brantingson	.....	D8/329
D105,649 S *	8/1937	Carruthers	.....	D8/329
D111,157 S *	9/1938	Schrader	.....	D8/329
D154,132 S *	6/1949	Lounsbury	.....	D8/329
D161,650 S *	1/1951	Scovill	.....	D8/329
D173,025 S *	9/1954	Fritz	.....	D8/329
D255,868 S	7/1980	Berkowitz et al.		

D299,420 S *	1/1989	Takahashi	.....	D8/329
D302,104 S *	7/1989	Takahashi	.....	D8/329
D302,105 S *	7/1989	Takahashi	.....	D8/329
4,991,259 A	2/1991	Finkelstein et al.		
D348,205 S *	6/1994	Chen	.....	D8/331
D395,590 S	6/1998	Finkelstein		
D401,134 S	11/1998	Finkelstein		
D451,000 S *	11/2001	Karl	.....	D8/323
6,401,298 B1 *	6/2002	Lenz	.....	16/335
7,055,214 B1	6/2006	Finkelstein		
7,584,523 B1	9/2009	Finkelstein et al.		
D608,179 S *	1/2010	Tejszerski	.....	D8/327
7,870,642 B1	1/2011	Finkelstein et al.		
D637,060 S *	5/2011	Mitchell et al.	.....	D8/323

**OTHER PUBLICATIONS**

Kason Walk-in Hardware 2009 catalog pp. B-28 through B-47.

\* cited by examiner

*Primary Examiner* — Cynthia Underwood

(74) *Attorney, Agent, or Firm* — Baker Donelson; Dorian B. Kennedy

(57) **CLAIM**

The ornamental design for a hinge, as shown and described.

**DESCRIPTION**

FIG. 1 is a perspective view of a hinge showing our new design.

FIG. 2 is a left side view thereof.

FIG. 3 is a front view thereof.

FIG. 4 is a right side view thereof.

FIG. 5 is a top view thereof.

FIG. 6 is a bottom view thereof; and,

FIG. 7 is a rear view thereof.

The broken lines depict portions of the hinge that form no part of the claimed design.

**1 Claim, 4 Drawing Sheets**

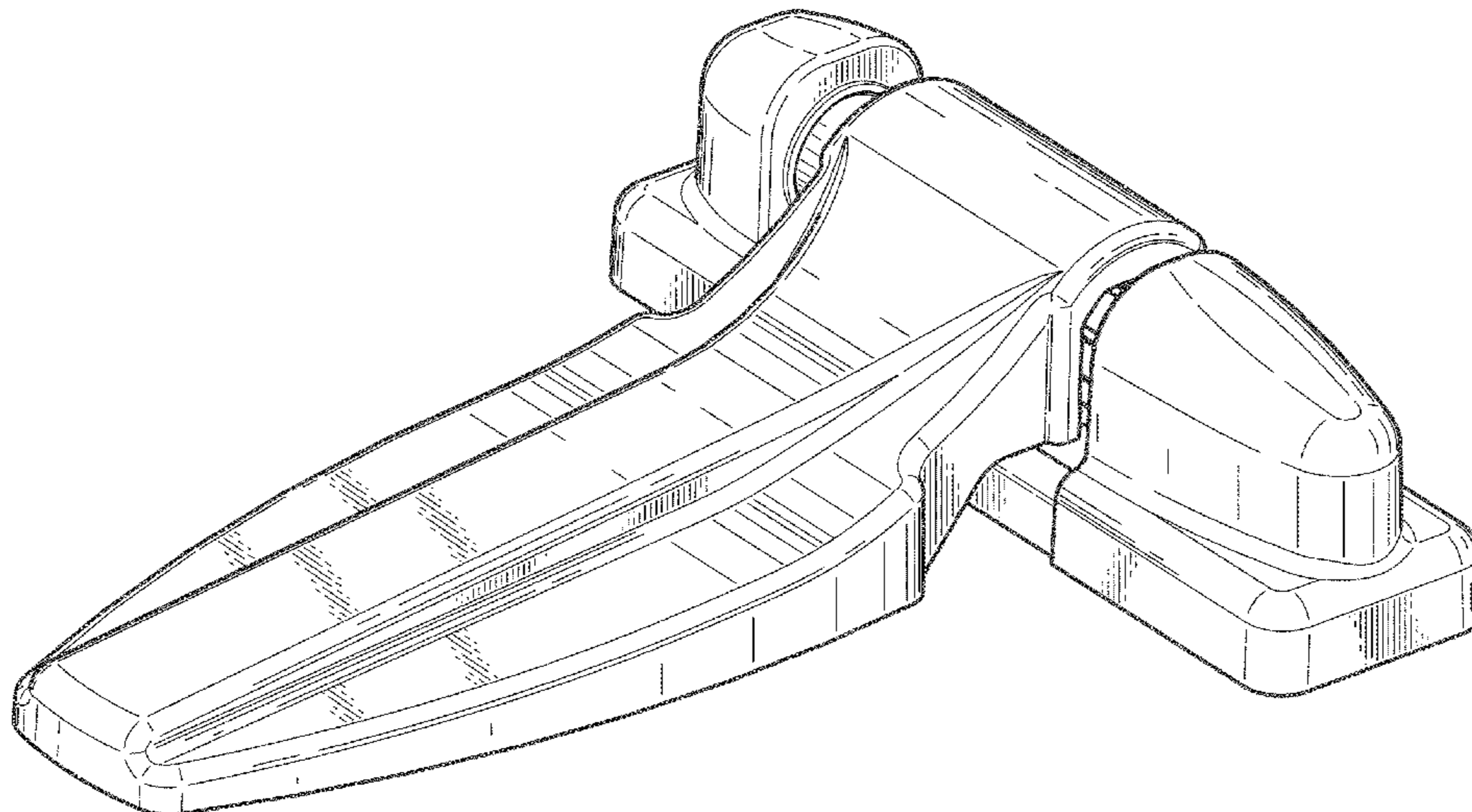

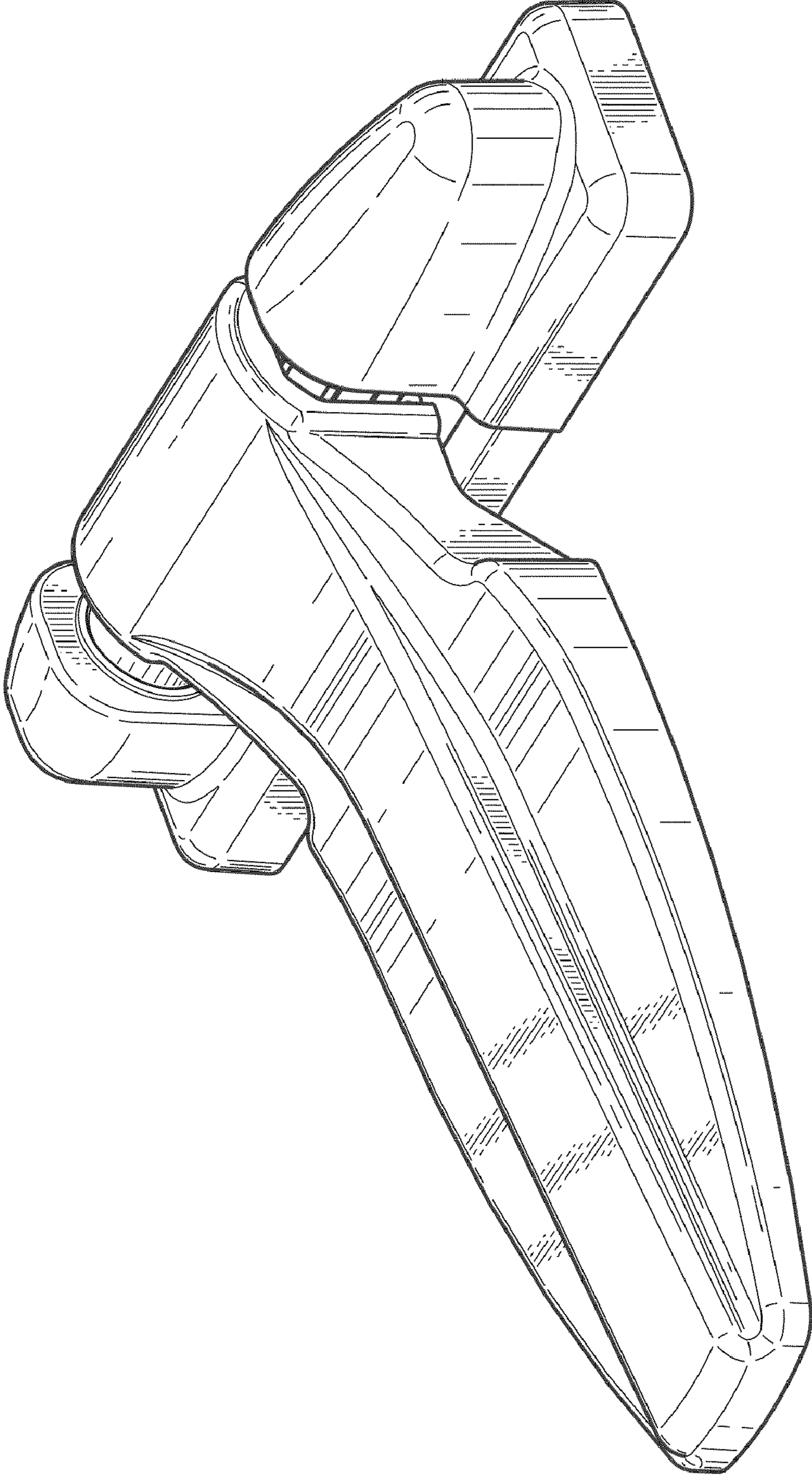

FIG. 1

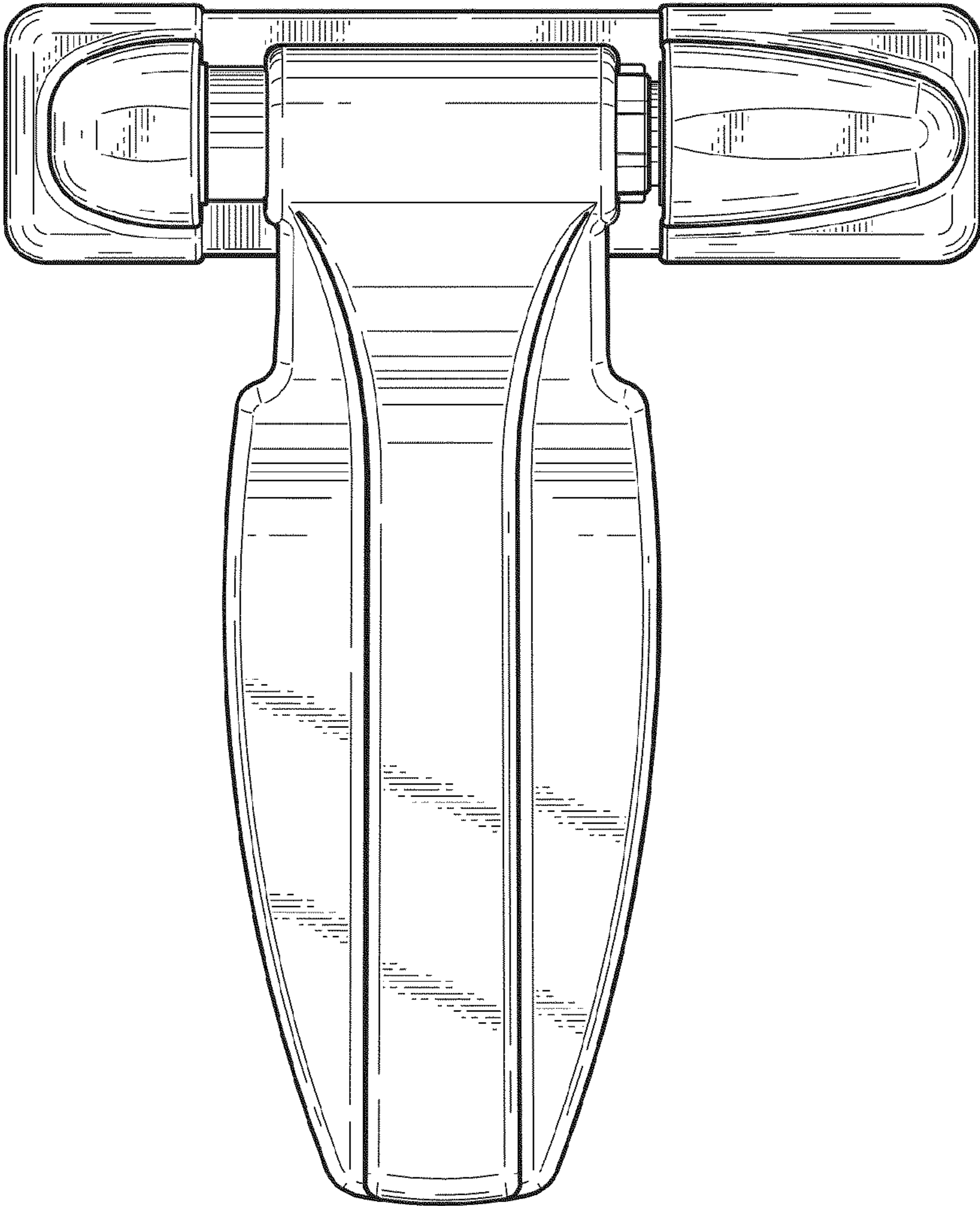

FIG. 3

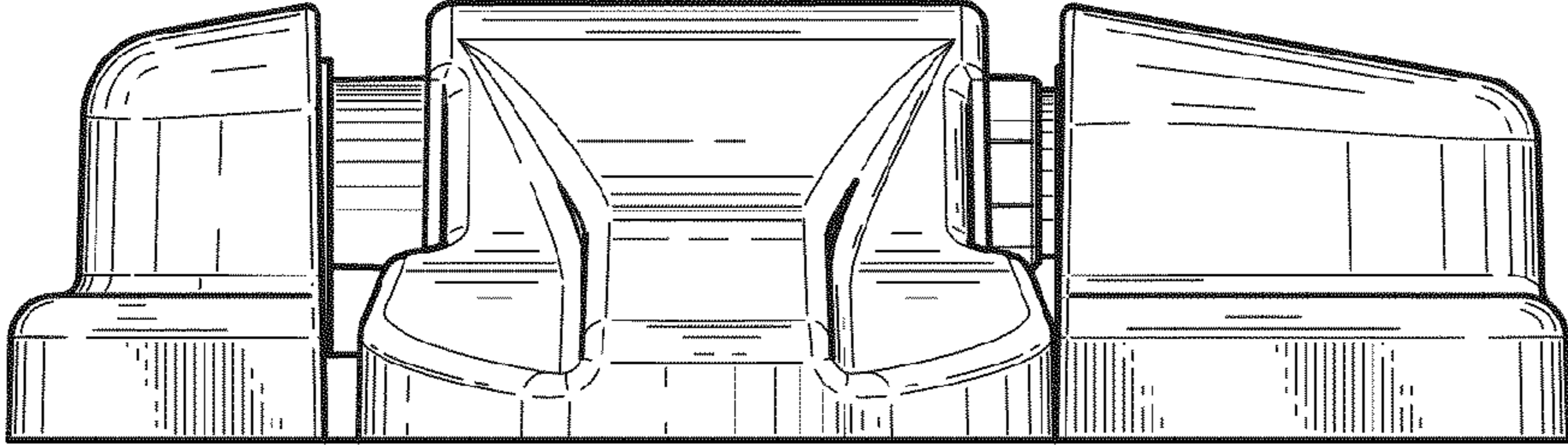

FIG. 2

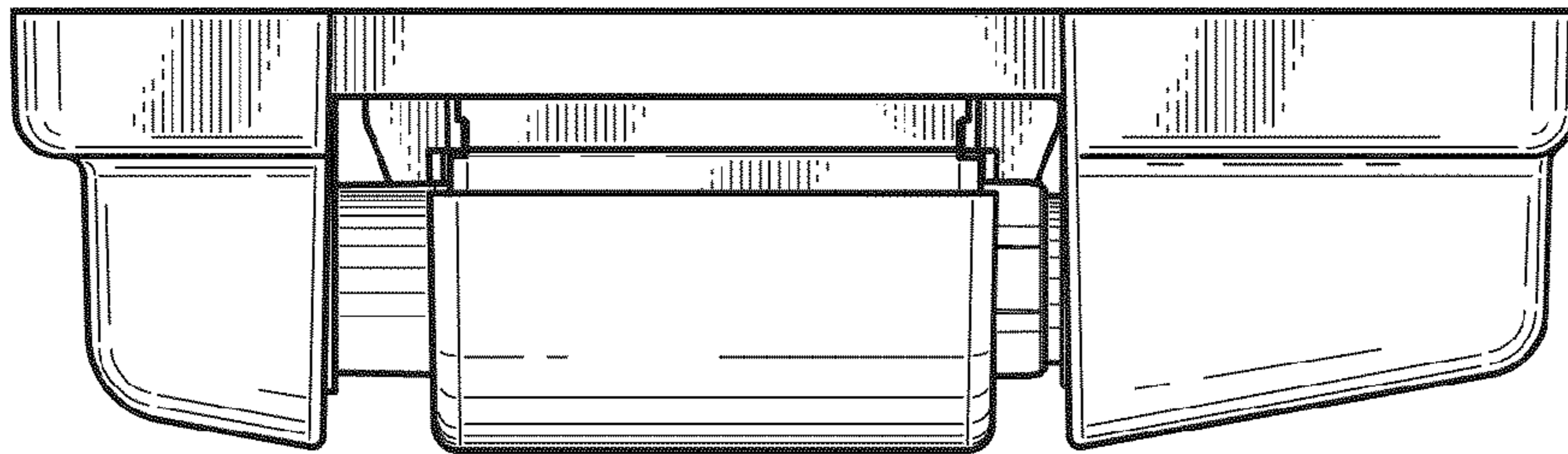

FIG. 4

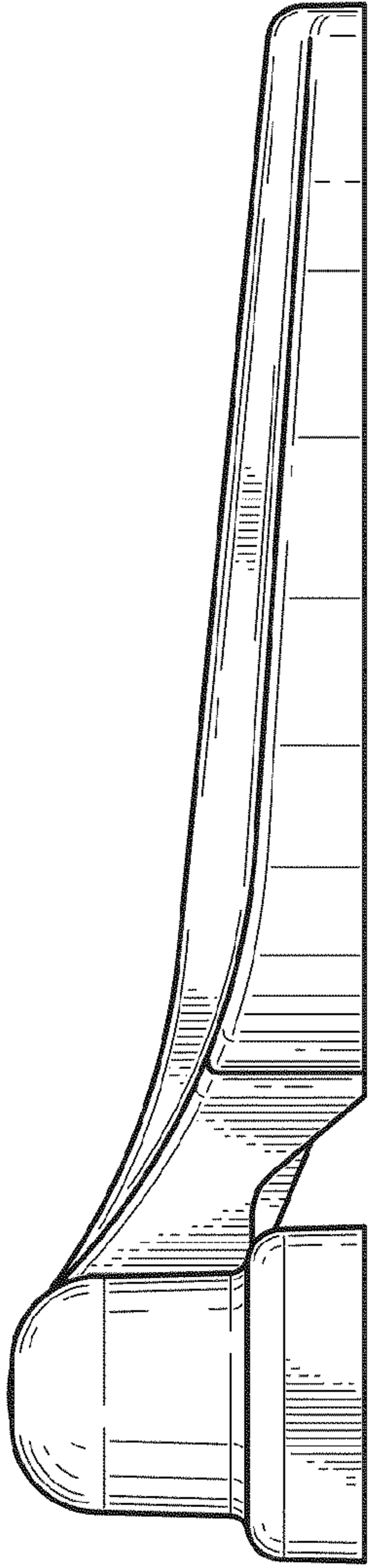

FIG. 5

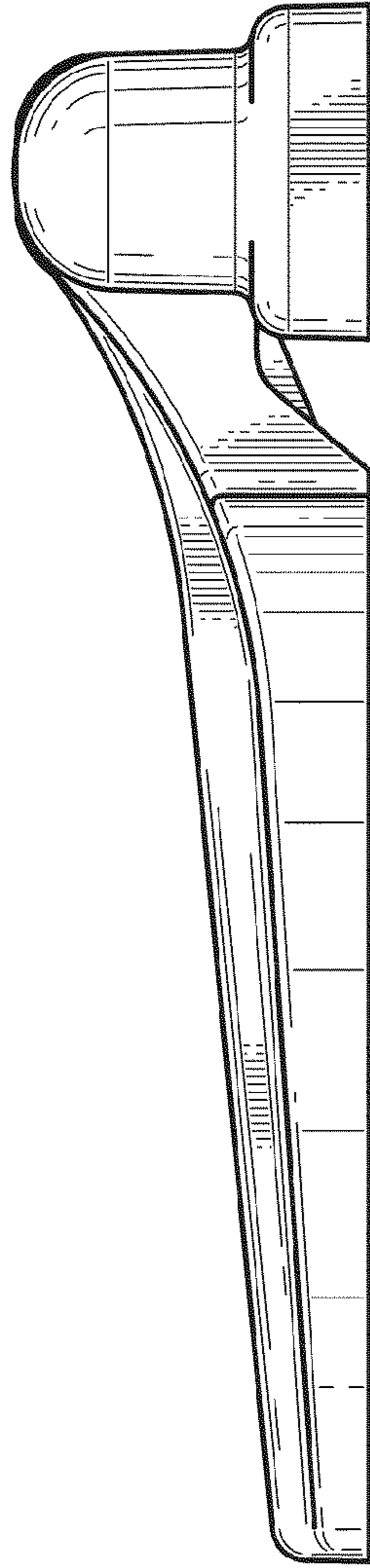
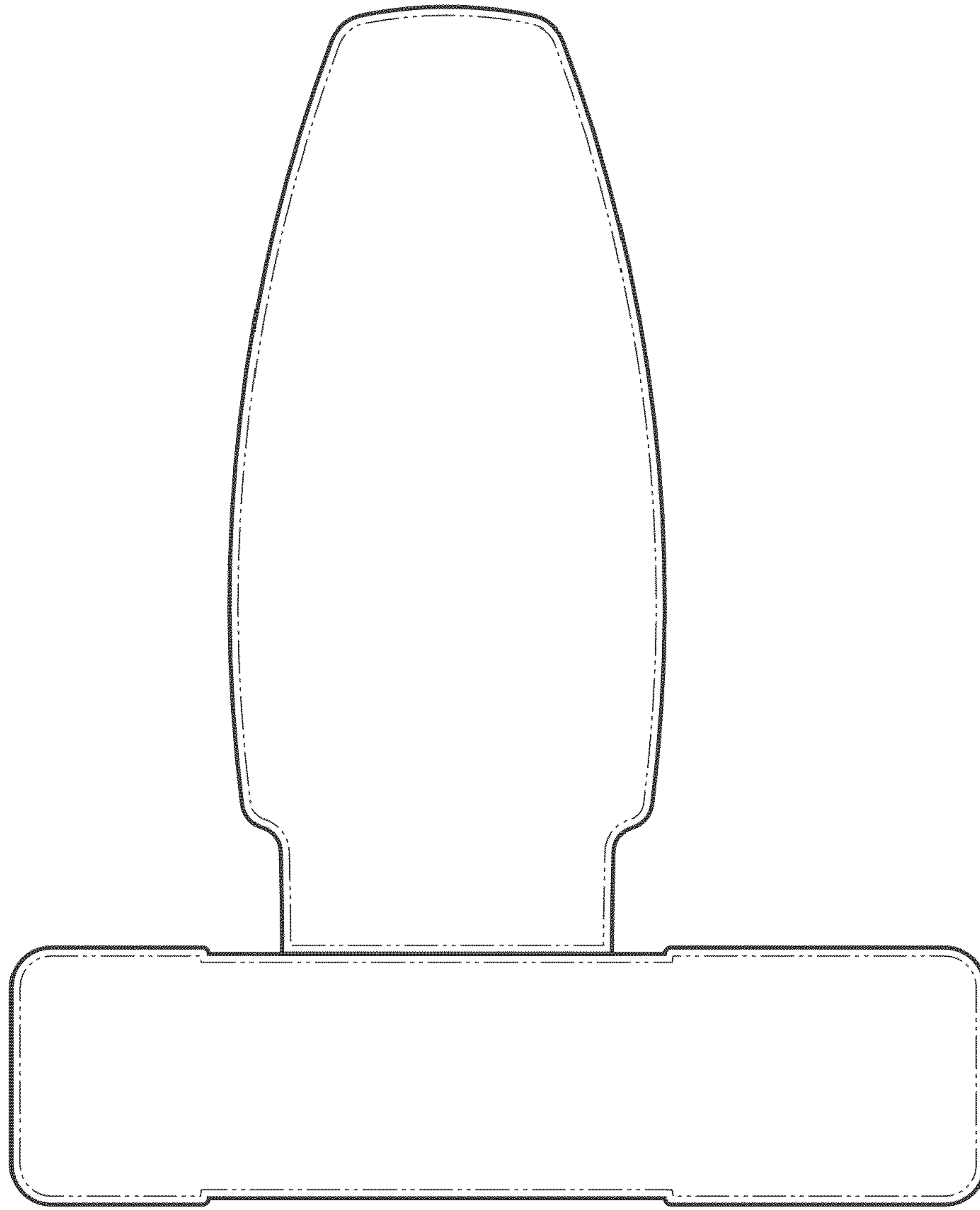

FIG. 6



**FIG. 7**