



US00D645718S

(12) **United States Design Patent**
Crystal et al.

(10) **Patent No.:** **US D645,718 S**

(45) **Date of Patent:** **** Sep. 27, 2011**

(54) **CUTTER**

(75) Inventors: **Jeremy Burton Crystal**, Springville, UT (US); **Jeffery V. Gubler**, Springville, UT (US); **Rebecca Seago**, Spanish Fork, UT (US)

(73) Assignee: **Provo Craft and Novelty, Inc.**, South Jordan, UT (US)

(**) Term: **14 Years**

(21) Appl. No.: **29/354,276**

(22) Filed: **Jan. 21, 2010**

(51) **LOC (9) Cl.** **08-03**

(52) **U.S. Cl.** **D8/98**

(58) **Field of Classification Search** D8/98,
D8/99, 102, 107; 30/2, 151, 162, 329, 335,
30/340; D19/35; 606/167; D24/147
See application file for complete search history.

(56) **References Cited**

U.S. PATENT DOCUMENTS

1,843,535	A *	2/1932	Arnold	30/2
D166,172	S *	3/1952	Bureau	D8/98
2,604,693	A *	7/1952	Schierstead	30/152
2,659,143	A *	11/1953	Baker	30/317
2,847,758	A *	8/1958	Kozan	30/164.9
3,080,653	A *	3/1963	Dolin	30/317
D240,499	S *	7/1976	Souders	D8/98
D258,310	S *	2/1981	LaHaye	D24/147
D263,020	S *	2/1982	Rau, III	D8/99
D263,445	S *	3/1982	Gordin et al.	D8/107
4,400,878	A *	8/1983	Vaudreuil	30/329
D271,370	S *	11/1983	San Antonio	D8/14
D285,285	S *	8/1986	Soyama	D8/98
D313,540	S *	1/1991	Toor et al.	D8/98

5,175,934	A *	1/1993	Chao	30/329
D383,962	S *	9/1997	Daley et al.	D8/98
5,665,099	A *	9/1997	Pilo et al.	606/167
D508,838	S *	8/2005	Meizlish et al.	D8/98
D514,419	S *	2/2006	Henriksen	D8/98
D565,917	S *	4/2008	Peterson et al.	D8/98
D589,774	S *	4/2009	Haraguchi et al.	D8/98
D589,775	S *	4/2009	Haraguchi et al.	D8/98
2008/0196253	A1 *	8/2008	Ezra et al.	30/124
2010/0005665	A1 *	1/2010	Elliott et al.	30/123
2010/0024221	A1 *	2/2010	Hernandez	30/296.1
2010/0107418	A1 *	5/2010	Chen	30/143

OTHER PUBLICATIONS

<http://www.amazon.com/Hobby-Exacto-Knife-Blades-13-Piece/dp/B001CWHHW4>. Downloaded May 22, 2011.*

* cited by examiner

Primary Examiner — Phillip S Hyder

Assistant Examiner — Roselynn Cody

(74) *Attorney, Agent, or Firm* — Honigman Miller Schwartz and Cohn LLP

(57) **CLAIM**

The ornamental design for a cutter, as shown and described.

DESCRIPTION

FIG. 1 is a perspective view of the cutter of the present invention;

FIG. 2 is a front elevational view thereof;

FIG. 3 is a rear elevational view thereof;

FIG. 4 is a right side elevational view thereof;

FIG. 5 is a left side elevational view thereof;

FIG. 6 is a top view thereof; and,

FIG. 7 is a bottom view thereof.

1 Claim, 4 Drawing Sheets

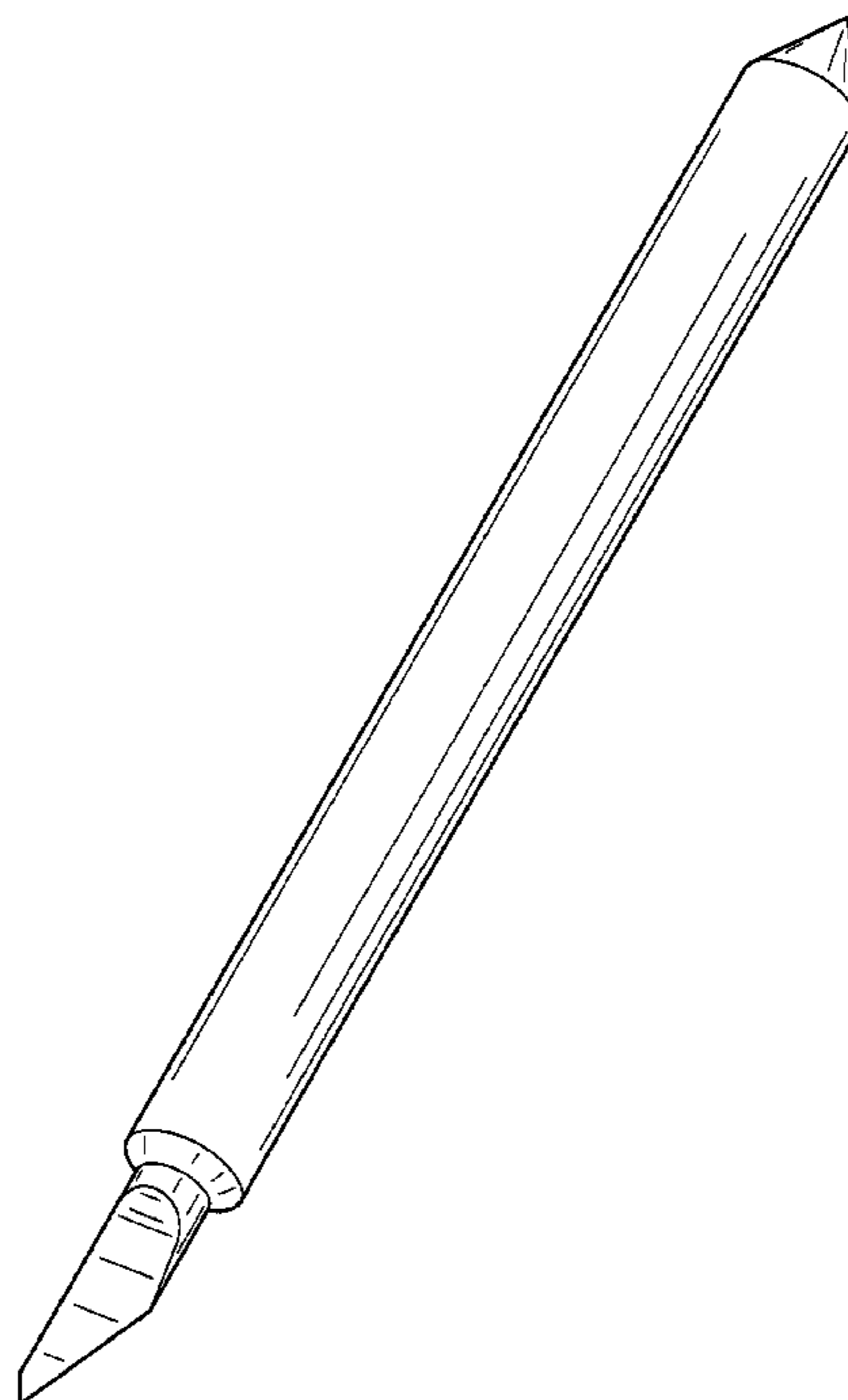

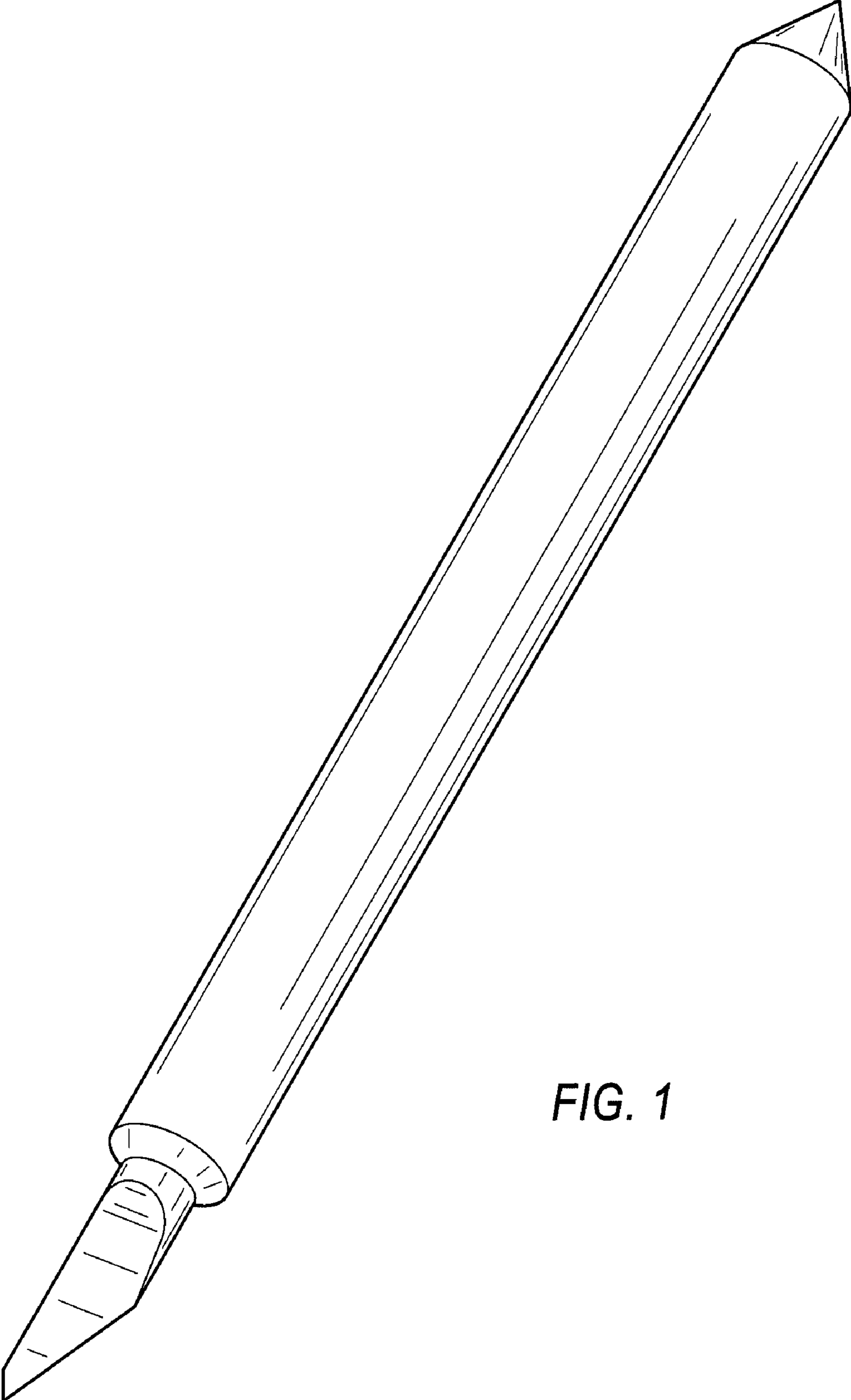

FIG. 1

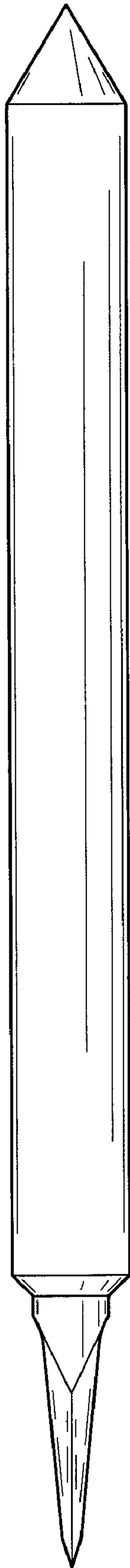

FIG. 2

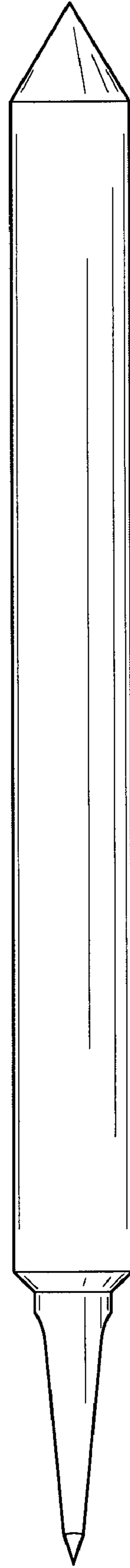

FIG. 3

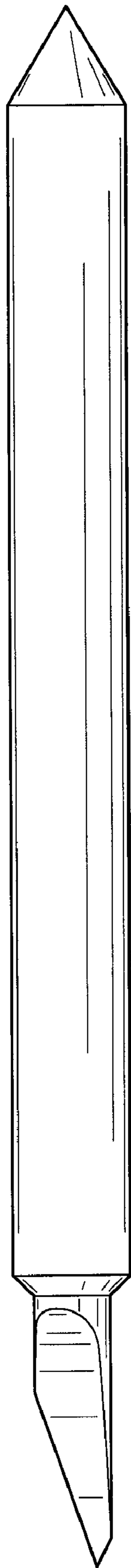

FIG. 4

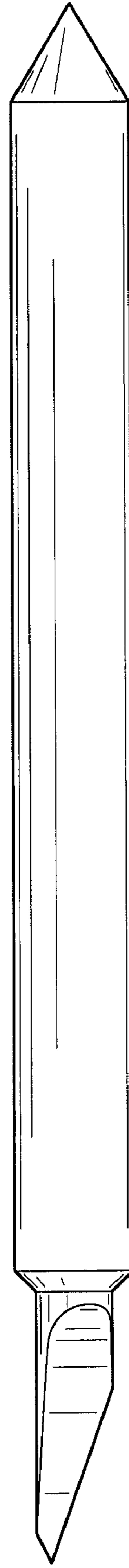

FIG. 5

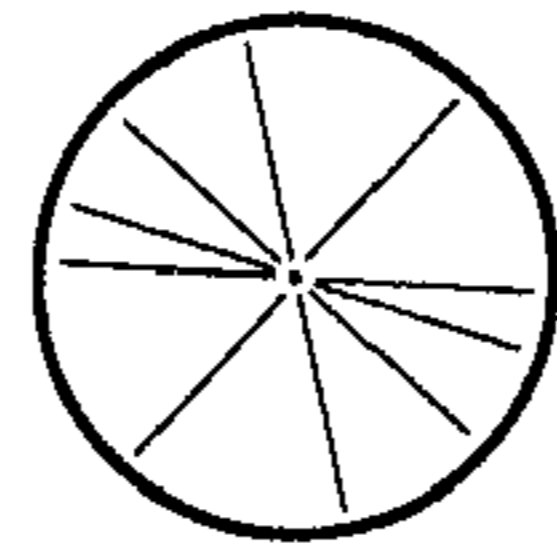

FIG. 6

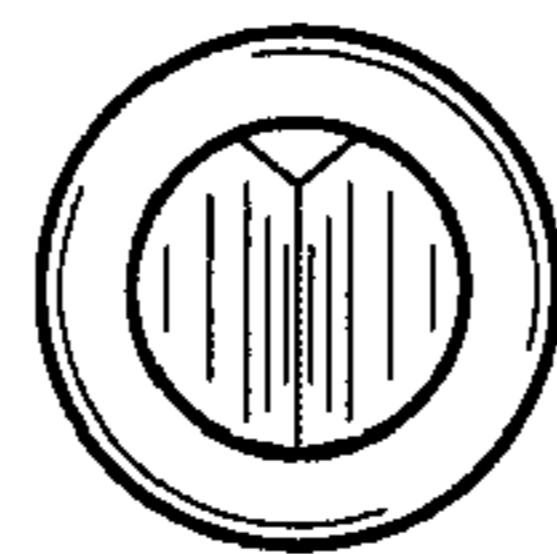

FIG. 7