



US00D645562S

(12) **United States Design Patent**
Thai

(10) **Patent No.:** **US D645,562 S**

(45) **Date of Patent:** **** Sep. 20, 2011**

(54) **GUIDED DENTAL WEDGE**

(76) Inventor: **Hung M. Thai**, San Jose, CA (US)

(**) Term: **14 Years**

(21) Appl. No.: **29/378,699**

(22) Filed: **Nov. 8, 2010**

(51) **LOC (9) Cl.** **24-02**

(52) **U.S. Cl.** **D24/152; D24/140; D24/147**

(58) **Field of Classification Search** **D24/140,**
D24/147, 152, 176; D21/364, 368, 386;
132/329; 433/3, 25, 72, 141-144, 149, 148,
433/229

See application file for complete search history.

(56) **References Cited**

U.S. PATENT DOCUMENTS

3,775,848	A *	12/1973	Barnett	132/329
3,890,714	A *	6/1975	Gores	433/149
4,197,648	A *	4/1980	Aichinger	433/3
4,715,816	A *	12/1987	Mogelof	433/149
D439,667	S *	3/2001	Brown	D24/152

6,234,793	B1 *	5/2001	Brattesani et al.	433/39
6,402,514	B1 *	6/2002	Fischer et al.	433/149
7,007,328	B1 *	3/2006	Bailey	5/632
7,223,101	B2 *	5/2007	Garrison et al.	433/149
7,425,130	B2 *	9/2008	Schaffner et al.	433/149

* cited by examiner

Primary Examiner — Ian Simmons

Assistant Examiner — Wan Laymon

(57) **CLAIM**

The ornamental design for a guided dental wedge, as shown and described.

DESCRIPTION

FIG. 1 is a perspective view of a guided dental wedge showing my new design;

FIG. 2 is a side view (opposite side view is mirror image) thereof;

FIG. 3 is a back view thereof;

FIG. 4 is a front view thereof;

FIG. 5 is a top view thereof; and,

FIG. 6 is a bottom view thereof.

1 Claim, 2 Drawing Sheets

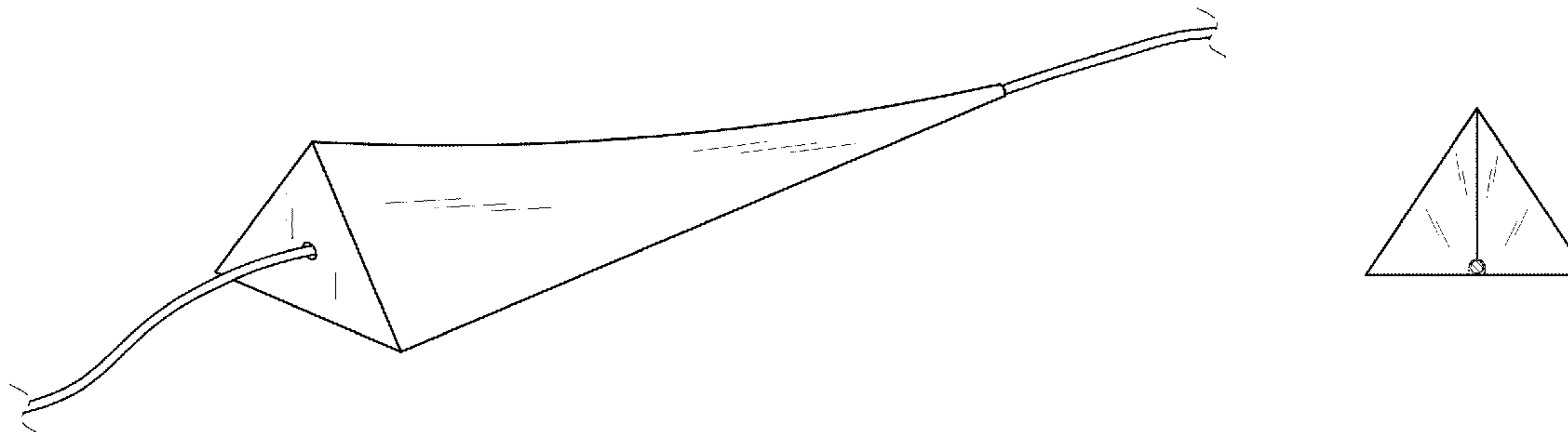

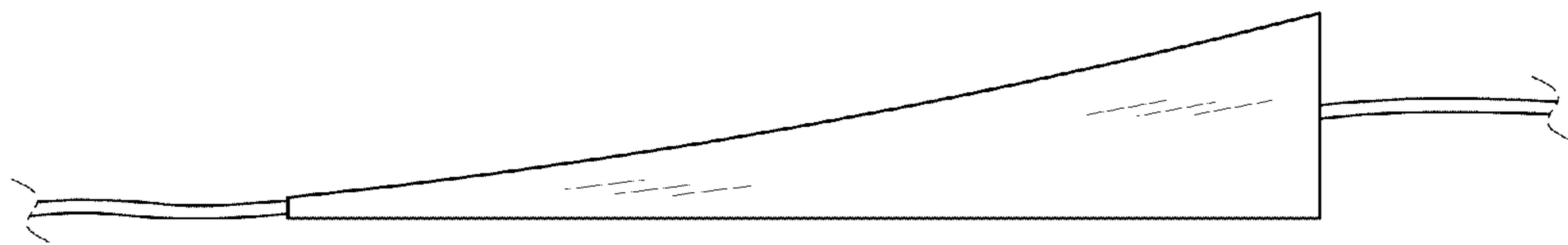
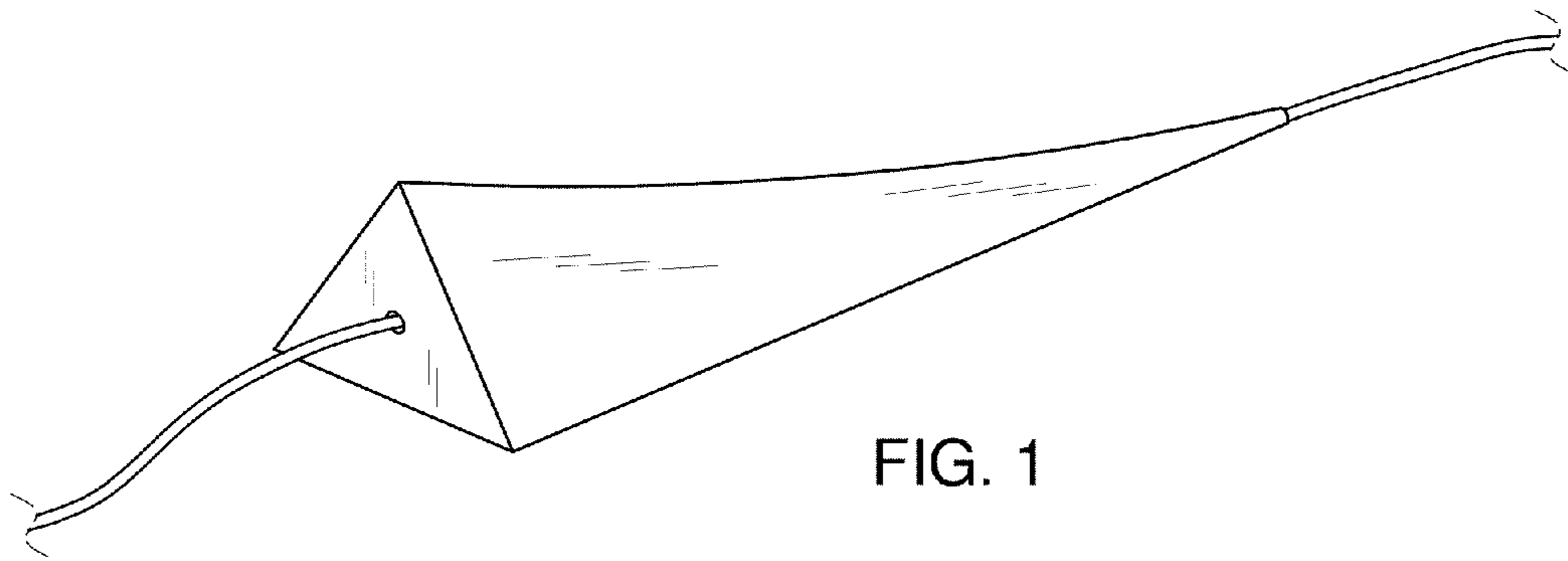

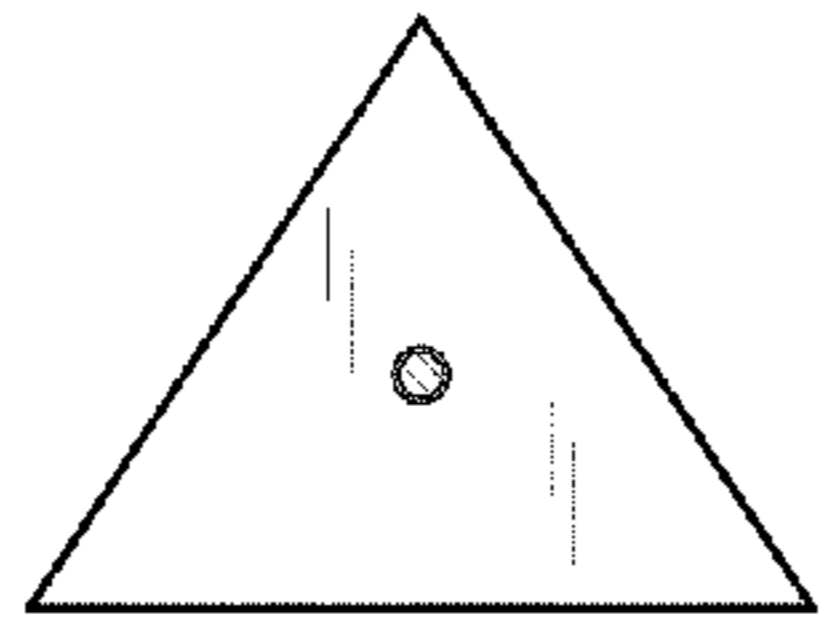

FIG. 3

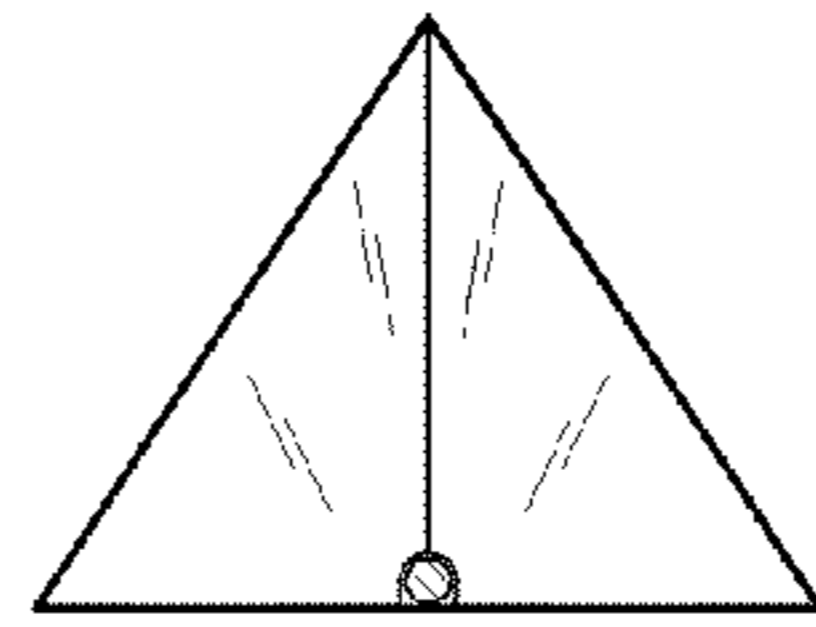

FIG. 4

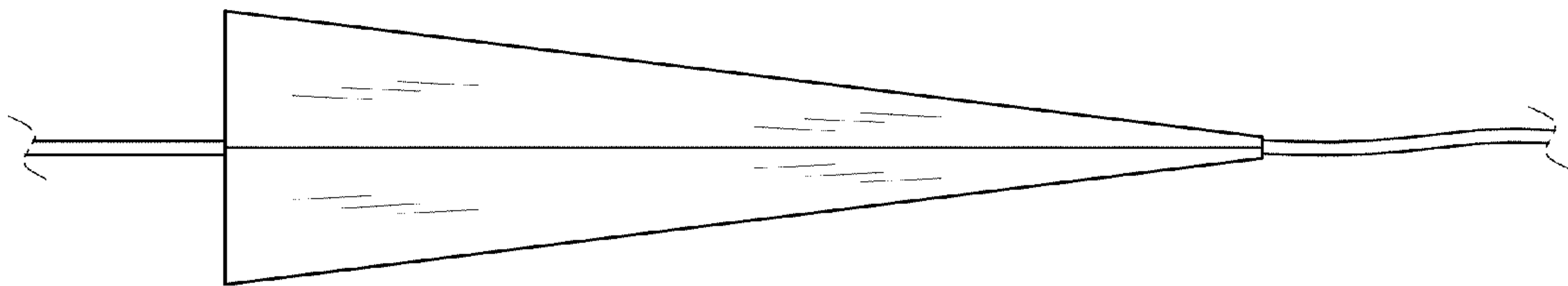

FIG. 5

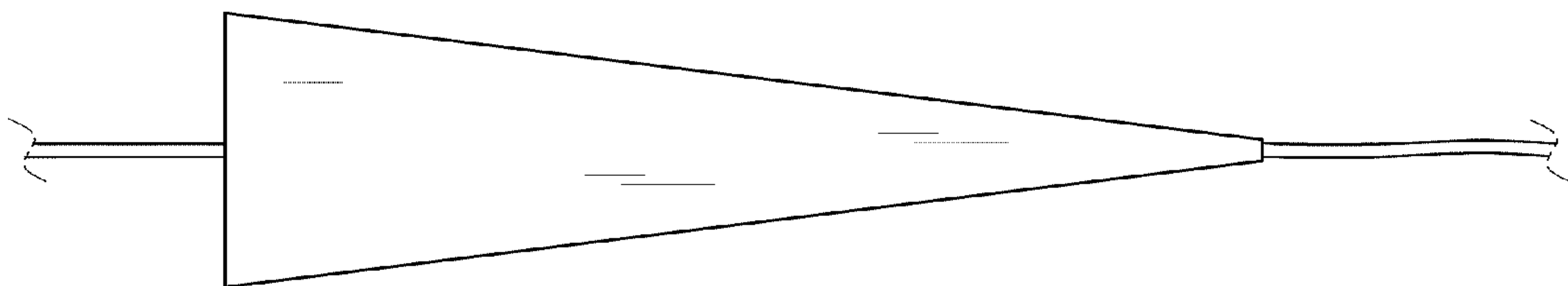

FIG. 6