



US00D645445S

(12) **United States Design Patent**
Kolton

(10) **Patent No.:** **US D645,445 S**

(45) **Date of Patent:** **** Sep. 20, 2011**

(54) **HEADPHONE ASSEMBLY**

(76) **Inventor:** **Timothy Val Kolton**, Los Angeles, CA
(US)

(**) **Term:** **14 Years**

(21) **Appl. No.:** **29/379,683**

(22) **Filed:** **Nov. 23, 2010**

(51) **LOC (9) Cl.** **14-01**

(52) **U.S. Cl.** **D14/205**

(58) **Field of Classification Search** D14/205,
D14/206, 223; 181/129, 130, 135; 379/430,
379/433.01; 381/380, 381; 455/90.3, 575.1;
D29/112; 2/209

See application file for complete search history.

(56) **References Cited**

U.S. PATENT DOCUMENTS

D337,115 S *	7/1993	Yamazaki et al.	D14/205
D491,163 S *	6/2004	Green	D14/205
D541,255 S *	4/2007	Taylor et al.	D14/205
D594,847 S *	6/2009	Suzuki	D14/205
D603,370 S *	11/2009	Suzuki	D14/205
D613,266 S *	4/2010	Barry et al.	D14/205
D616,865 S *	6/2010	Marchand et al.	D14/205

D617,770 S *	6/2010	Sanguinetti et al.	D14/205
D625,703 S *	10/2010	Kolton	D14/205
D632,667 S *	2/2011	Martin	D14/205
D637,579 S *	5/2011	Hamaura et al.	D14/205
D638,397 S *	5/2011	McManigal	D14/205

* cited by examiner

Primary Examiner — Paula Greene

(74) *Attorney, Agent, or Firm* — Edwin Tarver; Lauson & Tarver LLP

(57) **CLAIM**

The ornamental design for a headphone assembly, as shown and described.

DESCRIPTION

FIG. 1 is a perspective view of a headphone assembly showing my new design.

FIG. 2 is a bottom perspective view thereof.

FIG. 3 is a left side view thereof.

FIG. 4 is a right side view thereof.

FIG. 5 is a front view thereof.

FIG. 6 is a rear view thereof; and,

FIG. 7 is a top view thereof.

Portions of the drawings shown in dashed line are for illustrative purposes only, and form no part of the claimed design.

1 Claim, 6 Drawing Sheets

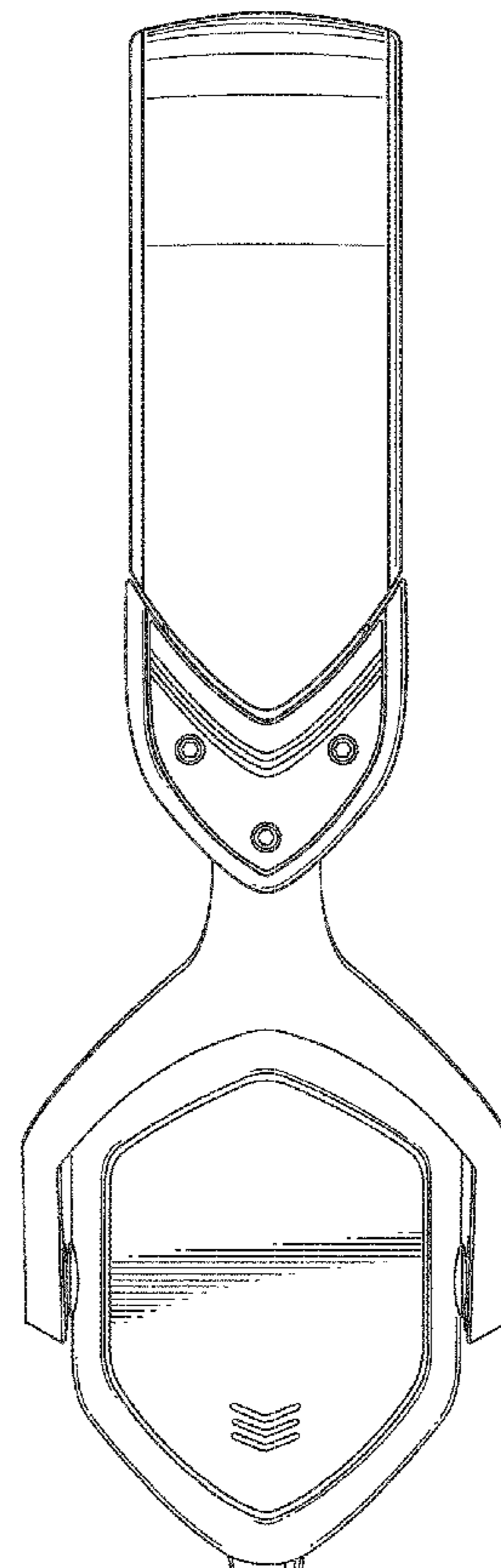
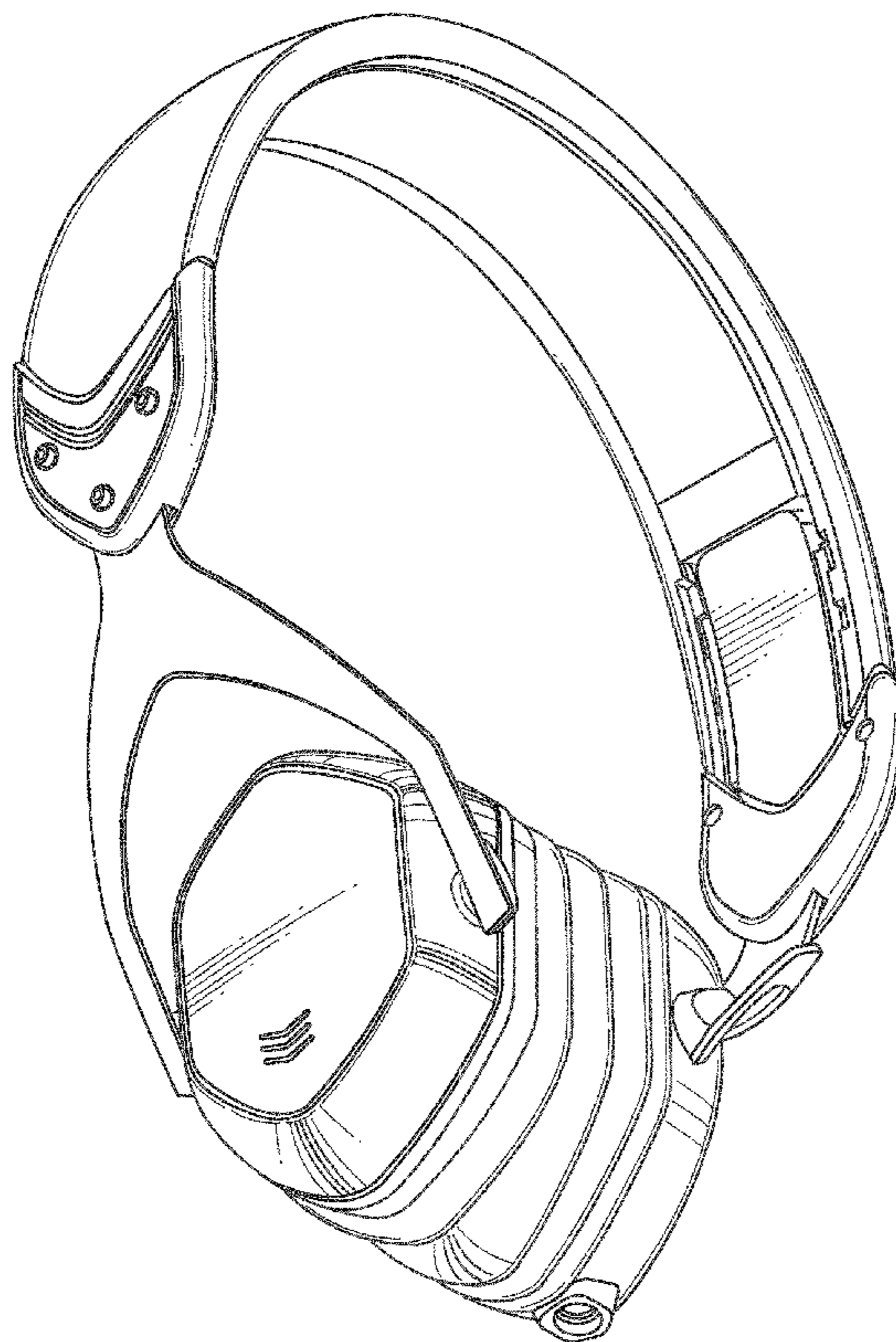

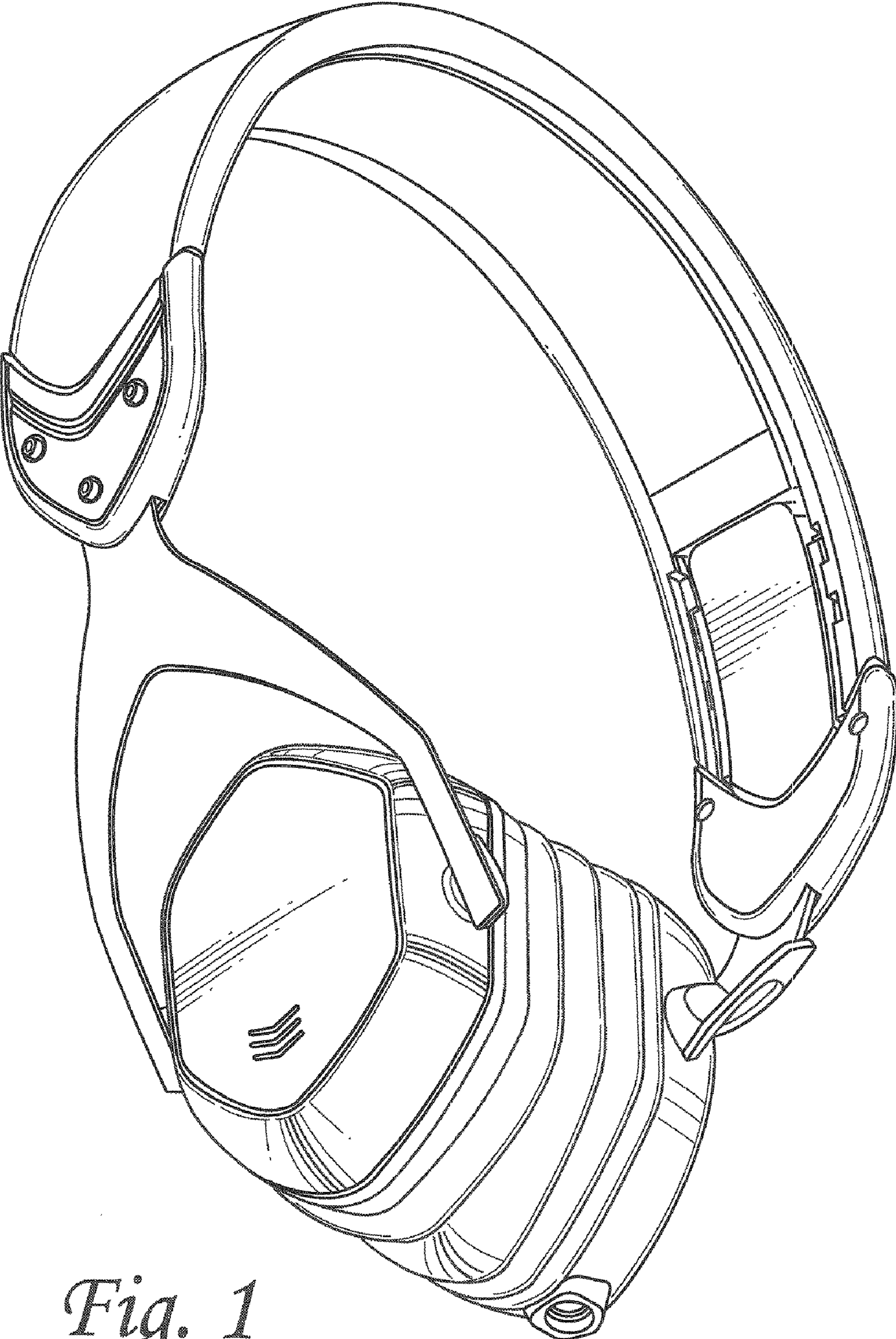

Fig. 1

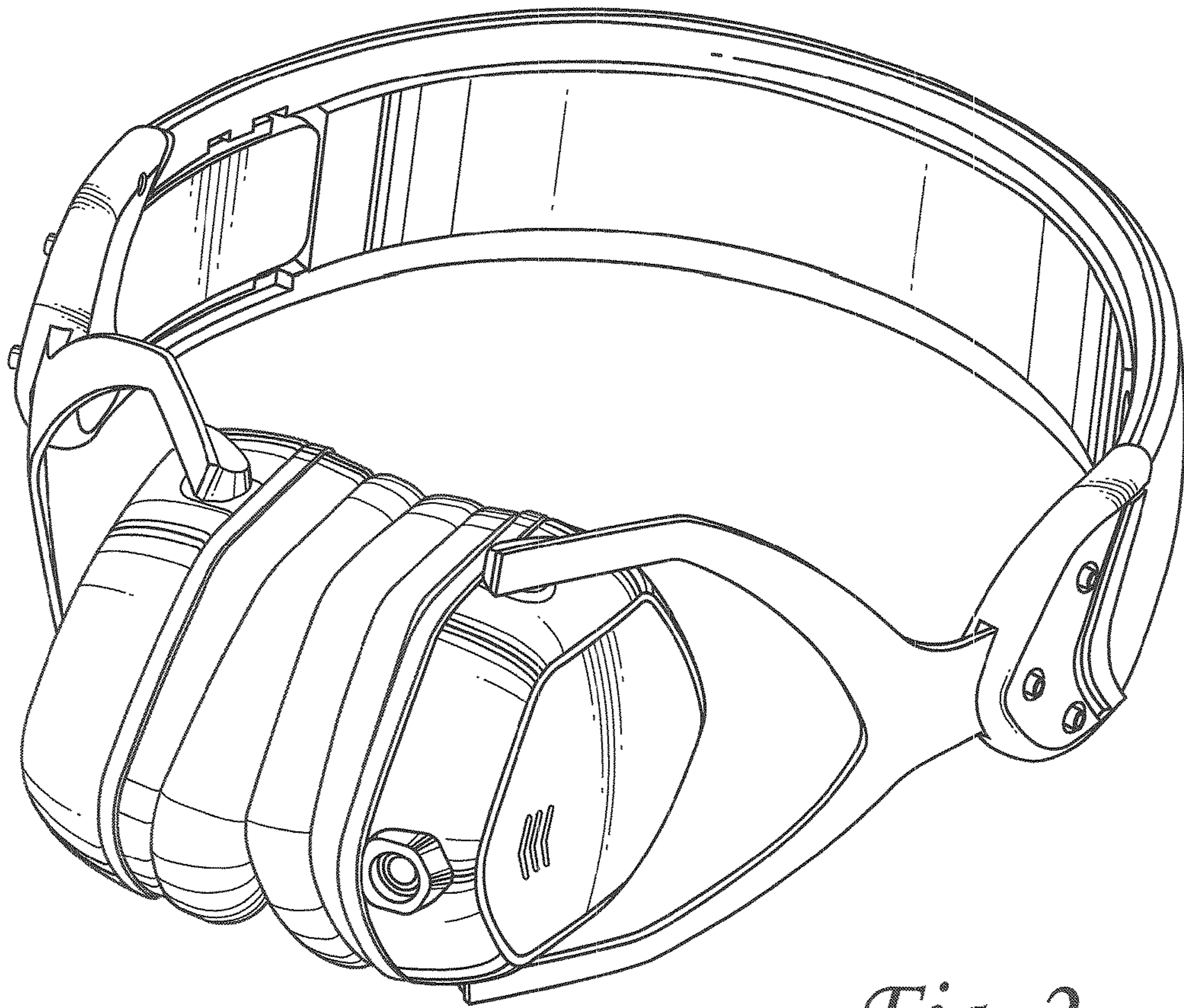

Fig. 2

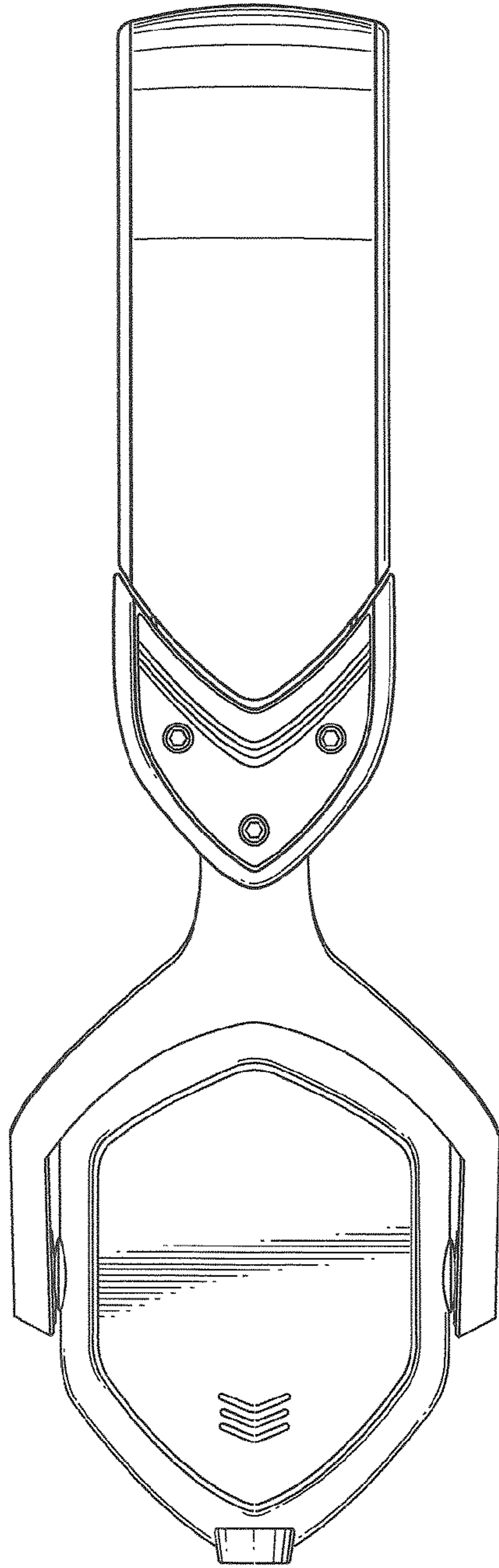
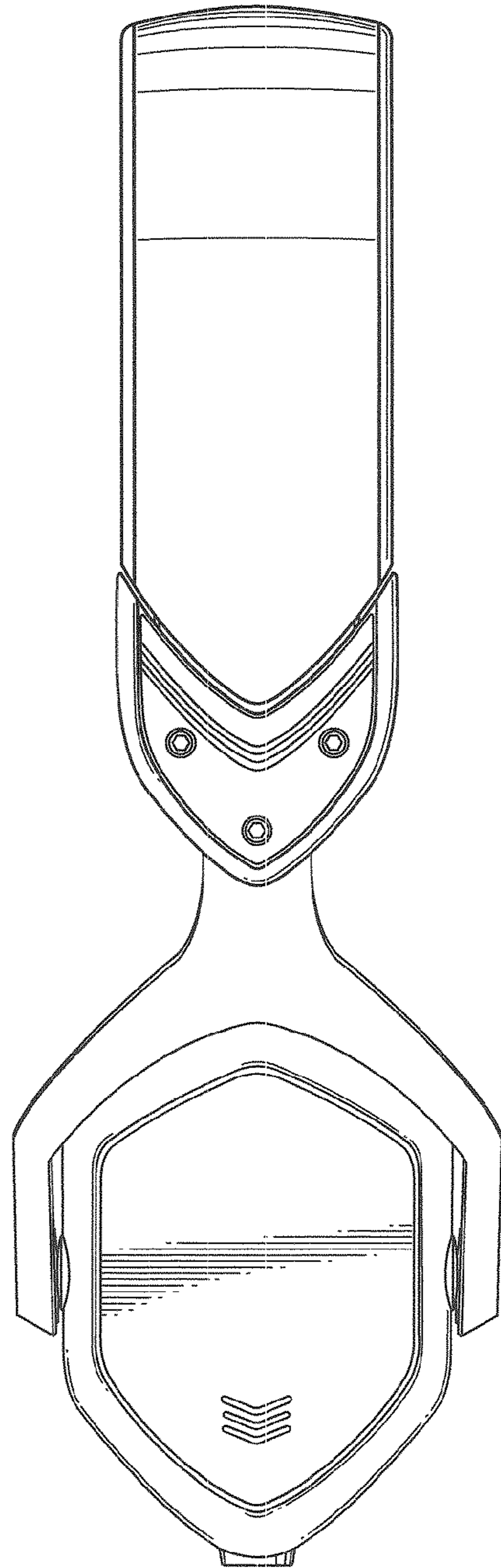

Fig. 3

Fig. 4



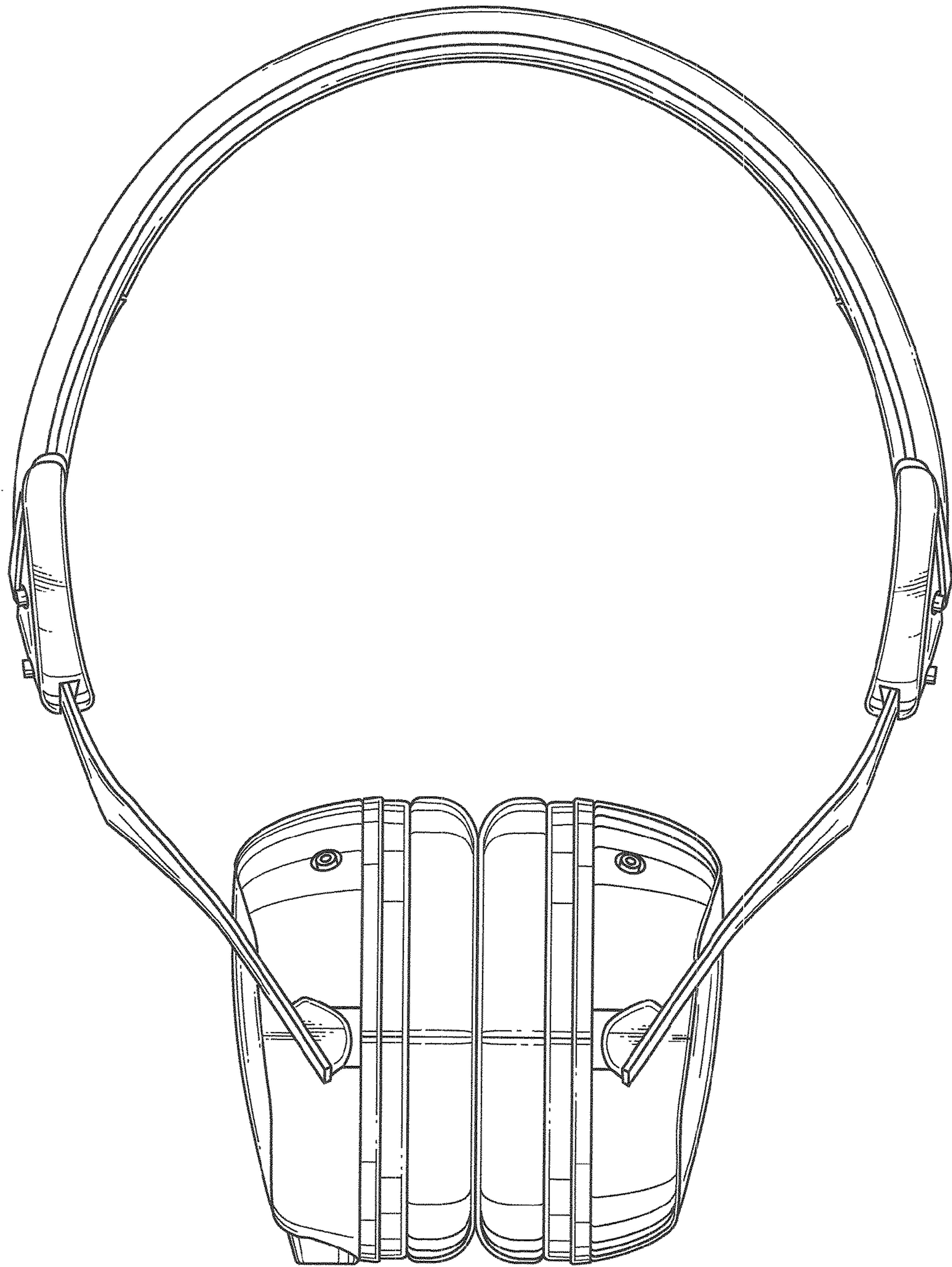

Fig. 5

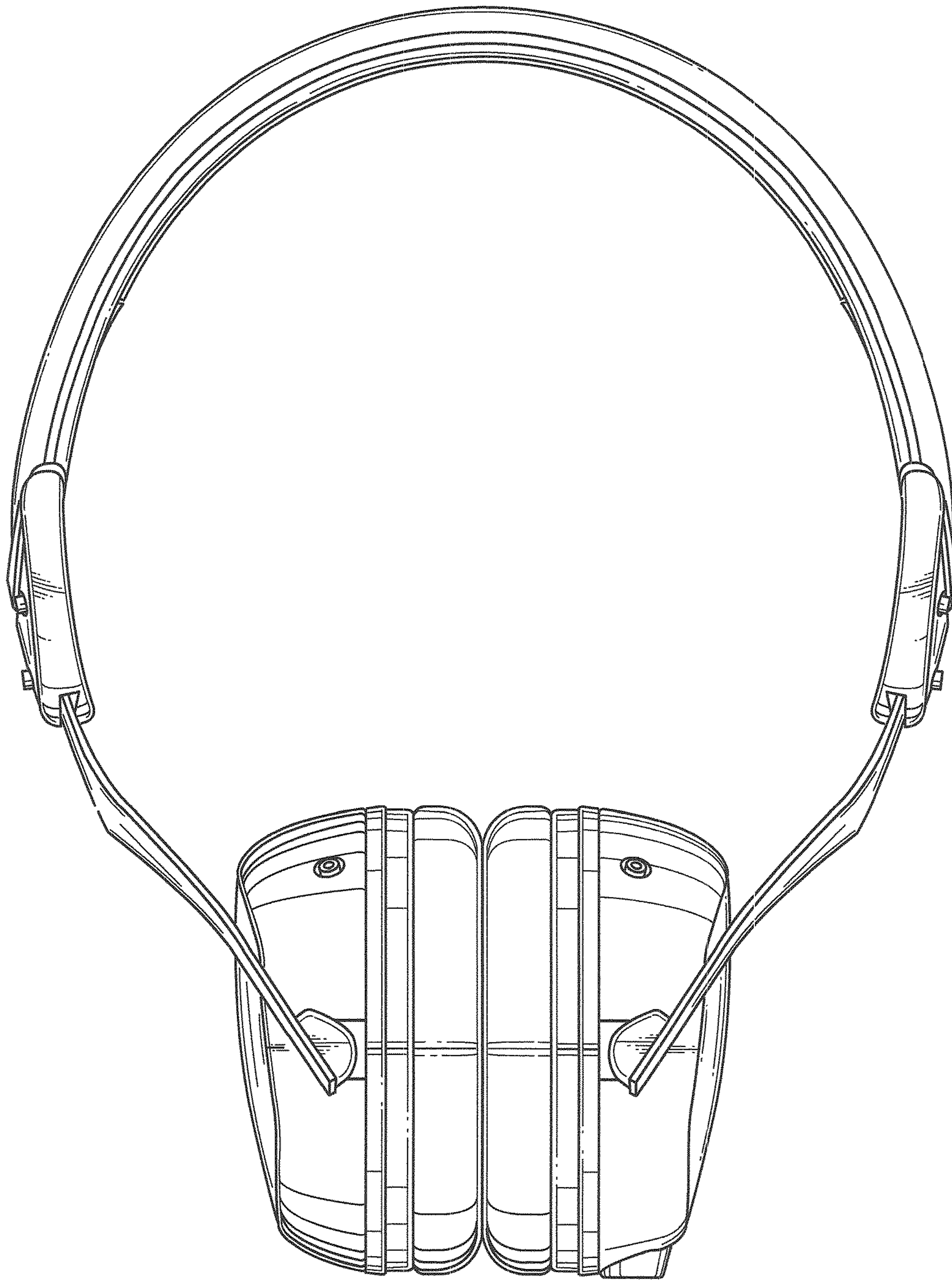

Fig. 6

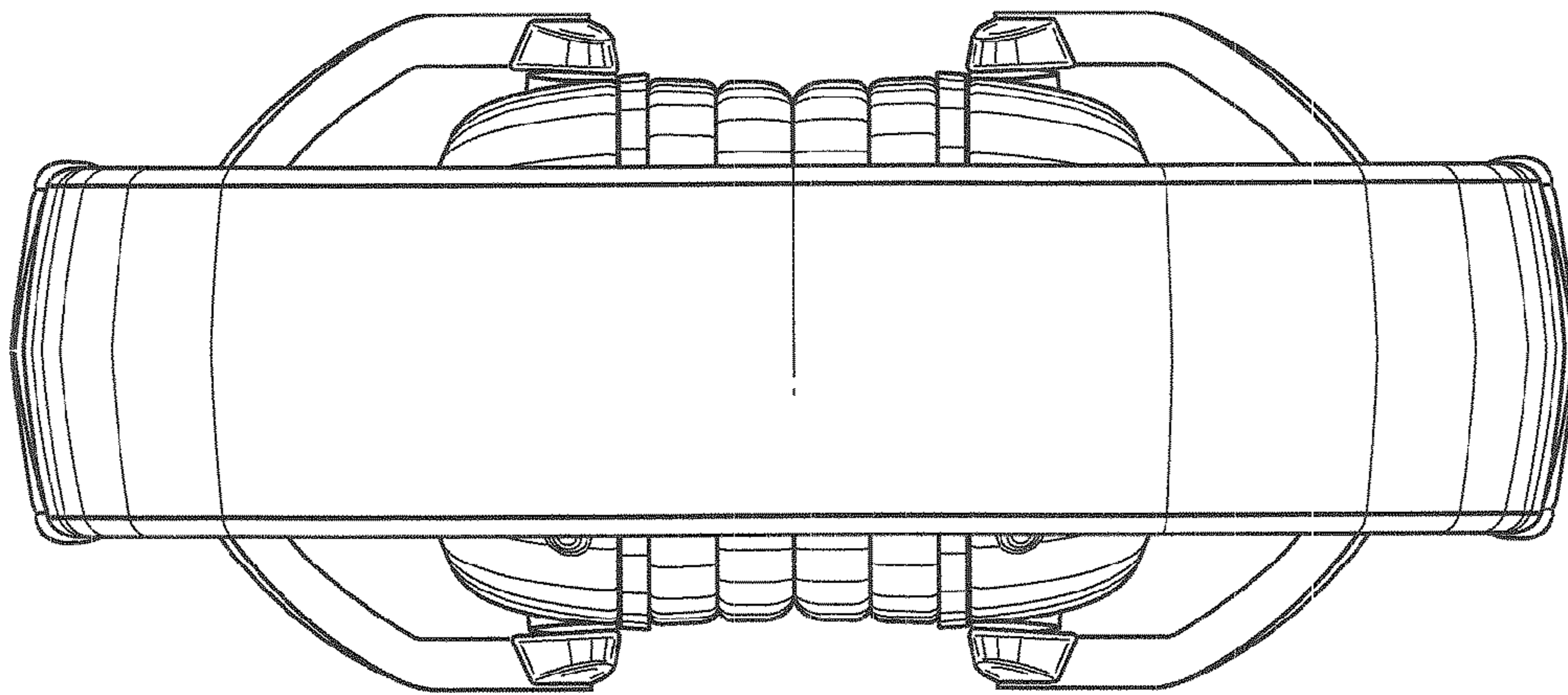

Fig. 7