



US00D645443S

(12) **United States Design Patent**
Maruyama et al.

(10) **Patent No.:** **US D645,443 S**

(45) **Date of Patent:** **** Sep. 20, 2011**

(54) **REPEATER FOR COMMUNICATION**

(75) Inventors: **Kazuhiro Maruyama**, Kyoto (JP);
Kouzou Kamimura, Kyoto (JP)

(73) Assignee: **Nintendo Co., Ltd.**, Kyoto (JP)

(**) Term: **14 Years**

(21) Appl. No.: **29/309,574**

(22) Filed: **Sep. 5, 2008**

(30) **Foreign Application Priority Data**

Mar. 7, 2008 (JP) 2008-005647

(51) **LOC (9) Cl.** **14-03**

(52) **U.S. Cl.** **D14/140.1**

(58) **Field of Classification Search** D14/140,
D14/140.1, 140.4, 140.6, 188, 240, 242, 356,
D14/358, 349, 496; D10/104, 106; D13/123,
D13/147, 152; 379/338-349, 413.02, 413.04;
455/569.1

See application file for complete search history.

(56) **References Cited**

U.S. PATENT DOCUMENTS

D355,196 S *	2/1995	Nakamura	D14/140.4
D471,540 S *	3/2003	Tomino et al.	D14/240
D471,882 S *	3/2003	Lan	D14/125
D489,720 S *	5/2004	Sasaki	D14/358
D495,311 S *	8/2004	Taniguchi et al.	D14/140.1
D502,684 S	3/2005	Koshiishi		
D505,133 S	5/2005	Ashida et al.		
D514,118 S *	1/2006	Christianson	D14/496
D514,563 S *	2/2006	Kuramashi et al.	D14/358
D520,453 S	5/2006	Yoneyama et al.		
D525,232 S *	7/2006	Wen	D14/149
D528,112 S *	9/2006	Park et al.	D14/349
D533,148 S *	12/2006	Hong	D14/125
D534,154 S *	12/2006	Shen	D14/188
D538,273 S *	3/2007	Liu	D14/240
D540,320 S *	4/2007	Noda et al.	D14/349
D541,274 S *	4/2007	Wang	D14/356
D552,549 S *	10/2007	Hsu	D13/133
D555,587 S	11/2007	Yamamoto et al.		

D556,835 S	12/2007	Ashida et al.		
D556,836 S	12/2007	Ashida et al.		
D559,841 S *	1/2008	Liu et al.	D14/240
D563,953 S *	3/2008	Tosh et al.	D14/349

(Continued)

OTHER PUBLICATIONS

AP311W 802.11g Universal Wireless Repeater, <URL:http://www.airlink101.com/products/ap311w.php>, retrieved from internet Jan. 16, 2011.*

(Continued)

Primary Examiner — Rob Spear

Assistant Examiner — Carla Wright

(74) *Attorney, Agent, or Firm* — Nixon & Vanderhye, P.C.

(57) **CLAIM**

The ornamental design for a repeater for communication, as shown and described.

DESCRIPTION

FIG. 1 is a front, top and right side perspective view of a repeater for communication showing our new design with the bottom stands in a stored condition;

FIG. 2 is a rear, bottom and left perspective view thereof;

FIG. 3 is a front view thereof;

FIG. 4 is a rear view thereof;

FIG. 5 is a top plan view thereof;

FIG. 6 is a bottom plan view thereof;

FIG. 7 is a right side view thereof, a left side view being a mirror image thereof; FIG. 8 is a front, top and right side perspective view thereof with the bottom stands in an extended condition;

FIG. 9 is a rear, bottom and left perspective view thereof;

FIG. 10 is a front view thereof;

FIG. 11 is a rear view thereof;

FIG. 12 is a top plan view thereof;

FIG. 13 is a bottom plan view thereof; and,

FIG. 14 is a right side view thereof, a left side view being a mirror image thereof.

1 Claim, 10 Drawing Sheets

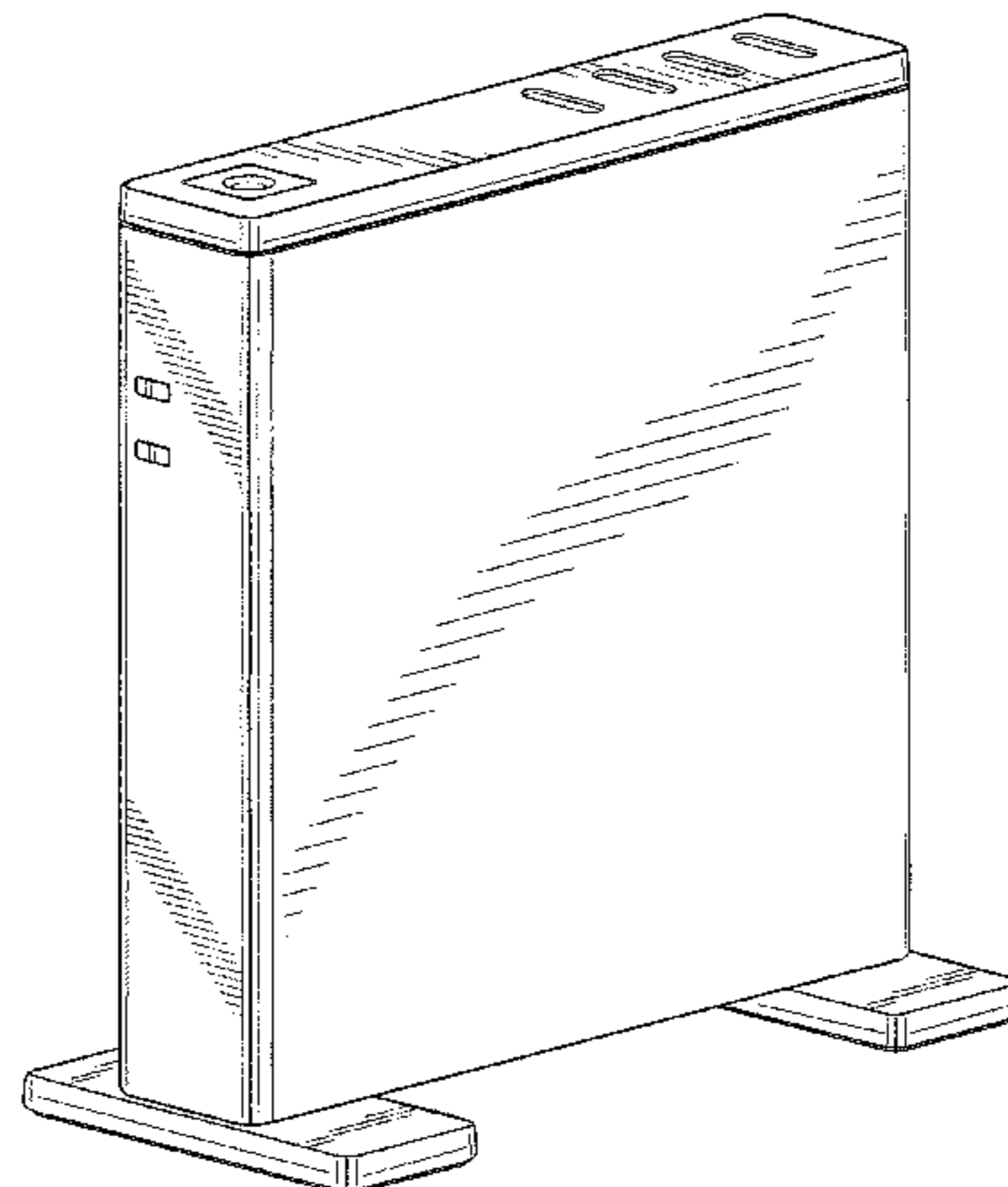
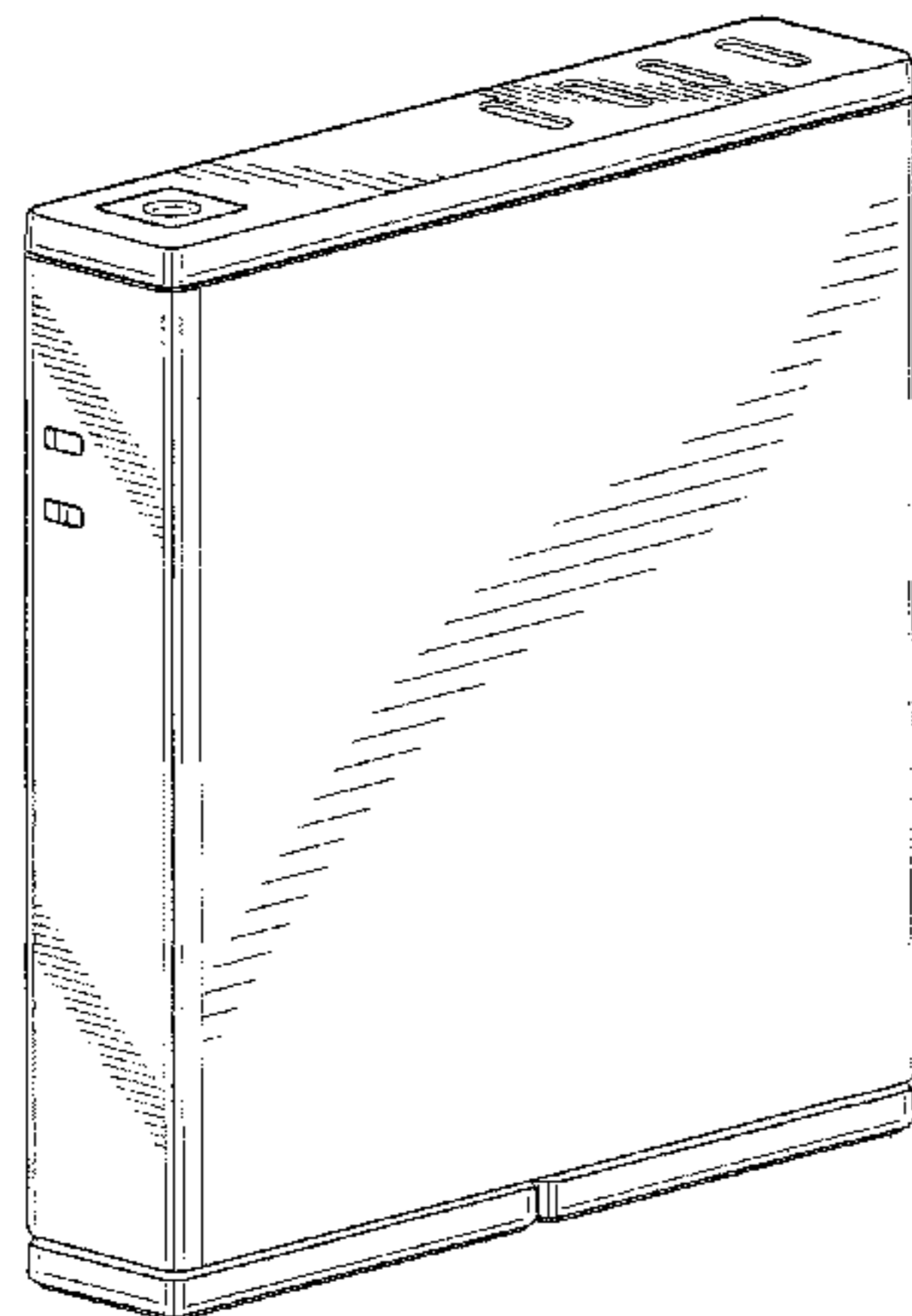

US D645,443 S

Page 2

U.S. PATENT DOCUMENTS

D568,315 S * 5/2008 Yano D14/358
D576,686 S 9/2008 Ashida et al.
D580,423 S * 11/2008 Ju D14/240
D583,814 S * 12/2008 Maiers et al. D14/356
D585,059 S * 1/2009 Maiers et al. D14/356
D593,082 S * 5/2009 Jeon D14/240
D595,280 S * 6/2009 Chiba et al. D14/240
D603,834 S * 11/2009 Lyman et al. D14/155
D622,713 S * 8/2010 Chung et al. D14/242
2006/0152899 A1 * 7/2006 Wang 361/685

OTHER PUBLICATIONS

WR200—Visonic Two Output Wireless Receiver, <URL:<http://www.homesecuritystore.com/p-1614-wr200-visonic-two-output-wireless-receiver.aspx>>, retrieved from internet Jan. 16, 2011.*

* cited by examiner

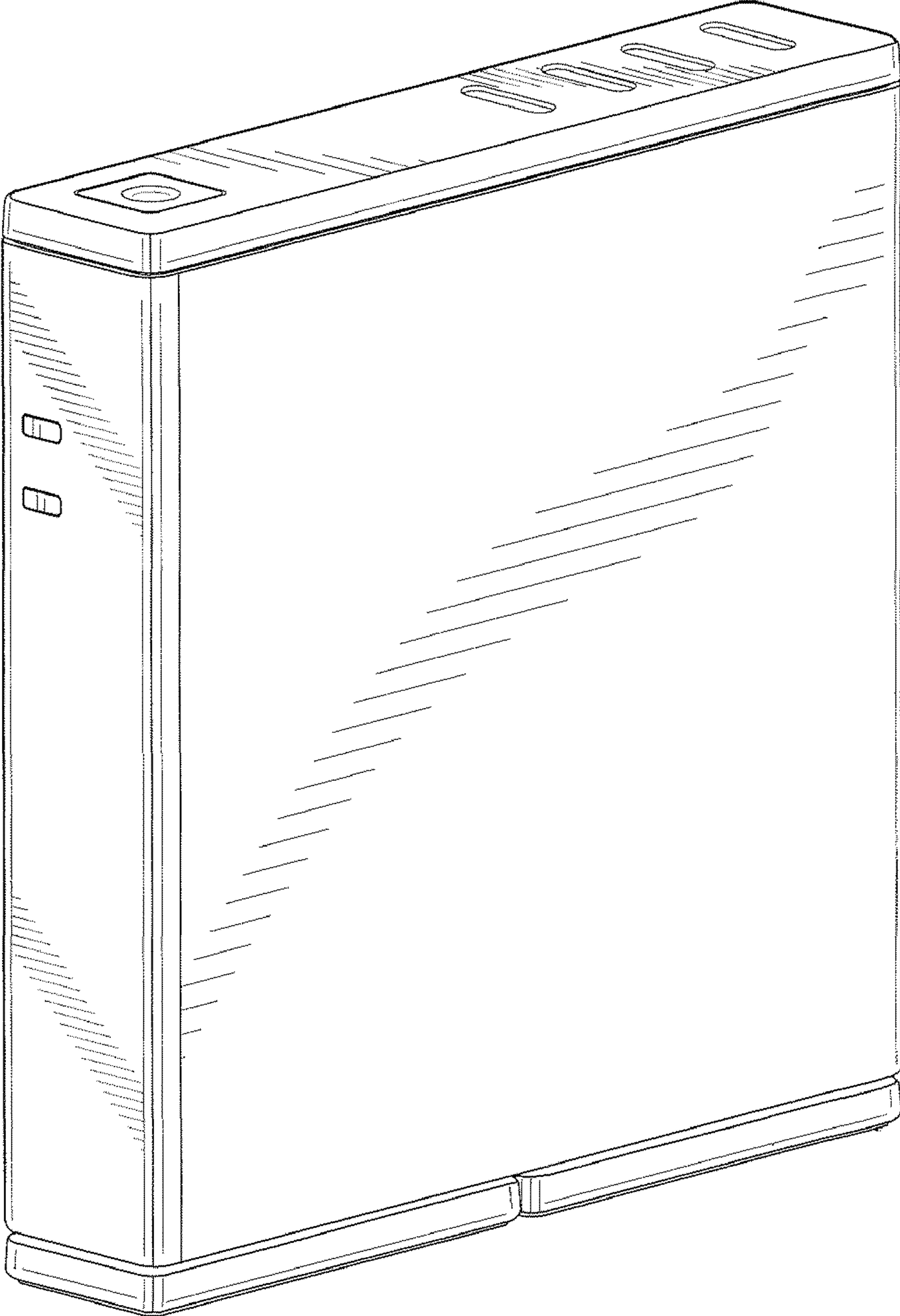

FIG.1

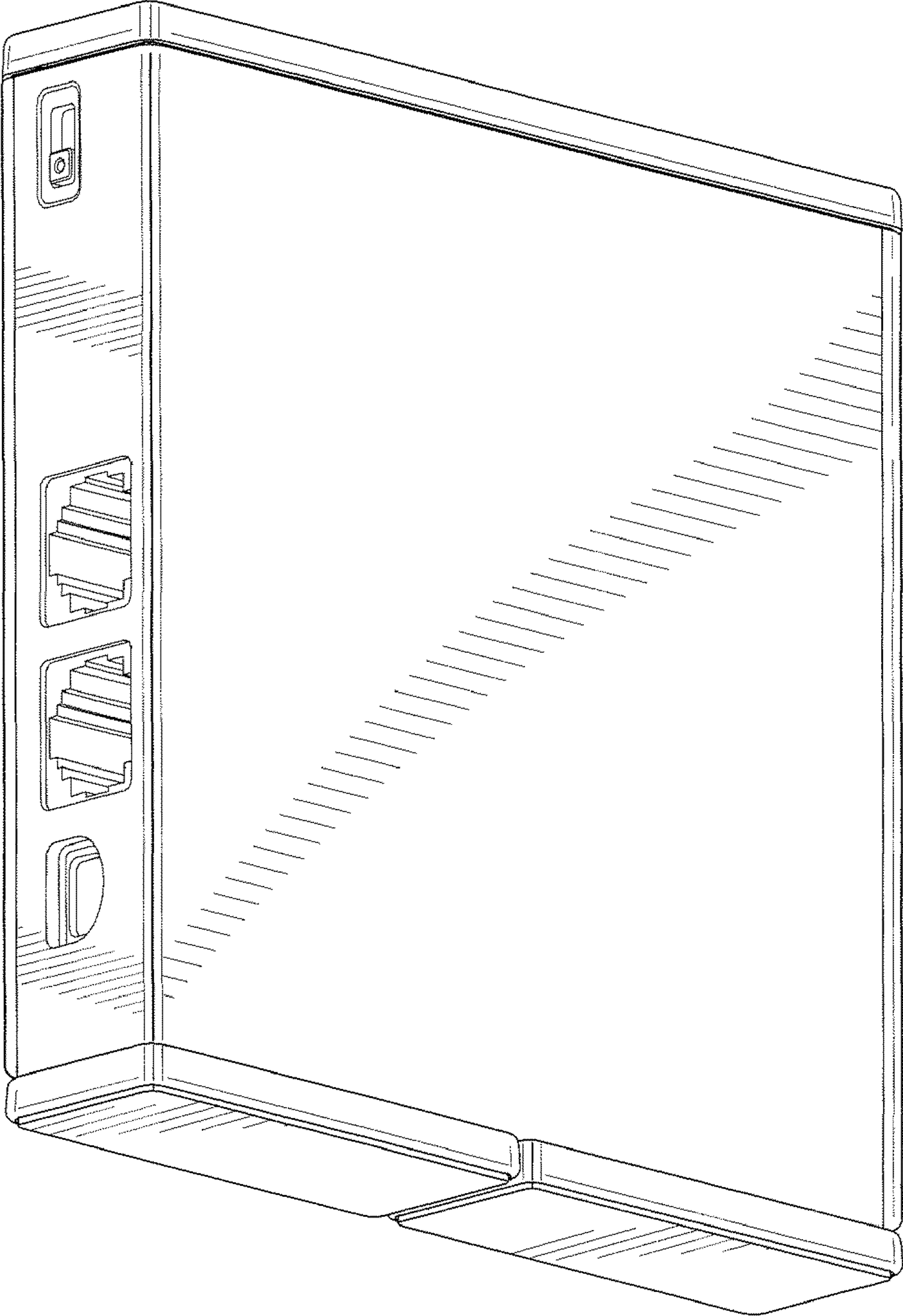

FIG.2

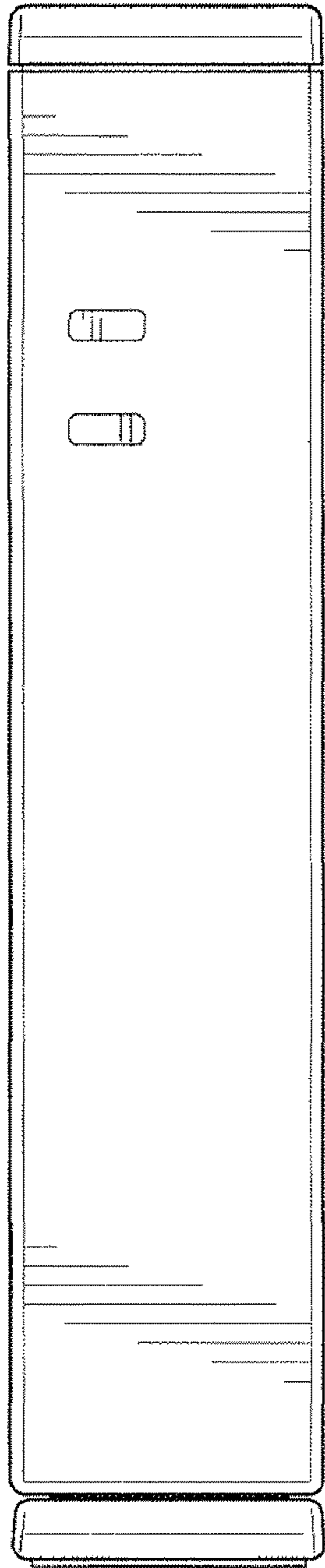

FIG.3

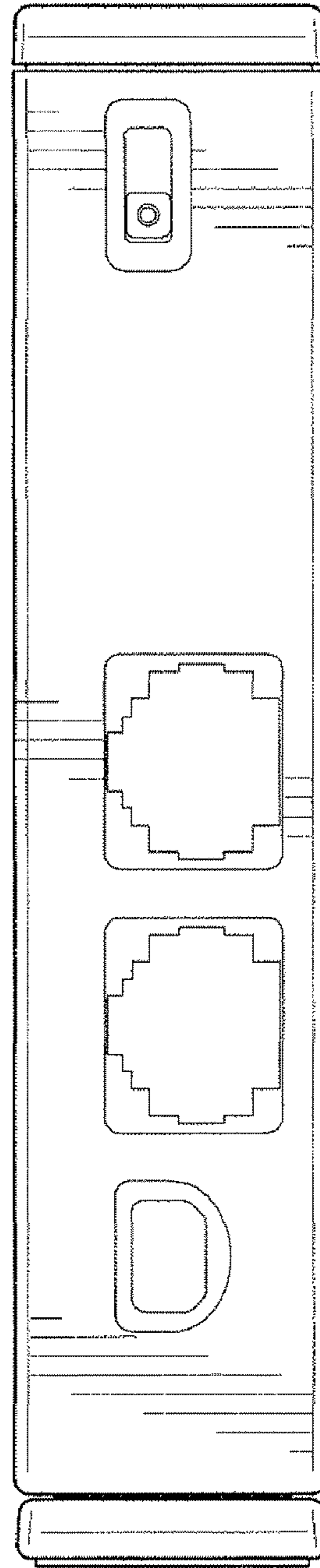

FIG.4

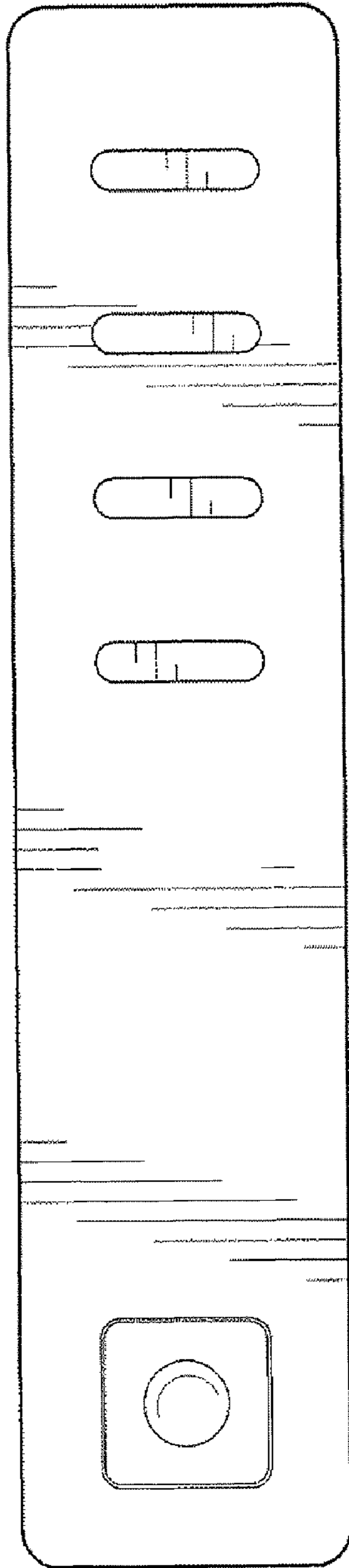

FIG. 5

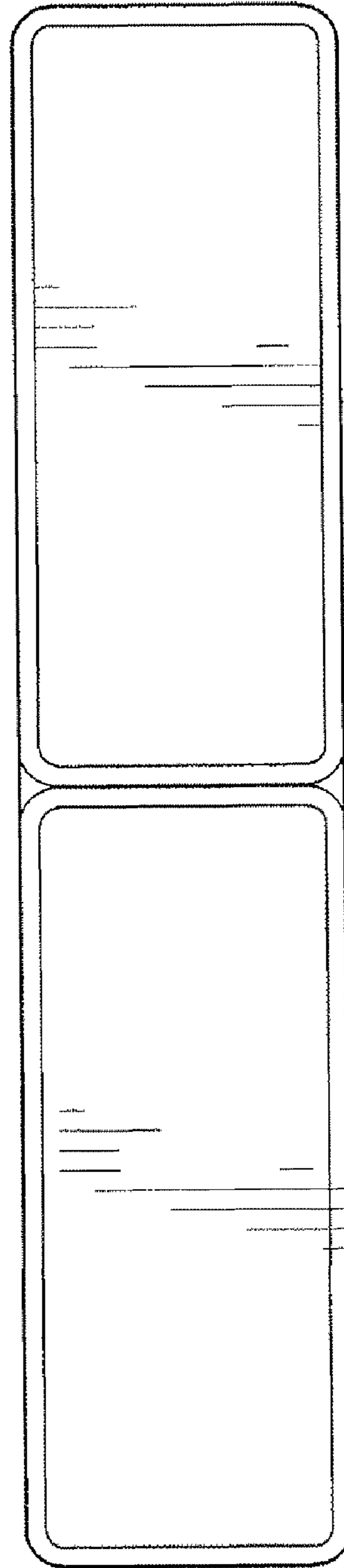

FIG. 6

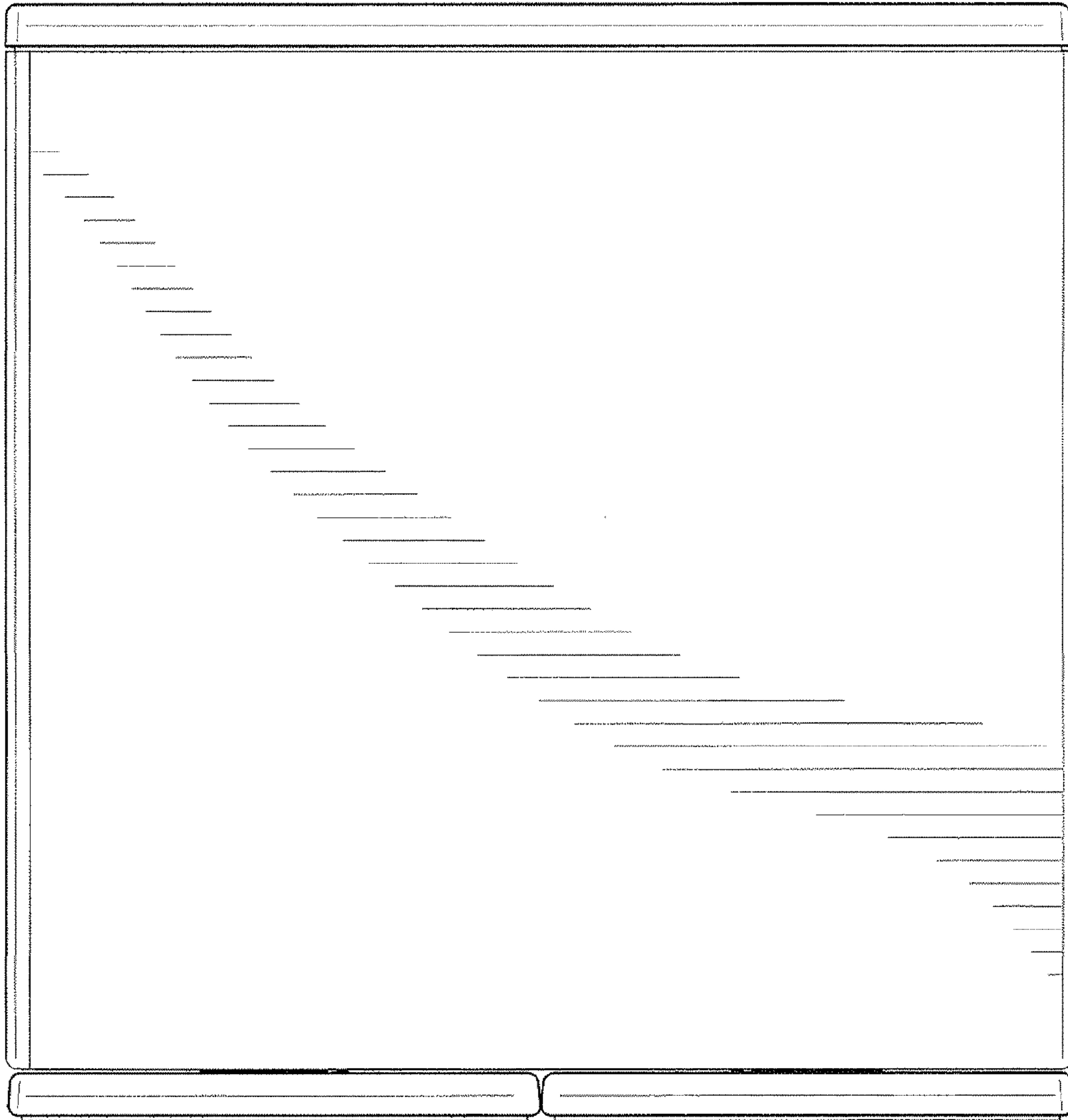

FIG. 7

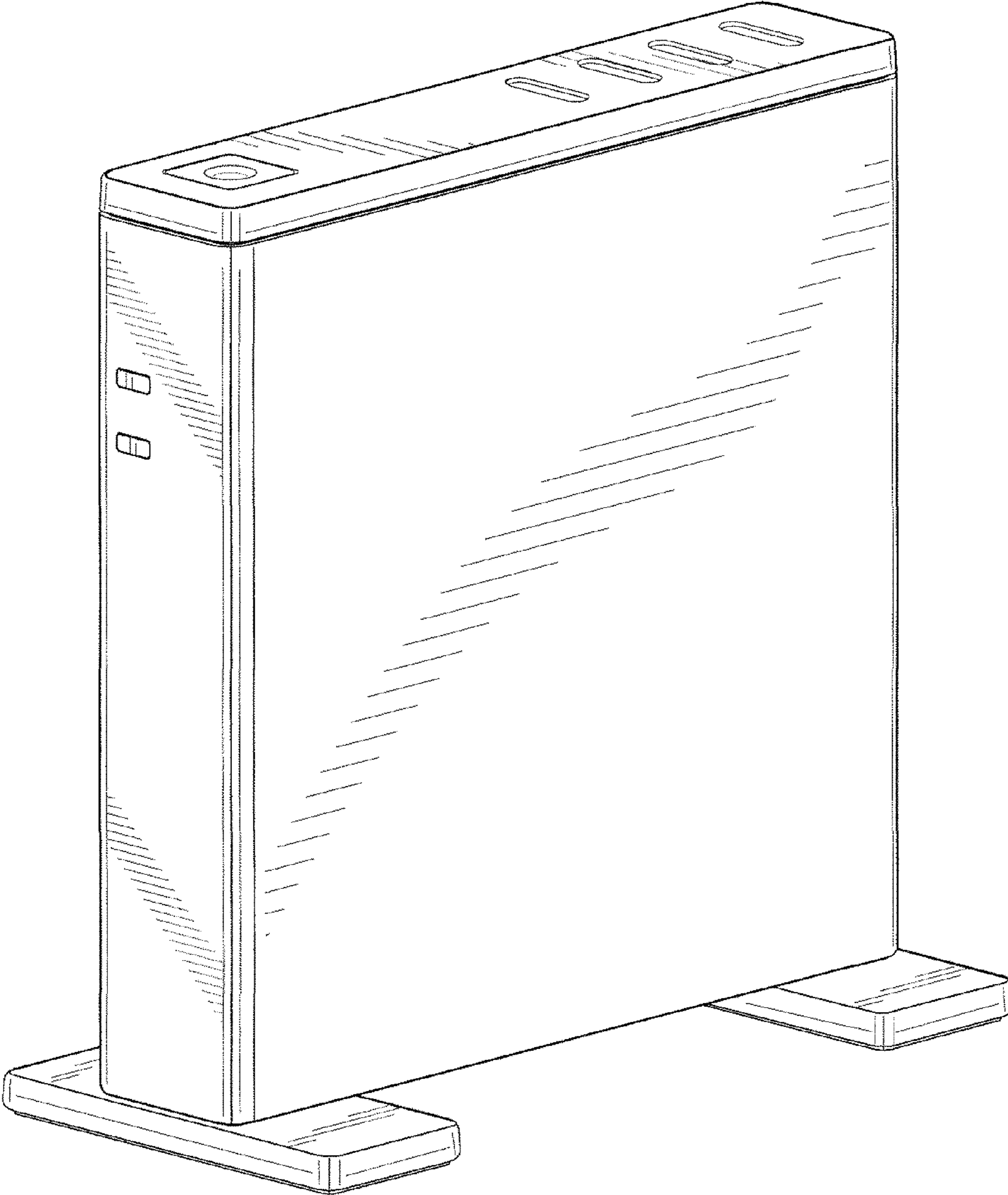

FIG.8

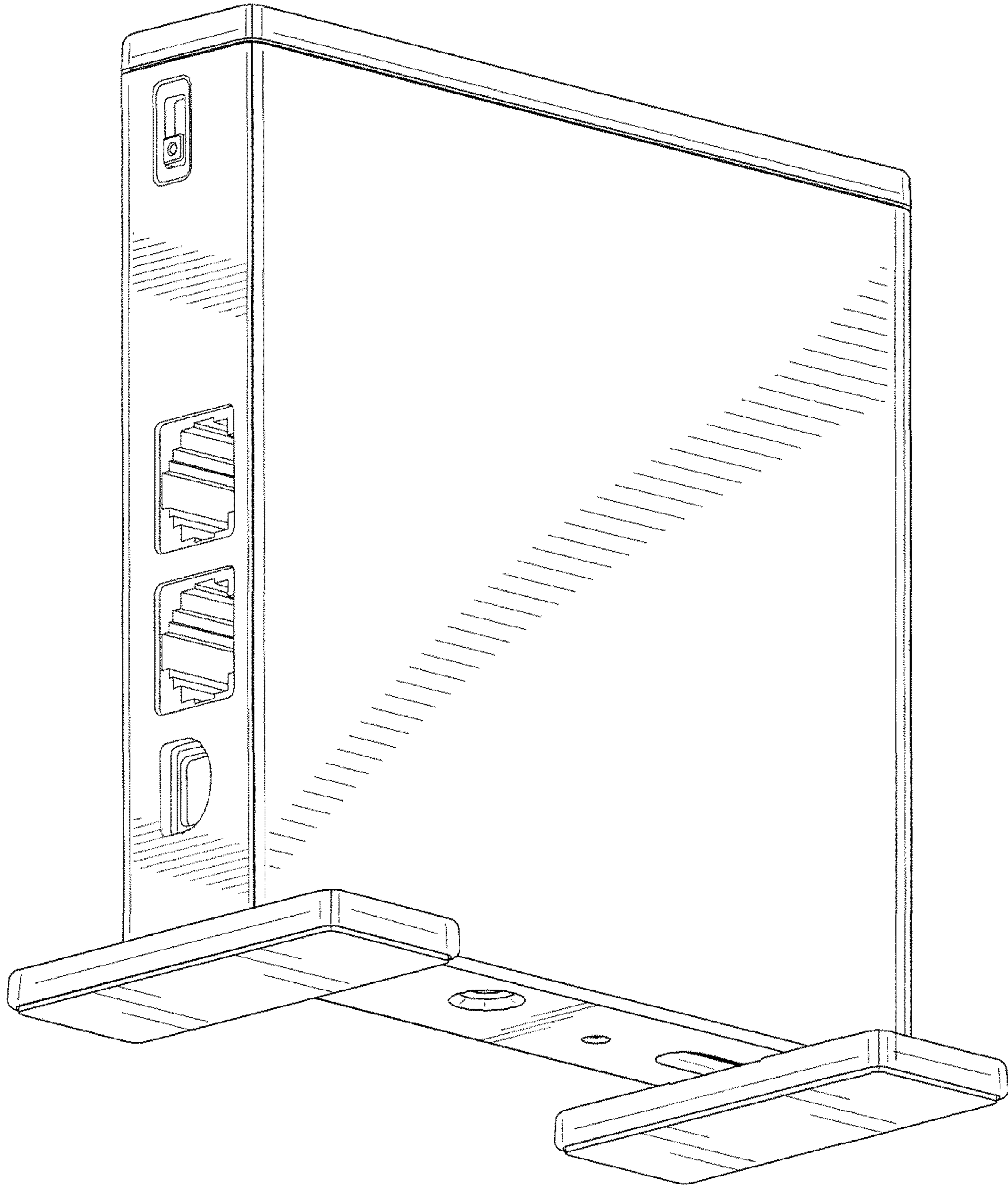

FIG.9

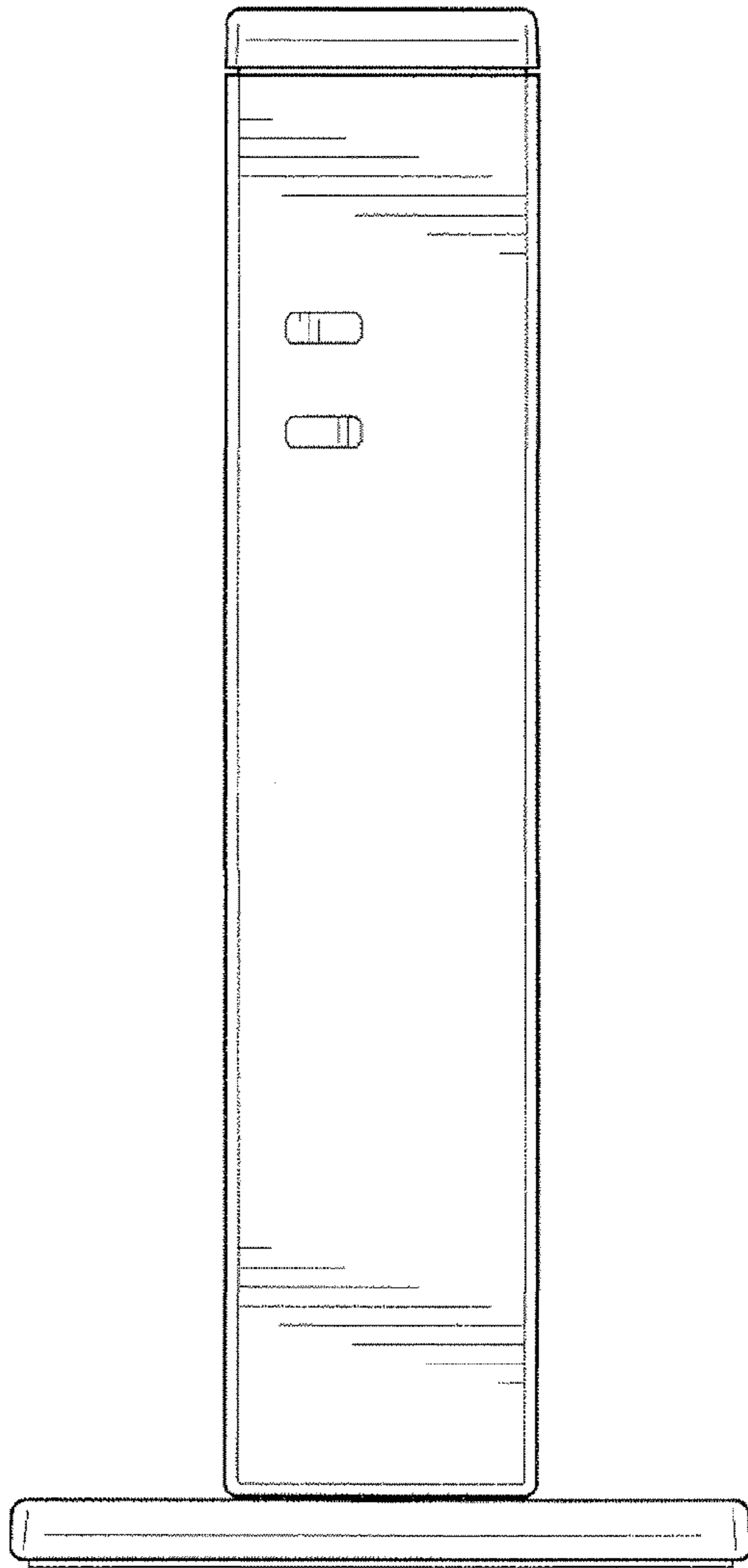

FIG. 10

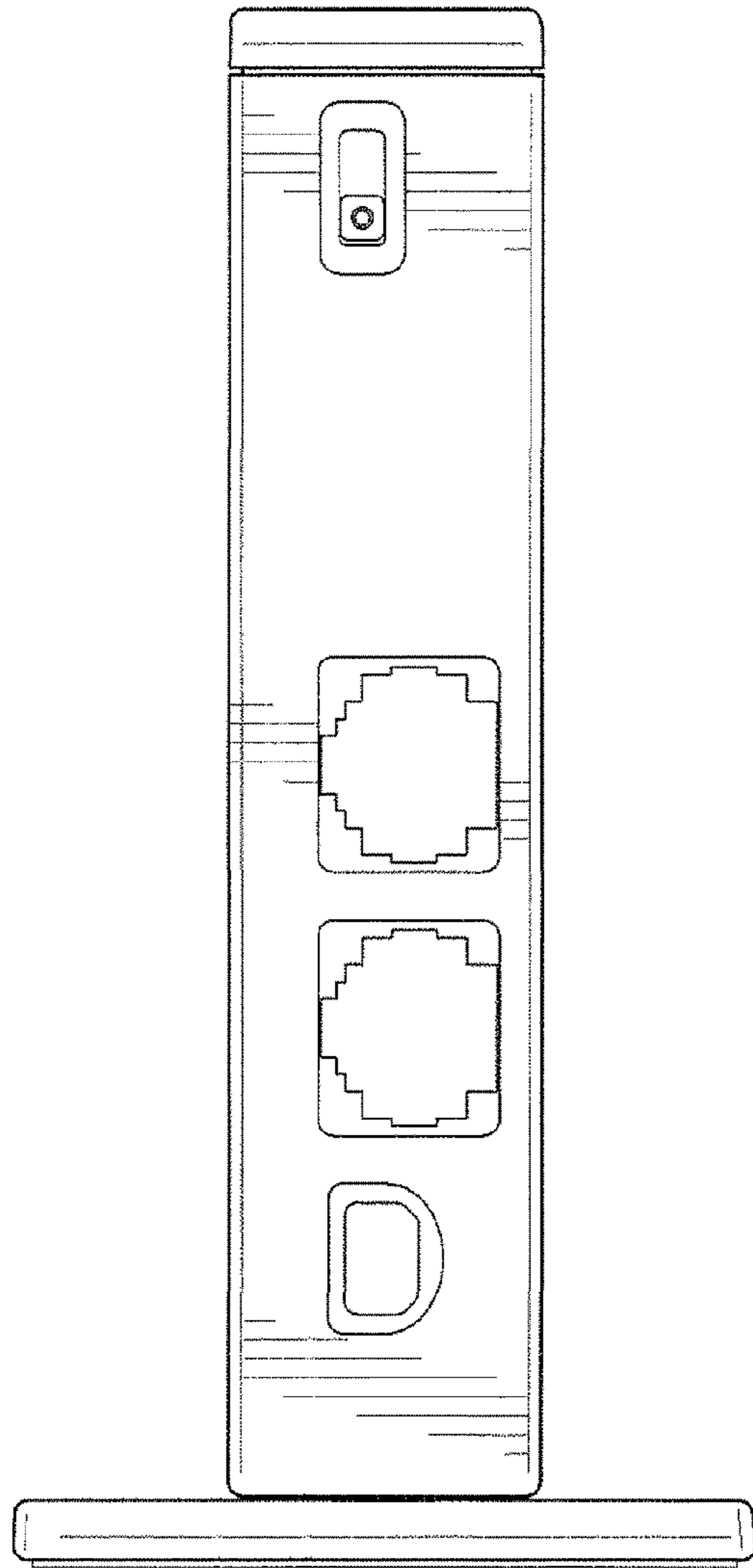

FIG. 11

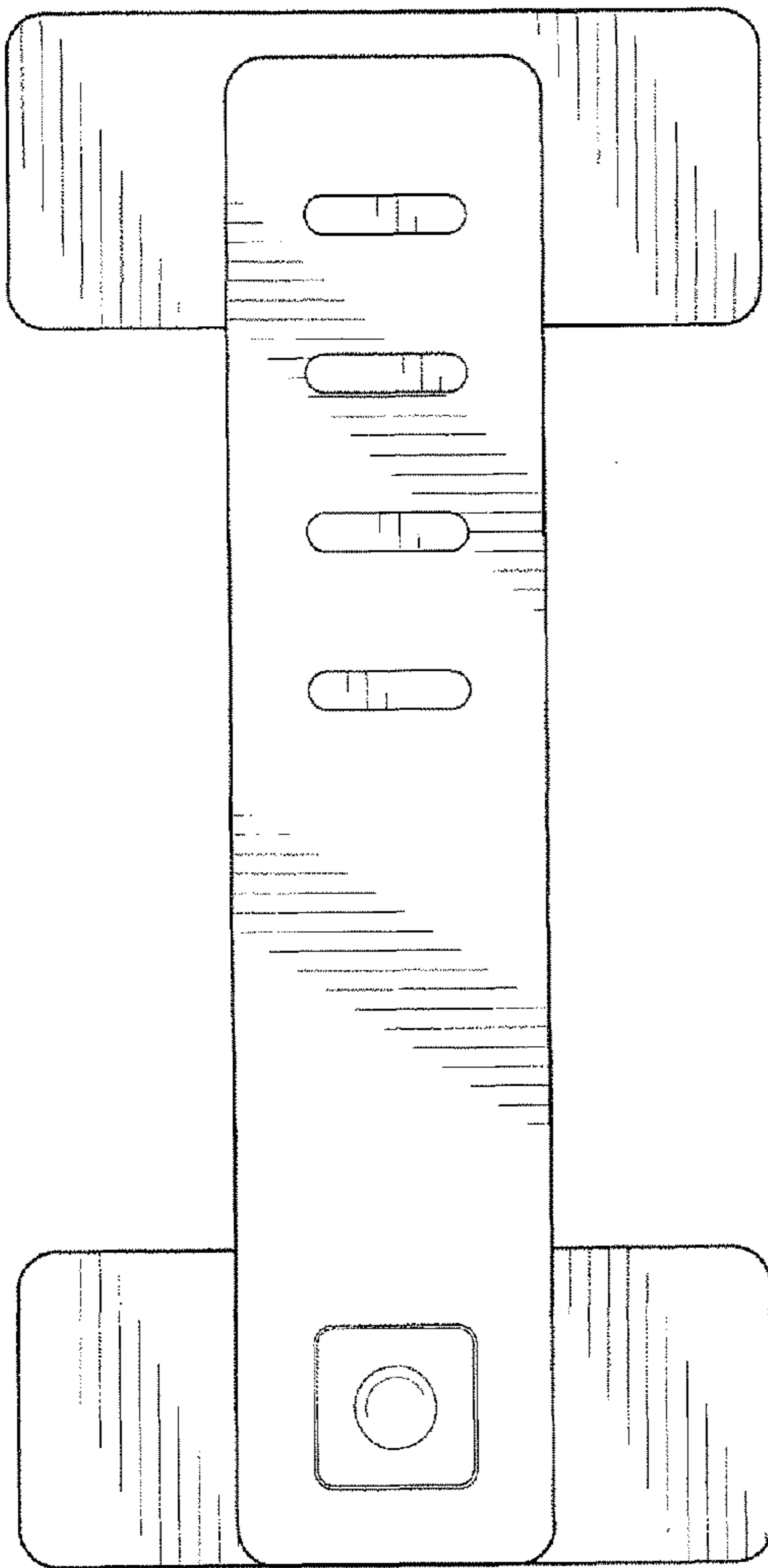

FIG. 12

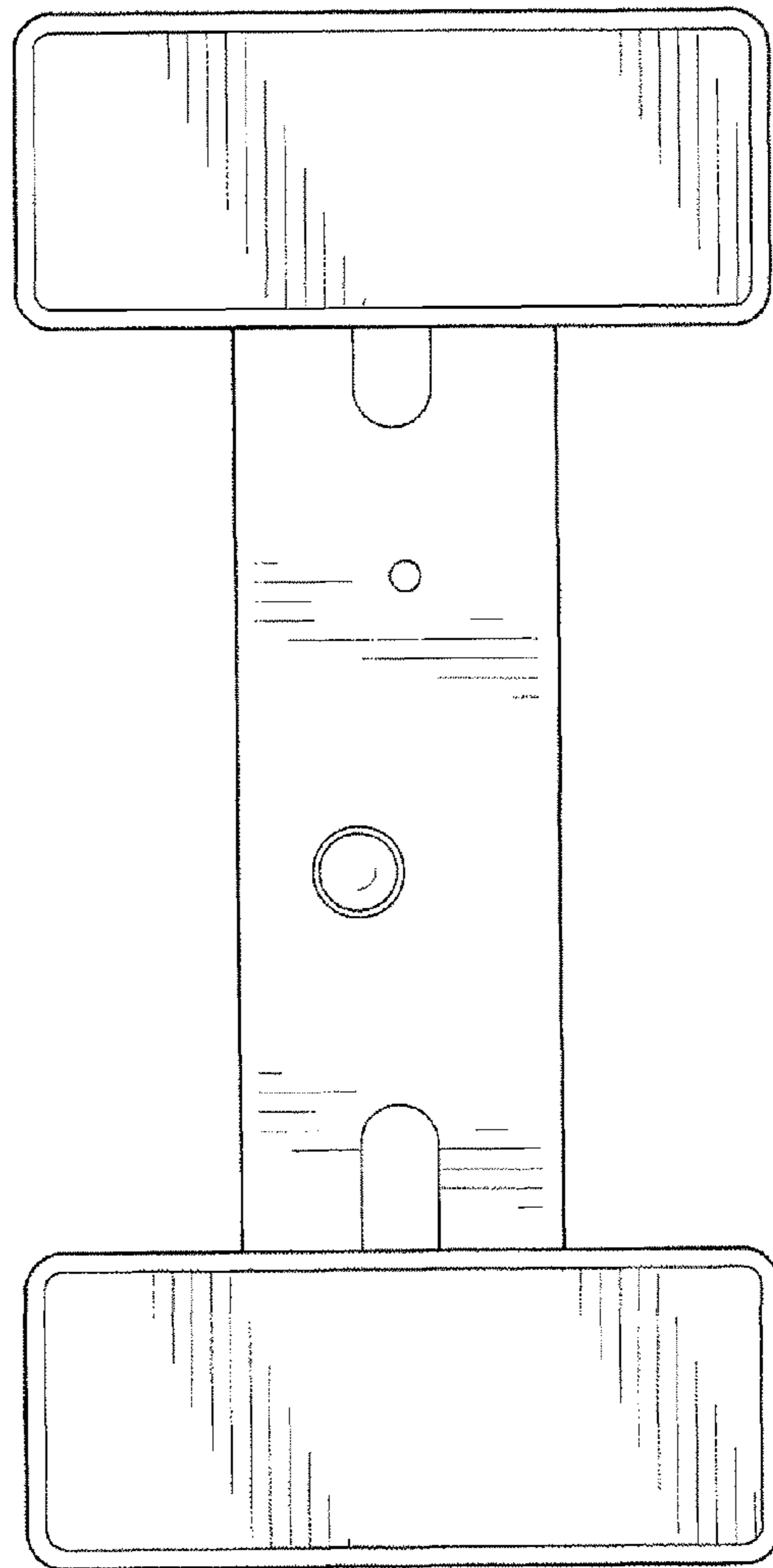

FIG. 13

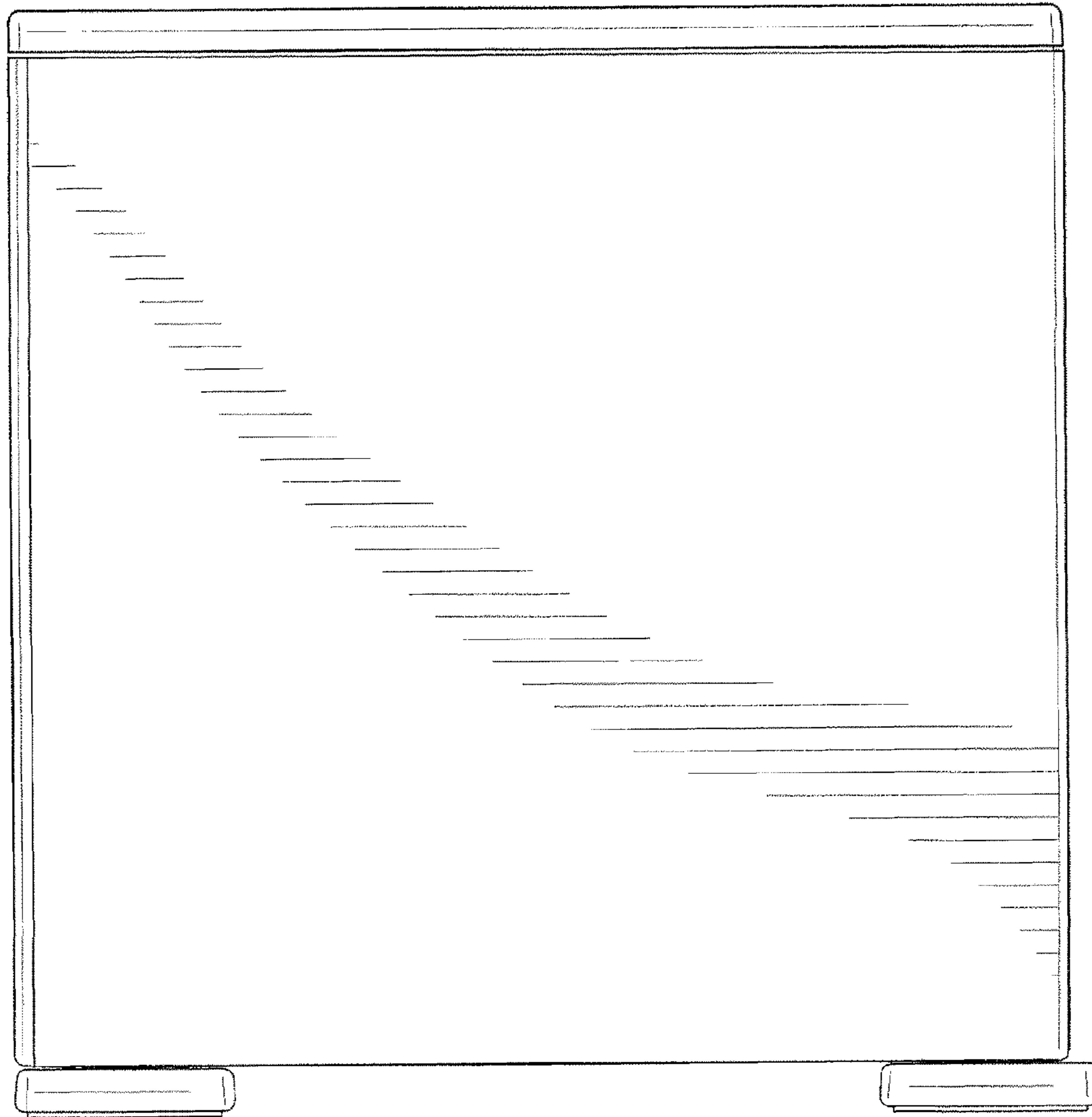

FIG.14