



US00D645439S

(12) **United States Design Patent**
Lee et al.

(10) **Patent No.:** **US D645,439 S**

(45) **Date of Patent:** **** Sep. 20, 2011**

(54) **MOBILE PHONE**

(75) Inventors: **Ji-Young Lee**, Seoul (KR); **Min-Hyounk Lee**, Seoul (KR)

(73) Assignee: **Samsung Electronics Co., Ltd.**, Suwon-Si (KR)

(**) **Term:** **14 Years**

(21) **Appl. No.:** **29/380,507**

(22) **Filed:** **Dec. 7, 2010**

(30) **Foreign Application Priority Data**

Sep. 16, 2010 (KR) 30-2010-0041063

(51) **LOC (9) Cl.** **14-03**

(52) **U.S. Cl.** **D14/138 AD**

(58) **Field of Classification Search** D14/138 R,
D14/138 AD, 138 AC, 138 C, 138 G, 191,
D14/203.1–203.8, 496, 138 AA, 138 AB,
D14/137, 147, 218, 341–347, 247–248; D10/65,
D10/78, 104; D13/168; D18/7; 455/566,
455/575.1, 575.3, 575.4

See application file for complete search history.

(56) **References Cited**

U.S. PATENT DOCUMENTS

D531,611 S * 11/2006 Kim et al. D14/138 AD
7,269,450 B2 * 9/2007 Lee et al. 455/575.1
D555,616 S * 11/2007 Lin D14/138 AD
D585,040 S * 1/2009 Kim et al. D14/138 G
D589,487 S * 3/2009 Park et al. D14/138 AD
D590,802 S * 4/2009 Shin et al. D14/138 AD
D596,608 S * 7/2009 Kim et al. D14/138 G
D601,988 S * 10/2009 Bang et al. D14/138 G
D605,156 S * 12/2009 Kim et al. D14/138 AB
D605,621 S * 12/2009 Kim et al. D14/138 AD
D611,443 S * 3/2010 Suk et al. D14/138 AD
D611,921 S * 3/2010 Bang et al. D14/138 G
D615,945 S * 5/2010 Kim et al. D14/138 G
D617,758 S * 6/2010 Zhao D14/138 AD

D619,988 S * 7/2010 Ji et al. D14/138 G
D620,470 S * 7/2010 Sohn et al. D14/138 AD
D625,699 S * 10/2010 Huang et al. D14/138 G
D629,773 S * 12/2010 Lee et al. D14/138 G
D629,782 S * 12/2010 Kim et al. D14/138 G
D631,456 S * 1/2011 Chung et al. D14/138 G
D631,461 S * 1/2011 Yuan D14/138 G
D635,115 S * 3/2011 Li D14/138 G
D635,562 S * 4/2011 Fan et al. D14/248
D636,365 S * 4/2011 Cheng et al. D14/138 G

OTHER PUBLICATIONS

HTC Desire Z, announced Sep. 2010, [online], [retrieved on Sep. 29, 2010]. Retrieved from Internet ,<URL: <http://www.gsmarena.com>>.*

T-Mobile G2, announced Sep. 2010, [online], [retrieved on Sep. 30, 2010]. Retrieved from Internet ,<URL: <http://www.gsmarena.com>>.*

Eten glofiish X610, announced Jun. 2008, [online], [retrieved on Jun. 13, 2008]. Retrieved from Internet ,<URL: <http://www.gsmarena.com>>.*

* cited by examiner

Primary Examiner — Bridget L Eland

(74) *Attorney, Agent, or Firm* — Staas & Halsey LLP

(57) **CLAIM**

The ornamental design for a mobile phone, as shown and described.

DESCRIPTION

FIG. 1 is a front perspective view of a mobile phone;
FIG. 2 is a front view of the mobile phone of FIG. 1;
FIG. 3 is a rear view of the mobile phone of FIG. 1;
FIG. 4 is a left-side view of the mobile phone of FIG. 1;
FIG. 5 is a right-side view of the mobile phone of FIG. 1;
FIG. 6 is a top plan view of the mobile phone of FIG. 1;
FIG. 7 is a bottom plan view of the mobile phone of FIG. 1;
and,
FIG. 8 is an open front perspective view of the mobile phone of FIG. 1.

1 Claim, 8 Drawing Sheets

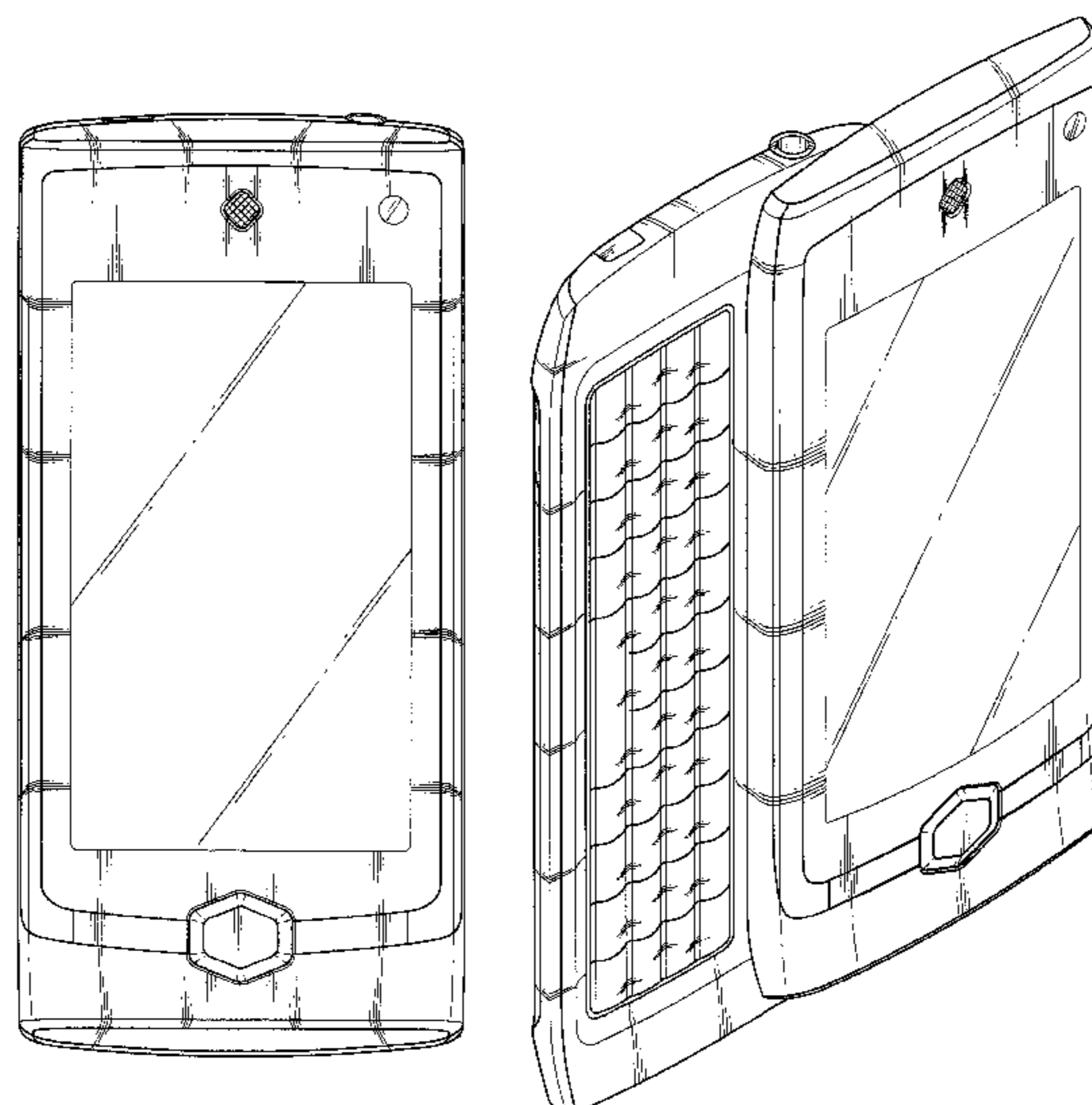

FIG. 1

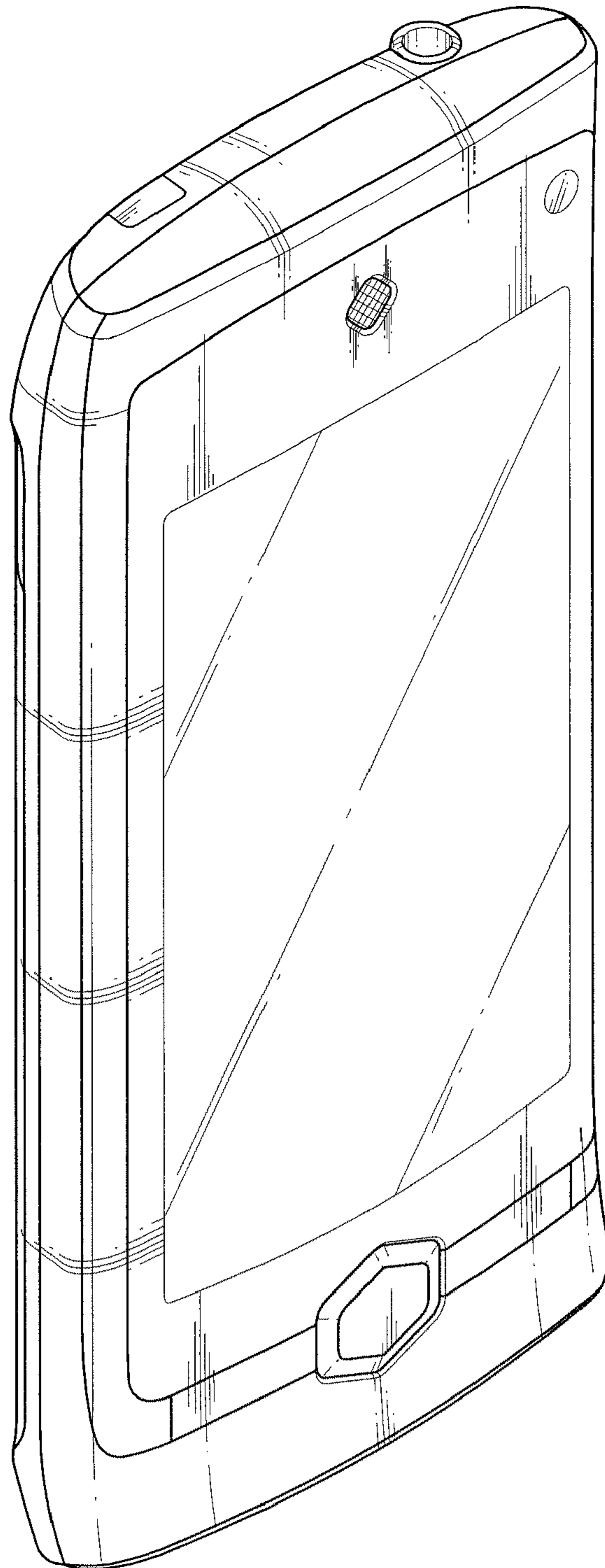

FIG. 2

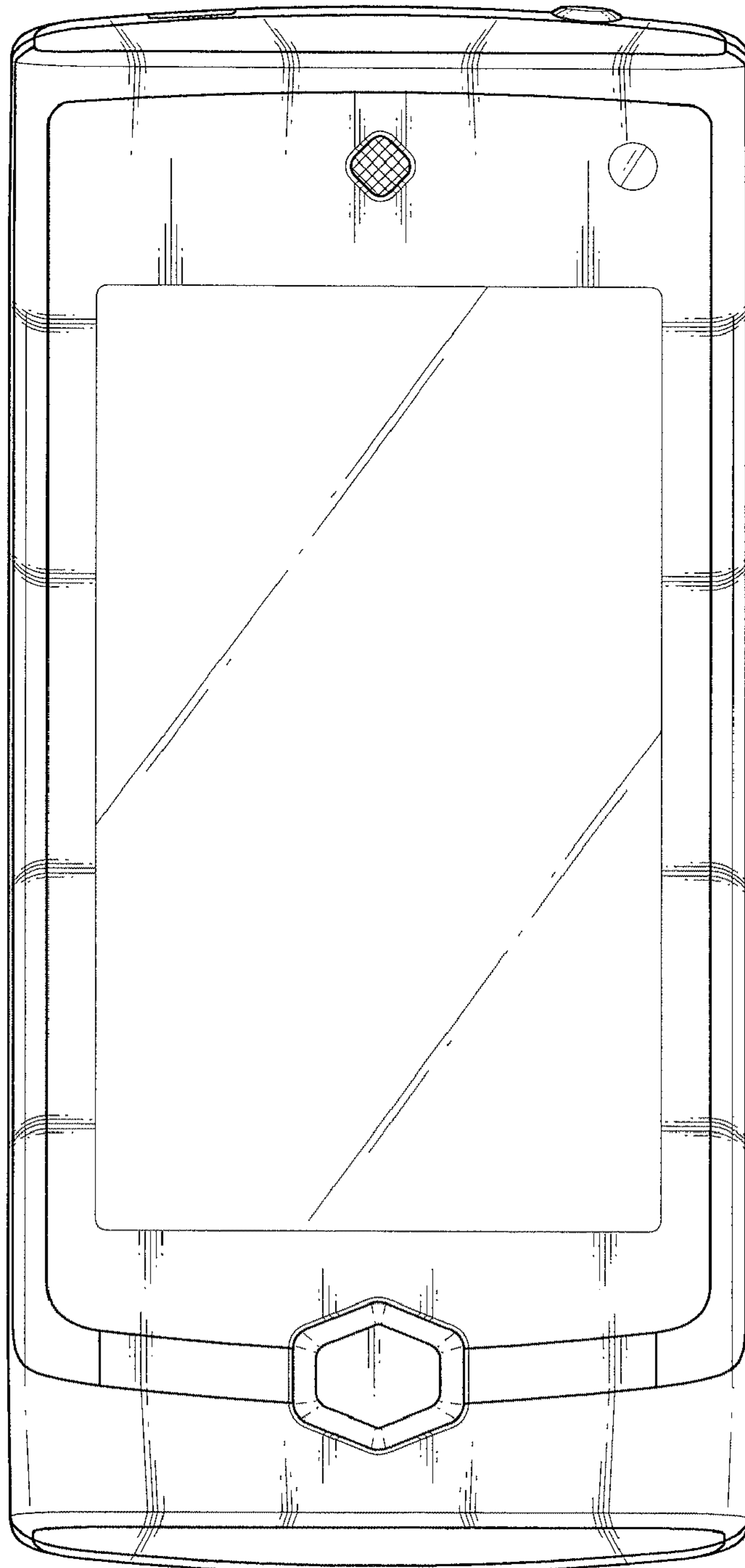

FIG. 3

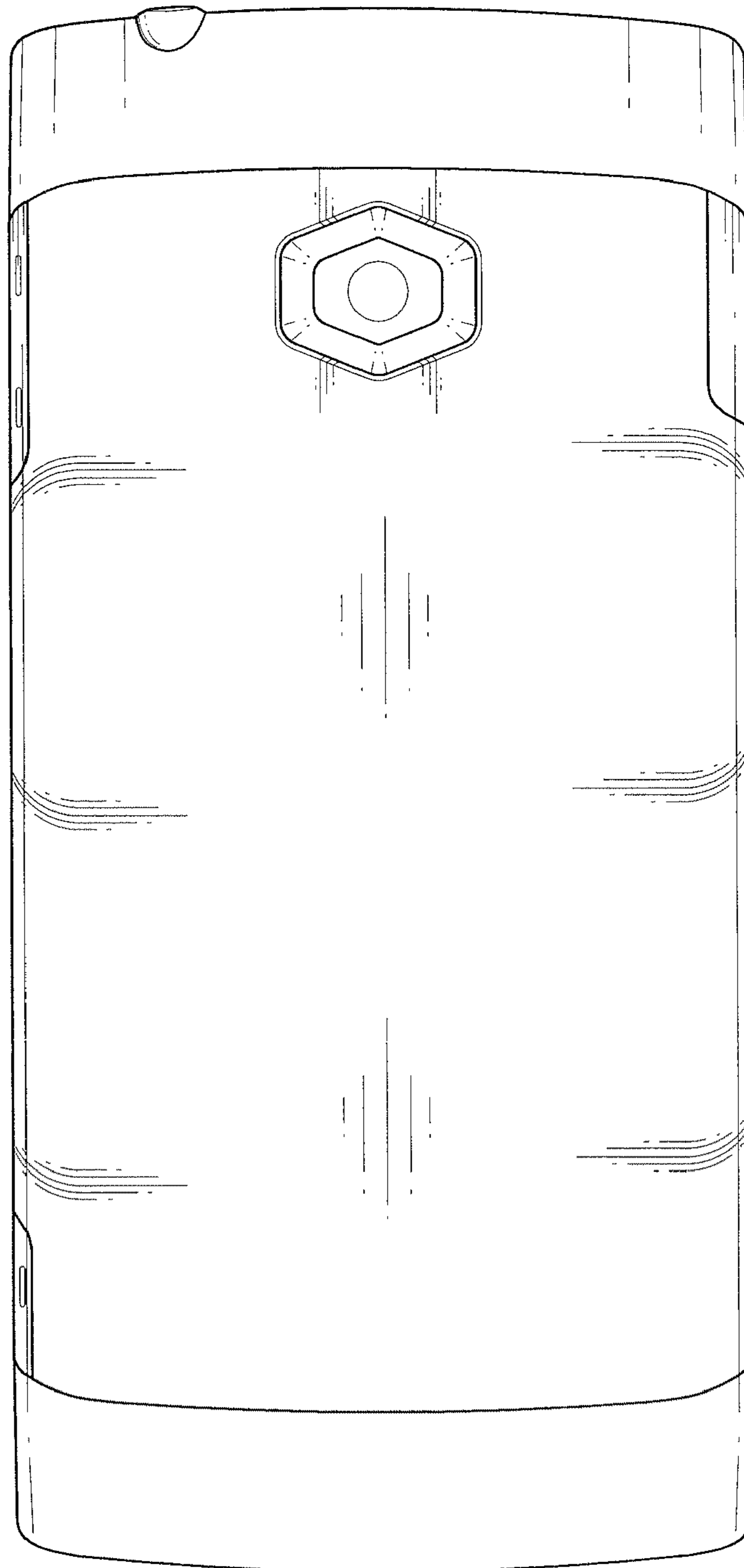

FIG 4

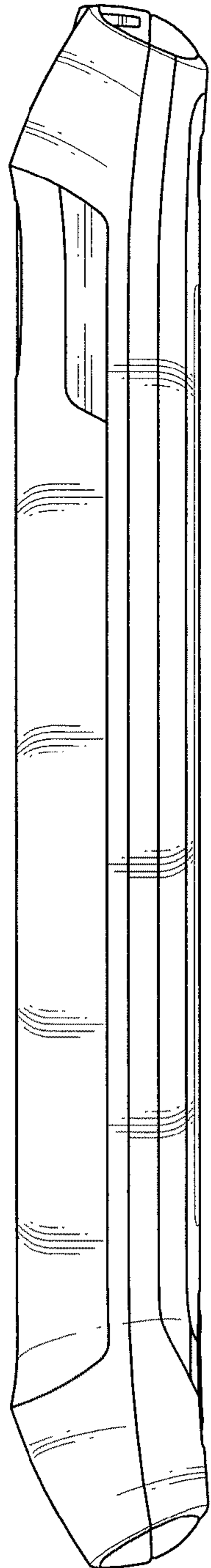

FIG. 5

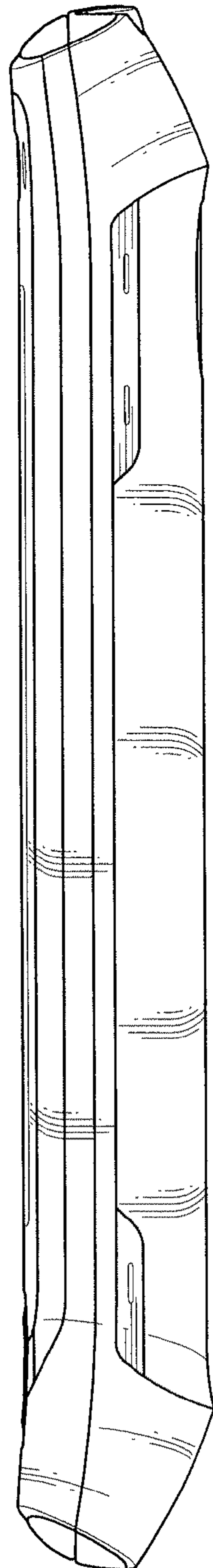

FIG. 6

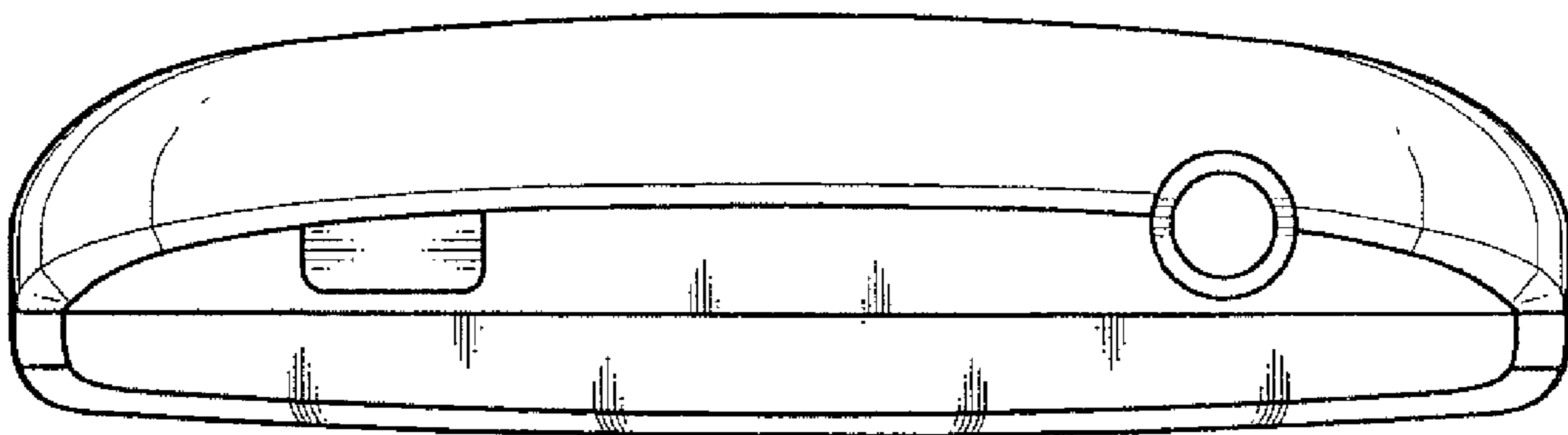

FIG. 7

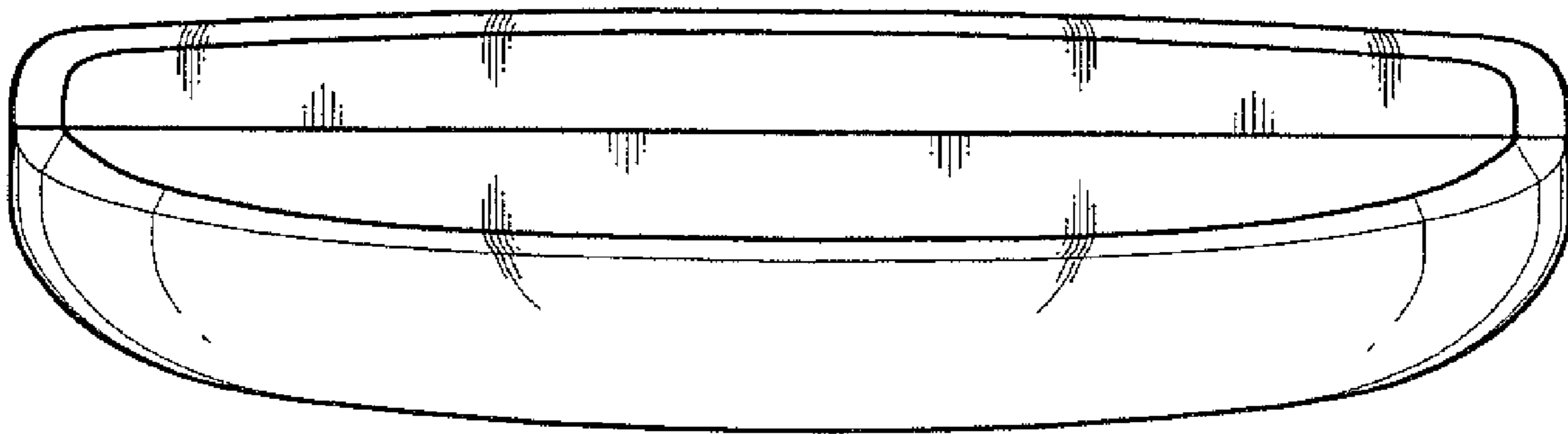

FIG. 8

